



STEELER®

**PROBABLY
THE BEST
DESIGN
IN THE WORLD**



CHEVROLET
CITROEN
DACIA
FIAT
FORD

HONDA
HYUNDAI
ISUZU
JEEP
KIA

LAND ROVER
LEXUS
MERCEDES
MITSUBISHI
NISSAN

OPEL
REANULT
SSANGYONG
SEAT
SKODA

SUBARU
SUZUKI
TOYOTA
VOLKSWAGEN
VOLVO

TABLE OF CONTENTS



CHEVROLET CAPTIVA 2012-2015	5	KIA SPORTAGE 2010-2015	76
CHEVROLET TRAX 2013-	7	KIA SPORTAGE 2015-2018	78
CITROEN JUMPER 2006-2014	8	KIA SPORTAGE 2018-	80
CITROEN JUMPER 2014-2016	9	LAND ROVER FREELANDER II 2007-2014	82
CITROEN BERLINGO VAN 2019-	10	LAND ROVER DISCOVERY V 2017-	84
DACIA DUSTER 2010-2014	11	LEXUS NX F-SPORT 2014-	86
DACIA DUSTER 2014-2018	12	MERCEDES SPRINTER 2006-2013-2018	87
DACIA SANDERO STEPWAY 2012-2016	13	MERCEDES SPRINTER 2018-	88
DACIA DUSTER 2018-	14	MERCEDES V-CLASS 2014-	89
FIAT DUCATO 2006-2014	16	MERCEDES VITO 2003-2010	91
FIAT DUCATO 2014-2016-	17	MERCEDES VITO 2014-	92
FIAT FULLBACK 2015-	18	MERCEDES X-CLASS 2017-	94
FIAT FULLBACK 2015-	20	MITSUBISHI ASX 2010-2013	97
FORD CONNECT 2013-2018-	21	MITSUBISHI ASX 2012-2017	99
FORD COURIER 2014-2018	22	MITSUBISHI ASX 2017-	101
FORD COURIER 2018-	23	MITSUBISHI ECLIPSE CROSS 2017-	103
FORD KUGA 2008-2013	24	MITSUBISHI L200	
FORD KUGA 2012-2017	26	L200- (2006-2009) / L200N- (2009-2015)	105
FORD KUGA 2017-	28	MITSUBISHI L200 2015-2019	107
FORD RANGER 2007-2012	30	MITSUBISHI L200 2019-	110
FORD RANGER 2012-2016	32	MITSUBISHI OUTLANDER 2007-2010	113
FORD RANGER 2016-2019	34	MITSUBISHI OUTLANDER 2010-2012	115
FORD RANGER 2019-	36	MITSUBISHI OUTLANDER 2012-2015	117
FORD RANGER 2019-	38	MITSUBISHI OUTLANDER 2015-2018	119
FORD TRANSIT 2006-2014	39	MITSUBISHI OUTLANDER 2018-	121
FORD TRANSIT 2014-	40	MITSUBISHI PAJERO 2007-2014	123
FORD TRANSIT CUSTOM 2012-2018	41	MITSUBISHI PAJERO 2014-	125
FORD TRANSIT CUSTOM 2018-	43	NISSAN JUKE 2010-2014	127
HONDA CRV 2006-2009	45	NISSAN NAVARA	
HONDA CRV 2012-2016	46	D40- (2005-2010) / D40N- (2010-2015)	128
HONDA CRV 2016-2018	48	NISSAN NAVARA NP300 2015-	130
HYUNDAI IX35 2010-2013-2015	49	NISSAN PATHFINDER	
HYUNDAI SANTA-FE 2012-2018	51	PATH- (2005-2010) / PATHN- (2010-)	133
HYUNDAI TUCSON 2015-2018	53	NISSAN QASHQAI 2007-2010	134
ISUZU D-MAX 2012-2017	55	NISSAN QASHQAI 2010-2013	136
ISUZU D-MAX 2017-	57	NISSAN QASHQAI 2013-2017	138
Isuzu D-MAX - AT35	60	NISSAN QASHQAI 2017-	140
JEEP GRAND CHEROKEE 2011-2014	62	NISSAN X-TRAIL	142
JEEP GRAND CHEROKEE 2015-	63	R-00 (2007-2010) / R-10 (2010-2014)	142
JEEP RENEGADE 2014-2018	64	NISSAN X-TRAIL 2014-2017	144
KIA SORENTO 2010-2012	66	OPEL CROSSLAND X 2017-	146
KIA SORENTO 2012-2015	68	OPEL VIVARO 2014-	147
KIA SORENTO 2015-2018	70	REANALT KADJAR 2016-	149
KIA SORENTO 2018-	72	REANALT MASTER 2010-	151
KIA SOUL 2008-2013	73	SSANGYONG MUSSO 2018-	152
KIA SPORTAGE 2008-2010	74	SSANGYONG REXTON 2018-	154

TABLE OF CONTENTS

SEAT ATECA 2016-	156
SKODA KODIAQ 2016-	158
SUBARU FORESTER 2008-2012	160
SUBARU FORESTER 2013-2016	162
SUBARU FORESTER 2016-	164
SUZUKI GRAND VITARA 2006-2015	166
SUZUKI JIMNY 2005-2012	168
SUZUKI JIMNY 2012-2018	170
SUZUKI JIMNY 2018-	172
SUZUKI SX4 2006-2013	174
SUZUKI SX4 S-CROSS 2013-2016	175
SUZUKI SX4 S-CROSS 2016-	177
SUZUKI VITARA 2015-2018	179
SUZUKI VITARA 2018-	181
TOYOTA HILUX 2005-2011-2015	183
Toyota Hilux - AT35	186
TOYOTA HILUX 2015-	188
TOYOTA HILUX 2018-	191
Toyota Hilux / Hilux Revo - AT35	194
TOYOTA LAND CRUISER 120 2003-2009	196
TOYOTA LAND CRUISER 150 2010-2013	198
TOYOTA LAND CRUISER 150 2013-2017	200
Toyota Land Cruiser 150 - AT35	202
TOYOTA LAND CRUISER 150 2017-	204
TOYOTA LAND CRUISER V8	
R00-(2007-2012) / R12-(2012-2016)	206
Toyota Land Cruiser V8 / LC200 - AT35	208
TOYOTA PROACE / PROACE VERSO 2016-	210
TOYOTA RAV4 2006-2010	211
TOYOTA RAV4 2010-2013	213
TOYOTA RAV4 2013-2015	215
TOYOTA RAV4 2015-2018	217
TOYOTA RAV4 2018-	219
VOLKSWAGEN AMAROK 2009-2016	221
VOLKSWAGEN AMAROK V6 2016-	223
VOLKSWAGEN CADDY 2010-2017	226
VOLKSWAGEN CRAFTER 2006-2017	227
VOLKSWAGEN CRAFTER 2017-	228
VOLKSWAGEN T5 2003-2010-2015	230
VOLKSWAGEN T6 2015-	232
VOLKSWAGEN TIGUAN 2007-2011-2015	234
VOLKSWAGEN TOUREG 2011-2015	236
VOLVO XC60 2014-2017	238
4x4 & pick-up accessories	240



„e”

NORMA
STANDARD
HOPMA
FRANCE

Dyrektywa 78/2009/EC określa wymagania jakie muszą spełniać bezpieczne rury montowane na samochodach poruszających się po drogach całej Europy - w tym też Polski. Jako jedyny polski producent potrafimy osiągnąć wystarczającą jakość by sprostać wymaganiom tej normy. Pamiętajmy, że w przypadku kolizji orurowanie zabezpiecza samochód i jednocześnie chroni pieszych przed urazami.

78/2009/EC directive specifies the demands that have to be met by pedestrian protection guard installed in cars in entire Europe, including Poland. As the exclusive Polish manufacturer, we can reach the sufficient quality to meet the demands posed by this standard. We need to remember that in case of collision the front guard system secures your car and protects pedestrians against injury.

Директива 78/2009/ЕС определяет требования, какие должны выполнять безопасные трубы на автомобилях, которые перемещаются по дорогам всей Европы - в том и Польши. Наша фирма является единственным польским производителем, осуществляющим требования этой директивы в области качества. Мы должны помнить, что современная установка навесного оборудования обеспечивает машину в такой же степени, как и пешеходов.

Die Richtlinie 78/2009/ EC bestimmt Anforderungen, die die auf Autos montierten sicheren Bügel innerhalb von EU erfüllen müssen. Wir sind der einzige Hersteller in Polen, der solche Qualität erreicht und diese Rechtsform bewältigen kann. Man soll immer in Erinnerung behalten, dass während einer Kollision die Bügel das Auto schützen und gleichzeitig die Fußgänger gegen Verletzungen sichern.

La directive 78/2009 / CE spécifie les exigences auxquelles doivent répondre les pare-buffles sécurisés montés sur les voitures circulant sur les routes à travers l'Europe - y compris la Pologne. En tant que seul fabricant polonais, nous pouvons atteindre une qualité suffisante pour répondre aux exigences de cette norme. Rappelez-vous qu'en cas de collision, le pare buffle protège la voiture et protège en même temps les piétons contre les blessures.

CHEVROLET CAPTIVA 2012-2015



POLISHED: CAPTIVA-R1170
BLACK: CAPTIVA-R1170-B



POLISHED: CAPTIVA-R1160-R
BLACK: CAPTIVA-R1160-R-B



POLISHED: CAPTIVA-R1176-PR-01
BLACK: CAPTIVA-R1176-PR-01-B



POLISHED: CAPTIVA-R1170-PR-02
BLACK: CAPTIVA-R1170-PR-02-B

CHEVROLET CAPTIVA

2012-2015



POLISHED: CAPTIVA-R1170-03
BLACK: CAPTIVA-R1170-03-B



POLISHED: CAPTIVA-R1170-04
BLACK: CAPTIVA-R1170-04-B



POLISHED: CAPTIVA-R1170-05
BLACK: CAPTIVA-R1170-05-B



POLISHED: CAPTIVA-R1170-06
BLACK: CAPTIVA-R1170-06-B



POLISHED: CAPTIVA-R1170-07
BLACK: CAPTIVA-R1170-07-B



POLISHED: CAPTIVA-R1170-08
BLACK: CAPTIVA-R1170-08-B

POLISHED: CAPTIVA-R1148-NR-02
BLACK: CAPTIVA-R1148-NR-02-B



CHEVROLET TRAX

2013-



POLISHED: TRAX-R1360-03
BLACK: TRAX-R1360-03-B



POLISHED: TRAX-R1360-04
BLACK: TRAX-R1360-04-B



POLISHED: TRAX-R1360-05
BLACK: TRAX-R1360-05-B



POLISHED: TRAX-R1360-08
BLACK: TRAX-R1360-08-B



POLISHED: TRAX-R1360-R
BLACK: TRAX-R1360-R-B



POLISHED: TRAX-R1376-PR-01
BLACK: TRAX-R1376-PR-01-B



POLISHED: TRAX-R1370-PR-02
BLACK: TRAX-R1370-PR-02-B

CITROEN JUMPER

2006-2014



POLISHED: JUMPER-R0070
BLACK: JUMPER-R0070-B



POLISHED: JUMPER-R0070-03
BLACK: JUMPER-R0070-03-B



POLISHED: JUMPER-R0070-06
BLACK: JUMPER-R0070-06-B



POLISHED: JUMPER-R0070-04
BLACK: JUMPER-R0070-04-B

CITROEN JUMPER

2014-2016



POLISHED: JUMPER-R0070
BLACK: JUMPER-R0070-B



POLISHED: JUMPER-R0070-03
BLACK: JUMPER-R0070-03-B



POLISHED: JUMPER-R0070-04
BLACK: JUMPER-R0070-04-B



POLISHED: JUMPER-R0070-06
BLACK: JUMPER-R0070-06-B

CITROEN BERLINGO VAN 2019-



POLISHED: BPC-R1960-00
BLACK: BPC-R1960-00-B

POLISHED: BPC-R1960-06
BLACK: BPC-R1960-06-B



POLISHED: BPC-R1960-03
BLACK: BPC-R1960-03-B



POLISHED: BPC-R1960-06
BLACK: BPC-R1960-06-B

DACIA DUSTER 2010-2014



POLISHED: DUSTER-R1060-00
BLACK: DUSTER-R1060-00-B



POLISHED: DUSTER-R1060-03
BLACK: DUSTER-R1060-03 -B



POLISHED: DUSTER-R1060-04
BLACK: DUSTER-R1060-04-B



POLISHED: DUSTER-R1076-03
BLACK: DUSTER-R1076-03-B



POLISHED: DUSTER-R1076-04
BLACK: DUSTER-R1076-04-B



POLISHED: DUSTER-R1048-NR
BLACK: DUSTER-R1048-NR-B



POLISHED: DUSTER-R1060-R
BLACK: DUSTER-R1060-R-B

DACIA DUSTER
2014-2018



POLISHED: DUSTER-R1060-04
BLACK: DUSTER-R1060-04-B



POLISHED: DUSTER-R1060-03
BLACK: DUSTER-R1060-03-B



POLISHED: DUSTER-R1060-00
BLACK: DUSTER-R1060-00-B

DACIA SANDERO STEPAWAY
2012-2016



POLISHED: STEPWAY-R1260-00
BLACK: STEPWAY-R1260-00-B

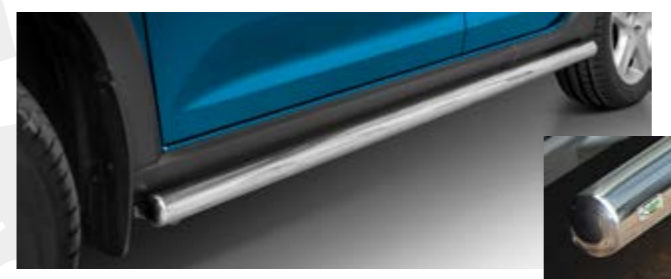

POLISHED: STEPWAY-R1260-R
BLACK: STEPWAY-R1260-R-B



POLISHED: STEPWAY-R1260-06
BLACK: STEPWAY-R1260-06-B



POLISHED: STEPWAY-R1260-03
BLACK: STEPWAY-R1260-03-B



POLISHED: STEPWAY-R1260-04
BLACK: STEPWAY-R1260-04-B

DACIA DUSTER 2018-



POLISHED: DUSTER-R1860-00
BLACK: DUSTER-R1860-00-B



POLISHED: DUSTER-R1848-NR
BLACK: DUSTER-R1848-NR-B



POLISHED: DUSTER-R1860-03
BLACK: DUSTER-R1860-03-B



POLISHED: DUSTER-R1860-06
BLACK: DUSTER-R1860-06-B



POLISHED: DUSTER-R1860-04
BLACK: DUSTER-R1860-04-B

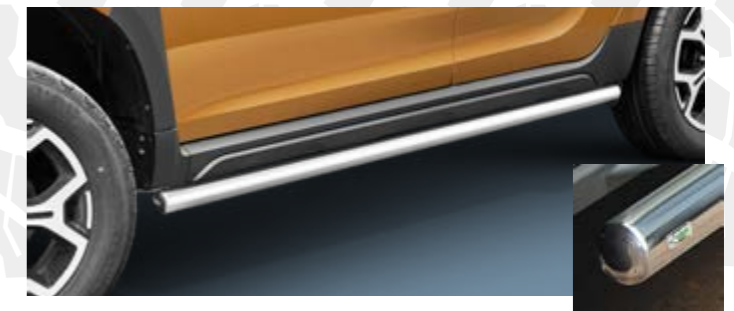

POLISHED: DUSTER-R1860-R
BLACK: DUSTER-R1860-R-B

FIAT DUCATO 2006-2014



POLISHED: DUCATO-R0070
BLACK: DUCATO-R0070-B



POLISHED: DUCATO-R0070-03
BLACK: DUCATO-R0070-03-B



POLISHED: DUCATO-R0070-04
BLACK: DUCATO-R0070-04-B



POLISHED: DUCATO-R0070-06
BLACK: DUCATO-R0070-06-B

FIAT DUCATO 2014-2016-



POLISHED: DUCATO-R0070
BLACK: DUCATO-R0070-B



POLISHED: DUCATO-R0070-03
BLACK: DUCATO-R0070-03-B



POLISHED: DUCATO-R0070-04
BLACK: DUCATO-R0070-04-B



POLISHED: DUCATO-R0070-06
BLACK: DUCATO-R0070-06-B

FIAT FULLBACK 2015-



POLISHED: FULLBACK-R1570-03



POLISHED: FULLBACK-R1570-06



POLISHED: FULLBACK-R1570-04



POLISHED: FULLBACK-L1570-05



POLISHED: FULLBACK-R1570-00



POLISHED: FULLBACK-L1570-07

POLISHED: FULLBACK-L1570-08



POLISHED: FULLBACK-R1770-PR



POLISHED: FULLBACK-R1776-PR-01



BLACK: FULLBACK-R1770-PR-B



BLACK: FULLBACK-R1776-PR-01-B



POLISHED: FULLBACK-R1770-PR-02



POLISHED: FULLBACK-R17100-PR-01



BLACK: FULLBACK-R1770-PR-02-B



BLACK: FULLBACK-R17100-PR-01-B

FIAT FULLBACK 2015-



BLACK: FULLBACK-R1570-03-B



BLACK: FULLBACK-R1570-04-B



BLACK: FULLBACK-R1570-00-B



POLISHED: FULLBACK-R1770-GR



BLACK: FULLBACK-R1770-GR



BLACK: FULLBACK-R1570-06-B



BLACK: FULLBACK-L1570-05-B



BLACK: FULLBACK-L1570-07-B



BLACK: FULLBACK-L1570-08-B



POLISHED: FULLBACK-R1776-GR



BLACK: FULLBACK-R1776-GR

FORD CONNECT 2013-2018-



POLISHED: CONNECT-R1360-00
BLACK: CONNECT-R1360-00-B



POLISHED: CONNECT-R1360-03
BLACK: CONNECT-R1360-03-B



POLISHED: CONNECT-R1360-04
BLACK: CONNECT-R1360-03-B



POLISHED: CONNECT-R1360-06
BLACK: CONNECT-R1360-06-B



POLISHED: CONNECT-R1348-R-LWB
BLACK: CONNECT-R1348-R-LWB-B



POLISHED: CONNECT-R1348-R-LWB
BLACK: ONNECT-R1348-R-LWB-B



POLISHED: CONNECT-R1348-R-LWB
BLACK: CONNECT-R1348-R-LWB-B

FORD COURIER
2014-2018



POLISHED: COURIER-R1460
BLACK: COURIER-R1460-B

POLISHED: COURIER-R1460-03
BLACK: COURIER-R1460-03-B



POLISHED: COURIER-R1448-R
BLACK: COURIER-R1448-R-B



POLISHED: COURIER-R1460-04
BLACK: COURIER-R1460-04-B

FORD COURIER
2018-



POLISHED: COURIER-R1860-04
BLACK: COURIER-R1860-04-B



POLISHED: COURIER-R1860-03
BLACK: COURIER-R1860-03-B



POLISHED: COURIER-R1860-06
BLACK: COURIER-R1860-06-B



POLISHED: COURIER-R1848-R
BLACK: COURIER-R1848-R-B



POLISHED: COURIER-R1860-00
BLACK: COURIER-R1860-00-B

FORD KUGA

2008-2013



POLISHED: K-R0060-03
BLACK: K-R0060-03-B



POLISHED: K-R0060-04
BLACK: K-R0060-04



POLISHED: K-R0076-05
BLACK: K-R0076-05-B



POLISHED: K-R0076-06
BLACK: K-R0076-06-B

POLISHED: K-R0060
BLACK: K-R0060-B



POLISHED: K-R0070-R
BLACK: K-R0070-R-B



POLISHED: K-R0070-PR-01
BLACK: K-R0070-PR-01-B



POLISHED: K-R0070-PR-02
BLACK: K-R0070-PR-02-B

POLISHED: K-R0070-NR
BLACK: K-R0070-NR-B



FORD KUGA 2012-2017



POLISHED: K-R1360-04
BLACK: K-R1360-04-B



POLISHED: K-R1360-R
BLACK: K-R1360-R-B



POLISHED: K-R1360-PR
BLACK: K-R1360-PR-B



POLISHED: K-R1376-PR-01
BLACK: K-R1376-PR-01-B



POLISHED: K-R1370-PR-02
BLACK: K-R1370-PR-02-B



POLISHED: K-R1360-03
BLACK: K-R1360-03-B



POLISHED: K-R1360
BLACK: K-R1360-B



POLISHED: K-R1360-06
BLACK: K-R1360-06-B



POLISHED: K-R1370
BLACK: K-R1370-B



POLISHED: K-R1370-03
BLACK: K-R1370-03-B



POLISHED: K-R1370-04
BLACK: K-R1370-04-B



POLISHED: K-R1370-NR
BLACK: K-R1370-NR-B

FORD KUGA 2017-



POLISHED: K-L1770-08
BLACK: K-L1770-08-B



POLISHED: K-R1760-03
BLACK: K-R1760-03-B



POLISHED: K-R1760-06
BLACK: K-R1760-06-B



POLISHED: K-R1760-00
BLACK: K-R1760-00-B



POLISHED: K-R1760-04
BLACK: K-R1760-04-B



POLISHED: K-L1770-05
BLACK: K-L1770-05-B



POLISHED: K-L1770-07
BLACK: K-L1770-07-B



POLISHED: K-R1760-R
BLACK: K-R1760-R-B



POLISHED: K-R1770-PR
BLACK: K-R1770-PR-B



POLISHED: K-R1770-PR-02
BLACK: K-R1770-PR-02-B



POLISHED: K-R1776-PR-01
BLACK: K-R1776-PR-01-B

FORD RANGER

2007-2012



POLISHED: RANGER-R0085-00
BLACK: RANGER-R0085-00-B



POLISHED: RANGER-R0076-04
BLACK: RANGER-R0076-04-B



POLISHED: RANGER-R0076-06
BLACK: RANGER-R0076-06-B



POLISHED: RANGER-R0085-03
BLACK: RANGER-R0085-03-B



POLISHED: RANGER-R0085-04
BLACK: RANGER-R0085-04-B



POLISHED: RANGER-R0085-06
BLACK: RANGER-R0085-06-B



POLISHED: RANGER-R0085-PR
BLACK: RANGER-R0085-PR-B



POLISHED: RANGER-R0085-PR-01
BLACK: RANGER-R0085-PR-01-B



POLISHED: RANGER-R0085-PR-02
BLACK: RANGER-R0085-PR-02-B



POLISHED: RANGER-R0076-GR
BLACK: RANGER-R0076-GR-B

FORD RANGER

2012-2016



POLISHED: R12-R1285-00
BLACK: R12-R1285-00-B



POLISHED: R12-R1276-03
BLACK: R12-R1276-03-B



POLISHED: R12-R1276-04
BLACK: R12-R1276-04-B



POLISHED: R12-R1276-06
BLACK: R12-R1276-06-B



POLISHED: R12-R1285-03
BLACK: R12-R1285-03-B



POLISHED: R12-R1285-04
BLACK: R12-R1285-04-B



POLISHED: R12-R1285-06
BLACK: R12-R1285-06-B



POLISHED: R12-R1285-PR
BLACK: R12-R1285-PR-B



POLISHED: R12-R1285-PR-01
BLACK: R12-R1285-PR-01-B



POLISHED: R12-R1285-PR-02
BLACK: R12-R1285-PR-02-B



POLISHED: R12-R1276-GR
BLACK: R12-R1276-GR-B

FORD RANGER

2016-2019



POLISHED: R12-R1285-04
BLACK: R12-R1285-04-B



POLISHED: R16-L1670-05
BLACK: R16-L1670-05-B



POLISHED: R16-L1670-08
BLACK: R16-L1670-08-B



POLISHED: R16-L1670-07
BLACK: R16-L1670-07-B



POLISHED: R12-R1285-03
BLACK: R12-R1285-03-B



POLISHED: R12-R1285-00
BLACK: R12-R1285-00-B



POLISHED: R12-R1285-06V2
BLACK: R12-R1285-06V2-B



POLISHED: R12-R1285-PR
BLACK: R12-R1285-PR-B



POLISHED: R12-R1285-PR-01
BLACK: R12-R1285-PR-01-B



POLISHED: R12-R1285-PR-02
BLACK: R12-R1285-PR-02-B



POLISHED: R12-R1276-GR
BLACK: R12-R1276-GR-B

FORD RANGER 2019-



POLISHED: R19-R1970-00



POLISHED: R19-R1970-03



POLISHED: R19-R1970-06



POLISHED: R19-R1970-04



POLISHED: R16-L1670-05



POLISHED: R16-L1670-08



POLISHED: R16-L1670-07



POLISHED: R19-R1970-S



POLISHED: R12-R1285-PR-01



POLISHED: R12-R1285-PR-02



BLACK: R12-R1285-PR-01-B



BLACK: R12-R1285-PR-02-B



POLISHED: R12-R1285-PR



BLACK: R12-R1285-PR-B

FORD RANGER 2019-



BLACK: R19-R1970-03-B



BLACK: R19-R1970-00-B



BLACK: R16-L1670-05-B



BLACK: R16-L1670-07-B



POLISHED: R12-R1276-GR



BLACK: R19-R1970-06-B



BLACK: R19-R1970-04-B



BLACK: R16-L1670-08-B



BLACK: R19-R1970-S-B



BLACK: R12-R1276-GR-B

FORD TRANSIT 2006-2014



POLISHED: TRANSIT-R0070-04
BLACK: TRANSIT-R0070-04-B



POLISHED: TRANSIT-R0070
BLACK: TRANSIT-R0070-B



POLISHED: TRANSIT-R0070-03
BLACK: TRANSIT-R0070-03-B



POLISHED: TRANSIT-R0070-06
BLACK: TRANSIT-R0070-06-B



POLISHED: TRANSIT-R0070-R
BLACK: TRANSIT-R0070-R-B



POLISHED: TRANSIT-R0076-PR-01
BLACK: TRANSIT-R0076-PR-01-B



POLISHED: TRANSIT-R0070-PR-02
BLACK: TRANSIT-R0070-PR-02-B

FORD TRANSIT

2014-



POLISHED: TRANSIT-R1370-04
BLACK: TRANSIT-R1370-04-B



POLISHED: TRANSIT-R1370-00
BLACK: TRANSIT-R1370-00-B



POLISHED: TRANSIT-R1370-03
BLACK: TRANSIT-R1370-03-B



POLISHED: TRANSIT-R1370-06
BLACK: TRANSIT-R1370-06-B



POLISHED: TRANSIT-R1370-R-L3
BLACK: TRANSIT-R1370-R-L3-B



POLISHED: TRANSIT-R1376-PR-01-L3
BLACK: TRANSIT-R1376-PR-01-L3-B



POLISHED: TRANSIT-R1370-PR-02-L3
BLACK: TRANSIT-R1370-PR-02-L3-B

FORD TRANSIT CUSTOM

2012-2018



POLISHED: CUSTOM-R1276-04
BLACK: CUSTOM-R1276-04-B



POLISHED: CUSTOM-R1270-PR-02-L2
BLACK: CUSTOM-R1270-PR-02-L2-B



POLISHED: CUSTOM-R1270-R-L2
BLACK: CUSTOM-R1270-R-L2-B



POLISHED: CUSTOM-R1276-PR-01-L2
BLACK: CUSTOM-R1276-PR-01-L2-B

FORD TRANSIT CUSTOM 2012-2018



POLISHED: CUSTOM-R1270
BLACK: CUSTOM-R1270-B



POLISHED: CUSTOM-R1270-03
BLACK: CUSTOM-R1270-03-B



POLISHED: CUSTOM-R1270-04
BLACK: CUSTOM-R1270-04-B



POLISHED: CUSTOM-R1270-06
BLACK: CUSTOM-R1270-06-B



POLISHED: CUSTOM-R1276-03
BLACK: CUSTOM-R1276-03-B



POLISHED: CUSTOM-R1276-06
BLACK: CUSTOM-R1276-06-B

FORD TRANSIT CUSTOM 2018-



POLISHED: CUSTOM-L1870-08
BLACK: CUSTOM-L1870-08-B



POLISHED: CUSTOM-R1870-PR-02
BLACK: CUSTOM-R1870-PR-02-B



POLISHED: CUSTOM-R1860-R
BLACK: CUSTOM-R1860-R-B



POLISHED: CUSTOM-R1876-PR-01
BLACK: CUSTOM-R1876-PR-01-B

FORD TRANSIT CUSTOM 2018-

HONDA CRV 2006-2009



POLISHED: CUSTOM-R1870-00
BLACK: CUSTOM-R1870-00-B



POLISHED: CUSTOM-R1870-03
BLACK: CUSTOM-R1870-03-B



POLISHED: CUSTOM-R1870-04
BLACK: CUSTOM-R1870-04-B



POLISHED: CUSTOM-R1870-06
BLACK: CUSTOM-R1870-06-B



POLISHED: CUSTOM-L1870-05
BLACK: CUSTOM-L1870-05-B



POLISHED: CUSTOM-L1870-07
BLACK: CUSTOM-L1870-07-B



POLISHED: CRV-R0070-06
BLACK: CRV-R0070-06-B

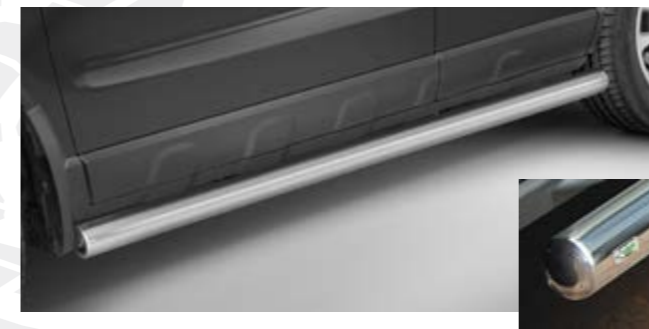

POLISHED: CRV-R0060-R
BLACK: CRV-R0060-R-B



POLISHED: CRV-R0060-PR
BLACK: CRV-R0060-PR-B



POLISHED: CRV-R0076-PR-01
BLACK: CRV-R0076-PR-01-B



POLISHED: CRV-R0070-PR-02
BLACK: CRV-R0070-PR-02-B

HONDA CRV

2012-2016



POLISHED: CRV-R1260
BLACK: CRV-R1260-B



POLISHED: CRV-R1260-03
BLACK: CRV-R1260-03-B



POLISHED: CRV-R1260-04
BLACK: CRV-R1260-04-B



POLISHED: CRV-R1260-06
BLACK: CRV-R1260-06-B



POLISHED: CRV-R1270-03 (2012-2015)
BLACK: CRV-R1270-03-B (2012-2015)



POLISHED: CRV-R1270-04 (2012-2015)
BLACK: CRV-R1270-04-B (2012-2015)



POLISHED: CRV-R1270-05 (2012-2015)
BLACK: CRV-R1270-05-B (2012-2015)

POLISHED: CRV-R1248-NR
BLACK: CRV-R1248-NR-B



POLISHED: CRV-R1260-R
BLACK: CRV-R1260-R-B



POLISHED: CRV-R1270-PR
BLACK: CRV-R1270-PR-B



POLISHED: CRV-R1276-PR-01
BLACK: CRV-R1276-PR-01-B



POLISHED: CRV-R1270-PR-02
BLACK: CRV-R1270-PR-02-B

HONDA CRV

2016-2018

POLISHED: CRV-R1260-04
BLACK: CRV-R1260-04-B



POLISHED: CRV-R1260-03
BLACK: CRV-R1260-03-B



POLISHED: CRV-R1260-06
BLACK: CRV-R1260-06-B



POLISHED: CRV-R1260-R
BLACK: CRV-R1260-R-B



POLISHED: CRV-R1276-PR-01
BLACK: CRV-R1276-PR-01-B



POLISHED: CRV-R1270-PR-02-B
BLACK: CRV-R1270-PR-02

HYUNDAI IX35

2010-2013-2015



POLISHED: IX35-R1076-04
BLACK: IX35-R1076-04-B



POLISHED: IX35-R1060-R
BLACK: IX35-R1060-R-B



POLISHED: IX35-R1076-PR-01
BLACK: IX35-R1076-PR-01-B

HYUNDAI IX35
2010-2013-2015



POLISHED: IX35-R1070
BLACK: IX35-R1070-B



POLISHED: IX35-R1070-03
BLACK: IX35-R1070-03-B



POLISHED: IX35-R1070-04
BLACK: IX35-R1070-04-B



POLISHED: IX35-R1070-06
BLACK: IX35-R1070-06-B



POLISHED: IX35-R1076-03
BLACK: IX35-R1076-03-B



POLISHED: IX35-R1070-PR-02
BLACK: IX35-R1070-PR-02-B



POLISHED: IX35-R1070-NR
BLACK: IX35-R1070-NR-B

HYUNDAI SANTA-FE
2012-2018



POLISHED: SANTA-FE-R1270
BLACK: SANTA-FE-R1270-B



POLISHED: SANTA-FE-R1260-R
BLACK: SANTA-FE-R1260-R-B



POLISHED: SANTA-FE-R1270-PR
BLACK: SANTA-FE-R1270-PR-B



POLISHED: SANTA-FE-R1276-PR-01
BLACK: SANTA-FE-R1276-PR-01-B



POLISHED: SANTA-FE-R1270-PR-02
BLACK: SANTA-FE-R1270-PR-02-B

HYUNDAI SANTA-FE

2012-2018



POLISHED: SANTA-FE-R1270-03
BLACK: SANTA-FE-R1270-03-B



POLISHED: SANTA-FE-R1270-04
BLACK: SANTA-FE-R1270-04-B



POLISHED: SANTA-FE-R1270-06
BLACK: SANTA-FE-R1270-06-B



POLISHED: SANTA-FE-R1276-00
BLACK: SANTA-FE-R1276-00-B



POLISHED: SANTA-FE-R1276-03
BLACK: SANTA-FE-R1276-03-B



POLISHED: SANTA-FE-R1276-04
BLACK: SANTA-FE-R1276-04-B

POLISHED: SANTA-FE-R1270-NR
BLACK: SANTA-FE-R1270-NR-B



HYUNDAI TUCSON

2015-2018



POLISHED: TUCSON-R1570-00
BLACK: TUCSON-R1570-00-B



POLISHED: TUCSON-R1560-R
BLACK: TUCSON-R1560-R-B



POLISHED: TUCSON-R1576-PR-01
BLACK: TUCSON-R1576-PR-01-B

HYUNDAI TUCSON

2015-2018



POLISHED: TUCSON-R1570-06
BLACK: TUCSON-R1570-06-B



POLISHED: TUCSON-R1570-03
BLACK: TUCSON-R1570-03-B



POLISHED: TUCSON-R1570-04
BLACK: TUCSON-R1570-04-B



POLISHED: TUCSON-L1560-05
BLACK: TUCSON-L1560-05-B



POLISHED: TUCSON-L1560-08
BLACK: TUCSON-L1560-08-B



POLISHED: TUCSON-R1570-PR-02
BLACK: TUCSON-R1570-PR-02-B

ISUZU D-MAX

2012-2017



POLISHED: D-MAX-R1270-00
BLACK: D-MAX-R1270-00-B

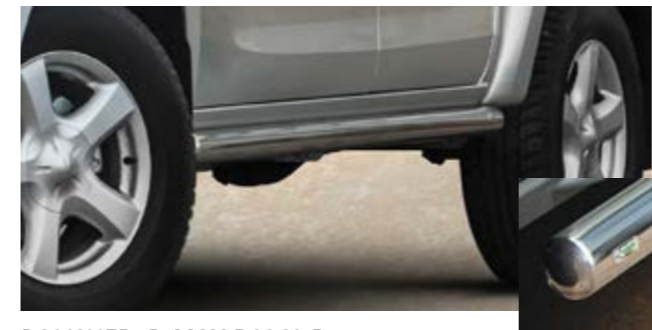

POLISHED: D-MAX-R1260-R
BLACK: D-MAX-R1260-R-B



POLISHED: D-MAX-R1270-PR
BLACK: D-MAX-R1270-PR-B



POLISHED: D-MAX-R1276-PR-01
BLACK: D-MAX-R1276-PR-01-B



POLISHED: D-MAX-R1270-PR-02
BLACK: D-MAX-R1270-PR-02-B

ISUZU D-MAX

2012-2017



POLISHED: D-MAX-R1270-03
BLACK: D-MAX-R1270-03-B



POLISHED: D-MAX-R1270-04
BLACK: D-MAX-R1270-04-B



POLISHED: D-MAX-R1270-06
BLACK: D-MAX-R1270-06-B



POLISHED: D-MAX-R1276
BLACK: D-MAX-R1276-B



POLISHED: D-MAX-R1276-03
BLACK: D-MAX-R1276-03-B



POLISHED: D-MAX-R1276-04
BLACK: D-MAX-R1276-04-B



POLISHED: D-MAX-R1276-GR
BLACK: D-MAX-R1276-GR-B

ISUZU D-MAX

2017-



POLISHED: D-MAX-R1270-04
BLACK: D-MAX-R1270-04-B



POLISHED: D-MAX-R1260-R



POLISHED: D-MAX-R1270-PR



POLISHED: D-MAX-R1276-PR-01-B



POLISHED: D-MAX-R1270-PR-02

ISUZU D-MAX 2017-



POLISHED: D-MAX-R1270-03



POLISHED: D-MAX-R1270-06



BLACK: D-MAX-R1270-03-B



BLACK: D-MAX-R1270-06-B



POLISHED: D-MAX-R1270-00



POLISHED: D-MAX-R1276-03



BLACK: D-MAX-R1270-00-B



BLACK: D-MAX-R1270-00-B



POLISHED: D-MAX-R1276-04



POLISHED: D-MAX-R1276



BLACK: D-MAX-R1276-04-B



BLACK: D-MAX-R1276-03-B



BLACK: D-MAX-R1260-R-B



BLACK: D-MAX-R1270-PR-B



BLACK: D-MAX-R1276-PR-01-B



BLACK: D-MAX-R1270-PR-02-B



BLACK: D-MAX-R1276-B



POLISHED: D-MAX-R1276



BLACK: D-MAX-R1276-B

Isuzu D-MAX - AT35



AFTER CONVERSION

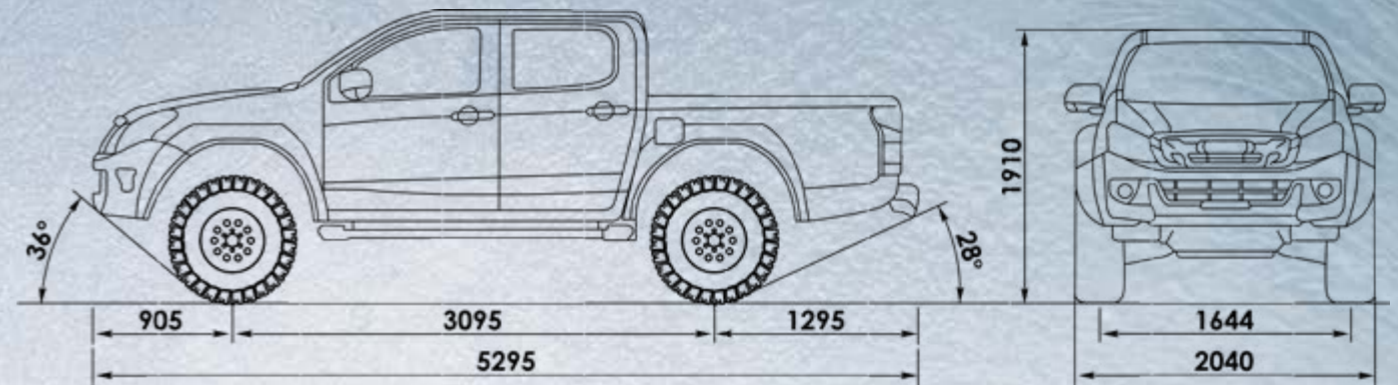

Choose your suspension

Choose your tyres



Old Man Emu suspension



OME BP-51 suspension



BF Goodrich A/T KO2 315/70 R17

Nokian Hakkapelita LT 2 315/70 R17

When we convert D-MAX to 35" tires, we lift the suspension 30 mm and the body - 20mm. Extra fender flares are used which gives your PICK-UP a powerful look and separates it from all others. With the AT35 you can take your PICK-UP to almost any mountain road in the world, without having any trouble.

The AT35 will give you much grater ground clearance, better traction, softer ride, higher seating and most of all a feeling of confidence. Also will it give you the possibility to deflate your tires, so that you get a better flotation in snow, sand and mud.

The AT35 is ideal for hunters, farmers and park rangers, or just for those who want something different from the rest.

- 315x70 R17" tires BFG AT KO2 or Nokian Hakkapeliitta LT2 „Arctic Trucks”
- 17x10" alloy wheels
- Torque wrench
- Fender flares, painted
- Running boards and brackets
- Mud flaps
- Speedometer calibrator
- 30 mm OME suspension lift, front/rear
- 20 mm body lift
- Fender trimming, front/rear
- First aid kit
- Wheel alignment

Modification cost with OME suspension: 9 200 euro net
Delivery to our location not included.
Stainless steel products and additional lamps are not included.
Lead time: 15 working days.
Payment: 10% with the order 90% before car pick up.

Contact:
e-mail: info@arctictrucks.pl
phone: +48 85 711 95 58

JEEP GRAND CHEROKEE

2011-2014



POLISHED: GCH-L1060-05
BLACK: GCH-L1060-05-B



POLISHED: GCH-R1070-06
BLACK: GCH-R1070-06 -B



POLISHED: GCH-R1060-R
BLACK: GCH-R1060-R-B



POLISHED: GCH-R1070-PR-02
BLACK: GCH-R1070-PR-02-B



POLISHED: GCH-R1076-PR-01
BLACK: GCH-R1076-PR-01 -B

JEEP GRAND CHEROKEE

2015-



POLISHED: GCH-R1570-06
BLACK: GCH-R1570-06-B



POLISHED: GCH-L1570-05-B
BLACK: GCH-L1570-05



POLISHED: GCH-R1560-R-B
BLACK: GCH-R1560-R



POLISHED: GCH-R1570-PR-02-B
BLACK: GCH-R1570-PR-02



POLISHED: GCH-R1576-PR-01
BLACK: GCH-R1576-PR-01-B

JEEP RENEGADE

2014-2018



POLISHED: RENEGADE-R1460-00
BLACK: RENEGADE-R1460-00-B



POLISHED: RENEGADE-R1460-03
BLACK: RENEGADE-R1460-03-B



POLISHED: RENEGADE-R1460-04
BLACK: RENEGADE-R1460-04-B



POLISHED: RENEGADE-L1460-09
BLACK: RENEGADE-L1460-09-B



POLISHED: RENEGADE-L1460-10
BLACK: RENEGADE-L1460-10-B



POLISHED: RENEGADE-R1460-R
BLACK: RENEGADE-R1460-R-B



POLISHED: RENEGADE-R1470-PR-02
BLACK: RENEGADE-R1470-PR-02-B



POLISHED: RENEGADE-R1476-PR-01
BLACK: RENEGADE-R1476-PR-01-B

KIA SORENTO

2010-2012



POLISHED: SOR-R0070-04
BLACK: SOR-R0070-04-B



POLISHED: SOR-R0070
BLACK: SOR-R0070-B



POLISHED: SOR-R0070-03
BLACK: SOR-R0070-03-B



POLISHED: SOR-R0070-06
BLACK: SOR-R0070-06-B



POLISHED: SOR-R0076-03
BLACK: SOR-R0076-03-B



POLISHED: SOR-R0076-04
BLACK: SOR-R0076-04-B



POLISHED: SOR-R0060-R
BLACK: SOR-R0060-R-B



POLISHED: SOR-R0070-PR
BLACK: SOR-R0070-PR-B



POLISHED: SOR-R0076-PR-01
BLACK: SOR-R0076-PR-01-B



POLISHED: SOR-R0070-PR-02
BLACK: SOR-R0070-PR-02-B

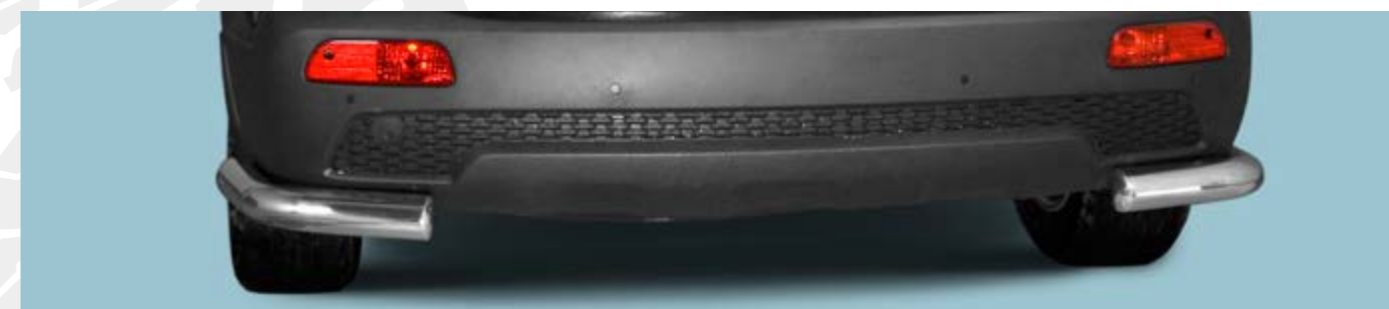

POLISHED: SOR-R0070-NR
BLACK: SOR-R0070-NR-B

KIA SORENTO

2012-2015



POLISHED: SOR-R1276-06
BLACK: SOR-R1276-06-B



POLISHED: SOR-R1260-R
BLACK: SOR-R1260-R-B



POLISHED: SOR-R1270-PR
BLACK: SOR-R1270-PR-B



POLISHED: SOR-R1276-PR-01
BLACK: SOR-R1276-PR-01-B



POLISHED: SOR-R1270-PR-02
BLACK: SOR-R1270-PR-02-B



POLISHED: SOR-R1270
BLACK: SOR-R1270-B



POLISHED: SOR-R1270-03
BLACK: SOR-R1270-03-B



POLISHED: SOR-R1270-04
BLACK: SOR-R1270-04-B



POLISHED: SOR-R1270-06
BLACK: SOR-R1270-06-B



POLISHED: SOR-R1276-03
BLACK: SOR-R1276-03-B



POLISHED: SOR-R1276-04
BLACK: SOR-R1276-04-B

POLISHED: SOR-R1270-NR
BLACK: SOR-R1270-NR-B



KIA SORENTO 2015-2018



POLISHED: SOR-R1570-04
BLACK: SOR-R1570-04-B



POLISHED: SOR-R1560-R
BLACK: SOR-R1560-R-B



POLISHED: SOR-R1570-PR
BLACK: SOR-R1570-PR-B



POLISHED: SOR-R1576-PR-01
BLACK: SOR-R1576-PR-01-B



POLISHED: SOR-R1570-PR-02
BLACK: SOR-R1570-PR-02-B



POLISHED: SOR-R1570
BLACK: SOR-R1570-B



POLISHED: SOR-R1570-03
BLACK: SOR-R1570-03-B



POLISHED: SOR-R1570-06
BLACK: SOR-R1570-06-B



POLISHED: SOR-L1570-05
BLACK: SOR-L1570-05-B



POLISHED: SOR-L1570-08
BLACK: SOR-L1570-08-B



POLISHED: SOR-L1570-07
BLACK: SOR-L1570-07-B

POLISHED: SOR-R1570-NR
BLACK: SOR-R1570-NR-B



KIA SORENTO
2018-



POLISHED: SOR-L1860-05
BLACK: SOR-L1860-05-B



POLISHED: SOR-R1560-R
BLACK: SOR-R1560-R-B



POLISHED: SOR-R1576-PR-01
BLACK: SOR-R1576-PR-01-B



POLISHED: SOR-R1570-PR
BLACK: SOR-R1570-PR-B



POLISHED: SOR-R1570-PR-02
BLACK: SOR-R1570-PR-02-B

KIA SOUL
2008-2013



POLISHED: SOUL-R0060-04
BLACK: SOUL-R0060-04-B



POLISHED: SOUL-R0060-03
BLACK: SOUL-R0060-03-B



POLISHED: SOUL-R0060-R
BLACK: SOUL-R0060-R-B



POLISHED: SOUL-R0060-05
BLACK: SOUL-R0060-05-B

KIA SPORTAGE
2008-2010



POLISHED: SPOR-R0070
BLACK: SPOR-R0070-B



POLISHED: SPOR-R0070-03
BLACK: SPOR-R0070-03-B



POLISHED: SPOR-R0070-04
BLACK: SPOR-R0070-04-B



POLISHED: SPOR-R0070-06
BLACK: SPOR-R0070-06-B



POLISHED: SPOR-R0076-03
BLACK: SPOR-R0076-03-B



POLISHED: SPOR-R0076-04
BLACK: SPOR-R0076-04-B



POLISHED: SPOR-R0060-R
BLACK: SPOR-R0060-R-B



POLISHED: SPOR-R0070-PR
BLACK: SPOR-R0070-PR-B



POLISHED: SPOR-R0076-PR-01
BLACK: SPOR-R0076-PR-01-B



POLISHED: SPOR-R0070-PR-02
BLACK: SPOR-R0070-PR-02-B



POLISHED: SPOR-R0070-NR
BLACK: SPOR-R0070-NR-B

KIA SPORTAGE
2010-2015



POLISHED: SPOR-R1070-00
BLACK: SPOR-R1070-00-B



POLISHED: SPOR-R0070-03
BLACK: SPOR-R0070-03-B



POLISHED: SPOR-R1070-04
BLACK: SPOR-R1070-04-B



POLISHED: SPOR-R1070-06
BLACK: SPOR-R1070-06-B



POLISHED: SPOR-R1076-03
BLACK: SPOR-R1076-03-B



POLISHED: SPOR-R1076-04
BLACK: SPOR-R1076-04-B



POLISHED: SPOR-R1060-R
BLACK: SPOR-R1060-R-B



POLISHED: SPOR-R1070-PR
BLACK: SPOR-R1070-PR-B



POLISHED: SPOR-R1076-PR-01
BLACK: SPOR-R1076-PR-01-B



POLISHED: SPOR-R1070-PR-02
BLACK: SPOR-R1070-PR-02-B



POLISHED: SPOR-R1070-NR
BLACK: SPOR-R1070-NR-B

KIA SPORTAGE
2015-2018



POLISHED: SPOR-R1570-00
BLACK: SPOR-R1570-00-B



POLISHED: SPOR-R1570-04
BLACK: SPOR-R1570-04-B



POLISHED: SPOR-R1570-03
BLACK: SPOR-R1570-03-B



POLISHED: SPOR-R1570-06
BLACK: SPOR-R1570-06-B



POLISHED: SPOR-L1570-05
BLACK: SPOR-L1570-05-B



POLISHED: SPOR-L1570-08
BLACK: SPOR-L1570-08-B



POLISHED: SPOR-R1570-R
BLACK: SPOR-R1570-R-B



POLISHED: SPOR-R1570-PR-02
BLACK: SPOR-R1570-PR-02-B



POLISHED: SPOR-R1580-PR-04
BLACK: SPOR-R1580-PR-04-B

KIA SPORTAGE 2018-



POLISHED: SPOR-R1870-04
BLACK: SPOR-R1870-04-B



POLISHED: SPOR-R1870-03
BLACK: SPOR-R1870-03-B



POLISHED: SPOR-R1870-06
BLACK: SPOR-R1870-06-B



POLISHED: SPOR-R1870-00
BLACK: SPOR-R1870-00-B



POLISHED: SPOR-L1570-05
BLACK: SPOR-L1570-05-B



POLISHED: SPOR-L1570-08
BLACK: SPOR-L1570-08-B



POLISHED: SPOR-R1570-R
BLACK: SPOR-R1570-R-B



POLISHED: SPOR-R1570-PR-02
BLACK: SPOR-R1570-PR-02-B



POLISHED: SPOR-R1580-PR-04
BLACK: SPOR-R1580-PR-04-B

LAND ROVER FREELANDER II

2007-2014



POLISHED: FREE2-R0070-06
BLACK: FREE2-R0070-06-B



POLISHED: FREE2-R0070-S
BLACK: FREE2-R0070-S-B



POLISHED: FREE2-R0070-03
BLACK: FREE2-R0070-03-B



POLISHED: FREE2-R0070-04
BLACK: FREE2-R0070-04 -B



POLISHED: FREE2-R0070-00
BLACK: FREE2-R0070-00-B



POLISHED: FREE2-R0060-R
BLACK: FREE2-R0060-R-B



POLISHED: FREE2-R0070-PR-02
BLACK: FREE2-R0070-PR-02-B



POLISHED: FREE2-R0076-PR-01
BLACK: FREE2-R0076-PR-01-B

LAND ROVER DISCOVERY V

2017-



POLISHED: DIS5-R1770-00
BLACK: DIS5-R1770-00-B



POLISHED: DIS5-R1770-03
BLACK: DIS5-R1770-03-B



POLISHED: DIS5-R1770-06
BLACK: DIS5-R1770-06-B



POLISHED: DIS5-R1770-04
BLACK: DIS5-R1770-04-B



POLISHED: DIS5-L1770-05
BLACK: DIS5-L1770-05-B



POLISHED: DIS5-L1770-08
BLACK: DIS5-L1770-08-B



POLISHED: DIS5-R1748-R
BLACK: DIS5-R1748-R-B



POLISHED: DIS5-R1770-PR-02
BLACK: DIS5-R1770-PR-02-B



POLISHED: DIS5-R1776-PR-01
BLACK: DIS5-R1776-PR-01-B



POLISHED: DIS5-R1760-PR
BLACK: DIS5-R1760-PR-B

LEXUS NX F-SPORT

2014-



POLISHED: NX-R1470-04
BLACK: NX-R1470-04-B



POLISHED: NX-R1470-06
BLACK: NX-R1470-06-B



POLISHED: NX-R1470-03
BLACK: NX-R1470-03-B



POLISHED: NX-R1460-08
BLACK: NX-R1460-08-B



POLISHED: NX-R1460-R
BLACK: NX-R1460-R-B



POLISHED: NX-R1470-PR-02
BLACK: NX-R1470-PR-02-B

MERCEDES SPRINTER

2006-2013-2018



POLISHED: SPRINTER-R0070-04
BLACK: SPRINTER-R0070-04-B



POLISHED: SPRINTER-R0070
BLACK: SPRINTER-R0070-B



POLISHED: SPRINTER-R0070-03
BLACK: SPRINTER-R0070-03-B

MERCEDES SPRINTER
2018-



POLISHED: SPRINTER-R1870-03
BLACK: SPRINTER-R1870-03-B



POLISHED: SPRINTER-R1870-06
BLACK: SPRINTER-R1870-06-B



POLISHED: SPRINTER-R1870-PR-02-L2
BLACK: SPRINTER-R1870-PR-02-L2-B



POLISHED: SPRINTER-R1860-R-L2
BLACK: SPRINTER-R1860-R-L2-B



POLISHED: SPRINTER-R1876-PR-01-L2
BLACK: SPRINTER-R1876-PR-01-L2-B

MERCEDES V-CLASS
2014-



POLISHED: V-CLASS-R1470-00
BLACK: V-CLASS-R1470-00-B



POLISHED: V-R1460-R-SWB / V-R1460-R-LWB
BLACK: V-R1460-R-SWB-B / V-R1460-R-LWB-B



POLISHED: V-R1470-PR-02-SWB / V-R1470-PR-02-LWB
BLACK: V-R1470-PR-02-SWB-B / V-R1470-PR-02-LWB-B

MERCEDES V-CLASS

2014-



POLISHED: V-CLASS-R1470-03
BLACK: V-CLASS-R1470-03-B



POLISHED: V-CLASS-R1470-04
BLACK: V-CLASS-R1470-04-B



POLISHED: V-CLASS-L1470-05
BLACK: V-CLASS-L1470-05-B



POLISHED: V-CLASS-L1470-08
BLACK: V-CLASS-L1470-08-B



POLISHED: V-R1476-PR-01-SWB / V-R1476-PR-01-LWB
BLACK: V-R1476-PR-01-SWB-B / V-R1476-PR-01-LWB-B

MERCEDES VITO

2003-2010



POLISHED: V-R0060-00
BLACK: V-R0060-00-B



POLISHED: V-R0060-03
BLACK: V-R0060-03-B



POLISHED: V-R0060-04
BLACK: V-R0060-04-B



POLISHED: V-R0060-06
BLACK: V-R0060-06-B



POLISHED: V-R0060-R
BLACK: V-R0060-R-B



POLISHED: V-R0076-PR-01
BLACK: V-R0076-PR-01-B



POLISHED: V-R0070-PR-02
BLACK: V-R0070-PR-02-B

MERCEDES VITO 2014-



POLISHED: VITO-R1470-04
BLACK: VITO-R1470-04-B



POLISHED: VITO-R1470-03
BLACK: VITO-R1470-03-B



POLISHED: VITO-R1470-00
BLACK: VITO-R1470-00-B



POLISHED: VITO-R1470-06
BLACK: VITO-R1470-06-B



POLISHED: VITO-L1470-05
BLACK: VITO-L1470-05-B



POLISHED: VITO-L1470-08
BLACK: VITO-L1470-08-B



POLISHED: V-R1460-R-SWB / V-R1460-R-LWB
BLACK: V-R1460-R-SWB-B / V-R1460-R-LWB-B



POLISHED: V-R1470-PR-02-SWB / V-R1470-PR-02-LWB
BLACK: V-R1470-PR-02-SWB-B / V-R1470-PR-02-LWB-B



POLISHED: V-R1476-PR-01-SWB / V-R1476-PR-01-LWB
BLACK: V-R1476-PR-01-SWB-B / V-R1476-PR-01-LWB-B

MERCEDES X-CLASS

2017-



POLISHED: X-R1770-04



POLISHED: X-R1770-06



POLISHED: X-L1770-05



POLISHED: X-R1770-03



POLISHED: X-L1770-08



POLISHED: X-R1770-00



POLISHED: X-L1770-07



POLISHED: X-R1770-R



POLISHED: X-R1770-PR-02



POLISHED fi70: X-R1776-PR-01

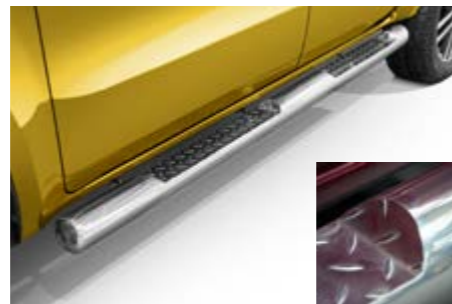

POLISHED fi100: X-R17100-PR-01

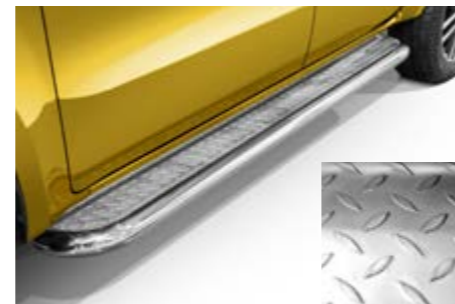

POLISHED: X-R1770-PR

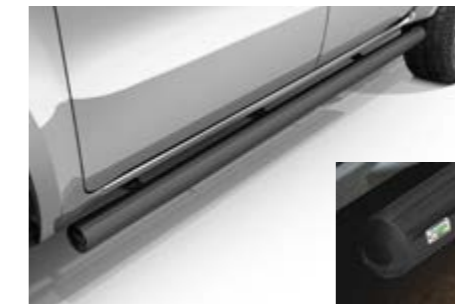

BLACK: X-R1770-R -B



BLACK: X-R1770-PR-02-B



BLACK fi70: X-R1776-PR-01-B



BLACK fi100: X-R17100-PR-01-B

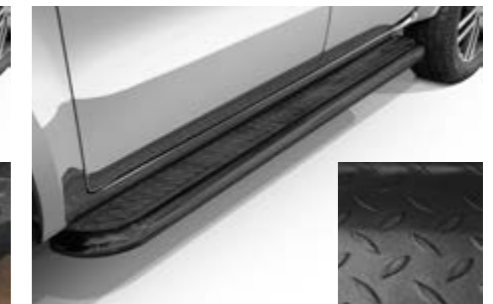

POLISHED: X-R1770-PR

MERCEDES X-CLASS

2017-



BLACK: X-R1770-06-B



BLACK: X-R1770-03-B



BLACK: X-R1770-00-B



BLACK: X-R1770-04-B



POLISHED: X-R1776-GR



BLACK: X-R1776-GR-B



BLACK: X-L1770-05-B



BLACK: X-L1770-08-B



BLACK: X-L1770-07-B



POLISHED: X-R1770-GR



BLACK: X-R1770-GR-B

MITSUBISHI ASX

2010-2013



POLISHED: ASX-R1060
BLACK: ASX-R1060-B



POLISHED: ASX-R1060-R
BLACK: ASX-R1060-R-B



POLISHED: ASX-R1060-PR-B
BLACK: ASX-R1060-PR



POLISHED: ASX-R1076-PR-01
BLACK: ASX-R1076-PR-01-B



POLISHED: ASX-R1070-PR-02
BLACK: ASX-R1070-PR-02-B

MITSUBISHI ASX

2010-2013



POLISHED: ASX-R1060-03
BLACK: ASX-R1060-03-B



POLISHED: ASX-R1060-04
BLACK: ASX-R1060-04-B



POLISHED: ASX-R1060-06
BLACK: ASX-R1060-06-B



POLISHED: ASX-R1076-03
BLACK: ASX-R1076-03-B



POLISHED: ASX-R1076-04
BLACK: ASX-R1076-04-B



POLISHED: ASX-R1048-NR
BLACK: ASX-R1048-NR-B

MITSUBISHI ASX

2012-2017



POLISHED: ASX-R1360
BLACK: ASX-R1360-B



POLISHED: ASX-R1360-R
BLACK: ASX-R1360-R-B



POLISHED: ASX-R1360-PR
BLACK: ASX-R1360-PR-B



POLISHED: ASX-R1376-PR-01
BLACK: ASX-R1376-PR-01-B



POLISHED: ASX-R1370-PR-02
BLACK: ASX-R1370-PR-02-B

MITSUBISHI ASX

2012-2017



POLISHED: ASX-R1360-03
BLACK: ASX-R1360-03-B



POLISHED: ASX-R1360-04
BLACK: ASX-R1360-04-B



POLISHED: ASX-R1376-03
BLACK: ASX-R1376-03-B



POLISHED: ASX-R1376-04
BLACK: ASX-R1376-04-B



POLISHED: ASX-R1348-NR
BLACK: ASX-R1348-NR-B

MITSUBISHI ASX

2017-



POLISHED: ASX-R1760-00
BLACK: ASX-R1760-00-B



POLISHED: ASX-R1760-R
BLACK: ASX-R1760-R-B



POLISHED: ASX-R1770-PR-02
BLACK: ASX-R1770-PR-02-B

MITSUBISHI ASX 2017-



POLISHED: ASX-R1060-03
BLACK: ASX-R1060-03-B



POLISHED: ASX-R1760-06
BLACK: ASX-R1760-06-B



POLISHED: ASX-R1760-04
BLACK: ASX-R1760-04-B



POLISHED: ASX-L1770-05
BLACK: ASX-L1770-05-B



POLISHED: ASX-L1770-08
BLACK: ASX-L1770-08-B



POLISHED: ASX-R1776-PR-01
BLACK: ASX-R1776-PR-01-B



POLISHED: ASX-R1760-PR
BLACK: ASX-R1760-PR-B

MITSUBISHI ECLIPSE CROSS 2017-



POLISHED: ECLIPSE-R1770-04
BLACK: ECLIPSE-R1770-04-B



POLISHED: ECLIPSE-R1760-R
BLACK: ECLIPSE-R1760-R-B



POLISHED: ECLIPSE-R1776-PR-01
BLACK: ECLIPSE-R1776-PR-01-B



POLISHED: ECLIPSE-R1770-PR-02
BLACK: ECLIPSE-R1770-PR-02-B

MITSUBISHI ECLIPSE CROSS

2017-



POLISHED: ECLIPSE-R1770-03
BLACK: ECLIPSE-R1770-03-B



POLISHED: ECLIPSE-R1770-06
BLACK: ECLIPSE-R1770-06-B
CAMERA COMPATIBLE POLISHED: ECLIPSE-M1770-06
CAMERA COMPATIBLE BLACK: ECLIPSE-M1770-06



POLISHED: ECLIPSE-R1770-00
BLACK: ECLIPSE-R1770-00-B



POLISHED: ECLIPSE-L1770-05
BLACK: ECLIPSE-L1770-05-B



POLISHED: ECLIPSE-L1770-07
BLACK: ECLIPSE-L1770-07-B



POLISHED: ECLIPSE-L1770-08
BLACK: ECLIPSE-L1770-08-B

MITSUBISHI L200

L200- (2006-2009) / L200N- (2009-2015)



POLISHED: L200-R0085 / L200N-R0085
BLACK: L200-R0085-B / L200N-R0085-B



POLISHED: L200-R0070-R / L200N-R0070-R
BLACK: L200-R0070-R-B / L200N-R0070-R-B



POLISHED: L200-R0076-PR-01 / L200N-R0076-PR-01
BLACK: L200-R0076-PR-01-B / L200N-R0076-PR-01-B



POLISHED: L200-R0085-PR / L200N-R0085-PR
BLACK: L200-R0085-PR-B / L200N-R0085-PR-B



POLISHED: L200-R0085-PR-03 / L200N-R0085-PR-03
BLACK: L200-R0085-PR-03-B / L200N-R0085-PR-03-B

MITSUBISHI L200

L200- (2006-2009) / L200N- (2009-2015)



POLISHED: L200-R0070-03 / L200N-R0070-03
BLACK: L200-R0070-03-B / L200N-R0070-03-B



POLISHED: L200-R0070-04 / L200N-R0070-04
BLACK: L200-R0070-04-B / L200N-R0070-04-B



POLISHED: L200-R0070-05 / L200N-R0070-05
BLACK: L200-R0070-05-B / L200N-R0070-05-B



POLISHED: L200-R0085-03 / L200N-R0085-03
BLACK: L200-R0085-03-B / L200N-R0085-03-B



POLISHED: L200-R0085-04 / L200N-R0085-04
BLACK: L200-R0085-04-B / L200N-R0085-04-B



POLISHED: L200-R0085-06 / L200N-R0085-06
BLACK: L200-R0085-06-B / L200N-R0085-06-B



POLISHED: L200-R0076-GR / L200N-R0076-GR
BLACK: L200-R0076-GR-B / L200N-R0076-GR-B



POLISHED: L200-R0085-NR-01 / L200N-R0085-NR-01
BLACK: L200-R0085-NR-01-B / L200N-R0085-NR-01-B

MITSUBISHI L200

2015-2019



POLISHED: L200-R1570-04

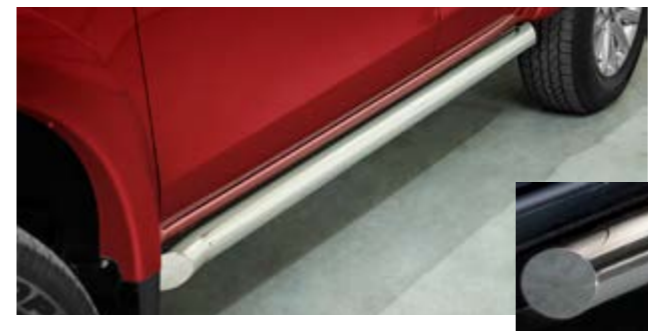

POLISHED: L200-R1576-R



POLISHED: L200-R1576-PR-01



POLISHED: L200-R1570-PR-02



POLISHED: L200-R1570-PR

MITSUBISHI L200

2015-2019



POLISHED: L200-R1570-00



POLISHED: L200-R1570-03



BLACK: L200-R1570-00-B



BLACK: L200-R1570-06-B



POLISHED: L200-R1570-06



POLISHED: L200-L1570-05



BLACK: L200-R1570-04-B



BLACK: L200-R1570-03-B



POLISHED: L200-L1570-08



POLISHED: L200-L1570-07



BLACK: L200-L1570-08-B



BLACK: L200-L1570-05-B



BLACK: L200-L1570-07-B



BLACK: L200-R1576-R-B



BLACK: L200-R1570-PR-02-B

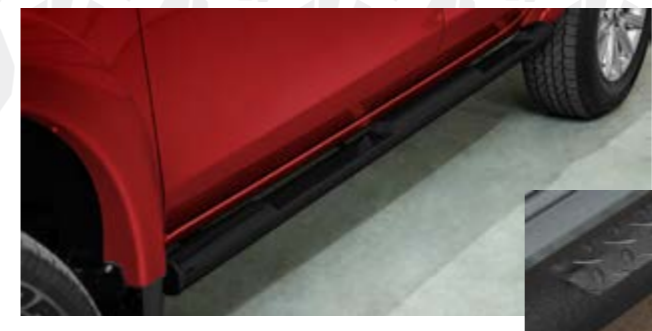

BLACK: L200-R1576-PR-01-B



BLACK: L200-R1570-PR-B

MITSUBISHI L200 2019-



POLISHED: L200-L1970-00



POLISHED: L200-R1970-03



POLISHED: L200-R1970-06



POLISHED: L200-R1970-04



POLISHED: L200-L1970-05



POLISHED: L200-L1970-07



POLISHED: L200-L1970-08



POLISHED: L200-R1576-R



POLISHED: L200-R1570-PR-02



BLACK: L200-R1576-R-B



BLACK: L200-R1570-PR-02-B



POLISHED: L200-R1576-PR-01



POLISHED: L200-R1570-PR



BLACK: L200-R1576-PR-01-B



BLACK: L200-R1570-PR-B

MITSUBISHI L200
2019-



BLACK: L200-R1970-03-B



BLACK: L200-R1570-00-B



BLACK: L200-R1970-04-B



BLACK: L200-R1970-00-B



BLACK: L200-L1970-05-B



BLACK: L200-L1970-08-B



BLACK: L200-L1970-07-B



BLACK: L200-R1576-GR-B

POLISHED: L200-R1576-GR



MITSUBISHI OUTLANDER
2007-2010



POLISHED: OT-R0060-04
BLACK: OT-R0060-04-B



POLISHED: OT-R0076-R
BLACK: OT-R0076-R-B



POLISHED: OT-R0076-PR
BLACK: OT-R0076-PR-B



POLISHED:
BLACK: OT-R0076-PR-01



POLISHED:
BLACK: OT-R0076-PR-02

MITSUBISHI OUTLANDER

2007-2010



POLISHED: OTN-R0060-06
BLACK: OTN-R0060-06-B



POLISHED: OT-R0060-00
BLACK: OT-R0060-00-B



POLISHED: OT-R0060-03
BLACK: OT-R0060-03-B



POLISHED: OT-R0070-03
BLACK: OT-R0070-03-B



POLISHED: OT-R0070-04
BLACK: OT-R0070-04-B



POLISHED: OT-R0070-05
BLACK: OT-R0070-05-B



POLISHED: OT-R0070-NR
BLACK: OT-R0070-NR-B



POLISHED: OT-R0070-NR-02
BLACK: OT-R0070-NR-02-B

MITSUBISHI OUTLANDER

2010-2012



POLISHED: OTN-R0060-00
BLACK: OTN-R0060-00-B



POLISHED: OT-R0076-R
BLACK: OT-R0076-R-B



POLISHED: OTN-R0076-PR
BLACK: OTN-R0076-PR-B



POLISHED: OTN-R0076-PR-01
BLACK: OTN-R0076-PR-01-B



POLISHED: OTN-R0076-PR-02
BLACK: OTN-R0076-PR-02-B

MITSUBISHI OUTLANDER

2010-2012



POLISHED: OTN-R0060-03
BLACK: OTN-R0060-03-B



POLISHED: OTN-R0060-04
BLACK: OTN-R0060-04-B



POLISHED:
BLACK: OTN-R0060-06



POLISHED: OTN-R0070-03
BLACK: OTN-R0070-03-B



POLISHED: OTN-R0070-05
BLACK: OTN-R0070-05-B



POLISHED: OTN-R0070-NR
BLACK: OTN-R0070-NR-B



POLISHED: OTN-R0070-NR-02
BLACK: OTN-R0070-NR-02-B

MITSUBISHI OUTLANDER

2012-2015



POLISHED: OT-R1270-04
BLACK: OT-R1270-04-B



POLISHED: OT-R1276-R
BLACK: OT-R1276-R-B



POLISHED: OT-R1276-PR-01
BLACK: OT-R1276-PR-01-B



POLISHED: OT-R1270-PR-02
BLACK: OT-R1270-PR-02-B

MITSUBISHI OUTLANDER

2012-2015



POLISHED: OT-R1270
BLACK: OT-R1270-B



POLISHED: OT-R1270-03
BLACK: OT-R1270-03-B



POLISHED: OT-R1276-04
BLACK: OT-R1276-04-B



POLISHED: OT-R1276-05
BLACK: OT-R1276-05-B



POLISHED: OT-R1276-03
BLACK: OT-R1276-03-B



POLISHED: OT-R1276-NR-01
BLACK: OT-R1276-NR-01-B



POLISHED: OT-R1276-NR
BLACK: OT-R1276-NR-B

MITSUBISHI OUTLANDER

2015-2018



POLISHED: OT-R1570-00
BLACK: OT-R1570-00-B



POLISHED: OT-R1560-R
BLACK: OT-R1560-R-B



POLISHED: OT-R1580-PR-04
BLACK: OT-R1580-PR-04-B

MITSUBISHI OUTLANDER

2015-2018



POLISHED: OT-R1570-04
BLACK: OT-R1570-04-B



POLISHED: OT-R1570-03
BLACK: OT-R1570-03-B



POLISHED: OT-L1570-05
BLACK: OT-L1570-05-B



POLISHED: OT-L1570-08
BLACK: OT-L1570-08-B



POLISHED: OT-R1548-NR-02
BLACK: OT-R1548-NR-02-B



POLISHED: OT-R1570-NR
BLACK: OT-R1570-NR-B



POLISHED: OT-R1570-PR-02
BLACK: OT-R1570-PR-02-B

MITSUBISHI OUTLANDER

2018-



POLISHED: OT-R1870-04
BLACK: OT-R1870-04-B



POLISHED: OT-R1560-R
BLACK: OT-R1560-R-B



POLISHED: OT-R1580-PR-04
BLACK: OT-R1580-PR-04-B

MITSUBISHI OUTLANDER

2018-



POLISHED: OT-R1870-03
BLACK: OT-R1870-03-B



POLISHED: OT-R1870-00
BLACK: OT-R1870-00-B



POLISHED: OT-L1870-05
BLACK: OT-L1870-05-B



POLISHED: OT-L1570-08
BLACK: OT-L1570-08-B



POLISHED: OT-R1548-NR-02
BLACK: OT-R1548-NR-02-B



POLISHED: OT-R1570-NR
BLACK: OT-R1570-NR-B



POLISHED: OT-R1870-PR-02
BLACK: OT-R1870-PR-02-B

MITSUBISHI PAJERO

2007-2014



POLISHED: PAJERO-R0070-00
BLACK: PAJERO-R0070-00-B



POLISHED: PAJERO-R0048-R
BLACK: PAJERO-R0048-R-B



POLISHED: PAJERO-R0070-PR
BLACK: PAJERO-R0070-PR-B

MITSUBISHI PAJERO

2007-2014



POLISHED: PAJERO-R0070-03
BLACK: PAJERO-R0070-03-B



POLISHED: PAJERO-R0070-04
BLACK: PAJERO-R0070-04-B



POLISHED: PAJERO-R0076-03
BLACK: PAJERO-R0076-03-B



POLISHED: PAJERO-R0076-04
BLACK: PAJERO-R0076-04-B



POLISHED: PAJERO-R0076-06
BLACK: PAJERO-R0076-06-B



POLISHED: PAJERO-R0070-NR
BLACK: PAJERO-R0070-NR-B

MITSUBISHI PAJERO

2014-



POLISHED: PAJERO-R0070-00
BLACK: PAJERO-R0070-00-B



POLISHED: PAJERO-R0070-PR
BLACK: PAJERO-R0070-PR-B



POLISHED: PAJERO-R0070-PR-03
BLACK: PAJERO-R0070-PR-03-B

MITSUBISHI PAJERO

2014-



POLISHED: PAJERO-R0070-04
BLACK: PAJERO-R0070-04-B



POLISHED: PAJERO-R0070-03
BLACK: PAJERO-R0070-03-B



POLISHED: PAJERO-R0070-06
BLACK: PAJERO-R0070-06-B



POLISHED: PAJERO-R1476-03
BLACK: PAJERO-R1476-03-B



POLISHED: PAJERO-R1476-06
BLACK: PAJERO-R1476-06-B



POLISHED: PAJERO-R1476-04
BLACK: PAJERO-R1476-04-B

POLISHED: PAJERO-R1470-NR
BLACK: PAJERO-R1470-NR-B



NISSAN JUKE

2010-2014



POLISHED: JUKE-R1060-04
BLACK: JUKE-R1060-04-B



POLISHED: JUKE-R1060-03
BLACK: JUKE-R1060-03-B



POLISHED: JUKE-R1060-R
BLACK: JUKE-R1060-R-B



POLISHED: JUKE-R1070-05
BLACK: JUKE-R1070-05-B



POLISHED: JUKE-R1076-PR-01
BLACK: JUKE-R1076-PR-01-B



POLISHED: JUKE-R1048-NR
BLACK: JUKE-R1048-NR-B



POLISHED: JUKE-R1070-PR-02
BLACK: JUKE-R1070-PR-02-B

NISSAN NAVARA

D40- (2005-2010) / D40N- (2010-2015)



POLISHED: D40-R0085-00 / D40N-R0085-00 / D40N-R0085-00-V6
BLACK: D40-R0085-00-B / D40N-R0085-00-B / D40N-R0085-00-V6-B



POLISHED: D40-R0085-PR / D40N-R0085-PR
BLACK: D40-R0085-PR-B / D40N-R0085-PR-B



POLISHED: D40-R0085-NR-01 / D40N-R0085-NR-01
BLACK: D40-R0085-NR-01-B / D40N-R0085-NR-01-B



POLISHED: D40-R0076-GR / D40N-R0076-GR
BLACK: D40-R0076-GR-B / D40N-R0076-GR-B



POLISHED: D40-R0085-03 / D40N-R0085-03 / D40N-R0085-03-V6
BLACK: D40-R0085-03-B / D40N-R0085-03-B / D40N-R0085-03-V6-B



POLISHED: D40-R0085-04 / D40N-R0085-04 / D40N-R0085-04-V6
BLACK: D40-R0085-04-B / D40N-R0085-04-B / D40N-R0085-04-V6-B



POLISHED: D40-R0085-06 / D40N-R0085-06 / D40N-R0085-06-V6
BLACK: D40-R0085-06-B / D40N-R0085-06-B / D40N-R0085-06-V6-B



POLISHED: D40-R0085-05 / D40N-R0085-05
BLACK: D40-R0085-05-B / D40N-R0085-05-B



POLISHED: D40-R0076-GR-01 / D40N-R0076-GR-01
BLACK: D40-R0076-GR-01-B / D40N-R0076-GR-01-B

NISSAN NAVARA NP300

2015-



POLISHED: NP300-L1570-08



POLISHED: NP300-R1570-00



POLISHED: NP300-R1570-04



POLISHED: NP300-R1570-03



POLISHED: NP300-R1570-06



POLISHED: NP300-L1570-05



POLISHED: NP300-R1548-R



POLISHED: NP300-R1576-PR-01



BLACK: NP300-R1548-R-B



BLACK: NP300-R1576-PR-01-B



POLISHED: NP300-R1570-PR-02



POLISHED: NP300-R1570-PR



BLACK: NP300-R1570-PR-02-B



BLACK: NP300-R1570-PR-B

NISSAN NAVARA NP300

2015-



BLACK: NP300-R1570-00-B



BLACK: NP300-R1570-04-B



BLACK: NP300-R1570-03-B



BLACK: NP300-R1570-06-B



BLACK: NP300-L1570-05-B



BLACK: NP300-L1570-08-B

POLISHED: NP300-R1576-GR
BLACK: NP300-R1576-GR-B



POLISHED: NP300-L1570-NR-01
BLACK: NP300-L1570-NR-01-B

NISSAN PATHFINDER

PATH- (2005-2010) / PATHN- (2010-)



POLISHED:
PATH-R0085-00 / PATHN-R0085-00 / PATHN-R0085-V6
BLACK:
PATH-R0085-00-B / PATHN-R0085-00-B / PATHN-R0085-V6-B



POLISHED:
PATH-R0085-03 / PATHN-R0085-03 / PATHN-R0085-03-V6
BLACK:
PATH-R0085-03-B / PATHN-R0085-03-B / PATHN-R0085-03-V6-B



POLISHED:
PATH-R0085-04 / PATHN-R0085-04 / PATHN-R0085-04-V6
BLACK:
PATH-R0085-04-B / PATHN-R0085-04-B / PATHN-R0085-04-V6-B



POLISHED:
PATH-R0085-06 / PATHN-R0085-06 / PATHN-R0085-06-V6
BLACK:
PATH-R0085-06-B / PATHN-R0085-06-B / PATHN-R0085-06-V6-B



POLISHED: PATH-R0085-05 / PATHN-R0085-05
BLACK: PATH-R0085-05-B / PATHN-R0085-05-B



POLISHED: PATH-R0048-R / PATHN-R0048-R
BLACK: PATH-R0048-R-B / PATHN-R0048-R-B



POLISHED: PATH-R0085-NR-01 / PATHN-R0085-NR-01
BLACK: PATH-R0085-NR-01-B / PATHN-R0085-NR-01-B



POLISHED: PATH-R0085-PR / PATHN-R0085-PR
BLACK: PATH-R0085-PR-B / PATHN-R0085-PR-B

NISSAN QASHQAI

2007-2010



POLISHED: QUA-R0060-00
BLACK: QUA-R0060-00-B



POLISHED: QUA-R0060-03
BLACK: QUA-R0060-03-B



POLISHED: QUA-R0060-04
BLACK: QUA-R0060-04-B



POLISHED: QUA-R0060-06
BLACK: QUA-R0060-06-B



POLISHED: QUA-R0070-03
BLACK: QUA-R0070-03-B



POLISHED: QUA-R0070-04
BLACK: QUA-R0070-04-B



POLISHED: QUA-R0048-R
BLACK: QUA-R0048-R-B



POLISHED: QUA-R0076-PR
BLACK: QUA-R0076-PR-B



POLISHED: QUA-R0076-PR-01
BLACK: QUA-R0076-PR-01-B



POLISHED: QUA-R0076-PR-02
BLACK: QUA-R0076-PR-02-B



POLISHED: QUA-R0076-NR
BLACK: QUA-R0076-NR-B

NISSAN QASHQAI

2010-2013



POLISHED: QUAN-R0060-00
BLACK: QUAN-R0060-00-B



POLISHED: QUAN-R0048-R / QUAN+2-R0048-R
BLACK: QUAN-R0048-R-B / QUAN+2-R0048-R-B



POLISHED: QUAN-R0076-PR / QUAN+2-R0076-PR
BLACK: QUAN-R0076-PR-B / QUAN+2-R0076-PR-B



POLISHED: QUAN-R0076-PR-01 / QUAN+2-R0076-PR-01
BLACK: QUAN-R0076-PR-01-B / QUAN+2-R0076-PR-01-B



POLISHED: QUAN-R0076-PR-02 / QUAN+2-R0076-PR-02
BLACK: QUAN-R0076-PR-02-B / QUAN+2-R0076-PR-02-B



POLISHED: QUAN-R0060-03
BLACK: QUAN-R0060-03-B



POLISHED: QUAN-R0060-04
BLACK: QUAN-R0060-04-B



POLISHED: QUAN-R0060-06
BLACK: QUAN-R0060-06-B



POLISHED: QUAN-R0070-03
BLACK: QUAN-R0070-03 -B



POLISHED: QUAN-R0070-04
BLACK: QUAN-R0070-04-B

POLISHED: QUAN-R0076-NR / QUAN+2-R0076-NR
BLACK: QUAN-R0076-NR-B / QUAN+2-R0076-NR-B



NISSAN QASHQAI 2013-2017



POLISHED: QUA-L1360-08
BLACK: QUA-L1360-08-B



POLISHED: QUA-R1360
BLACK: QUA-R1360-B



POLISHED: QUA-R1360-03
BLACK: QUA-R1360-03



POLISHED: QUA-R1360-04
BLACK: QUA-R1360-04-B



POLISHED: QUA-L1360-05
BLACK: QUA-L1360-05-B



POLISHED: QUA-R1360-06
BLACK: QUA-R1360-06-B



POLISHED: QUA-R1360-R
BLACK: QUA-R1360-R-B



POLISHED: QUA-R1360-PR
BLACK: QUA-R1360-PR-B



POLISHED: QUA-R1376-PR-01
BLACK: QUA-R1376-PR-01-B



POLISHED: QUA-R1370-PR-02
BLACK: QUA-R1370-PR-02-B



POLISHED: QUA-R1360-NR
BLACK: QUA-R1360-NR-B

NISSAN QASHQAI 2017-



POLISHED: QUA-R1770-06
BLACK: QUA-R1770-06 B



POLISHED: QUA-L1760-S
BLACK: QUA-L1760-S -B



POLISHED: QUA-L1760-05
BLACK: QUA-L1760-05 -B

POLISHED: QUA-L1760-08
BLACK: QUA-L1760-08 -B



POLISHED: QUA-R1776-PR-01
BLACK: QUA-R1776-PR-01-B



POLISHED: QUA-R1770-PR-02
BLACK: QUA-R1770-PR-02-B



POLISHED: QUA-R1760-R
BLACK: QUA-R1760-R-B



POLISHED: QUA-R1760-PR
BLACK: QUA-R1760-PR -B



NISSAN X-TRAIL

R-00 (2007-2010) / R-10 (2010-2014)



POLISHED: X-TRAIL-R0076-06 / X-TRAIL-R1076-06
BLACK: X-TRAIL-R0076-06-B / X-TRAIL-R1076-06-B



POLISHED: X-TRAIL-R0070-R / X-TRAIL-R1070-R
BLACK: X-TRAIL-R0070-R-B / X-TRAIL-R1070-R-B



POLISHED: X-TRAIL-R0070-PR / X-TRAIL-R1070-PR
BLACK: X-TRAIL-R0070-PR-B / X-TRAIL-R1070-PR-B



POLISHED: X-TRAIL-R0070-PR-01 / X-TRAIL-R1070-PR-01
BLACK: X-TRAIL-R0070-PR-01-B / X-TRAIL-R1070-PR-01-B



POLISHED:
BLACK: X-TRAIL-R0070-PR-02 / X-TRAIL-R1070-PR-02



POLISHED: X-TRAIL-R0070 / X-TRAIL-R1070
BLACK: X-TRAIL-R0070-B / X-TRAIL-R1070-B



POLISHED: X-TRAIL-R0070-03 / X-TRAIL-R1070-03
BLACK: X-TRAIL-R0070-03-B / X-TRAIL-R1070-03-B



POLISHED: X-TRAIL-R0070-04 / X-TRAIL-R1070-04
BLACK: X-TRAIL-R0070-04-B / X-TRAIL-R1070-04-B



POLISHED: X-TRAIL-R0070-06 / X-TRAIL-R1070-06
BLACK: X-TRAIL-R0070-06-B / X-TRAIL-R1070-06-B



POLISHED: X-TRAIL-R0076-03 / X-TRAIL-R1076-03
BLACK: X-TRAIL-R0076-03-B / X-TRAIL-R1076-03-B



POLISHED: X-TRAIL-R0076-04 / X-TRAIL-R1076-04
BLACK: X-TRAIL-R0076-04-B / X-TRAIL-R1076-04-B



POLISHED: X-TRAIL-R0070-NR / X-TRAIL-R1070-NR
BLACK: X-TRAIL-R0070-NR-B / X-TRAIL-R1070-NR-B

NISSAN X-TRAIL 2014-2017



POLISHED: X-TRAIL-R1470
BLACK: X-TRAIL-R1470-B



POLISHED: X-TRAIL-R1470-03
BLACK: X-TRAIL-R1470-03-B



POLISHED: X-TRAIL-R1470-04
BLACK: X-TRAIL-R1470-04-B



POLISHED: X-TRAIL-R1470-06
BLACK: X-TRAIL-R1470-06-B



POLISHED: X-TRAIL-R1460-R
BLACK: X-TRAIL-R1460-R-B

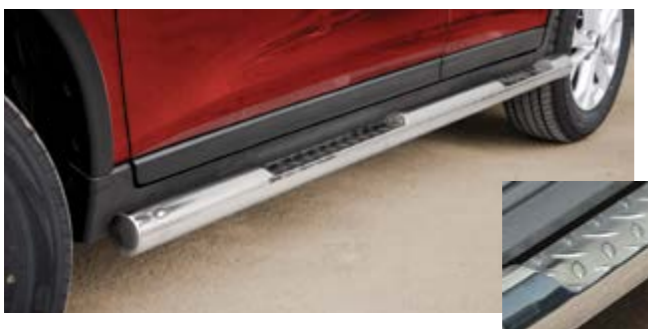

POLISHED: X-TRAIL-R1476-PR-01
BLACK: X-TRAIL-R1476-PR-01-B



POLISHED: X-TRAIL-R1470-PR-02
BLACK: X-TRAIL-R1470-PR-02-B



POLISHED: X-TRAIL-R1470-NR
BLACK: X-TRAIL-R1470-NR-B

OPEL CROSSLAND X
2017-



POLISHED: CROSSLAND-L1660-08
BLACK: CROSSLAND-L1660-08-B



POLISHED: CROSSLAND-R1660-R
BLACK: CROSSLAND-R1660-R -B



POLISHED: CROSSLAND-R1676-PR-01
BLACK: CROSSLAND-R1676-PR-01 -B



POLISHED: CROSSLAND-L1660-05
BLACK: CROSSLAND-L1660-05-B



POLISHED: CROSSLAND-R1670-PR-02
BLACK: CROSSLAND-R1670-PR-02-B

OPEL VIVARO
2014-



POLISHED: RON-R1460-00
BLACK: RON-R1460-00-B



POLISHED: RON-R1470-R
BLACK: RON-R1470-R -B



POLISHED: RON-R1470-PR-02
BLACK: RON-R1470-PR-02-B

OPEL VIVARO 2014-



POLISHED: RON-R1460-03
BLACK: RON-R1460-03-B



POLISHED: RON-R1460-06
BLACK: RON-R1460-06-B



POLISHED: RON-R1460-04
BLACK: RON-R1460-04-B



POLISHED: RON-R1476-PR-01
BLACK: RON-R1476-PR-01-B

REANULT KADJAR 2016-



POLISHED: KADJAR-N1560-10
BLACK: KADJAR-N1560-10-B



POLISHED: KADJAR-R1560-R
BLACK: KADJAR-R1560-R-B



POLISHED: KADJAR-R1570-PR-02
BLACK: KADJAR-R1570-PR-02-B

REANAUULT KADJAR 2016-



POLISHED: KADJAR-N1560-09
BLACK: KADJAR-N1560-09-B



POLISHED: KADJAR-L1560-08
BLACK: KADJAR-L1560-08-B



POLISHED: KADJAR-R1576-PR-01
BLACK: KADJAR-R1576-PR-01-B

REANAUULT MASTER 2010-



POLISHED: MASTER-R1070
BLACK: MASTER-R1070-B



POLISHED: MASTER-R1070-03
BLACK: MASTER-R1070-03-B



POLISHED: MASTER-R1070-04
BLACK: MASTER-R1070-04-B



POLISHED: MASTER-R1070-R
BLACK: MASTER-R1070-R-B



POLISHED: MASTER-R1076-PR-01
BLACK: MASTER-R1076-PR-01-B



POLISHED: MASTER-R1070-PR-02
BLACK: MASTER-R1070-PR-02-B

SSANGYONG MUSSO

2018-



POLISHED: MUSSO-L1870-08
BLACK: MUSSO-L1870-08-B



POLISHED: MUSSO-R1870-03
BLACK: MUSSO-R1870-03-B



POLISHED: RAV4-R1870-06
BLACK: RAV4-R1870-06-B



POLISHED: MUSSO-L1870-05
BLACK: MUSSO-L1870-05-B



POLISHED: MUSSO-L1870-07
BLACK: MUSSO-L1870-07-B



POLISHED: MUSSO-R1876-GR
BLACK: MUSSO-R1876-GR



POLISHED: MUSSO-R1860-R
BLACK: MUSSO-R1860-R-B



POLISHED: MUSSO-R1870-PR
BLACK: MUSSO-R1870-PR-B



POLISHED: MUSSO-R1876-PR-01
BLACK: MUSSO-R1876-PR-01-B



POLISHED: MUSSO-R1870-PR-02
BLACK: MUSSO-R1870-PR-02-B

SSANGYONG REXTON 2018-



POLISHED: REXTON-L1870-08
BLACK: REXTON-L1870-08-B



POLISHED: REXTON-R1870-03
BLACK: REXTON-R1870-03-B



POLISHED: REXTON-L1870-05
BLACK: REXTON-L1870-05-B



POLISHED: REXTON-L1870-07
BLACK: REXTON-L1870-07-B



POLISHED: REXTON-R1860-R
BLACK: REXTON-R1860-R-B



POLISHED: REXTON-R1870-PR
BLACK: REXTON-R1870-PR-B



POLISHED: REXTON-R1876-PR-01
BLACK: REXTON-R1876-PR-01-B



POLISHED: REXTON-R1870-PR-02
BLACK: REXTON-R1870-PR-02-B

SEAT ATECA 2016-



POLISHED: ATECA-L1660-08
BLACK: ATECA-L1660-08-B



POLISHED: ATECA-N1660-09
BLACK: ATECA-N1660-09-B



POLISHED: ATECA-N1660-10
BLACK: ATECA-N1660-10-B



POLISHED: ATECA-L1660-05
BLACK: ATECA-L1660-05-B



POLISHED: ATECA-L1660-07
BLACK: ATECA-L1660-07-B



POLISHED: ATECA-R1660-R
BLACK: ATECA-R1660-R-B



POLISHED: ATECA-R1670-PR-02
BLACK: ATECA-R1670-PR-02-B

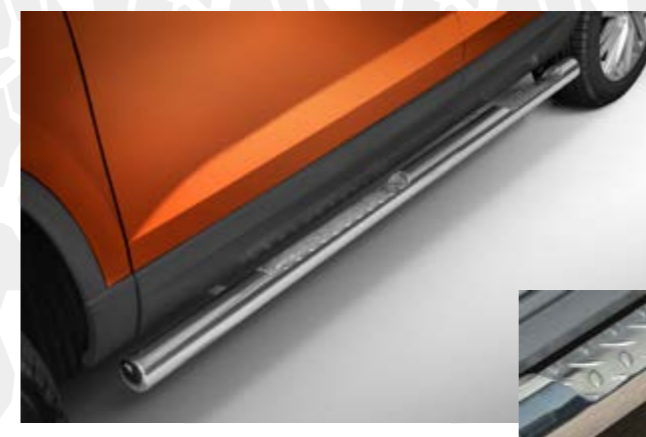

POLISHED: ATECA-R1676-PR-01
BLACK: ATECA-R1676-PR-01-B

SKODA KODIAQ 2016-



POLISHED: KODIAQ-R1660-04
BLACK: KODIAQ-R1660-04-B

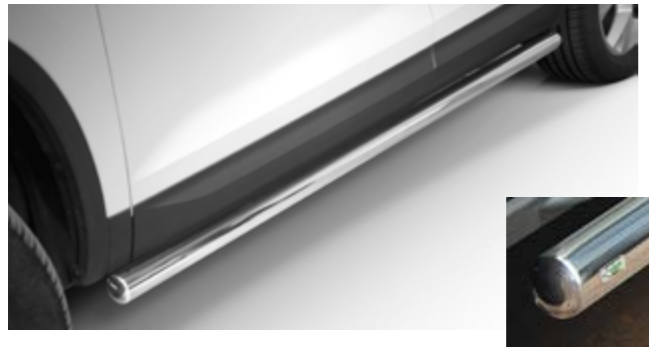

POLISHED: KODIAQ-R1660-R
BLACK: KODIAQ-R1660-R-B

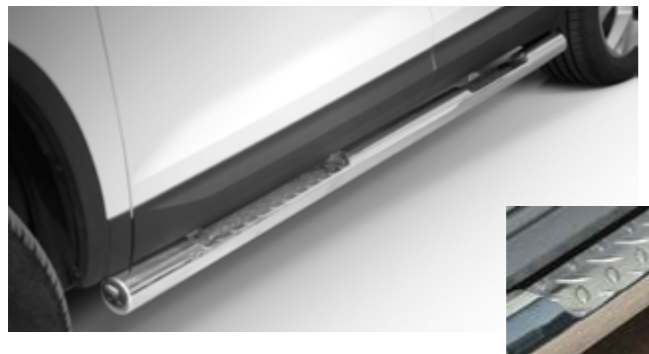

POLISHED: KODIAQ-R1676-PR-01
BLACK: KODIAQ-R1676-PR-01-B

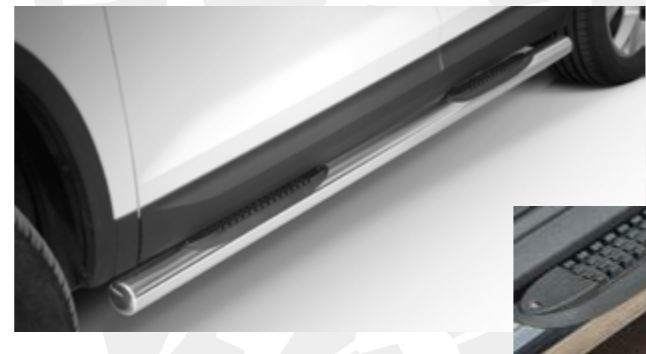

POLISHED: KODIAQ-R1670-PR-02
BLACK: KODIAQ-R1670-PR-02-B



POLISHED: KODIAQ-R1660-03
BLACK: KODIAQ-R1660-03-B



POLISHED: KODIAQ-R1660-06
BLACK: KODIAQ-R1660-06-B



POLISHED: KODIAQ-R1660-00
BLACK: KODIAQ-R1660-00-B



POLISHED: KODIAQ-L1660-05
BLACK: KODIAQ-L1660-05-B



POLISHED: KODIAQ-L1660-08
BLACK: KODIAQ-L1660-08-B



POLISHED: KODIAQ-N1660-09
BLACK: KODIAQ-N1660-09-B



POLISHED: KODIAQ-N1660-10
BLACK: KODIAQ-N1660-10-B

SUBARU FORESTER 2008-2012



POLISHED: FORESTER-R0070
BLACK: FORESTER-R0070-B



POLISHED: FORESTER-R0070-03
BLACK: FORESTER-R0070-03-B



POLISHED: FORESTER-R0070-04
BLACK: FORESTER-R0070-04-B



POLISHED: FORESTER-R0070-05
BLACK: FORESTER-R0070-05-B



POLISHED: FORESTER-R0070-07
BLACK: FORESTER-R0070-07-B



POLISHED: FORESTER-R0070-08
BLACK: FORESTER-R0070-08-B



POLISHED: FORESTER-R0060-R
BLACK: FORESTER-R0060-R-B



POLISHED: FORESTER-R0076-PR-01
BLACK: FORESTER-R0076-PR-01-B



POLISHED: FORESTER-R0070-PR-02
BLACK: FORESTER-R0070-PR-02-B



POLISHED: FORESTER-R0070-NR
BLACK: FORESTER-R0070-NR-B

SUBARU FORESTER

2013-2016



POLISHED: FORESTER-R1370-04
BLACK: FORESTER-R1370-04-B



POLISHED: FORESTER-R1370
BLACK: FORESTER-R1370-B



POLISHED: FORESTER-R1370-03
BLACK: FORESTER-R1370-03-B



POLISHED: FORESTER-R1370-06
BLACK: FORESTER-R1370-06-B



POLISHED: FORESTER-R1376
BLACK: FORESTER-R1376-B



POLISHED: FORESTER-R1376-04
BLACK: FORESTER-R1376-04-B



POLISHED: FORESTER-R1376-06
BLACK: FORESTER-R1376-06-B

POLISHED: FORESTER-R1348-NR
BLACK: FORESTER-R1348-NR-B



POLISHED: FORESTER-R1360-R
BLACK: FORESTER-R1360-R-B



POLISHED: FORESTER-R1360-PR
BLACK: FORESTER-R1360-PR-B



POLISHED: FORESTER-R1376-PR-01
BLACK: FORESTER-R1376-PR-01-B



POLISHED: FORESTER-R1370-PR-02
BLACK: FORESTER-R1370-PR-02-B



SUBARU FORESTER 2016-



POLISHED: FORESTER-R1370-03
BLACK: FORESTER-R1370-03-B



POLISHED: FORESTER-R1370-06
BLACK: FORESTER-R1370-06-B



POLISHED: FORESTER-R1370
BLACK: FORESTER-R1370-B



POLISHED: FORESTER-R1376-06
BLACK: FORESTER-R1376-06-B



POLISHED: FORESTER-R1376
BLACK: FORESTER-R1376-B

POLISHED: FORESTER-R1376-04
BLACK: FORESTER-R1376-04-B



POLISHED: FORESTER-R1360-R
BLACK: FORESTER-R1360-R-B



POLISHED: FORESTER-R1360-PR
BLACK: FORESTER-R1360-PR-B



POLISHED: FORESTER-R1376-PR-01
BLACK: FORESTER-R1376-PR-01-B



POLISHED: FORESTER-R1370-PR-02
BLACK: FORESTER-R1370-PR-02-B



POLISHED: FORESTER-R1360-R
BLACK: FORESTER-R1360-R-B



POLISHED: FORESTER-R1360-PR
BLACK: FORESTER-R1360-PR-B

SUZUKI GRAND VITARA

2006-2015



POLISHED: VITARA-R0076-00
BLACK: VITARA-R0076-00-B



POLISHED: VITARA-R0076-R
BLACK: VITARA-R0076-R-B



POLISHED: VITARA-R0076-PR-01
BLACK: VITARA-R0076-PR-01-B



POLISHED: VITARA-R0076-PR-02
BLACK: VITARA-R0076-PR-02-B



POLISHED: VITARA-R0076-PR-03
BLACK: VITARA-R0076-PR-03-B



POLISHED: VITARA-R0070-03
BLACK: VITARA-R0070-03-B



POLISHED: VITARA-R0070-04
BLACK: VITARA-R0070-04-B



POLISHED: VITARA-R0070-06
BLACK: VITARA-R0070-06-B



POLISHED: VITARA-R0076-03
BLACK: VITARA-R0076-03-B



POLISHED: VITARA-R0076-04
BLACK: VITARA-R0076-04-B



POLISHED: VITARA-R0076-06
BLACK: VITARA-R0076-06-B



POLISHED: VITARA-R0076-NR-01
BLACK: VITARA-R0076-NR-01-B



POLISHED: JIMNY-R0070-04
BLACK: JIMNY-R0070-04-B



POLISHED: JIMNY-R0070
BLACK: JIMNY-R0070-B



POLISHED: JIMNY-R0070-03
BLACK: JIMNY-R0070-03-B



POLISHED: JIMNY-R0070-06
BLACK: JIMNY-R0070-06-B



POLISHED: JIMNY-R0076-04
BLACK: JIMNY-R0076-04-B



POLISHED: JIMNY-R0076-06
BLACK: JIMNY-R0076-06-B



POLISHED: JIMNY-R0070-R
BLACK: JIMNY-R0070-R-B



POLISHED: JIMNY-R0070-PR
BLACK: JIMNY-R0070-PR-B



POLISHED: JIMNY-R0076-PR-01
BLACK: JIMNY-R0076-PR-01-B



POLISHED: JIMNY-R0070-PR-02
BLACK: JIMNY-R0070-PR-02-B

SUZUKI JIMNY

2012-2018



POLISHED: JIMNY-R1270-00
BLACK: JIMNY-R1270-00-B



POLISHED: JIMNY-R1270-R
BLACK: JIMNY-R1270-R-B



POLISHED: JIMNY-R1276-PR-01
BLACK: JIMNY-R1276-PR-01-B



POLISHED: JIMNY-R1270-PR-02
BLACK: JIMNY-R1270-PR-02-B



POLISHED: JIMNY-R1270-03
BLACK: JIMNY-R1270-03-B



POLISHED: JIMNY-R1270-04
BLACK: JIMNY-R1270-04-B



POLISHED: JIMNY-R1270-06
BLACK: JIMNY-R1270-06-B



POLISHED: JIMNY-R1276-03
BLACK: JIMNY-R1276-03-B



POLISHED: JIMNY-R1276-04
BLACK: JIMNY-R1276-04-B



POLISHED: JIMNY-R1276-06
BLACK: JIMNY-R1276-06-B



POLISHED: JIMNY-R1270-PR
BLACK: JIMNY-R1270-PR-B



POLISHED: JIMNY-R1270-PR-03
BLACK: JIMNY-R1270-PR-03-B

SUZUKI JIMNY 2018-



POLISHED: JIMNY-R1870-00
BLACK: JIMNY-R1870-00-B



POLISHED: JIMNY-R1870-03
BLACK: JIMNY-R1870-03-B



POLISHED: JIMNY-R1870-06
BLACK: JIMNY-R1870-06-B



POLISHED: JIMNY-N1860-09
BLACK: JIMNY-N1860-09



POLISHED: JIMNY-R1870-04
BLACK: JIMNY-R1870-04-B



POLISHED: JIMNY-N1860-10
BLACK: JIMNY-N1860-10-B



POLISHED: JIMNY-L1860-05
BLACK: JIMNY-L1860-05_B



POLISHED: JIMNY-R1860-R
BLACK: JIMNY-R1860-R-B



POLISHED: JIMNY-R1860-PR
BLACK: JIMNY-R1860-PR-B



POLISHED: JIMNY-R1876-PR-01
BLACK: JIMNY-R1876-PR-01-B



POLISHED: JIMNY-R1876-PR-02
BLACK: JIMNY-R1876-PR-02-B



POLISHED: JIMNY-R1860-NR-02
BLACK: JIMNY-R1860-NR-02-B

SUZUKI SX4
2006-2013



POLISHED: SX4-R0060-04
BLACK: SX4-R0060-04-B



POLISHED: SX4-R0060-03
BLACK: SX4-R0060-03-B

POLISHED: SX4-R0070-04
BLACK: SX4-R0070-04-B

POLISHED: SX4-R0070-06
BLACK: SX4-R0070-06-B



POLISHED: SX4-R0060-R
BLACK: SX4-R0060-R-B

POLISHED: SX4-R0070-PR-02
BLACK: SX4-R0070-PR-02-B

POLISHED: SX4-R0076-PR-01
BLACK: SX4-R0076-PR-01-B

SUZUKI SX4 S-CROSS
2013-2016



POLISHED: S-CROSS-R1360-08
BLACK: S-CROSS-R1360-08-B



POLISHED: S-CROSS-R1360-R
BLACK: S-CROSS-R1360-R-B

POLISHED: S-CROSS-R1376-PR-01
BLACK: S-CROSS-R1376-PR-01-B

SUZUKI SX4 S-CROSS

2013-2016



POLISHED: S-CROSS-R1360
BLACK: S-CROSS-R1360-B



POLISHED: S-CROSS-R1360-03
BLACK: S-CROSS-R1360-03-B



POLISHED: S-CROSS-R1360-04
BLACK: S-CROSS-R1360-04-B



POLISHED: S-CROSS-R1360-05
BLACK: S-CROSS-R1360-05-B



POLISHED: S-CROSS-R1370-PR-02
BLACK: S-CROSS-R1370-PR-02-B

SUZUKI SX4 S-CROSS

2016-



POLISHED: S-CROSS-R1660-00
BLACK: S-CROSS-R1660-00 -B



POLISHED: S-CROSS-R1676-PR-01
BLACK: S-CROSS-R1676-PR-01 -B



POLISHED: S-CROSS-R1660-R
BLACK: S-CROSS-R1660-R -B

SUZUKI SX4 S-CROSS 2016-



POLISHED: S-CROSS-R1660-03
BLACK: S-CROSS-R1660-03 -B



POLISHED: S-CROSS-R1660-06
BLACK: S-CROSS-R1660-06 -B



POLISHED: S-CROSS-R1660-04
BLACK: S-CROSS-R1660-04 -B



POLISHED: S-CROSS-L1660-05
BLACK: S-CROSS-L1660-05 -B



POLISHED: S-CROSS-L1660-08
BLACK: S-CROSS-L1660-08 -B



POLISHED: S-CROSS-R1670-PR-02
BLACK: S-CROSS-R1670-PR-02-B

SUZUKI VITARA 2015-2018



POLISHED: VITARA-R1560-00
BLACK: VITARA-R1560-00-B



POLISHED: VITARA-R1560-03
BLACK: VITARA-R1560-03-B



POLISHED: VITARA-R1560-04
BLACK: VITARA-R1560-04-B



POLISHED: VITARA-R1560-05
BLACK: VITARA-R1560-05-B



POLISHED: VITARA-R1560-08
BLACK: VITARA-R1560-08-B

SUZUKI VITARA
2015-2018



POLISHED: VITARA-R1560-R
BLACK: VITARA-R1560-R-B



POLISHED: VITARA-R1576-PR-01
BLACK: VITARA-R1576-PR-01-B



POLISHED: VITARA-R1570-PR-02
BLACK: VITARA-R1570-PR-02-B



POLISHED: VITARA-R1548-NR
BLACK: VITARA-R1548-NR -B

SUZUKI VITARA
2018-



POLISHED: VITARA-R1860-04
BLACK: VITARA-R1860-04-B



POLISHED: VITARA-R1860-03
BLACK: VITARA-R1860-03-B



POLISHED: VITARA-R1860-06
BLACK: VITARA-R1860-06 -B



POLISHED: VITARA-R1860-00
BLACK: VITARA-R1860-00-B



POLISHED: VITARA-L1860-05
BLACK: VITARA-L1860-05-B

SUZUKI VITARA 2018-



POLISHED: VITARA-R1560-R
BLACK: VITARA-R1560-R-B



POLISHED: VITARA-R1576-PR-01
BLACK: VITARA-R1576-PR-01 -B



POLISHED: VITARA-R1570-PR-02
BLACK: VITARA-R1570-PR-02-B

TOYOTA HILUX 2005-2011-2015



POLISHED: DKUN-R0085-00
BLACK: DKUN-R0085-00-B



POLISHED: DKUN-R0085-R
BLACK: DKUN-R0085-R-B



POLISHED: DKUN-R0085-PR
BLACK: DKUN-R0085-PR-B



POLISHED: DKUN-R0085-PR-01
BLACK: DKUN-R0085-PR-01-B



POLISHED: DKUN-R0085-PR-02
BLACK: DKUN-R0085-PR-02-B

TOYOTA HILUX

2005-2011-2015



POLISHED: DKUN-R0076-04
BLACK: DKUN-R0076-04-B



POLISHED: DKUN-R0076-05
BLACK: DKUN-R0076-05-B



POLISHED: DKUN-R0076-06
BLACK: DKUN-R0076-06-B



POLISHED: DKUN-R0085-03
BLACK: DKUN-R0085-03-B



POLISHED: DKUN-R0085-04
BLACK: DKUN-R0085-04-B



POLISHED: DKUN-R0085-06
BLACK: DKUN-R0085-06-B



POLISHED: DKUN-R0076-GR
BLACK: DKUN-R0076-GR-B



POLISHED: DKUN-R0085-NR-01
BLACK: DKUN-R0085-NR-01-B

Toyota Hilux - AT35



AT35 CONVERSION

The Toyota Hilux AT35 is based on the well known and worldwide Toyota Hilux. In order to fit the larger 315x70 R17 off-road tires the front and rear suspension is lifted 40 mm and the wheel arches are cut up and made larger. Tailor made fender flares are fitted to cover the large tires. The side steps are extended to match the fender flares.

The modifications are design in such a way that the vehicle will keep all its original functions and still get better drivability, both on and off-road. All parts are either genuine Toyota parts or special parts fabricated from high grade material and designed by strict standards.

AT35 CONTENTS

- 315x70 R17" tires BFG AT KO2 or Nokian Hakkapeliitta LT2 „Arctic Trucks”
- 17x10" alloy wheels
- Torque wrench
- Fender flares, painted
- Running boards and brackets
- Mud flaps
- Speedometer calibrator
- 40 mm suspension lift, front/rear
- Fender trimming, front/rear
- First aid kit
- Wheel alignment

AFTER CONVERSION

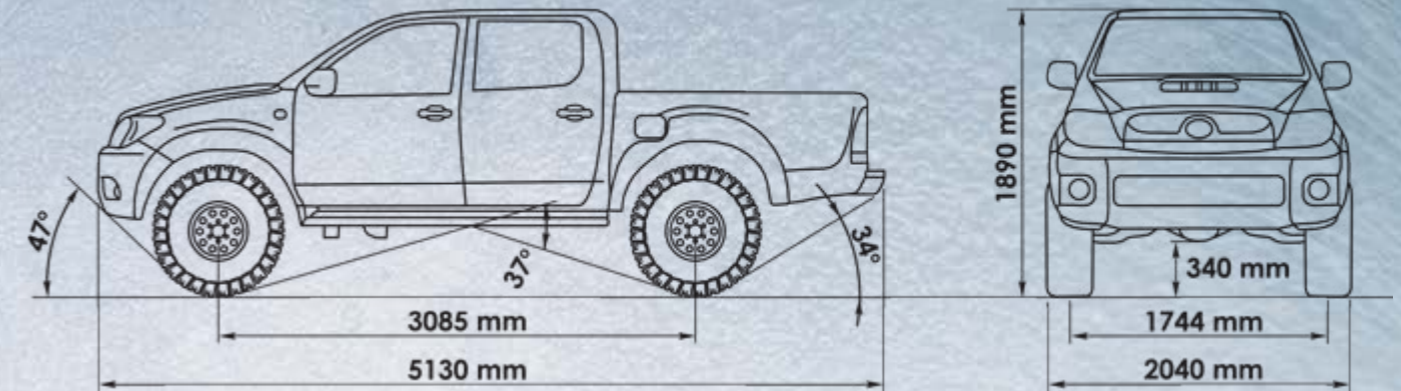

Choose your suspension

Choose your tyres



OE suspension (stock)



OME BP-51 suspension



BF Goodrich A/T KO2 315/70 R17

Nokian Hakkapeliitta LT 2 315/70 R17

Modification cost with OE suspension: 8 950 euro net
Delivery to our location not included.
Stainless steel products and additional lamps are not included.
Lead time: 10 working days.

Contact:
e-mail: info@arctictrucks.pl
phone: +48 85 711 95 58

TOYOTA HILUX 2015-



POLISHED: DKUN-R1570-00
BLACK: DKUN-R1570-00-B



POLISHED: DKUN-L1570-05



POLISHED: DKUN-R1570-03



POLISHED: DKUN-L1570-08



POLISHED: DKUN-R1570-06



POLISHED: DKUN-L1570-07



POLISHED: DKUN-R1570-04



POLISHED: DKUN-R1570-R



fi 70 POLISHED: DKUN-R1576-PR-01
fi 100 POLISHED: DKUN-R15100-PR-01



BLACK: DKUN-R1570-R-B



fi 70 BLACK: DKUN-R1576-PR-01-B
fi 100 BLACK: DKUN-R15100-PR-01-B



POLISHED: DKUN-R1570-PR-02



POLISHED: DKUN-R1570-PR



BLACK: DKUN-R1570-PR-02-B



BLACK: DKUN-R1570-PR-B

TOYOTA HILUX 2015-



BLACK: DKUN-L1570-05-B



BLACK: DKUN-L1570-08-B



BLACK: DKUN-L1570-07-B



BLACK: DKUN-R1570-03-B



BLACK: DKUN-R1570-06-B



BLACK: DKUN-R1570-04-B



POLISHED: DKUN-R1570-GR
BLACK: DKUN-R1570-GR-B



POLISHED: DKUN-R1576-GR
BLACK: DKUN-R1576-GR-B



POLISHED: DKUN-R1576-2GR
BLACK: DKUN-R1576-2GR-B

TOYOTA HILUX models with new bumper 2018-



POLISHED: DKUN-R1870-04



POLISHED: DKUN-R1570-PR-02



POLISHED fi70: DKUN-R1576-PR-01

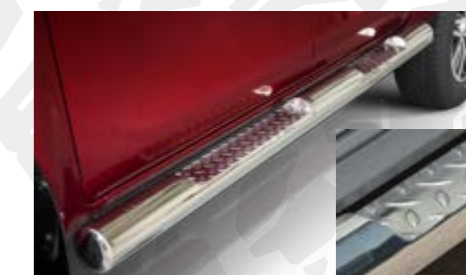

POLISHED fi100: DKUN-R15100-PR-01



POLISHED: DKUN-R1570-PR-05



POLISHED: DKUN-R1570-PR-02

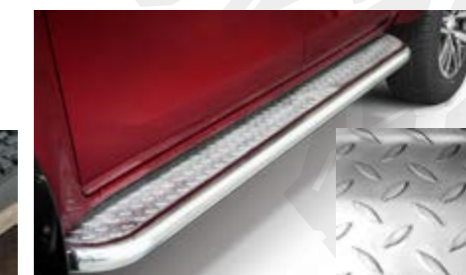

POLISHED: DKUN-R1570-PR

TOYOTA HILUX
models with new bumper
2018-



POLISHED: DKUN-R1870-03



POLISHED: DKUN-L1870-05



BLACK: DKUN-R1870-03-B



BLACK: DKUN-L1870-08-B



POLISHED: DKUN-R1870-00



POLISHED: DKUN-L1870-08



BLACK: DKUN-R1870-00-B



BLACK: DKUN-L1870-05-B



POLISHED fi70: DKUN-R1870-06



POLISHED: DKUN-L1870-07



BLACK: DKUN-R1870-06-B



BLACK: DKUN-L1870-07-B



POLISHED fi76: DKUN-R1876-06



BLACK fi76: DKUN-R1876-06-B



BLACK: DKUN-L1570-08-B



BLACK: DKUN-R1570-PR-02-B



BLACK fi70: DKUN-R1576-PR-01-B



BLACK fi100: DKUN-R15100-PR-01-B



POLISHED: DKUN-R1570-GR
BLACK: DKUN-R1570-GR-B



BLACK: DKUN-R1570-PR-02-B



BLACK: DKUN-R1570-PR-02-B



BLACK: DKUN-R1570-PR-B



POLISHED: DKUN-R1576-GR
BLACK: DKUN-R1576-GR-B



POLISHED: DKUN-R1576-2GR
BLACK: DKUN-R1576-2GR-B

Toyota Hilux / Hilux Revo - AT35



AFTER CONVERSION

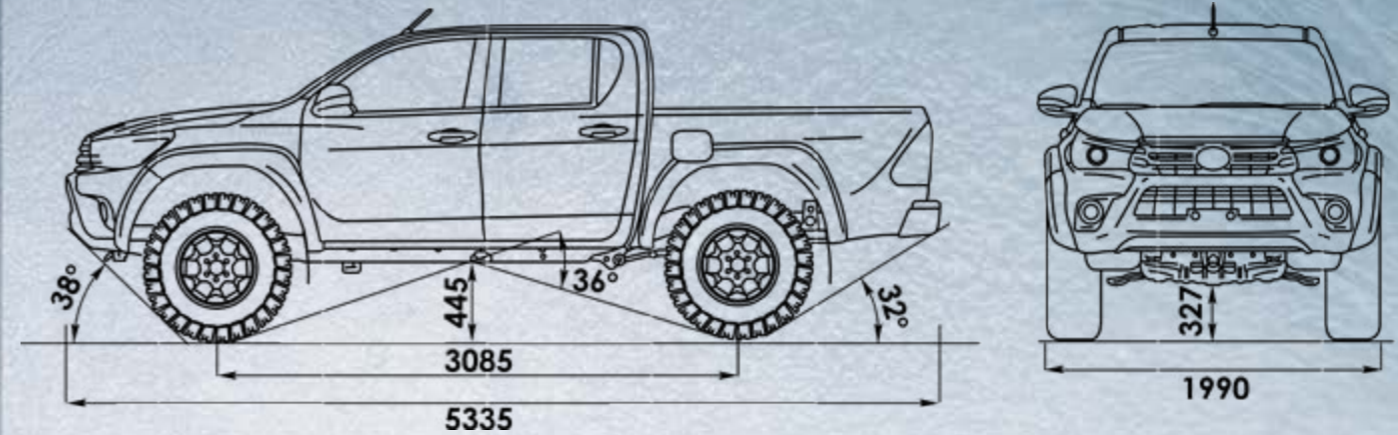

Choose your Suspension

Choose your tyres



OE suspension (stock)

OME BP-51 suspension



BF Goodrich A/T KO2 315/70 R17

Nokian Hakkapeliita LT 2 315/70 R17

When we convert a PICK-UP to 35" tires, we lift the suspension 40 mm, and in some cases we would lift both the suspension and the body. Extra fender flares are used which gives your SUV a powerful look and separates it from all others. With the AT35 you can take your PICK-UP to almost any mountain road in the world, with out having any trouble.

The AT35 will give you much grater ground clearance, better traction, softer ride, higher seating and most of all a feeling of confidence. Also will it give you the possibility to deflate your tires, so that you get a better flotation in snow, sand and mud.

The AT35 is ideal for hunters, farmers and park rangers, or just for those who want something different from the rest.

- 315x70 R17" AT tires
- 17x10" alloy wheels
- Torque wrench
- Fender flares, painted
- Running boards and brackets
- Mud flaps
- Speedometer calibrator
- 40 mm suspension lift, front

Modification cost with OE suspension: 8 950 euro net
 Delivery to our location not included.
 Stainless steel products and additional lamps are not included.
 Lead time: 15 working days.
 Payment: 10% with the order 90% before car pick up.

Contact:
 e-mail: info@arctictrucks.pl
 phone: +48 85 711 95 58

TOYOTA LAND CRUISER 120

2003-2009



POLISHED: DLC120-R0076-06
BLACK: DLC120-R0076-06-B



POLISHED: DLC120-R0076-04
BLACK: DLC120-R0076-04-B



POLISHED: DLC120-R0085-05
BLACK: DLC120-R0085-05-B



POLISHED: DLC120-R0085-03
BLACK: DLC120-R0085-03-B



POLISHED: DLC120-R0085-00
BLACK: DLC120-R0085-00-B



POLISHED: DLC120-R0085-06
BLACK: DLC120-R0085-06-B



POLISHED: DLC120-R0085-BL
BLACK: DLC120-R0085-BL-B



POLISHED: DLC120-R0085-NR
BLACK: DLC120-R0085-NR-B



POLISHED: DLC120-R0085-NR-01
BLACK: DLC120-R0085-NR-01-B

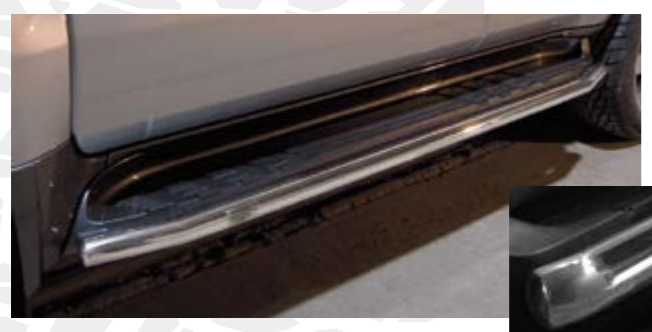

POLISHED: DLC120-R0048-R
BLACK: DLC120-R0048-R-B

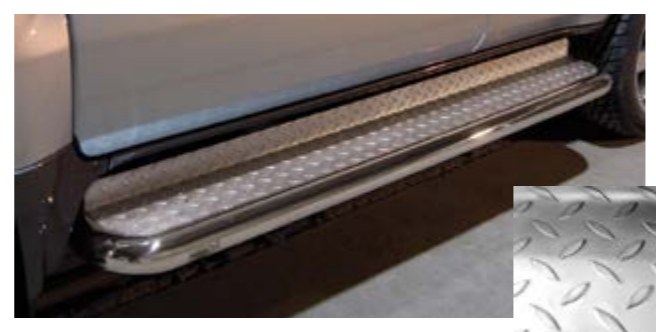

POLISHED: DLC120-R0085-PR
BLACK: DLC120-R0085-PR-B



POLISHED: DLC120-R0085-NR-02
BLACK: DLC120-R0085-NR-02-B

TOYOTA LAND CRUISER 150

2010-2013



POLISHED: DLC150-R0085-00
BLACK: DLC150-R0085-00-B



POLISHED: DLC150-R0076-04
BLACK: DLC150-R0076-04-B



POLISHED: DLC150-R0076-06
BLACK: DLC150-R0076-06-B



POLISHED: DLC150-R0085-03
BLACK: DLC150-R0085-03-B



POLISHED: DLC150-R0085-05
BLACK: DLC150-R0085-05-B



POLISHED: DLC150-R0085-06
BLACK: DLC150-R0085-06-B



POLISHED: DLC150-R0085-BL
BLACK: DLC150-R0085-BL-B



POLISHED: DLC150-R0048-R
BLACK: DLC150-R0048-R-B



POLISHED: DLC150-R0085-PR
BLACK: DLC150-R0085-PR-B



POLISHED: DLC150-R0085-NR
BLACK: DLC150-R0085-NR-B



POLISHED: DLC150-R0085-NR-01
BLACK: DLC150-R0085-NR-01-B

TOYOTA LAND CRUISER 150

2013-2017



POLISHED: DLC150-R1370-00
BLACK: DLC150-R1370-00-B



POLISHED: DLC150-L1370-03
BLACK: DLC150-R1370-03-B



POLISHED: DLC150-L1370-05
BLACK: DLC150-R1370-04-B



POLISHED: DLC150-L1370-05
BLACK: DLC150-L1370-05-B



POLISHED: DLC150-R1370-06
BLACK: DLC150-R1370-06-B



POLISHED: DLC150-L1370-07
BLACK: DLC150-L1370-07-B



POLISHED: DLC150-L1370-08
BLACK: DLC150-L1370-08-B



POLISHED: DLC150-R1348-R
BLACK: DLC150-R1348-R-B



POLISHED: DLC150-R1370-PR
BLACK: DLC150-R1370-PR-B



POLISHED: DLC150-R1370-NR
BLACK: DLC150-R1370-NR-B



POLISHED: DLC150-R1370-NR-01
BLACK: DLC150-R1370-NR-01-B

TOYOTA LAND CRUISER 150 - AT35



AT35 CONVERSION

The Toyota Land Cruiser 150 AT35 is based on the well known and worldwide established Toyota Land Cruiser. In order to fit the larger 315x70 R17 off-road tires the front and rear suspension is lifted 40 mm and the wheel arches are cut up and made larger. Tailor made fender flares are fitted to cover the large tires.

The LC150 modified with 35" tires gives you excellent performance off road but also provides you with an outstanding overview of the traffic in the city. Behind the wheel of this car you have the ability to decide where to go, whether if that is a ride in style in the city or a trip to the roughest outback.

AT35 CONTENTS

- 315x70 R17" tires BFG AT KO2 or Nokian Hakkapeliitta LT2 „Arctic Trucks”
- 17x10" Arctic Trucks alloy wheels
- Torque wrench
- Fender flares, painted
- Running board brackets
- Mud flaps
- Speedometer calibrator
- 40 mm suspension lift, front/rear
- Fender trimming, front/rear
- First aid kit
- Wheel alignment

AFTER CONVERSION

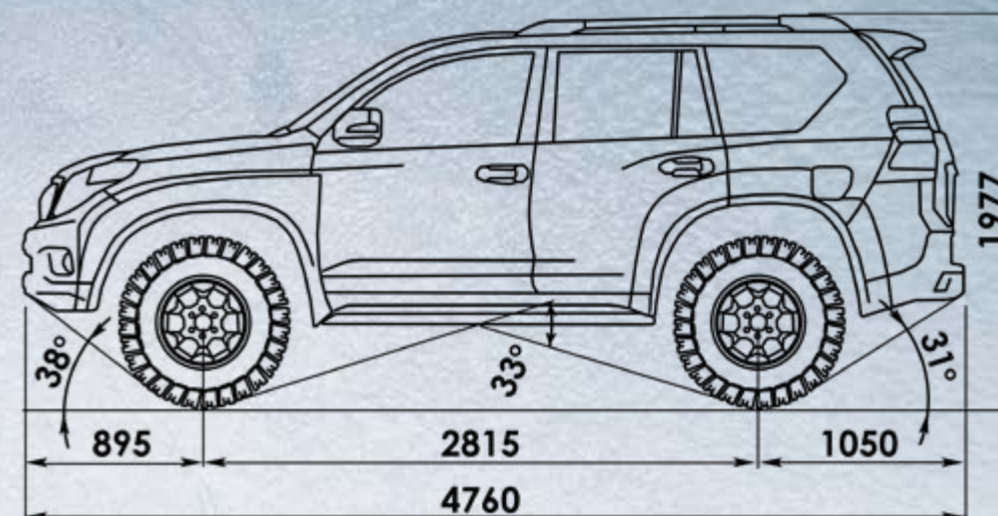

Choose your Suspension

Choose your tyres



OE suspension (stock)

OME BP-51 suspension



BF Goodrich A/T KO2 315/70 R17

Nokian Hakkapeliitta LT 2 315/70 R17

Modification cost with OE suspension: 10 650 euro net
Delivery to our location not included.
Lead time: 14 working days.

Contact:
e-mail: info@arctictrucks.pl
phone: +48 85 711 95 58

TOYOTA LAND CRUISER 150 2017-



POLISHED: DLC150-R1770-04
BLACK: DLC150-R1770-04 -B



POLISHED: DLC150-R1770-03
BLACK: DLC150-R1770-03-B



POLISHED: DLC150-R1770-06
BLACK: DLC150-R1770-06-B



POLISHED: DLC150-R1770-00
BLACK: DLC150-R1770-00 -B



POLISHED: DLC150-L1770-05
BLACK: DLC150-L1770-05-B



POLISHED: DLC150-L1770-07
BLACK: DLC150-L1770-07-B



POLISHED: DLC150-L1770-08
BLACK: DLC150-L1770-08-B



POLISHED: DLC150-R1748-R
BLACK: DLC150-R1748-R-B



POLISHED: DLC150-R1770-PR
BLACK: DLC150-R1770-PR-B



POLISHED: DLC150-R1770-NR
BLACK: DLC150-R1770-NR-B



POLISHED: DLC150-R1770-NR-01
BLACK: DLC150-R1770-NR-01-B

TOYOTA LAND CRUISER V8

R00-(2007-2012) / R12-(2012-2016)



POLISHED: DLCV8-R0085-BL / DLCV8-R1285-BL
BLACK: DLCV8-R0085-BL-B / DLCV8-R1285-BL-B



POLISHED: DLCV8-R0076-04 / DLCV8-R1276-04
BLACK: DLCV8-R0076-04-B / DLCV8-R1276-04-B



POLISHED: DLCV8-R0076-05 / DLCV8-R1276-05
BLACK: DLCV8-R0076-05-B / DLCV8-R1276-05-B



POLISHED: DLCV8-R0076-06 / DLCV8-R1276-06
BLACK: DLCV8-R0076-06-B / DLCV8-R1276-06-B



POLISHED: DLCV8-R0085-00 / DLCV8-R1285-00
BLACK: DLCV8-R0085-00-B / DLCV8-R1285-00-B



POLISHED: DLCV8-R0085-03 / DLCV8-R1285-03
BLACK: DLCV8-R0085-03-B / DLCV8-R1285-03-B



POLISHED: DLCV8-R0085-06 / DLCV8-R1285-06
BLACK: DLCV8-R0085-06-B / DLCV8-R1285-06-B



POLISHED: DLCV8-R0048-R / DLCV8-R1248-R
BLACK: DLCV8-R0048-R-B / DLCV8-R1248-R-B



POLISHED: DLCV8-R0076-PR / DLCV8-R1285-PR
BLACK: DLCV8-R0076-PR-B / DLCV8-R1285-PR-B



POLISHED: DLCV8-R0085-NR-02
BLACK: DLCV8-R0085-NR-02-B



POLISHED: DLCV8-R0085-NR / DLCV8-R1285-NR
BLACK: DLCV8-R0085-NR-B / DLCV8-R1285-NR-B



POLISHED: DLCV8-R0085-NR-01 / DLCV8-R1285-NR-01
BLACK: DLCV8-R0085-NR-01-B / DLCV8-R1285-NR-01-B

TOYOTA LAND CRUISER V8 / LC200 - AT35



AT35 CONVERSION

The LC V8 AT35 is the top of the line in the Arctic Trucks family. The Land Cruiser 200 is fitted with 35" tires and suspension lift. Tailor made fender flares are fitted that will give your car a prestigious yet powerful look. The perfect combination of power and grace.

The LC V8 modified with 35" tires gives you excellent performance off road but also provides you with an outstanding overview of the traffic in the city. Behind the wheel of this car you have the ability to decide where to go, whether if that is a ride in style in the city or a trip to the roughest outback.

This modification is the perfect choice for the urban professional who wants the best of two worlds, urban style and off road. You decide.

AT35 CONTENTS

- 315x70 R17" tires BFG AT KO2 or Nokian Hakkapeliitta LT2 „Arctic Trucks”
- Alloy wheels 17"x10"
- Side steps brackets
- Mud flaps
- Speedometer calibration unit
- Suspension lift
- Cut fenders, front/back
- First aid kit
- Wheel balance
- Torque wrench set

AFTER CONVERSION

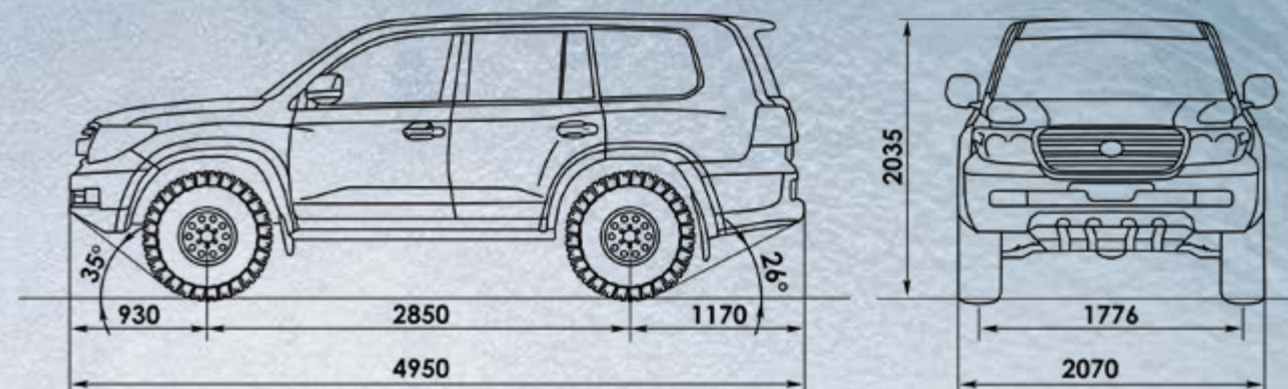

Choose your Suspension

Choose your tyres



OE suspension (stock)

OME BP-51 suspension



BF Goodrich A/T KO2 315/70 R17

Nokian Hakkapeliitta LT 2 315/70 R17

Modification cost with OE suspension: 9 500 euro net
Delivery to our location not included.
Lead time: 10 working days.

Contact:
e-mail: info@arctictrucks.pl
phone: +48 85 711 95 58

TOYOTA PROACE / PROACE VERSO
2016-

TOYOTA RAV4
2006-2010



POLISHED: PROACE-R1660-04 / PROACE-R1660-04-VERSO
BLACK: PROACE-R1660-04 -B / PROACE-R1660-04-VERSO-B

POLISHED: RAV4-R0076
BLACK: RAV4-R0076-B



POLISHED: PROACE-R1660-06 / PROACE-R1660-06-VERSO
BLACK: PROACE-R1660-06 -B / PROACE-R1660-06-VERSO-B

POLISHED: PROACE-R1648-R
BLACK: PROACE-R1648-R-B

POLISHED: RAV4-R0076-R
BLACK: RAV4-R0076-R-B

POLISHED: RAV4-R0076-PR
BLACK: RAV4-R0076-PR-B



POLISHED: PROACE-R1660-03 / PROACE-R1660-03-VERSO
BLACK: PROACE-R1660-03 -B / PROACE-R1660-03-VERSO-B

POLISHED: PROACE-L1660-05 / PROACE-L1660-05-VERSO
BLACK: PROACE-L1660-05 -B / PROACE-L1660-05-VERSO-B

POLISHED: RAV4-R0076-PR-01
BLACK: RAV4-R0076-PR-01-B

POLISHED: RAV4-R0076-PR-02
BLACK: RAV4-R0076-PR-02-B

TOYOTA RAV4
2006-2010



POLISHED: RAV4-R0076-06
BLACK: RAV4-R0076-06-B



POLISHED: RAV4-R0076-03
BLACK: RAV4-R0076-03-B



POLISHED: RAV4-R0076-BL
BLACK: RAV4-R0076-BL-B



POLISHED: RAV4-R0076-05
BLACK: RAV4-R0076-05-B



POLISHED: RAV4-R0076-04
BLACK: RAV4-R0076-04-B



POLISHED: RAV4-R0076-NR
BLACK: RAV4-R0076-NR-B



POLISHED: RAV4-R0076-NR-01
BLACK: RAV4-R0076-NR-01-B

TOYOTA RAV4
2010-2013



POLISHED: RAV4-R1076-00
BLACK: RAV4-R1076-00-B



POLISHED: RAV4-R1076-R
BLACK: RAV4-R1076-R-B



POLISHED: RAV4-R1076-PR
BLACK: RAV4-R1076-PR-B



POLISHED: RAV4-R1076-PR-01
BLACK: RAV4-R1076-PR-01-B



POLISHED: RAV4-R1076-PR-02
BLACK: RAV4-R1076-PR-02-B

TOYOTA RAV4

2010-2013



POLISHED: RAV4-R1076-03
BLACK: RAV4-R1076-03-B



POLISHED: RAV4-R1076-06
BLACK: RAV4-R1076-06-B



POLISHED: RAV4-R1076-BL
BLACK: RAV4-R1076-BL-B



POLISHED: RAV4-L1076-04
BLACK: RAV4-L1076-04-B



POLISHED: RAV4-L1076-05
BLACK: RAV4-L1076-05-B



POLISHED: RAV4-L1076-07
BLACK: RAV4-L1076-07-B



POLISHED: RAV4-R1076-NR
BLACK: RAV4-R1076-NR-B

POLISHED: RAV4-R1076-NR-01
BLACK: RAV4-R1076-NR-01-B

TOYOTA RAV4

2013-2015



POLISHED: RAV4-R1370
BLACK: RAV4-R1370-B



POLISHED: RAV4-R1370-R
BLACK: RAV4-R1370-R-B



POLISHED: RAV4-R1370-PR
BLACK: RAV4-R1370-PR-B



POLISHED: RAV4-R1376-PR-01
BLACK: RAV4-R1376-PR-01-B



POLISHED: RAV4-R1370-PR-02
BLACK: RAV4-R1370-PR-02-B

TOYOTA RAV4
2013-2015



POLISHED: RAV4-R1370-03
BLACK: RAV4-R1370-03-B



POLISHED: RAV4-R1370-04
BLACK: RAV4-R1370-04-B



POLISHED: RAV4-R1370-06
BLACK: RAV4-R1370-06-B



POLISHED: RAV4-R1376-04
BLACK: RAV4-R1376-04-B



POLISHED: RAV4-R1376-05
BLACK: RAV4-R1376-05-B



POLISHED: RAV4-R1376-07
BLACK: RAV4-R1376-07-B

POLISHED: RAV4-R1370-NR
BLACK: RAV4-R1370-NR-B



TOYOTA RAV4
2015-2018



POLISHED: RAV4-R1670-00
BLACK: RAV4-R1670-00-B



POLISHED: RAV4-R1670-NR
BLACK: RAV4-R1670-NR-B



POLISHED: RAV4-R1670-R
BLACK: RAV4-R1670-R-B

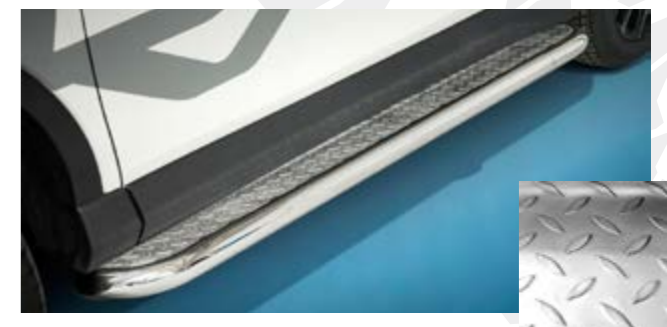

POLISHED: RAV4-R1670-PR
BLACK: RAV4-R1670-PR-B

TOYOTA RAV4
2015-2018



POLISHED: RAV4-R1670-04
BLACK: RAV4-R1670-04-B



POLISHED: RAV4-R1670-03
BLACK: RAV4-R1670-03-B



POLISHED: RAV4-R1670-06
BLACK: RAV4-R1670-06-B



POLISHED: RAV4-L1670-05
BLACK: RAV4-L1670-05-B



POLISHED: RAV4-L1670-08
BLACK: RAV4-L1670-08-B



POLISHED: RAV4-L1670-07
BLACK: RAV4-L1670-07-B



POLISHED: RAV4-R1680-PR-04
BLACK: RAV4-R1680-PR-04-B



POLISHED: RAV4-R1676-PR-01
BLACK: RAV4-R1676-PR-01-B

TOYOTA RAV4
2018-



POLISHED: RAV4-R1870-00
BLACK: RAV4-R1870-00-B



POLISHED: RAV4-R1860-R
BLACK: RAV4-R1670-R-B



POLISHED: RAV4-R1860-PR
BLACK: RAV4-R1860-PR-B



POLISHED: RAV4-R1876-PR-01
BLACK: RAV4-R1876-PR-01-B



POLISHED: RAV4-R1870-PR-02
BLACK: RAV4-R1870-PR-02-B

TOYOTA RAV4
2018-



POLISHED: RAV4-R1870-03
BLACK: RAV4-R1870-03-B



POLISHED: RAV4-R1870-04
BLACK: RAV4-R1870-04-B



POLISHED: RAV4-L1870-07
BLACK: RAV4-L1870-07-B



POLISHED: RAV4-N1860-09
BLACK: RAV4-N1860-09-B



POLISHED: RAV4-R1870-06
BLACK: RAV4-R1870-06-B



POLISHED: RAV4-L1670-05
BLACK: RAV4-L1670-05-B



POLISHED: RAV4-L1870-08
BLACK: RAV4-L1870-08-B

VOLKSWAGEN AMAROK
2009-2016



POLISHED: AMAROK-R0070
BLACK: AMAROK-R0070-B

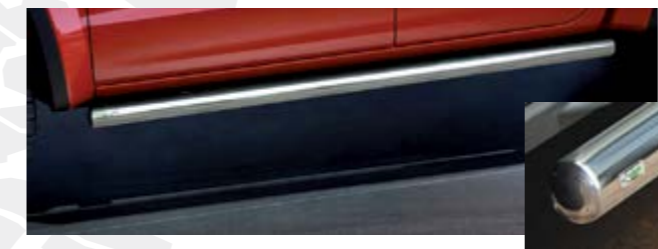

POLISHED: AMAROK-R0070-R
BLACK: AMAROK-R0070-R-B

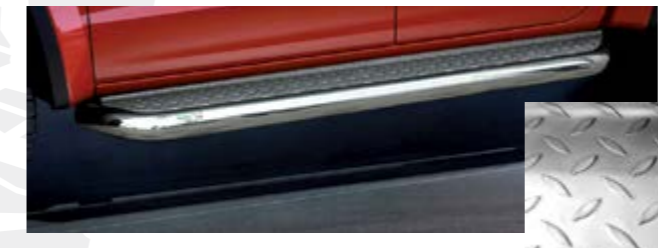

POLISHED: AMAROK-R0070-PR
BLACK: AMAROK-R0070-PR-B

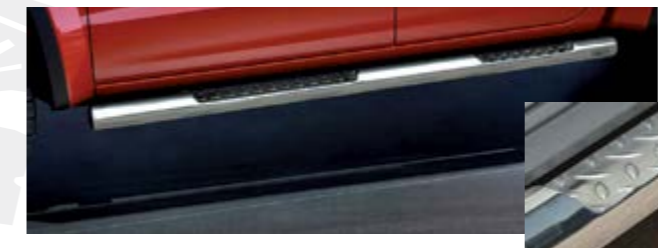

POLISHED: AMAROK-R0076-PR-01
BLACK: AMAROK-R0076-PR-01-B

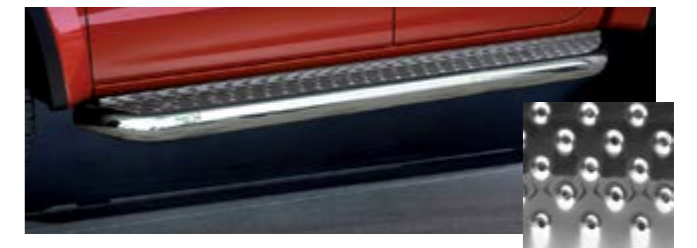

POLISHED: AMAROK-R0070-PR-03
BLACK: AMAROK-R0070-PR-03-B

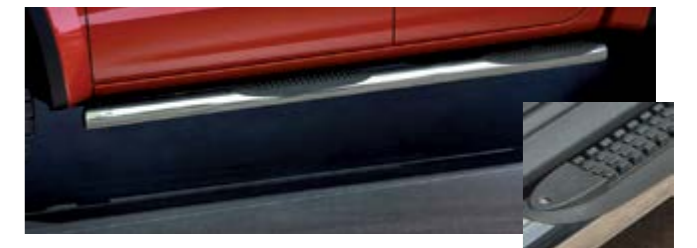

POLISHED: AMAROK-R0070-PR-02
BLACK: AMAROK-R0070-PR-02-B

VOLKSWAGEN AMAROK

2009-2016

VOLKSWAGEN AMAROK V6

2016-



POLISHED: AMAROK-R0070-03
BLACK: AMAROK-R0070-03-B



POLISHED: AMAROK-R0070-04
BLACK: AMAROK-R0070-04-B



POLISHED: AMAROK-R0070-06
BLACK: AMAROK-R0070-06-B



POLISHED: AMAROK-R0076-03 / AMAROK-R0076-03-SKID
BLACK: AMAROK-R0076-03-B / AMAROK-R0076-03-SKID-B



POLISHED: AMAROK-R0076-04 / AMAROK-R0076-04-SKID
BLACK: AMAROK-R0076-04-B / AMAROK-R0076-04-SKID-B



POLISHED: AMAROK-R0076-06 / AMAROK-R0076-06-SKID
BLACK: AMAROK-R0076-06-B / AMAROK-R0076-06-SKID-B



POLISHED: AMAROK-R0076-GR
BLACK: AMAROK-R0076-GR-B



POLISHED: AMAROK-R0076-2GR
BLACK: AMAROK-R0076-2GR-B



POLISHED: AMAROK-R1670-00

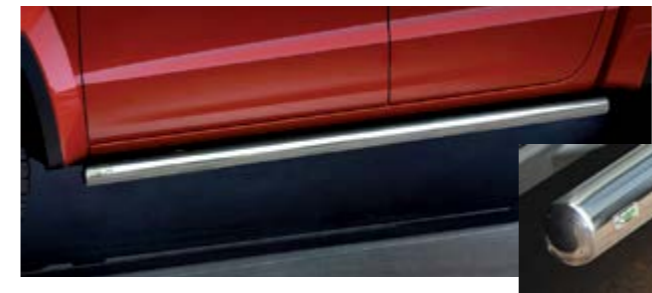

POLISHED: AMAROK-R0070-R

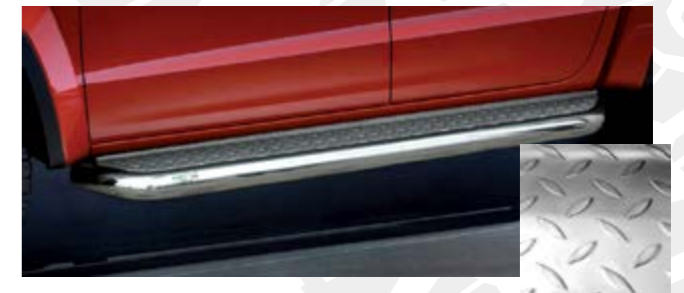

POLISHED: AMAROK-R0070-PR

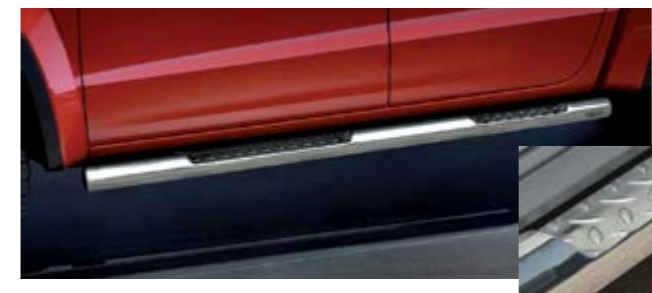

POLISHED: AMAROK-R0076-PR-01

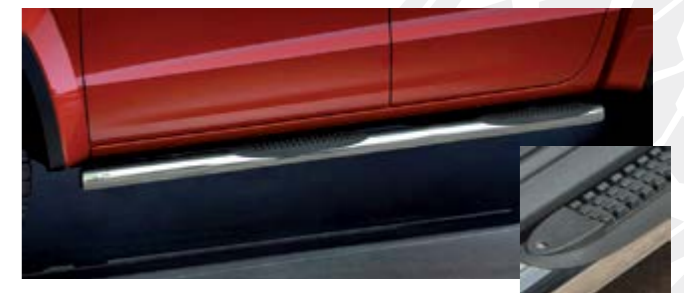

POLISHED: AMAROK-R0070-PR-02

VOLKSWAGEN AMAROK V6 2016-



POLISHED: AMAROK-R1670-06



POLISHED: AMAROK-L1670-05



BLACK: AMAROK-R1670-06-B



BLACK: AMAROK-L1670-05-B



POLISHED: AMAROK-R1670-03



POLISHED: AMAROK-L1670-07



BLACK: AMAROK-R1670-03-B



BLACK: AMAROK-L1670-07-B



POLISHED: AMAROK-R1670-04



POLISHED: AMAROK-L1670-08



BLACK: AMAROK-R1670-04-B



BLACK: AMAROK-L1670-08-B



BLACK: AMAROK-R1670-00-B

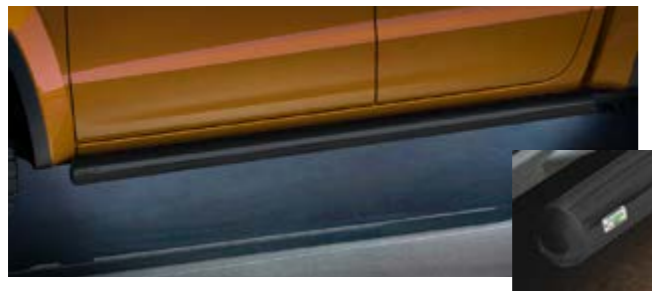

BLACK: AMAROK-R0070-R-B



BLACK: AMAROK-R0070-PR-B

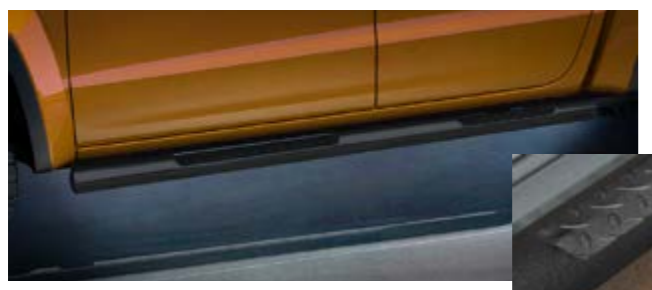

BLACK: AMAROK-R0076-PR-01-B

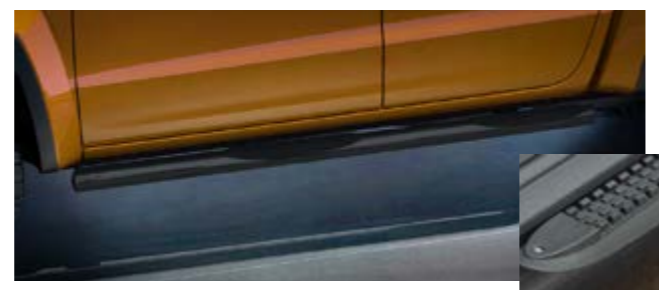

BLACK: AMAROK-R0070-PR-02-B



POLISHED: AMAROK-R0076-GR
BLACK: AMAROK-R0076-GR-B



POLISHED: AMAROK-R0076-2GR
BLACK: AMAROK-R0076-2GR-B

VOLKSWAGEN CADDY

2010-2017

POLISHED: CADDY-R1070
BLACK: CADDY-R1070-B



POLISHED: CADDY-R1070-03
BLACK: CADDY-R1070-03-B



POLISHED: CADDY-R1076-06
BLACK: CADDY-R1076-06-B



POLISHED: CADDY-R1070-04
BLACK: CADDY-R1070-04-B



POLISHED: CADDY-R1060-R / CADDY-R1060-R-MAXI
BLACK: CADDY-R1060-R-B / CADDY-R1060-R-MAXI-B

VOLKSWAGEN CRAFTER

2006-2017



POLISHED: CRAFTER-R0070
BLACK: CRAFTER-R0070-B



POLISHED: CRAFTER-R0070-03
BLACK: CRAFTER-R0070-03-B



POLISHED: CRAFTER-R0070-04
BLACK: CRAFTER-R0070-04-B

VOLKSWAGEN CRAFTER

2017-



POLISHED: CRAF-L1770-08
BLACK: CRAF-L1770-08-B



POLISHED: CRAF-L1770-05
BLACK: CRAF-L1770-05-B



POLISHED: CRAF-R1770-06
BLACK: CRAF-R1770-06-B



POLISHED: CRAF-R1770-03
BLACK: CRAF-R1770-03-B



POLISHED: CRAF-R1770-00
BLACK: CRAF-R1770-00-B



POLISHED: CRAF-R1770-04
BLACK: CRAF-R1770-04-B



POLISHED: CRAF-R1760-R-SWB
BLACK: CRAF-R1760-R-SWB-B

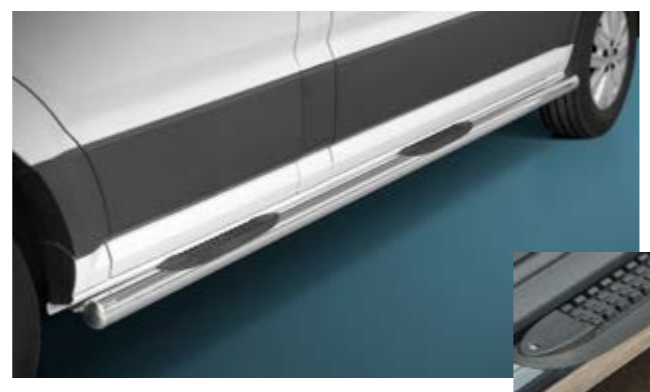

POLISHED: CRAF-R1770-PR-02-SWB
BLACK: CRAF-R1770-PR-02-SWB-B



POLISHED: CRAF-R1776-PR-01-SWB
BLACK: CRAF-R1776-PR-01-SWB-B

VOLKSWAGEN T5
2003-2010-2015



POLISHED: T5-R0070-04
BLACK: T5-R0070-04-B



POLISHED: T5-R0070
BLACK: T5-R0070-B



POLISHED: T5-R0070-03
BLACK: T5-R0070-03-B



POLISHED: T5-R0070-06
BLACK: T5-R0070-06-B



POLISHED: T5-R0076-04
BLACK: T5-R0076-04-B



POLISHED: T5-R0076-06
BLACK: T5-R0076-06-B



POLISHED: T5-R0060-R-SWB / T5-R0060-R-LWB
BLACK: T5-R0060-R-SWB-B / T5-R0060-R-LWB-B



POLISHED: T5-R0070-PR-SWB / T5-R0070-PR-LWB
BLACK: T5-R0070-PR-SWB-B / T5-R0070-PR-LWB-B



POLISHED: T5-R0076-PR-01-SWB / T5-R0076-PR-01-LWB
BLACK: T5-R0076-PR-01-SWB-B / T5-R0076-PR-01-LWB-B



POLISHED: T5-R0070-PR-02-SWB-B / T5-R0070-PR-02-LWB-B
BLACK: T5-R0070-PR-02-SWB / T5-R0070-PR-02-LWB

VOLKSWAGEN T6
2015-



POLISHED: T6-L1570-08
BLACK: T6-L1570-08-B



POLISHED: T6-L1570-05
BLACK: T6-L1570-05-B



POLISHED: T6-R1570-03
BLACK: T6-R1570-03-B



POLISHED: T6-R1570-04
BLACK: T6-R1570-04 -B



POLISHED: T6-R1570-00
BLACK: T6-R1570-00-B



POLISHED: T6-R1570-06V2
BLACK: T6-R1570-06V2-B



POLISHED: T6-R1560-R-SWB
BLACK: T6-R1560-R-SWB-B



POLISHED: T6-R1570-PR-02-SWB/LWB
BLACK: T6-R1570-PR-02-SWB-B/LWB-B

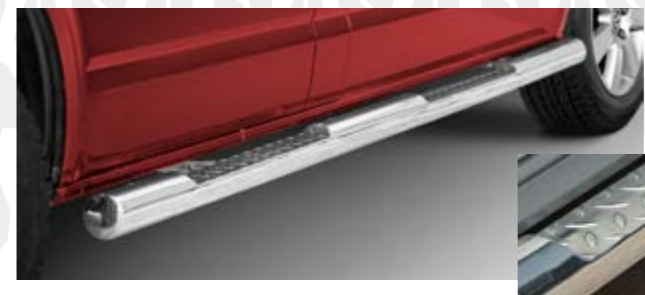

POLISHED: T6-R1576-PR-01-SWB-B/LWB-B
BLACK: T6-R1576-PR-01-SWB-B/LWB-B

VOLKSWAGEN TIGUAN

2007-2011-2015



POLISHED: TIGUAN-R0070-00
BLACK: TIGUAN-R0070-00-B



POLISHED: TIGUAN-R0070-04
BLACK: TIGUAN-R0070-04-B



POLISHED: TIGUAN-R0070-03
BLACK: TIGUAN-R0070-03-B



POLISHED: TIGUAN-R0076-04
BLACK: TIGUAN-R0076-04-B



POLISHED: TIGUAN-R0070-06
BLACK: TIGUAN-R0070-06-B



POLISHED: TIGUAN-R0076-06
BLACK: TIGUAN-R0076-06-B



POLISHED: TIGUAN-R0060-R
BLACK: TIGUAN-R0060-R-B



POLISHED: TIGUAN-R0070-PR
BLACK: TIGUAN-R0070-PR-B



POLISHED: TIGUAN-R0076-PR-01
BLACK: TIGUAN-R0076-PR-01-B



POLISHED: TIGUAN-R0070-PR-02
BLACK: TIGUAN-R0070-PR-02-B

POLISHED: TIGUAN-R0076-NR
BLACK: TIGUAN-R0076-NR-B



VOLKSWAGEN TOUREG

2011-2015



POLISHED: TOUAREG-R1170
BLACK: TOUAREG-R1170-B



POLISHED: TOUAREG-R1170-03
BLACK: TOUAREG-R1170-03-B



POLISHED: TOUAREG-R1170-04
BLACK: TOUAREG-R1170-04-B



POLISHED: TOUAREG-R1170-06
BLACK: TOUAREG-R1170-06-B



POLISHED: TOUAREG-R1176-04
BLACK: TOUAREG-R1176-04-B



POLISHED: TOUAREG-R1176-06
BLACK: TOUAREG-R1176-06-B



POLISHED: TOUAREG-R1176-PR-01
BLACK: TOUAREG-R1176-PR-01-B



POLISHED: TOUAREG-R1170-PR-02
BLACK: TOUAREG-R1170-PR-02-B



POLISHED: TOUAREG-R1176-R
BLACK: TOUAREG-R1176-R-B

VOLVO XC60
2014-2017



POLISHED: XC60-N1460-10
BLACK: XC60-N1460-10-B



POLISHED: XC60-N1460-09
BLACK: XC60-N1460-09-B



POLISHED: XC60-L1460-05
BLACK: XC60-L1460-05-B



POLISHED: XC60-R1460-06
BLACK: XC60-R1460-06-B



POLISHED: XC60-L1460-08
BLACK: XC60-L1460-08-B



POLISHED: XC60-R1460-03
BLACK: XC60-R1460-03-B



POLISHED: XC60-R1460-04
BLACK: XC60-R1460-04-B



POLISHED: XC60-R1460-R
BLACK: XC60-R1460-R-B



POLISHED: XC60-R1476-PR-01
BLACK: XC60-R1476-PR-01-B



POLISHED: XC60-R1470-PR-02
BLACK: XC60-R1470-PR-02-B



POLISHED: XC60-R1460-00
BLACK: XC60-R1460-00-B

4X4 & PICK-UP ACCESSORIES

ALL STAINLESS STEEL BARS
ALSO AVAILABLE IN **BLACK**



Mountain Top roll-covers



Mountain Top aluminium cover



Over & under rail bedliners



Tonneau covers



Aeroklas canopies



Alpha SCZ canopies

Hardtops
and tonneau covers for:

- Fiat Fullback
- Ford Ranger
- Isuzu D-MAX
- Mitsubishi L200
- Nissan Navara
- Nissan NP300
- Toyota Hilux
- Volkswagen Amarok
- X-Class



TYPE E Series



CHECK OUR QUALITY IN **DETAILS**

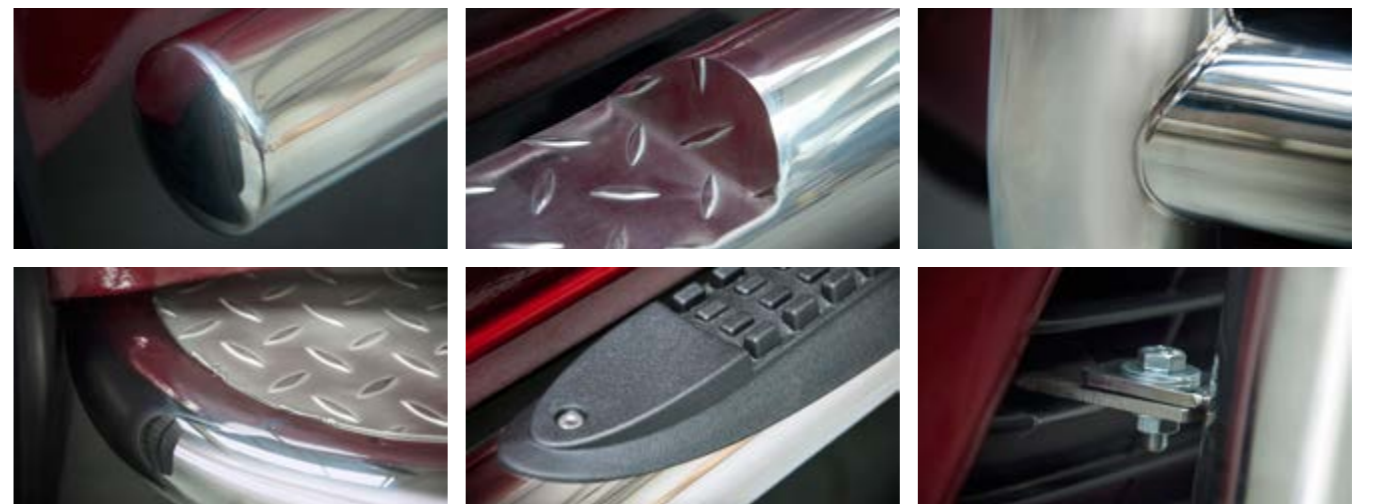

UPGRADE YOUR BARS WITH HELLA & LAZER LIGHTS



UTILITY HARDTOPS FOR PROFESSIONALS



UTILITY HARDTOPS FOR PROFESSIONALS

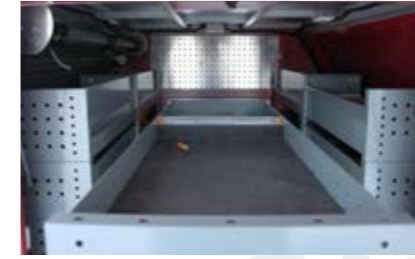



STEELER
ul. Grodzińska 206
16-100 Sokolka
Poland
info@steeler.pl
website: www.steeler.pl
e-shop: www.steeler4x4.com
tel.: 85 711 95 58
fax: 85 711 95 59

STEELEER® 2019 www.steelers.com • www.steelers4x4.com