



FEI juhised varustuse ja riietuse kasutamiseks koolisõidus







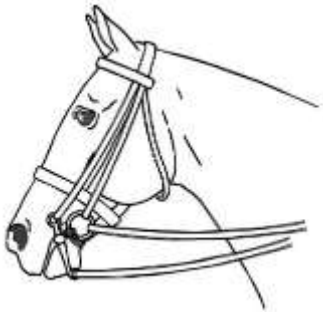



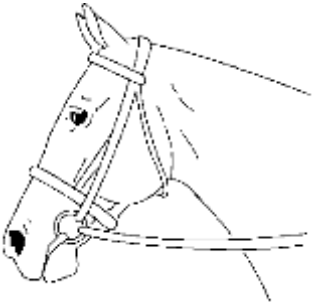

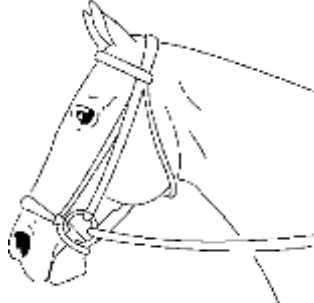

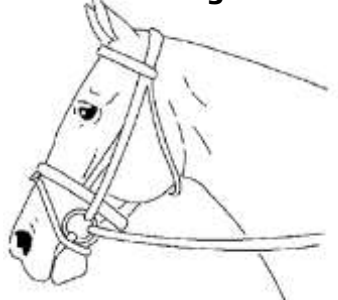
Seda dokumenti tuleb lugeda koos [FEI koolisõidu määrustiku](#) ning [ERL koolisõidu määrustiku](#) kehtivate versioonidega. Erinevuste korral kehtib ERL võistlustel ERL koolisõidumäärustik.



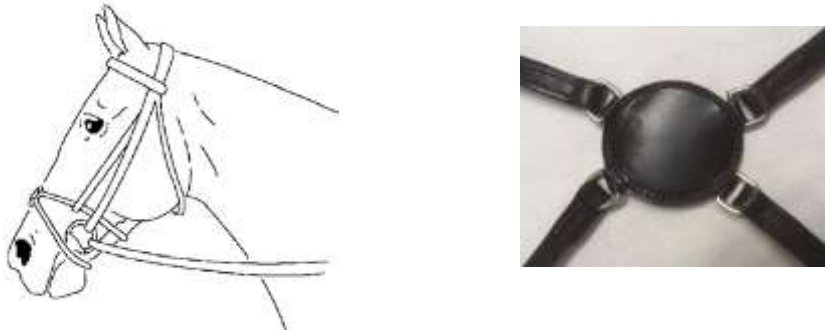

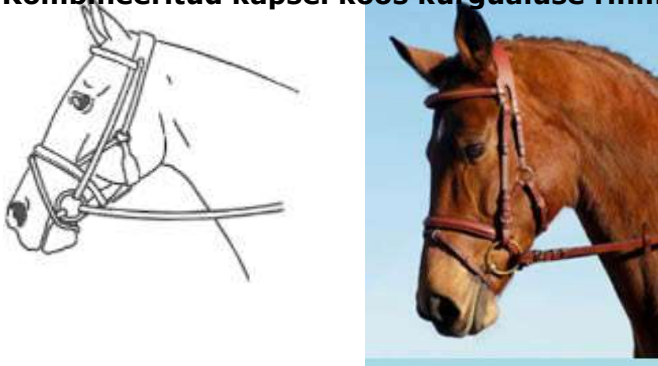

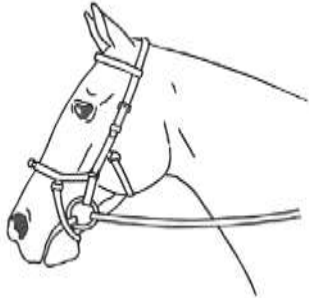
Sisukord







Valjad / Kapslid / Ratsmed	3
Suulised	17
Kõrvakatted ja putukamaskid	35
Sadul ja jalused.....	38
Kannused.....	41
Muu.....	44







Teema	Lubatud või mitte	
<h2>Valjad / Kapslid / Ratsmed</h2>		
<p>Kõik mainitud varustuse osad peavad olema lubatud FEI KSM art 431 and 434 ja ERL KSM Art. 5.2</p>		
<p>Suulised tohivad olla kinnitatud ainult ratsmete ja põserihmade külge.</p>		
<p>Kapsli kontroll:</p> <p>FEI Dressage Rules art 434.2.1.5 / ERL KSM art 6.2</p> <p>Kõikidel koolisõidu raskusastmetel toimuvatel võistlustel ei tohi kapsel olla nii pingul, et see võiks hobusele kahju teha. Kapsleid tuleb kontrollida vastavalt korrapidajate manuaalis toodud protokollile. Korduva rikkumise korral võidakse ratsanikule määrata Kollane Hoiatuskaart korrapidaja korralduste eiramise eest.</p> <p>FEI Stewards Manual dressage Annex IX</p> <p>Kui korrapidaja on soojenduse ajal tuvastatud liiga pingul kapsli, siis on korrapidajatel õigus kontrollida sama hobust ka edasisel soojendusel ning kui kapsel on liiga pingul, peab korrapidaja võistlejal paluma see lõdvemaks panna. Sama korrapidaja peab kontrollima kapslit ka pärast võistlussoorituse lõpetamist. Kui kapsel on ikka liiga pingul, määrab korrapidaja võistlejale Kollase Hoiatuskaardi.</p>		
<div style="display: flex; justify-content: space-around;">   </div> <p>Double Bridle - Kangvaljastus</p>	<p>Kangvaljastuses kasutatakse inglise kapslit, alussuulisi, kangsuulisi ning kangiketti.</p> <p>Dressage Rules Art 434.2.2</p> <p>ERL KSM art. 6:</p> <p>VALJASTUSE KASUTAMNE VÕISTLUSTEL</p>	<p>Lubatud</p> <div style="text-align: center;">  </div> <p>olenevalt võistlusest ja raskusastmest</p>

<p>Snaffle Bridle (with Cavesson noseband) - Trenselvaljastus inglise kapsliga</p> 	<p>Dressage Rules art. 434.2.2</p> <p>ERL KSM art. 6:</p> <p>VALJASTUSE KASUTAMNE VÖISTLUSTEL</p>	<p>Lubatud</p> <p>Olenevalt võistlusest ja raskusastmest</p> 
<p>Dropped Noseband - Hannoveri kapsel</p> 	<p>Lubatud koos trenselvaljastusega</p> <p>Dressage Rules art. 434.2.2.3</p> <p>ERL KSM Art. 5.2.3</p>	<p>Lubatud</p> 
<p>Flash Strap - Ristkapsel ninarihmaga</p>  	<p>Lubatud koos trenselvaljastusega</p> <p>Dressage Rules art. 434.2.2.3</p> <p>ERL KSM Art. 5.2.3</p>	<p>Lubatud</p> 



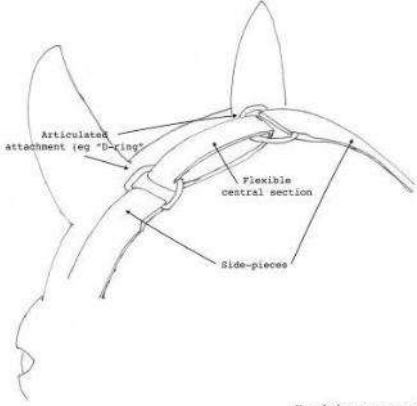

<p>Crossed/Mexican/Grackle Noseband - Mehhiko kapsel</p> 	<p>Lubatud koos trenselvaljastusega</p> <p>Dressage Rules art. 434.2.2.3</p> <p>ERL KSM Art. 5.2.3</p>	<p>Lubatud</p> 
<p>Combined Noseband - Kombineeritud kapsel koos kurgualuse rihmaga</p> 	<p>Lubatud koos trenselvaljastusega</p> <p>Dressage Rules art. 434.2.2.3</p> <p>ERL KSM Art. 5.2.3</p>	<p>Lubatud</p> 
<p>Micklem Style Bridle - Micklem tüüpi valjastus</p> 	<p>Lubatud koos trenselvaljastusega</p> <p>Micklem tüüpi vajastuse puhul pea korrapidaja hindama, kas kapsli ülemine rihm hoiab valjaid piisavalt kindlalt paigal ning toimib kurgualuse rihmana.</p> <p>Dressage Rules art. 434.2.2.3</p> <p>ERL KSM Art. 5.2.3</p>	<p>Lubatud</p> 



<p>Micklem Style Bridle - Micklem tüüpi valjad</p> 	<p>Korrektse sobitatuse korral toimib ülemine rihtm kurgualuse rihtmana.</p> <p>Lubatud koos trenselvaljastusega.</p> <p>Dressage Rules art. 434.2.2.3</p> <p>ERL KSM Art. 5.2.3</p>	<p>Lubatud</p> 
<p>Micklem Style Bridle - Micklem tüüpi valjad</p> 	<p>Ülemine rihtm on liiga madalal, et toimida kurgualuse rihtmana.</p> <p>Dressage Rules art. 434.2.1.3</p> <p>ERL KSM Art. 5.2.3</p>	<p>Ei ole lubatud</p> 
<p>Micklem Bridle with clips – Micklem tüüpi valjad klambritega</p> 	<p>Klambrite kasutamine Micklem tüüpi valjaste EI OLE LUBATUD, seda peetakse abivahendiks.</p> <p>Dressage Rules art 434.5</p> <p>ERL KSM Art. 5.2.1</p>	<p>Ei ole lubatud</p> 

<p>High Jump bridle</p> 	<p>Lubatud variatsioon Micklem tüüpi valjastest</p> <p>Lubatud trenselvaljastusega</p> <p>Dressage Rules art. 434.2.2.3</p> <p>ERL KSM Art. 5.2.3</p>	<p>Lubatud</p> 
<p>Monarch Bridle</p> 	<p>Lubatud variatsioon Micklem tüüpi valjastest</p> <p>Lubatud trenselvaljastusega</p> <p>Dressage Rules art. 434.2.2.3</p> <p>ERL KSM Art. 5.2.3</p>	<p>Lubatud</p> 
<p>Variation of Micklem without a complete noseband - Micklem valjad ilma täieliku kapslita</p> 	<p>Ei ole lubatud, tegu on küll Micklem tüüpi valjastega, kuid täieliku kapsli puudumise tõttu avaldab see hobusele erinevat mõju.</p> <p>Dressage Rules art. 434.2.2.3</p> <p>ERL KSM Art. 5.2.3</p>	<p>Ei ole lubatud</p> 





<p>Mixed Noseband - Ühendatud kapsel</p> 	<p>Ei ole lubatud, kuna tegu on ühendatud inglise ja hannoveri kapsliga</p> <p>Dressage Rules art. 434.2.2.3</p> <p>ERL KSM Art. 5.2.3</p>	<p>Ei ole lubatud</p> 
<p>Noseband with metal sliding system attached to cheek piece - Metall-liuguriga põserihma külge kinnitatud kapsel</p> 	<p>Valjad ning kapsel peavad olema täielikult nahast või nahataolisest materjalist, v.a. pandlad ning pehmendused.</p> <p>Dressage Rules art 434.2.1</p> <p>ERL KSM Art. 5.2.1</p>	<p>Ei ole lubatud</p> 
<p>Head Piece with flexible central section – Kuklarihm paiduva keskosaga</p>   <p>Headpiece overview - diag A</p>	<p>Dressage Rules art. 434.2.1.2</p> <p>ERL KSM Art. 5.2.1</p>	<p>Lubatud</p> 







<p>Bridle - Valjad</p>  <p>Crown piece may not extend beyond the two arrows</p> 	<p>Lubatud variatsioon kombineeritud valjastest</p> <p>Dressage rules: art. 434.2.1.2</p> <p>ERL KSM Art. 5.2.6</p> <p>Kuklarihm peab asetsema kukla taga. See võib ulatuda ettepoole kukla kohale, kuid kinnitus peab olema sobitatud nii, et see asuks kõrvadest tagapool.</p>	<p>Lubatud</p> 
<p>Adjustable and padded V-headpiece – Reguleeritav ja pehmendustega V-kuklarihm</p> 	<p>Dressage rules: art. 434.2.1.2</p> <p>ERL KSM Art. 5.2.1</p>	<p>Lubatud</p> 

<p>Elastic Insert – Elastikust vahetükid</p>  <p>Elastic Concept for rein and cheek piece by PS of Sweden</p> <p>Here we have attached a durable and strong elastic band that is attached to the leather. The elastic touches NEVER the bit. The elastic helps the bit to be a little bit flexible and more dynamic in the mouth.</p> <p>Elastic is placed up here on the cheek piece and is hidden under the keeper.</p> <p>The bit will only and always be in contact with leather, never anything else.</p> <p>PS of Sweden, 7th of March 2017</p>	<p>Dressage rules: art. 434.2.1</p> <p>ERL KSM Art 5.2.1</p> <p>Elastikust vahetükkide kasutamine on lubatud ainult kuklarihmal ning põserihmadel tingimusel, et taoline materjal pole otseses kontaktis suuliste ega hõbusega.</p>	<p>Lubatud</p> 
<p>Clip instead of buckle / Klamber pandla asemel</p> 	<p>Väikseid klambreid võib kasutada valjastel nagu pandlaid, kuid klamber ei tohi olla kinnitatud suulise külge.</p> <p>Dressage rules art. 434.2.1</p> <p>ERL KSM Art 5.2.1</p>	<p>Lubatud</p> 

<p>Otsmikurihm</p> 	<p>Otsmikurihm on kohustuslik ning välja arvatud selle osad, mis kinnituvad valjaste või kuklarihma külge, ei pea olema nahast või nahataolisest materjalist.</p> <p>Dressage rules art. 434.2.1.1</p> <p>ERL KSM Art 5.2.5</p>	<p>Lubatud</p> 
<p>Bridle with double throatlash - Valjad kahekordse kurgualuse rihmaga</p> 	<p>Ei ole lubatud, kuna ei kuulu lubatud valjaste nimekirja</p> <p>Dressage rules art. 434.2.1.3</p>	<p>Ei ole lubatud</p> 
<p>Blinkers - Silmaklapid</p> 	<p>Silmaklapid, mis piiravad hobuse vaatevälja, ei ole lubatud, kuna neid peetakse abivahendiks.</p> <p>Dressage Rules art 434.5</p> <p>ERL KSM Art. 5.5.1</p>	<p>Ei ole lubatud</p> 

<p>Tongue Strap - keelerihm</p> 	<p>Hobuse keele sidumine suuliste külge või muude abivahendite kasutamine keele kontrollimiseks on keelatud ja karistatav võistlustelt kõrvaldamisega.</p> <p>Dressage rules art. 434.3</p> <p>ERL KSM Art 5.3.6</p>	<p>Ei ole lubatud</p> 
<p>Leather or leather-like reins - Nahast või nahataolisest materjalist ratsmed</p> 	<p>Ratsmed ei tohi olla valmistatud nõõrist või nõõritaolisest materjalist.</p> <p>Dressage Rules art 434.2.1.4</p> <p>ERL KSM Art 5.2.8</p>	<p>Lubatud</p> 
<p>Nylon, Cotton, Synthetic material reins - Nailonist, puuvillast ning sünteetilisest materjalist ratsmed</p> 	<p>Ratsmed ei tohi olla valmistatud nõõrist või nõõritaolisest materjalist.</p> <p>Dressage Rules art 434.2.1.4</p> <p>ERL KSM Art 5.2.8</p>	<p>Lubatud</p> 

<p>Rubber Reins – Kummist ratsmed</p> 	<p>Ratsmed ei tohi olla valmistatud nõõrist või nõõritaolisest materjalist.</p> <p>Dressage Rules art 434.2.1.4</p> <p>ERL KSM Art 5.2.8</p>	<p>Lubatud</p> 
<p>Elastic Inserts – Elastikust vahetükid</p> 	<p>Elastikust kinnitused või vahetükid ei ole lubatud.</p> <p>Dressage Rules art 434.2.1.4</p> <p>ERL KSM Art 5.2.8</p>	<p>Ei ole lubatud</p> 

<p>Laced or notched reins – Punatud ja nahkstopperitega ratsmed</p> 	<p>Ratsmed ei tohi olla valmistatud nõõrist või nõõritaolisest materjalist.</p> <p>Dressage Rules art 434.2.1.4</p> <p>ERL KSM Art 5.2.8</p>	<p>Lubatud</p> 
<p>Reins with hand stoppers – ratsmed käetõkistega</p> 	<p>Igasugused suured käetõkised on keelatud, kuna neid peetakse abivahenditeks.</p> <p>Dressage Rules art 434.2.1.4</p> <p>ERL KSM Art. 5.5.1</p>	<p>Ei ole lubatud</p> 
<p>Rope Reins – Nõõrist ratsmed</p> 	<p>Ratsmed ei tohi olla valmistatud nõõrist või nõõritaolisest materjalist.</p> <p>Dressage Rules art 434.2.1.4</p> <p>ERL KSM Art 5.2.8</p>	<p>Ei ole lubatud</p> 

Rein Attachments - Lisakinnitustega ratsmed



Dressage Rules art 434.2.1.4

ERL KSM Art. 5.2.8

Ratse on pidev ja katkematu rihm või lint, mis kulgeb valjaste külge kinnitatud suulistest ratsaniku kätte. Ratsmete külge pole lubatud midagi kinnitada. Iga suuline peab olema ühendatud eraldi ratsmega. Ratsmed peavad olema kinnitatud suuliste külge.

Ei ole lubatud



Suulised

- SUULISTE MÕÕTMED

Suuliste läbimäätu määratakse suuliste rõnga või põseosa juurest. (Dressage Rules art 434.3, ERL KSM Art. 5.3.2)

Kangsuuline – min diameeter 12 mm

Alussuulised – min diameeter 10 mm









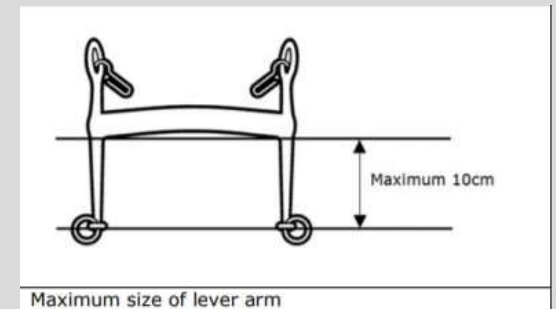

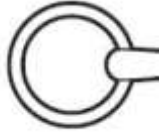
Trenselsuulised – min diameeter 12 mm hobustele ja 10 mm ponidele





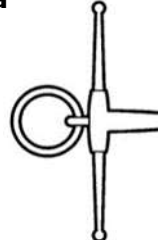



NB! Diameetrit tuleks varustuse kontrollis mõõta vaid kahtluse korral

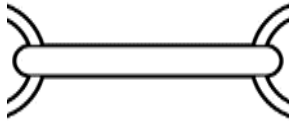
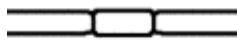



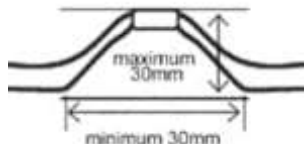
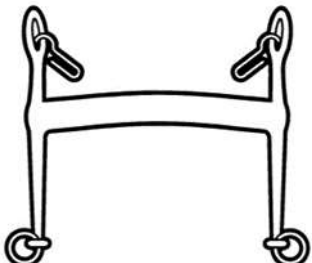
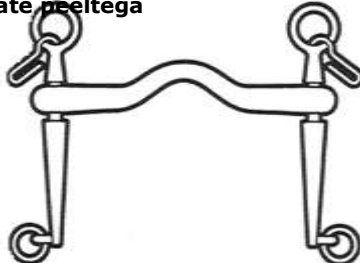

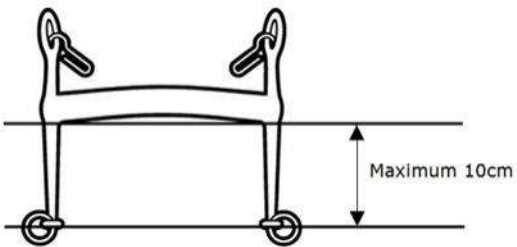
- Kangsuuliste kangiosa e. alumised peeled (Dressage Rules art 434.3.3.1, ERL KSM Art. 5.3.2)

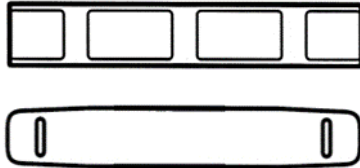







Maksimaalne pikkus 10 cm. Ülemised peeled ei tohi olla pikemad alumistest. Kui kangsuulistel on liikuv suuosa, siis on peelte maksimaalne pikkus 10 cm mõõdetuna suuosa kõige ülemisest asendist.















Lubatud rõngad e. põseosa (Trensel- ja kangsuulsed) NÄIDISED		
<p>Example of Loose Ring – Liikuv rõngas</p> 	<p>Example of Eggbutt - Oliivrõngas</p> 	<p>Example of D-Ring - D-rõngas</p> 
<p>Example of Upper Cheek - Ülemise põsehaaraga rõngas</p> 	<p>Example of Full Cheeks - Põsehaaradega rõngas</p> 	<p>Example of Hanging Cheek - Peeltega rõngas e. Baucher</p> 
<p>Example of Fulmer cheek - Liikuv rõngas põsehaaradega</p> 		
Permitted Mouthpieces		
<p>Example of a single jointed mouthpiece - Ühe liigendiga suuosa</p> 	<p>Example of a double jointed mouthpiece - Kahe liigendiga suuosa</p> 	<p>Example of a double jointed mouthpiece - Kahe liigendiga suuosa</p> 

<p>Example of unjointed mouthpiece - Sirge e. liigendita suusa</p> 	<p>Example of a barrel joint - Silindrikujulise vahelüliga suusa</p> 	<p>Example of a ball joint - Ümmarguse vahelüliga suusa</p> 
<p>Example of double ball joint - Kahe ümmarguse vahelüliga suusa</p> 	<p>Example of a centre piece with a roller - Rullikujulise vahelüliga suusa</p> 	<p>Port deviation measurements (snaffles and curbs) - Maksimaalselt lubatud keeleava mõõdud</p> 
<p>Lubatud kangsuulised</p>		
<p>Curb with straight cheeks - Sirgete peeltega</p> 	<p>Curb with port and sliding mouthpiece (with rotating arms) - Keeleava, liikuva suusa ning pöörduvate peeltega</p> 	<p>Example of a Curb with S cheeks - S-kujuliste peeltega</p> 
	<p>Example of Curb Chain - Kangikett</p> 	<p>Examples of Curb Chain Covers - Kangiketite kate</p> 







<p>Hanging cheeks – Peeltega rõngas</p> 	<p>Lubatud trenselvaljastusega</p> <p>Dressage rules art. 434.3.1.1</p> <p>ERL KSM Art. 5.3.4</p>	<p>Lubatud</p> 
<p>Hanging cheek with cheek piece attached to the mouthpiece and a loose ring</p> 	<p>Põseosa ei vasta määrustikus kirjeldatule</p> <p>Dressage rules art. 434.3.1.1</p> <p>ERL KSM Art. 5.3.4</p>	<p>Ei ole lubatud</p> 
<p>Small cheeks - Väikesed rõngad</p> 	<p>Trenselsuuliste rõngastele pole määratud miinimum ega maksimum suurust</p> <p>Lubatud trenselvaljastusega</p> <p>Dressage rules art. 434.3.1.1</p> <p>ERL KSM Art. 5.3.4</p>	<p>Lubatud</p> 

<p>Variant of Eggbutt cheeks – Variatsioon Oliivi rõngast</p> 	<p>Lubatud, kui suulise mõju on sama mis tavalisel Oliivi rõngal</p> <p>Dressage rules art. 434.3.1.1</p> <p>ERL KSM Art. 5.3.4</p>	<p>Lubatud</p> 
<p>Bit guards – Suulist piiravad kummiseibid</p> 	<p>Ei ole lubatud abivahendina, kuna võivad varjata veritsuse märke</p> <p>Dressage rules: art. 434.5</p> <p>ERL KSM Art 5.5.1</p>	<p>Ei ole lubatud</p> 
<p>“Golden wing” bits</p>  	<p>Ei ole lubatud, sest “Kuldsed tiivad” toimivad sarnaselt suulist piiravate kummiseibidega, seetõttu peetakse neid abivahenditeks</p> <p>Dressage rules: art. 434.5</p> <p>ERL KSM Art 5.5.1</p>	<p>Ei ole lubatud</p> 
<p>Bit with disc on sides – Suulised kummiketastega</p> 	<p>Ei ole lubatud, sest kummiketad toimivad sarnaselt suulist piiravate kummiseibidega, seetõttu peetakse neid abivahenditeks</p> <p>Dressage rules: art. 434.5</p> <p>ERL KSM Art 5.5.1</p>	<p>Ei ole lubatud</p> 

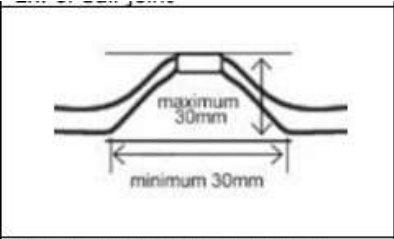



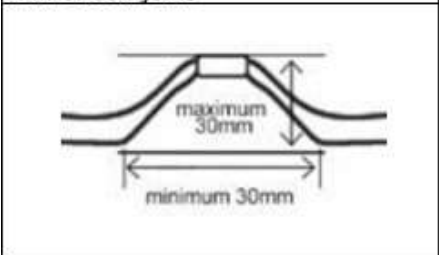



 <p>Full cheek with extra rings – põsehaarade ja lisarõngastega</p>	<p>Ei ole lubatud, sest väikesed rõngad toimivad sarnaselt suulist piiravate kummiseibidega, seetõttu peetakse neid abivahenditeks</p> <p>Dressage rules: art. 434.5</p> <p>ERL KSM Art 5.5.1</p>	<p>Ei ole lubatud</p> 
<p>Loose Ring with sleeve fitted around part of the ring – Osalise kattega liikuv rõngas</p> 	<p>Liikuva rõngaga suulistel võib olla rõnga ümber osaline kate.</p> <p>Dressage Rules art 434.3.1.1</p> <p>ERL KSM Art. 5.3.4</p>	<p>Lubatud</p> 
<p>Hanging Cheek with rotating arms/mouthpiece – Peeltega rõngas pöörduvate peelte ja suosaga</p> 	<p>Ei ole lubatud, kuna erineb peeltega rõnga kirjeldusest määrustikus</p> <p>Dressage Rules art 434.3.1.1</p> <p>ERL KSM Art. 5.3.4</p>	<p>Ei ole lubatud</p> 









<p>Curb with rotating arms around the mouthpiece – Kangsuuline, mille haarad pöörduvad ümber suusa</p> 	<p>Sellised haarad lasevad suusal vabalt suus pöörduda, mis aga pole määrustikus lubatud.</p> <p>Dressage Rules art 434.3.3.1</p> <p>ERL KSM Art 5.3.6</p>	<p>Ei ole lubatud</p> 
<p>Curb with hinged arms – Kangsuuline hingedega peeltega</p> 	<p>Pole lubatud, kuna peelte kirjeldus erineb määrustikus toodust</p> <p>Dressage Rules art 434.3.3.1</p> <p>ERL KSM Art 5.3.6</p>	<p>Ei ole lubatud</p> 
<p>Curb with rotating arms – Kangsuuline pöörduvate peeltega</p> 	<p>Kangsuuline, mille peeled pöörlevad oma telje ümber</p> <p>Dressage Rules art 434.3.3.1</p> <p>ERL KSM Art 5.3.6</p>	<p>Lubatud</p> 





<p>Erinevad rõngad</p> 	<p>Rõngad ei vasta määrustikus toodud kirjeldusele</p> <p>Dressage Rules art 434.3.1.1</p> <p>ERL KSM Art. 5.3.4</p>	<p>Ei ole lubatud</p> 
<p>Ball/barrel joint – Silindrikujuline või ümmargune vahelüli</p> 	<p>Lubatud</p> <p>Dressage rules art. 434.3.1.2/3.2.2</p> <p>ERL KSM Art. 5.3.4</p>	<p>Lubatud</p> 
<p>Center piece with a roller – Rullikujuline vahelüli</p> 	<p>Lubatud</p> <p>Dressage rules art. 434.3.1.2/3.2.2</p> <p>ERL KSM Art 5.3.4</p>	<p>Lubatud</p> 







<p>Snaffle bits with a ported/tilted mouthpiece – Trenselsuulised keeleavaga</p>  <p>Port deviation measurements</p>	<p>Kahe liigendiga või pöörduv suu-osa võib olla kujuga, mis annab keelele ruumi. Maksimaalne lubatud kõrgus keele kõrvalt kuni keeleava kõrgeima punktini on kuni 30 mm. Keeleava kõige laiem osa (minimaalselt 30 mm) peab paiknema seal, kus suulise suu-osa puutub vastu keelt.</p> <p>Dressage rules art 434.3.1.3</p> <p>ERL KSM Art. 5.3.4</p>	<p>Lubatud</p> 
<p>Curb bits with a ported/tilted mouthpiece – Kangsuulised keeleavaga / ettepoole suunatud keeleavaga</p> 	<p>Maksimaalne lubatud kõrgus keele kõrvalt keeleava kõrgeima punktini on kuni 30 mm. Keeleava kõige laiem osa (minimaalselt 30 mm) peab paiknema seal, kus suulise suu-osa puutub vastu keelt. Keeleava võib olla suunatud ettepoole, aga mitte kunagi allapoole.</p> <p>Dressage rules: art. 434.3.3.3</p> <p>ERL KSM Art. 5.3.6</p>	<p>Lubatud</p> 
<p>Curb with downward height deviation – Kangsuuline allapoole suunatud keeleavaga</p>  <p>Port deviation measurements</p> 	<p>Maksimaalne lubatud kõrgus keele kõrvalt keeleava kõrgeima punktini on kuni 30 mm. Keeleava kõige laiem osa (minimaalselt 30 mm) peab paiknema seal, kus suulise suu-osa puutub vastu keelt. Keeleava võib olla suunatud ettepoole, aga mitte kunagi allapoole.</p> <p>Dressage rules art. 434.3.3.3</p> <p>ERL KSM Art. 5.3.6</p>	<p>Ei ole lubatud</p> 







<p>Jointed, rotating mouthpiece on a curb / Liigendiga suuosaga kangsuuline</p> 	<p>Ei ole lubatud</p> <p>Dressage rules: art. 434.3.3</p> <p>ERL KSM Art. 5.3.6</p>	<p>Ei ole lubatud</p> 
<p>Jointed mouthpiece with tilted centre piece / Liigendiga suuosa kallutatud vahelüliga</p> 	<p>Vahelüli võib olla suu-osaga võrreldes kallutatud erinevas suunas, kuid sellel peavad olema ümarad servad ning see ei tohi avaldada keelele allasuruvat efekti.</p> <p>Dressage rules: art. 434.3.1.2</p> <p>ERL KSM Art. 5.3.4</p>	<p>Lubatud</p> 
<p>Double jointed – Kahe liigendiga suuosa</p> 	<p>Lubatud kui kahe liigendiga suuosa, kus vahelüli on ümarate äärtega</p> <p>Dressage rules: art. 434.3.1.2</p> <p>ERL KSM Art. 5.3.4</p>	<p>Lubatud</p> 







<p>Elliptical central joint – Elliptiline vahelüli</p> 	<p>Lubatud kui kahe liigendiga suuosa, kus vahelüli on ümarate äärtega</p> <p>Dressage rules: art. 434.3.1.2</p> <p>ERL KSM Art. 5.3.4</p>	<p>Lubatud</p> 
<p>Cable bits – trossiga ühendatud suulised Trossiga ühendatud kahe liigendiga ja ühe liigendiga suulised</p> 	<p>Trossiga ühendatud ühe või kahe liigendiga suulised pole lubatud, sest nad ei vasta koolisõidumäärustikus toodud kirjeldusele</p> <p>ERL KSM Art. 5.3.4</p>	<p>Ei ole lubatud</p> 
<p>Hybrids bits (I-Bride) as snaffle and bridoon – Hübriidsuulised (I-Bride) trenli ning alussuulistena</p> 	<p>Suulised peavad olema metallist, jäigast plastikust või vastupidavast sünteetilisest materjalist ning võivad olla kaetud kummi või lateksiga.</p> <p>Dressage Rules: art 434.3</p> <p>ERL KSM 5.3.1</p>	<p>Lubatud</p> 
<p>Hybrids bits (I-Bride) as curb - Hübriidsuulised (I-Bride) kangsuulisena</p> 	<p>Suulised peavad olema metallist, jäigast plastikust või vastupidavast sünteetilisest materjalist ning võivad olla kaetud kummi või lateksiga.</p> <p>Dressage Rules: art 434.3</p> <p>ERL KSM 5.3.1</p>	<p>Lubatud</p> 





<p>Lock up joints – Lukustuva liigendiga</p> 	<p>*See suuline on lubatud trenselsuulistena, aga mitte alussuulistena.</p> <p>Lubatud ei ole alussuulised, mille liigend(id) võivad lukustuda ning avaldada liigendita suulise toimet.</p> <p>Dressage rules: art. 434.3.2.3</p> <p>ERL KSM Art. 5.3.4 ja 5.3.5</p>	<p>Lubatud</p> 
<p>Abrupt thin joint – järsu üleminekuga õhuke liigend</p> 	<p>Suuosa liigendil peavad olema ümarad ääred</p> <p>Dressage rules: art. 434.3.1.2</p> <p>ERL KSM Art. 5.3.4</p>	<p>Ei ole lubatud</p> 
<p>Mouthpiece made from synthetic material – Sünteetilisest materjalist suuosa</p> 	<p>Suulised peavad olema metallist, jäigast plastikust või vastupidavast sünteetilisest materjalist</p> <p>Dressage rules: art. 428.3</p> <p>ERL KSM Art. 5.3.1</p>	<p>Lubatud</p> 
<p>Leather mouthpiece – Nahast suuosa</p> 	<p>Suulised peavad olema metallist, jäigast plastikust või vastupidavast sünteetilisest materjalist</p> <p>Dressage rules: art. 428.3</p> <p>ERL KSM Art. 5.3.1</p>	<p>Ei ole lubatud</p> 





<p>Bits with plate as centre link</p> 	<p>Plaadikujulise vahelüliga suulised pole lubatud, kuna ebakorrekse asetose korral avaldab see keelele liigset survet.</p> <p>Vahelüli võib olla kallutatud suuosast erinevas suunas, kuid sellel peavad olema ümarad ning see ei tohi avaldada plaadi kombel keelele allasuruvat efekti.</p> <p>Dressage Rules art 434.3.1.2 ERL KSM Art. 5.3.4</p>	<p>Ei ole lubatud</p> 
<p>Clarification French Link / Dr. Bristol – Selgitus <i>French Link</i> vs. <i>Dr Bristol</i></p> 	<p><i>French Link</i> on lubatud, kuna see on sarnane määrustikus lubatud vahelülile</p> <p><i>Dr. Bristol</i> ei ole lubatud, kuna see on sarnane keelele survet avaldavale plaadile.</p> <p>Dressage Rules art 434.3.1.3 ERL KSM Art. 5.3.4</p>	<p>Vt. Joonis vasakul</p>
<p>Mouthpiece with flat central plate – Suuosa lameda vahelüliga</p> 	<p>Vahelülil peavad olema ümarad ääred</p> <p>Dressage Rules art 434.3.1.2 ERL KSM Art. 5.3.4</p>	<p>Ei ole lubatud</p> 

<p>Rolling part on Mouthpiece – Liikuvad kettad suusal</p> 	<p>Suulised liikuvate ketastega suusal ei ole lubatud, sest liikuv ketas on lubatud ainult suuliste vahelülina. Ülejäänud suuline peab olema "sileda pinnaga".</p> <p>Dressage Rules, art. 434.3 / 3.1.3</p> <p>ERL KSM Art. 5.3.4</p>	<p>Ei ole lubatud</p> 
<p>Mouthpiece with holes – Aukudega suusa</p> 	<p>Suulised peavad olema sileda pinnaga</p> <p>Dressage Rules, art. 434.3</p> <p>ERL KSM Art. 5.3.4</p>	<p>Ei ole lubatud</p> 
<p>Wavy bits – Lainelised suulised</p> 	<p>Lainelised suulised on lubatud, kui nad on sileda pinnaga.</p> <p>Lubatud trenselsuulistena.</p> <p>Dressage Rules, art. 434.3</p> <p>ERL KSM Art. 5.3.4</p>	<p>Lubatud</p> 

<p>Multiple joints – Mitme liigendiga</p> 	<p>Trenselsuuline võib olla kuni kahe liigendiga. Suulised peavad olema sileda pinnaga</p> <p>Dressage Rules, art. 434.3 / 3.1.2</p> <p>ERL KSM Art. 5.3.4</p>	<p>Ei ole lubatud</p> 	
<p>Tongue plate - Keeleplaat</p> 		<p>Ei ole lubatud, kuna suulise keskel on plaat, mis avaldab keelele allasuruvat mõju</p> <p>ERL KSM Art. 5.3.4</p> <p>Dressage Rules art 434.3.1.2 / 3.2.2</p>	<p>Ei ole lubatud</p> 
<p>WTP mouth piece WTP suuosa</p>		<p>Ei ole lubatud, kuna suulise keskel on plaat, mis avaldab keelele allasuruvat mõju</p> <p>ERL KSM Art. 5.3.4</p> <p>Dressage Rules art 434.3.1.2 / 3.2.2</p>	<p>Ei ole lubatud</p> 

<p>Ring bit – Rõngaga suuline</p>		<p>Ei ole lubatud, kuna suuline mis avaldab keelele allasuruvat mõju</p> <p>Dressage Rules art 434.3/ 3.2.2</p> <p>ERL KSM Art. 5.3.4</p>	<p>Ei ole lubatud</p> 
		<p>Ei ole lubatud, kuna suuline mis avaldab keelele allasuruvat mõju</p> <p>Dressage Rules art 434.3/ 3.2.2</p> <p>ERL KSM Art. 5.3.4</p>	<p>Ei ole lubatud</p> 
<p>Additions to bit Lisatud osad</p>		<p>Suulised tohivad olla kaetud kummi või lateksiga</p> <p>Dressage Rules art 434.3</p> <p>ERL KSM Art. 5.3.4</p>	<p>Ei ole lubatud</p> 

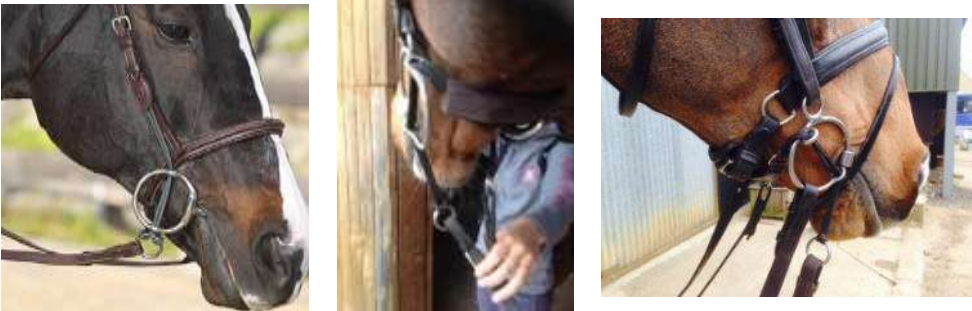
<p>Bit Tape to cover the mouthpiece (latex or rubber) Suuliste katmise teip (lateks või kumm)</p> 	<p>Suulised tohivad olla kaetud kummi või lateksiga</p> <p>Dressage Rules art 434.3</p> <p>ERL KSM Art. 5.3.4</p>	<p>Lubatud</p> 
<p>Bit Tape to create a bit guard Suuliste katmise teip suulist piirava kummiseibina</p> 	<p>Ei ole lubatud, kuna toimib nagu suulist piirav kummiseib (abivahendina)</p> <p>Dressage rules: art. 434.5</p> <p>ERL KSM Art 5.5.1</p>	<p>Ei ole lubatud</p> 
<p>Curb chain clasp – Klambriga kinnitatud kangikett</p> 	<p>Kangiketi konksud võivad olla suletud või avatud.</p> <p>Dressage rules art. 434.3.3.4</p> <p>ERL KSM Art. 5.3.7</p>	<p>Lubatud</p> 

<p>Equismart control</p> 	<p>Ei ole lubatud, kuna peetakse abivahendiks</p> <p>Dressage rules: art. 434.5</p> <p>ERL KSM Art 5.5.1</p>	<p>Ei ole lubatud</p> 
<p>Gags</p> 	<p>Ei ole lubatud, kuna peetakse abivahendiks</p> <p>Dressage rules: art. 434.5</p> <p>ERL KSM Art 5.5.1</p>	<p>Ei ole lubatud</p> 

Kõrvakatted ja putukamaskid

**Ear Hoods –
Kõrvakatted**



Kõrvakatted on lubatud kõikidel võistlustel. Kõrvakatted võivad olla materjalist mis summutab müra. Kõrvakatted peavad olema tagasihoidlikud nii värvilt kui disainilt ning ei tohi katta hobuse silmi ning nende all ei tohi kasutada kõrvatroppe. Kõrvatropid on lubatud ainult hobuste ülevaatusel ja autasustamistel. Kõrvakatted ei tohi olla kinnitatud kapsli külge.

Dressage Rules art 434.6.2

ERL KSM Art. 5.6.3

Lubatud



**Attached Ear Hoods -
Kinnitatud kõrvakatted**









Kõrvakatted ei tohi olla kinnitatud kapsli külge.

Dressage Rules art 434.6.2

ERL KSM Art. 5.6.3

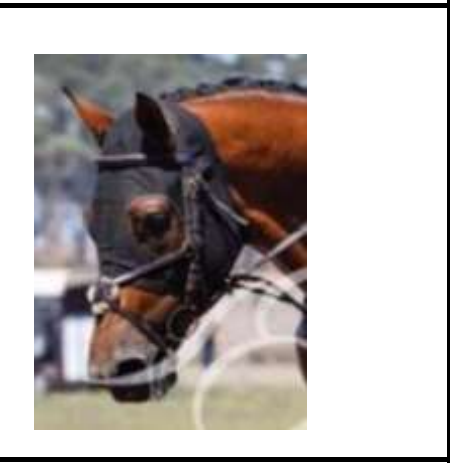
Ei ole lubatud

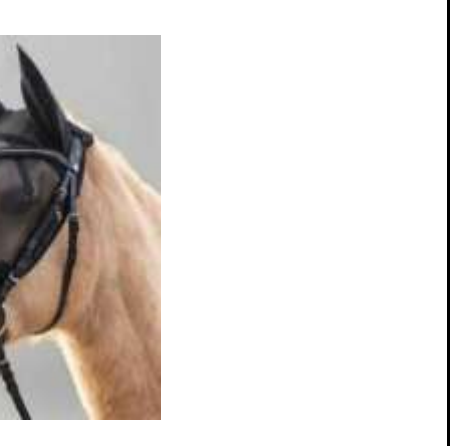

<p>Ear Plugs - Kõrvatropid</p>		<p>Kõrvatropid on lubatud ainult hobuste ülevaatusel ja autasustamistel.</p> <p>Ei ole lubatud võistlussoorituse ajal.</p> <p>Dressage Rules art 434.6.3</p> <p>ERL KSM Art. 5.6.3</p>	<p>Ei ole lubatud</p> <p></p>
<p>Tight fitting head cover – Pea kate</p>		<p>Peetakse abivahendiks</p> <p>Dressage Rules, art. 434.5</p> <p>ERL KSM Art. 5.5.1</p>	<p>Ei ole lubatud</p> <p></p>
<p>Fly Mask – Putukamask</p>		<p>Putukamaskide kasutamine võistlussoorituse ajal on keelatud, kuid see võib olla lubatud soojenduse ja/või treeningute ajal peakorrapidaja ja peakohtuniku eelneval loal.</p> <p>Dressage rules art 434.7</p> <p>ERL KSM Art. 5.6.4</p>	<p>Ei ole lubatud</p> <p></p>

**Fly mask on the nose –
Putukamask ninal**



Putukamaskide kasutamine võistlussoorituse ajal on keelatud, kuid see võib olla lubatud soojenduse ja/või treeningute ajal peakorrapidaja ja peakohtuniku eelneval loal.

Dressage rules art 434.7

ERL KSM Art. 5.6.4

Ei ole lubatud



Sadul ja jalused

Dressage Saddle - Koolisõidusadul

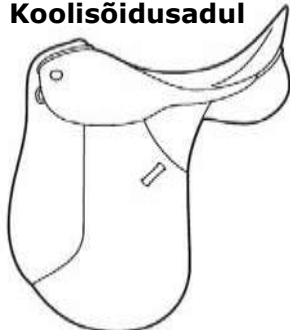

Boot attached to stirrups with hooks – Saabas kinnitatud jaluse külge konksudega



Ratsaniku jalg (saabas) ei tohi olla kinnitatud jaluse külge (näiteks magnetite, konksude vms abil)

Dressage Rules art 434.1.1

ERL KSM Art. 5.1.4

Ei ole lubatud



Magnetic stirrup – Magnetiga jalus



Magnet on jaluse küljes ↑







Ratsaniku jalg (saabas) ei tohi olla kinnitatud jaluse külge (näiteks magnetite, konksude vms abil)

Dressage Rules art 434.1.1

ERL KSM Art. 5.1.4

Ei ole lubatud

















<p>K'Vall Stirrups – K'Vall jalused</p> 	<p>Jalus ei tohi olla eest suletud, seda ei osaliselt ega täielikult.</p> <p>Dressage Rules art 434.1.1</p> <p>ERL KSM Art. 5.1.4</p>	<p>Ei ole lubatud</p> 
<p>Enclosed Stirrups – Eest suletud jalused</p> 	<p>Jalus ei tohi olla eest suletud, seda ei osaliselt ega täielikult.</p> <p>Dressage Rules art 434.1.1</p> <p>ERL KSM Art. 5.1.4</p>	<p>Ei ole lubatud</p> 
<p>Safety Stirrups with open branch on the outside – Turvajalused avatud väljaspoolse haaraga</p> 	<p>Turvajalustel võib väljaspoolne haar olla osaliselt avatud.</p> <p>Dressage Rules art 434.1.1</p> <p>ERL KSM Art. 5.1.4</p>	<p>Lubatud</p> 







<p>Magnetic safety stirrup – Magnetiga turvajalus</p> 	<p>jalg ei tohi olla kinnitatud jaluse külge (näiteks magnetite, konksude vms abil)</p> <p>Dressage Rules art 434.1.1</p> <p>ERL KSM Art. 5.1.4</p>	<p>Ei ole lubatud</p> 
<p>Velcro stirrups – Velcroga jalused</p> 	<p>Ratsaniku jalg (saabas) ei tohi olla kinnitatud jaluse külge (näiteks magnetite, konksude vms abil)</p> <p>Dressage Rules art 434.1.1</p> <p>ERL KSM Art. 5.1.4</p>	<p>Ei ole lubatud</p> 

Kannused

ERL KSM Art. 4.2.1. Kannused on kohustuslikud, välja arvatud laste, poniratsanike, harrastajate ja 4-a / 5-a hobuste arvestuses ning ABC ja ST skeemides. Avatud klassides kehtivad lastele, poniratsanikele, harrastajatele ning noortele hobustele vastava avatud klassi reeglid. Kõikides klassides on lubatud on kasutada imitatsioonkannuseid.

<p>Rowel Spurs with blunt tines – Kettaga kannused tõmpide harudega</p> 	<p>Kui kasutatakse kettaid, siis peavad need olema tõmpide harudega (nn. Daisy-rowel) või siledad (ilma terava ääreta) ning vabalt ringlema.</p> <p>Dressage Rules art 431.4</p> <p>ERL KSM Art. 4.2.2</p>	<p>Lubatud</p> 
<p>Rowels with sharp tines – Kettaga kannused teravate harudega</p> 	<p>Kui kasutatakse kettaid, siis peavad need olema tõmpide harudega (nn. Daisy-rowel) või siledad (ilma terava ääreta) ning vabalt ringlema.</p> <p>Dressage Rules art 431.4</p> <p>ERL KSM Art. 4.2.2</p>	<p>Ei ole lubatud</p> 
<p>Spurs with Rowels – Kettaga kannused</p> 	<p>Kui kasutatakse kettaid, siis peavad need olema tõmpide harudega (nn. Daisy-rowel) või siledad (ilma terava ääreta) ning vabalt ringlema.</p> <p>Dressage Rules art 431.4</p> <p>ERL KSM Art. 4.2.2</p>	<p>Lubatud</p> 

<p>Spurs with horizontal rowels – Kannused horisontaalsete ketastega</p> 	<p>Kui kasutatakse kettaid, siis peavad need olema tšõmpide harudega (nn. Daisy-rowel) või siledad (ilma terava ääreta) ning vabalt ringlema.</p> <p>Dressage Rules art 431.4</p> <p>ERL KSM Art. 4.2.2</p>	<p>Lubatud</p> 
<p>Spur with metal knobs – Kannused metallist nupuga</p> 	<p>Dressage Rules art 431.4</p> <p>ERL KSM Art. 4.2.2</p>	<p>Lubatud</p> 
<p>Spur with plastic knob – Kannused plastikust nupuga</p> 	<p>Dressage Rules art 431.4</p> <p>ERL KSM Art. 4.2.2</p>	<p>Lubatud</p> 
<p>Spurs with flat disk – Kannused fikseeritud lamedate ketastega</p> 	<p>Kui kasutatakse kettaid, siis peavad need olema tšõmpide harudega (nn. Daisy-rowel) või siledad (ilma terava ääreta) ning vabalt ringlema.</p> <p>Dressage Rules art 431.4</p> <p>ERL KSM Art. 4.2.2</p>	<p>Ei ole lubatud</p> 

<p>Swan Neck Spur – Luigekaela kannused</p> 	<p>Kannuse väljaulatuv osa peab olema kas painutatud või sirge ning ratsaniku saapale kinnitades olema suunatud otse tahapoole kannuse keskel.</p> <p>Dressage Rules art 431.4 ERL KSM 4.2.2</p>	<p>Lubatud</p> 
<p>Spurs with extension at the back – Tagumise pikendusega kannused</p>  	<p>Kannused peavad olema tehtud metallist</p> <p>Dressage Rules art 431.4 ERL KSM Art. 4.2.2</p>	<p>Ei ole lubatud</p> 
<p>Dummy Spurs - Imitatsioonkannused</p> 	<p>Imitatsioonkannused ilma väljaulatuva osata on lubatud.</p> <p>Dressage Rules art 431.4 ERL KSM Art. 4.2.2</p>	<p>Lubatud</p> 

Muu

Hoof boots - kabjakaitсед



Kabjakaitсед pole lubatud, sest hobuse jalad ei tohi olla kaetud

Ei ole lubatud



Body bandage (spur pad/protection) – Kehakate (kannusekaitse)







Peetakse abivahendiks

Dressage Rules, art. 434.5

ERL KSM Art. 5.5.1

Ei ole lubatud



<p>Nose Tapes/strips - Ninateip</p>		<p>Peetakse abivahendiks</p> <p>Dressage Rules, art. 434.5</p> <p>ERL KSM Art. 5.5.1</p>	<p>Ei ole lubatud</p> 
<p>Electronic communication device – Elektroonilised kommunikatsioonivahendid</p>		<p>Kõrvaklappide ja kahepoolsete kommunikatsioonivahendite kasutamine ratsanike poolt on võistlussoorituse ajal rangelt keelatud ning karistatav võistlustelt kõrvaldamisega. Soojendusel ja treeningul on kõrvaklapid siiski lubatud.</p> <p>Dressage Rules art. 431.5</p> <p>ERL KSM Art. 4.4</p>	<p>Ei ole lubatud</p> 
<p>Electronic Tracking Device/Data Trackers – Elektroonilised andmekogumisseadmed</p>		<p>Andmekogumisseadmete kasutamine on lubatud, tingimusel et ratsanikul pole neid võistlussoorituse ajal võimalik jälgida ning neil pole mõju varustusele</p> <p>Dressage Rules art 431.5</p> <p>ERL KSM Art. 4.4</p>	<p>Lubatud</p> 