

# BCLAI2(NF/GR)

V.5

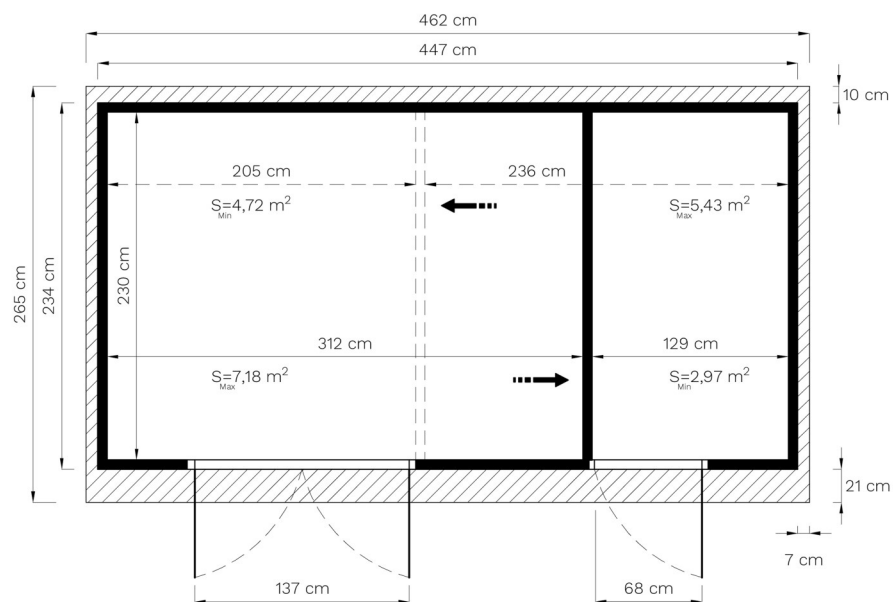
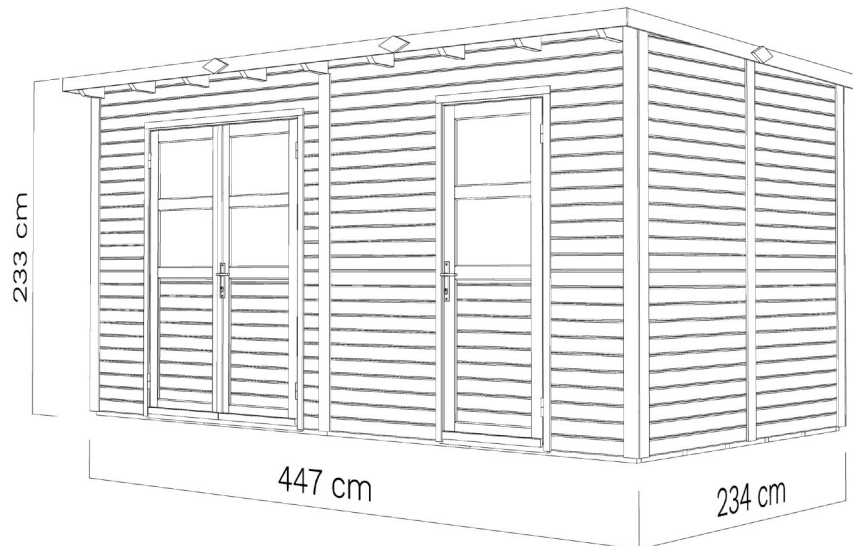

DE - Technische Änderungen vorbehalten.

Alle Maße sind ca. Maße.

EN - Technical modifications reserved.

All dimensions are approximate dimensions.

# BCLAI2(NF/GR)

## DE **Bevor Sie beginnen**

• Es ist empfehlenswert sich etwas Zeit zu nehmen, um die Aufbauanleitung anzusehen, bevor mit dem Aufbau begonnen wird. • Alle Schritte für den Aufbau werden – auch in Detailbildern – dargestellt. • Die vorgegebene Reihenfolge ist zu beachten. • Bitte prüfen Sie vor dem Aufbau anhand der Teileliste die Vollständigkeit und den Zustand der Lieferung. • Besonders wichtig ist der Holzschutz! Die Boden-elemente sind vor dem Aufbau von unten mit einem geeigneten Holzschutz zu behandeln! • Das für die meisten Produkte online verfügbare Datenblatt bietet weitere wichtige Hinweise für den Aufbau. • Beigefügt sind auch die Garantiebedingungen.

## FR **Avant de commencer**

• il est recommandé de prendre le temps de lire les instructions de montage avant de commencer. • Toutes les étapes du montage sont présentées, y compris sur des illustrations détaillées. • L'ordre prescrit doit être respecté. • Avant le montage, vérifiez l'exhaustivité et l'état de la livraison à l'aide de la liste des pièces. • La protection du bois est particulièrement importante! Avant le montage, les éléments de plancher doivent être traités par le bas avec un produit de protection du bois approprié! • La fiche technique disponible en ligne pour la plupart des produits fournit d'autres informations importantes pour le montage. • Les conditions de garantie y sont également jointes.

## CZ **Než začnete**

• Doporučujeme, abyste si vzali trochu času k prohlédnutí montážního návodu, než s montáží začnete. • Všechny montážní kroky jsou zobrazeny - také na podrobných obrázcích. • Je nutné dodržovat uvedený postup. • Před montáží zkontrolujte podle seznamu dílů, zda jste obdrželi všechny díly a zda je dodávka v dobrém stavu. • Obzvláště důležitá je dřevěná botka! Podlahové prvky musí být před montáží zespoda ošetřeny vhodným ochranným přípravkem na dřevo! • Datový list, který je k dispozici online pro většinu produktů, poskytuje další důležité pokyny k montáži. • V příloze naleznete také záruční podmínky.

## DK **Før du starter**

• Det kan anbefales at tage sig tid til at kigge på samlevejledningen, før du starter samlingen. • Alle trin i samlingen bliver vist – også i detaljerede billeder. • Overhold den angivne rækkefølge. • Kontrollér, at leveringen er fuldstændig og i den rette tilstand ved hjælp af delelisten, før du starter samlingen. • Særligt vigtig er træbeskyttelsen! Gulvelementerne skal behandles med egnede træbeskyttelse nedefra, før du starter samlingen! • Til de fleste produkter kan du finde datablade online, der indeholder yderligere vigtige informationer til samlingen. • Garantibetingelserne er også vedlagt.

## NL **Voordat u begint**

• Het is aan te bevelen om de tijd te nemen om de opbouwhandleiding door te nemen voordat er met het opbouwen wordt begonnen. • Alle stappen voor het opbouwen worden - ook met gedetailleerde afbeeldingen - weergegeven. • Neem de aangegeven volgorde in acht. • Controleer voor het opbouwen aan de hand van de onderdelenlijst de volledigheid en de hoedanigheid van de levering. • Bijzonder belangrijk is de bescherming van het hout! De vloerelementen moeten voor het opbouwen van onderen met een geschikt houtbeschermingsmiddel worden behandeld! • Het voor de meeste producten online beschikbare gegevensblad bevat verdere belangrijke aanwijzingen voor de opbouw. • Bijgevoegd zijn ook de

## PL **Przed rozpoczęciem**

• Wskazane jest, aby przed przystąpieniem do montażu zapoznać się z instrukcją montażu. • Pokazane są wszystkie etapy montażu – również na szczegółowych zdjęciach. • Należy przestrzegać podanej kolejności. • Przed montażem należy skorzystać z listy części, aby sprawdzić, czy dostawa jest kompletna i w dobrym stanie. • Ochrona drewna jest szczególnie ważna! Przed montażem elementy podłogowe należy zabezpieczyć od dołu odpowiednim środkiem do konserwacji drewna! • Arkusz danych, który jest dostępny online dla większości produktów, zawiera dalsze ważne informacje dotyczące montażu. • Załączone są również warunki gwarancji.

## SV **Innan du börjar**

• Vi rekommenderar att du åsidosätter lite tid för att titta igenom monteringsanvisningen innan du påbörjar monteringen. • Alla monteringsstegen visas – även med detaljerade bilder. • Den angivna ordningen måste följas. • Kontrollera att leveransen är komplett och i gott skick innan monteringen påbörjas med hjälp av listan över delar. • Träskyddet är av yttersta vikt! Golvelementen ska behandlas underifrån med lämpligt träskyddsmedel före monteringen! • Annan viktig information före montering finns i databladet (tillgängligt online för de flesta produkter). • Garantivillkoren bifogas också.

## RO **Înainte să începeți**

• Vă recomandăm să dedicați puțin timp pentru a consulta Instrucțiunile de asamblare înainte de a începe asamblarea. • Toate etapele de asamblare sunt prezentate amănunțit - și în forma unor figuri detaliate. • Respectați ordinea specificată. • Înainte de asamblare, vă rugăm să verificați lista de componente pentru a vă asigura că furnitura este completă și în stare bună. • Acordați o deosebită atenție protecției lemnului! Elementele de podea trebuie tratate de dedesubt cu o substanță conservantă adecvată pentru protecția lemnului înainte de asamblare! • Fișa de date, care este disponibilă și online pentru majoritatea produselor, oferă informații suplimentare importante cu privire la asamblare. • Atașat veți găsi și condițiile de garanție.











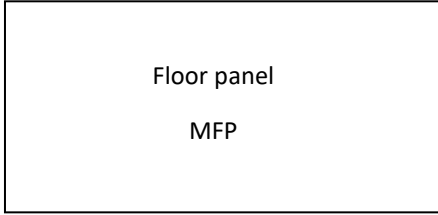
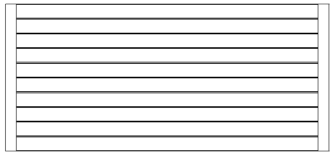
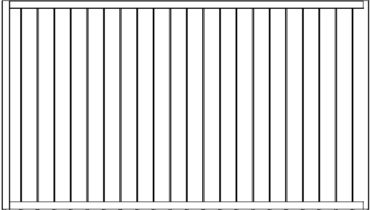
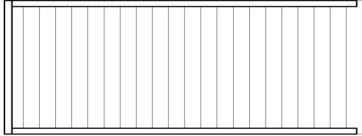



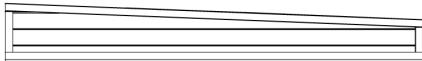
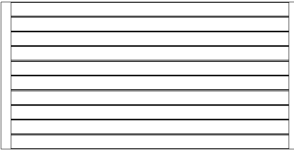
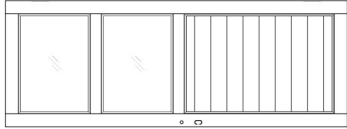



## EE **Soovitused enne paigalduse alustamist**

• Soovitame enne paigalduse alustamist võtta aega ja tutvuda paigaldusjuhendiga. • Kõik kokkupaneku etapid on näidatud ka üksikasjalikel piltidel. • Paigaldustööd tuleks teha etteantud järjekorras. • Enne paigalduse alustamist kontrollige detailide nimekirja alusel, kas kõik elemendid on olemas ja ega need pole kahjustada saanud. • Puidukaitse on eriti oluline! Põrandaelemente tuleb enne kokkupanekut töödelda altpoolt sobiva puidukaitsevahendiga! • Andmeleht, mis on enamiku toodete kohta internetis saadaval, pakub kokkupanekuks täiendavat olulist teavet. • Lisatud on ka garantiitingimused.



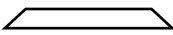















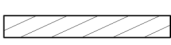
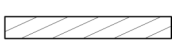
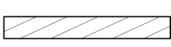



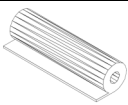

## EN **Before assembly**

• We recommend that time is taken to read the assembly instructions prior to assembly. • All assembly steps are shown – also in detailed images. • The step-by-step instructions must be followed. • Before assembly, please use the parts list to check that all components are accounted for and in good condition. • Wood protection is particularly important! The floor elements must be treated from below with a suitable wood preservative before assembly! • The data sheet, which is available online for most products, offers further important information for assembly. • The guarantee conditions are also attached.

# BCLAI2(NF/GR)

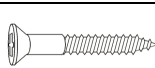
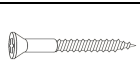
ID	Details in mm (Tolerance/Toleranz ...+ 2mm)	Pcs.	ID	Details in mm (Tolerance/Toleranz ...+ 2mm)	Pcs.
<b>1112</b>	16 x 1109 x 2300  Floor panel MFP	x 4	<b>343</b>	38 x 880 x 1600 	x 6
<b>148</b>	60 x 1109 x 1953 	x 10	<b>149</b>	60 x 554 x 1953 	x 4
<b>163</b>	60 x 311 x 2218 	x 2	<b>153</b>	60 x 224 x 2218 	x 2
<b>165</b>	60 x 311 x 2218 	x 2	<b>164</b>	60 x 311 x 2218 	x 1
<b>342</b>	38 x 880 x 1468 	x 3	<b>40</b>	32 x 690 x 1868 	x 2
<b>39.</b>	32 x 690 x 1868 	x 1	<b>1113</b>	41 x 41 x 2218 	x 14
<b>556</b>	3 x 395 x 550 	x 6	<b>1116</b>	41 x 41 x 400 	x 7
<b>867</b>	40 x 60 x 1878  	x 3	<b>906</b>	40 x 80 x 2295 	x 10
<b>957</b>	40 x 60 x 1451 	x 1	<b>944</b>	40 x 60 x 1878  	x 1
<b>857</b>	40 x 60 x 500  	x 8	<b>984</b>	40 x 60 x 759 	x 1
			<b>874</b>	40 x 80 x 200  	x 9

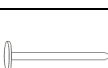
# BCLAI2(NF/GR)

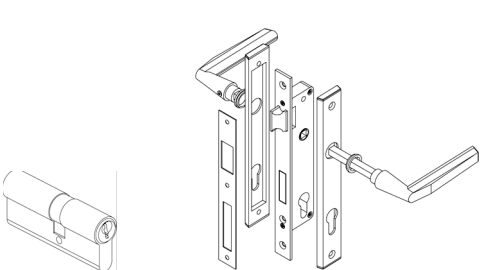
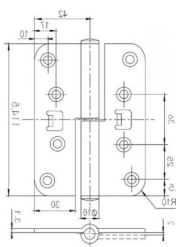
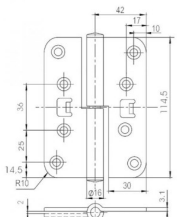
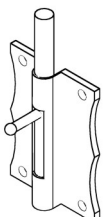
ID	Details in mm (Tolerance/Toleranz ...+2mm)	Pcs.	ID	Details in mm (Tolerance/Toleranz ...+2mm)	Pcs.
985	41 x 41 x 1877 	x 2	986	41 x 41 x 1027 	x 2
998	41 x 41 x 217 	x 2	999	41 x 41 x 129 	x 2
960	28 x 28 x 1371 	x 1	988	28 x 28 x 679 	x 1
756	19 x 45 x 2245 	x 4	961	19 x 45 x 1451 	x 1
990	19 x 45 x 759 	x 1	670	12 x 90 x 2245 	x 16
996	12 x 90 x 1567 	x 3	648	12 x 90 x 1325 	x 4
995	12 x 90 x 285 	x 2	595	12 x 42 x 1926 	x 5
964.	12 x 42 x 1495 	x 3	628	12 x 90 x 201 	x 4
982	15 x 15 x 552 	x 12	1133	15 x 15 x 400	} (NB! BCLAI2GR) 
983	15 x 15 x 368 	x 12	1134	15 x 15 x 554	
997	1 x 1000 x 4800 	x 3	1510	Ø4,5 x 19 	x 16
1501.	Ø4,5 x 75 	x 18	1502	Ø4,5 x 75 	x256
1503	Ø4,5 x 50 	x196	1506	Ø3,5 x 35 	x167
1506	Ø4 x 25 	x 16	1508	Ø1,5 x 25 	x 84
1512	Ø3 x 14 	x264	1557		x 4
1531 1531-1		x 2	1555	Left/Linke 	x 2
1527	Right/Rechte 	x 4	1517		x 2

**NB!**

Empfohlen bei Aufbau auf besonders feuchtem Untergrund.

Recommended for assembly on moist ground.

**\* Nicht im Lieferumfang enthalten / Not included!**

\* Unterlagspad /

\* Patio Pads

Min. 30 lfm/rm

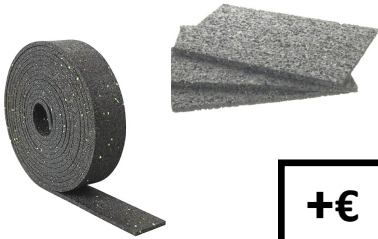

+€

\* Imprägniert Kantholz /

\* Impregnated beam

40\*60\*2300 mm

13 Stck/Pcs



+€

\* Schraube /

\* Screw

4,5\*80 mm

78 Stck/Pcs



+€

**Fundamentplan / Foundation Plan**

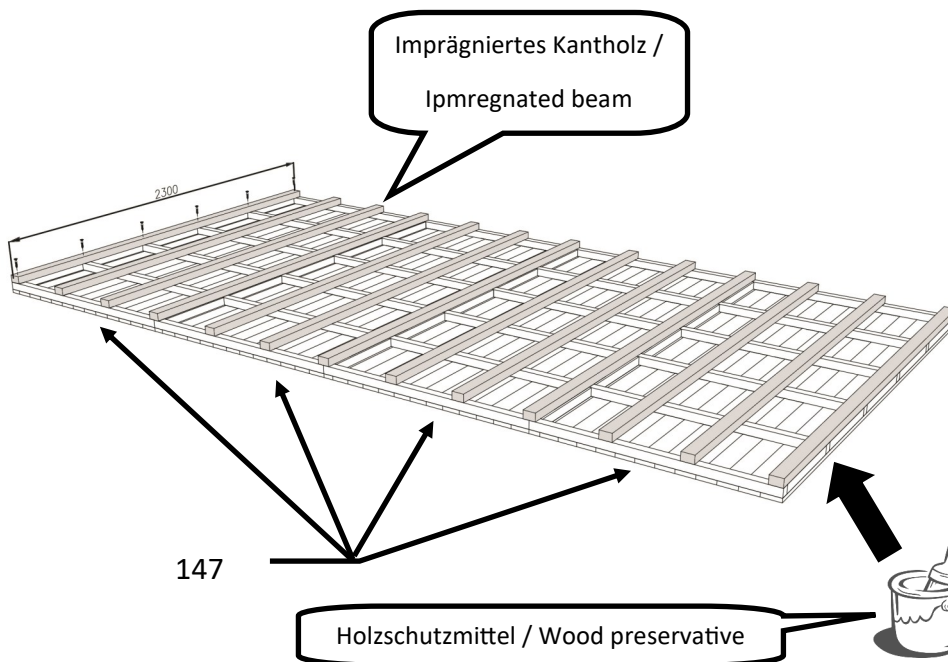
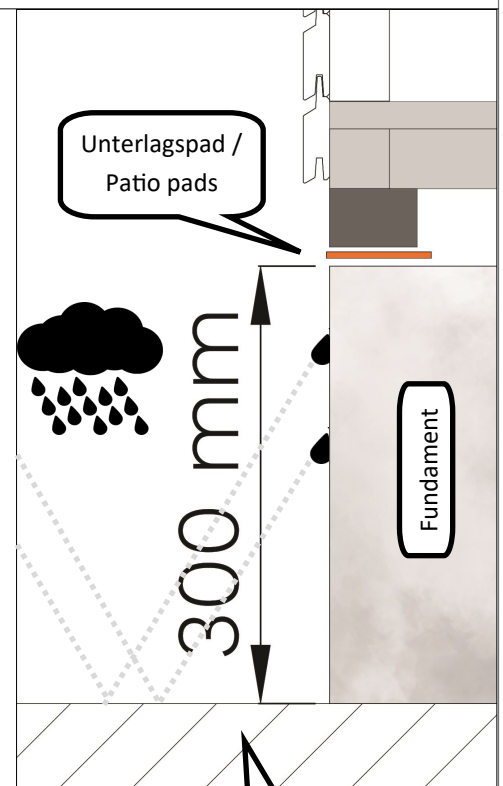
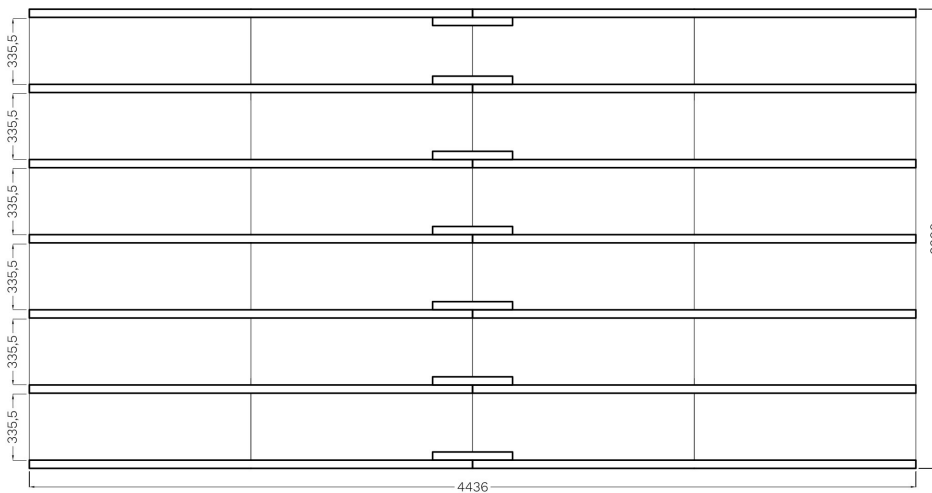

**Bitte beachten!**

Lass Dein Bauvorhaben vorab bei Deiner zuständigen Gemeinde prüfen, denn die Bauordnungen sowie die Bebauungspläne müssen eingehalten werden.

**Please note!**

Have your construction project checked in advance at your responsible municipality, because the building regulations and the development plans must be observed.

# BCLAI2(NF/GR)

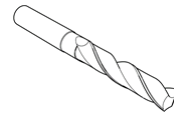
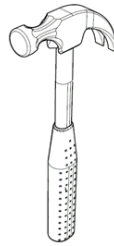
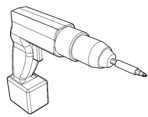

Ø 4 mm  
Ø 8 mm

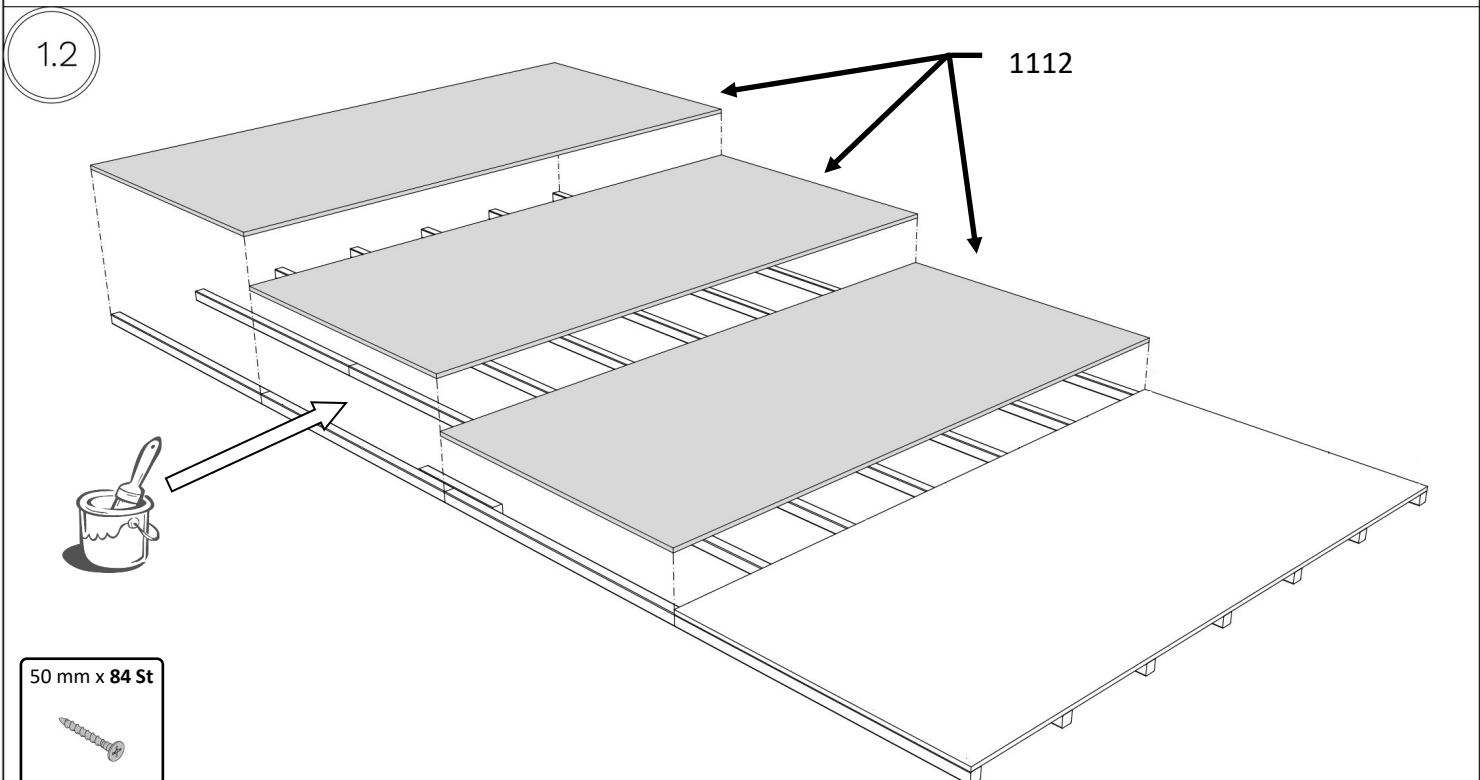
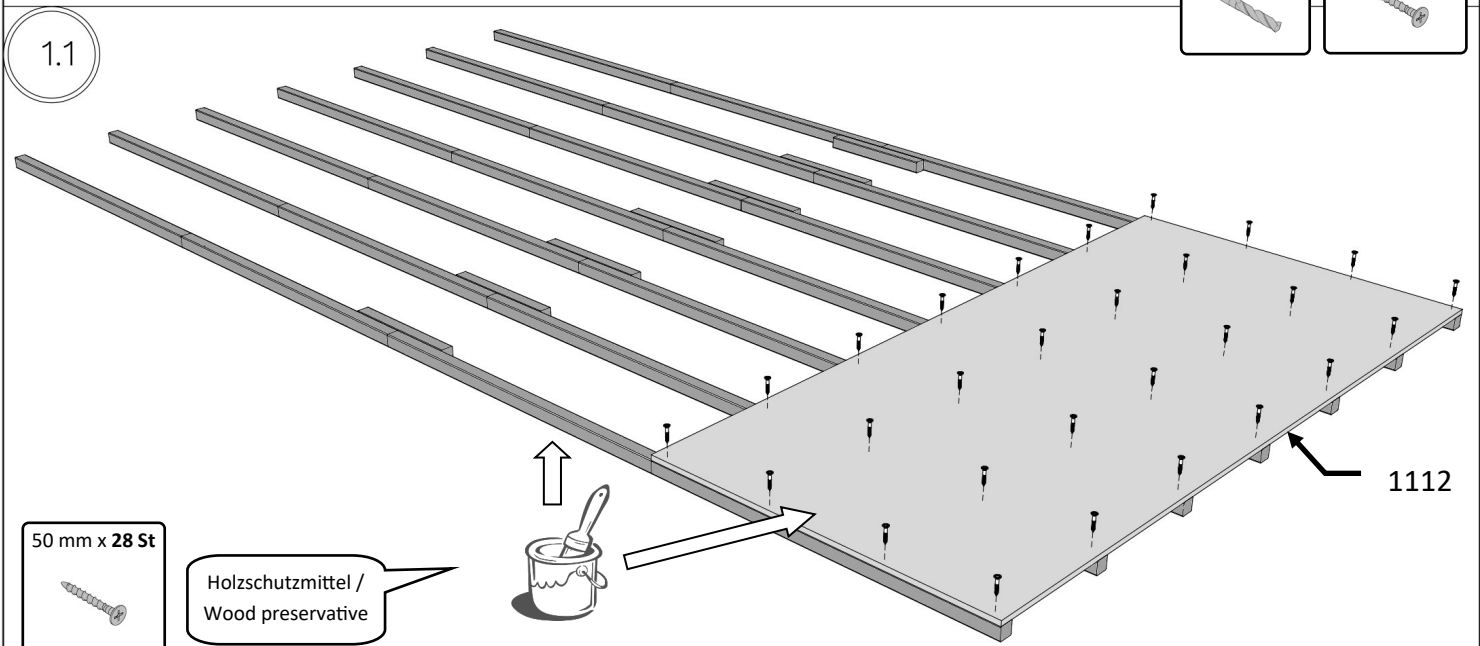
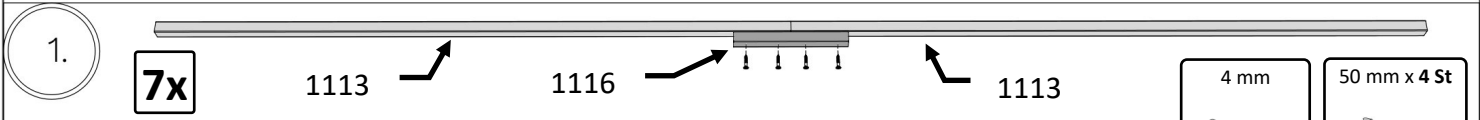
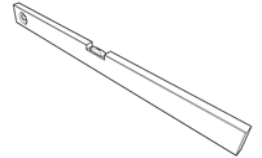
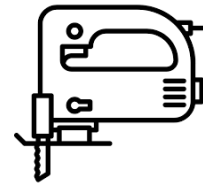
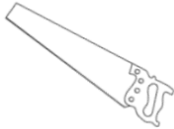
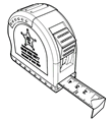

# BCLAI2(NF/GR)

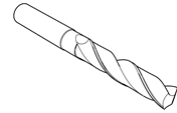
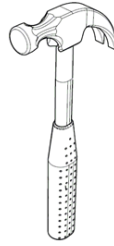
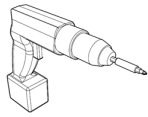

Ø 4 mm  
Ø 8 mm

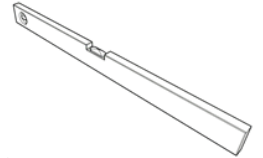
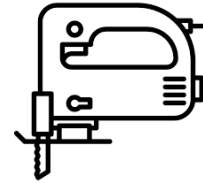
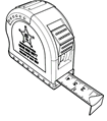

2.

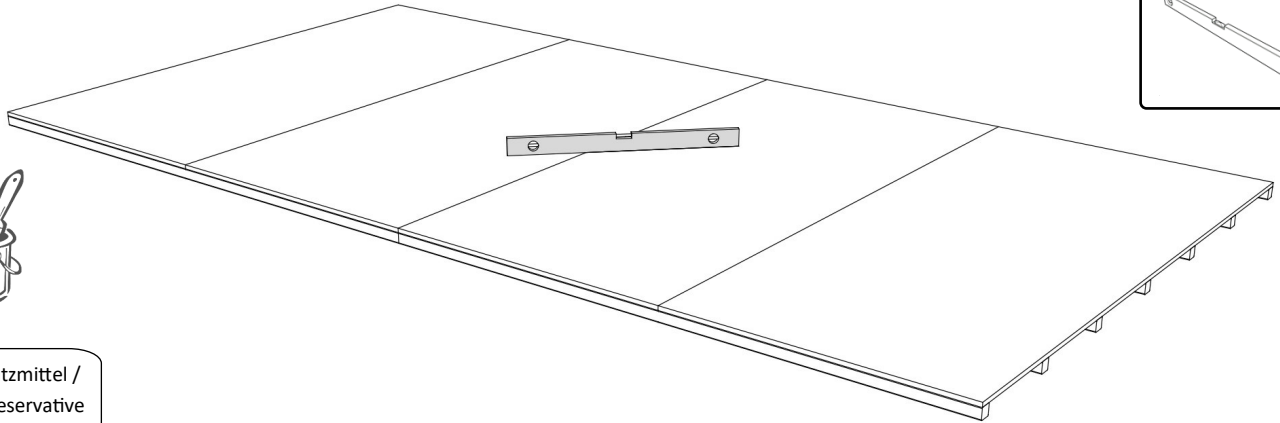

Holzschutzmittel /  
Wood preservative

3.

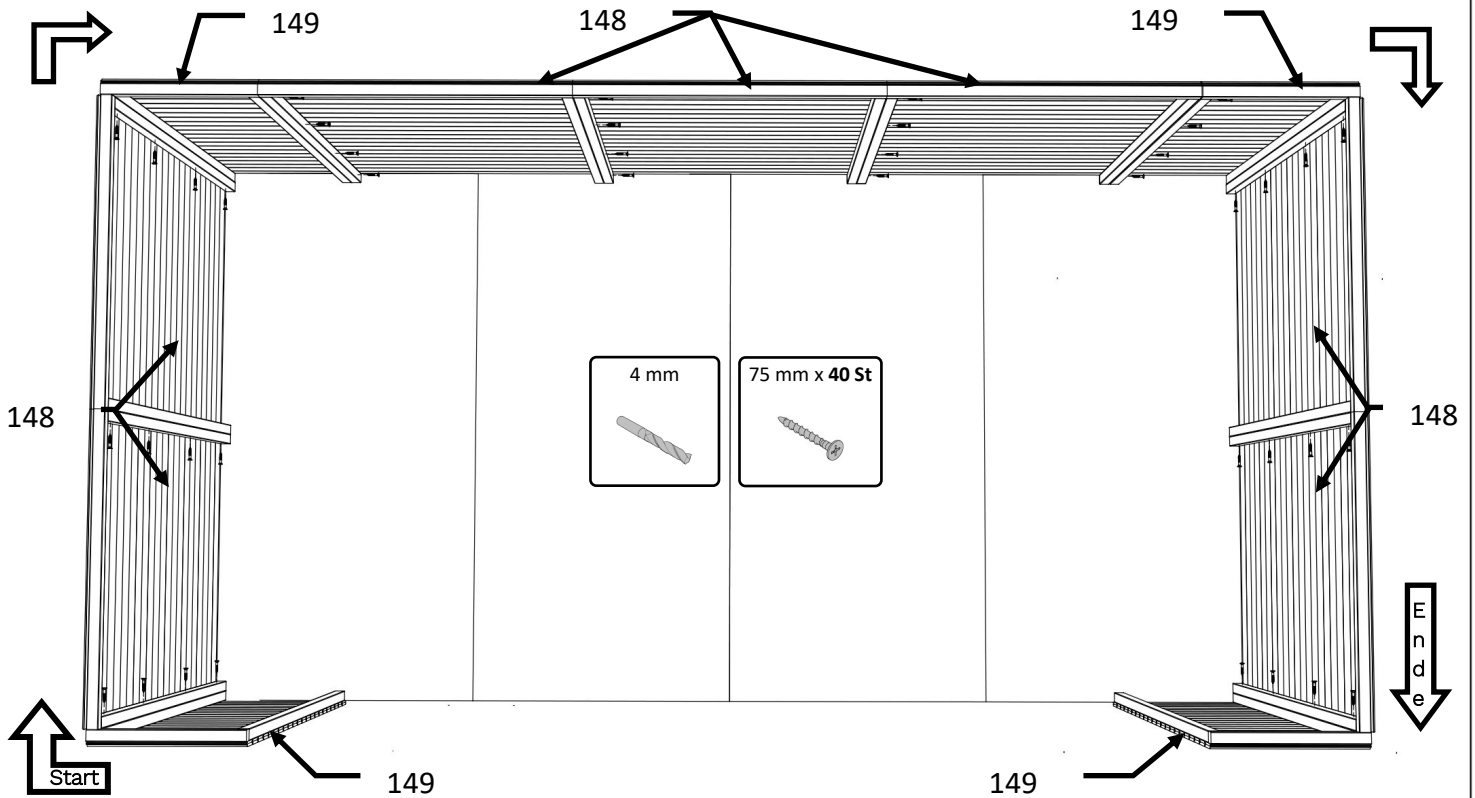

# BCLAI2(NF/GR)

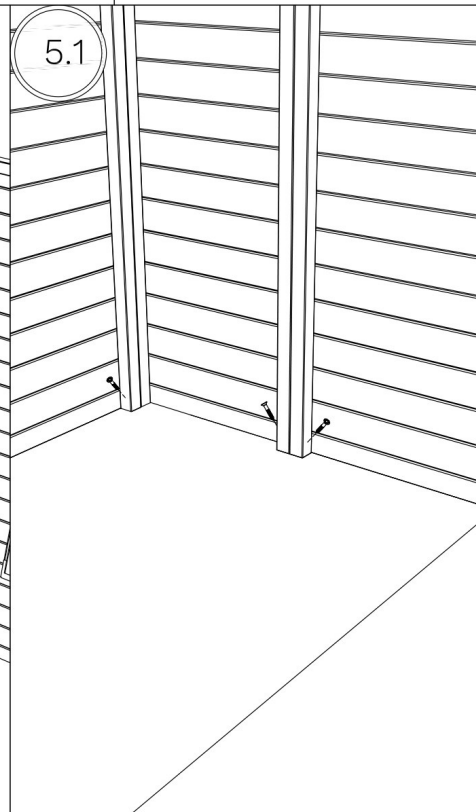
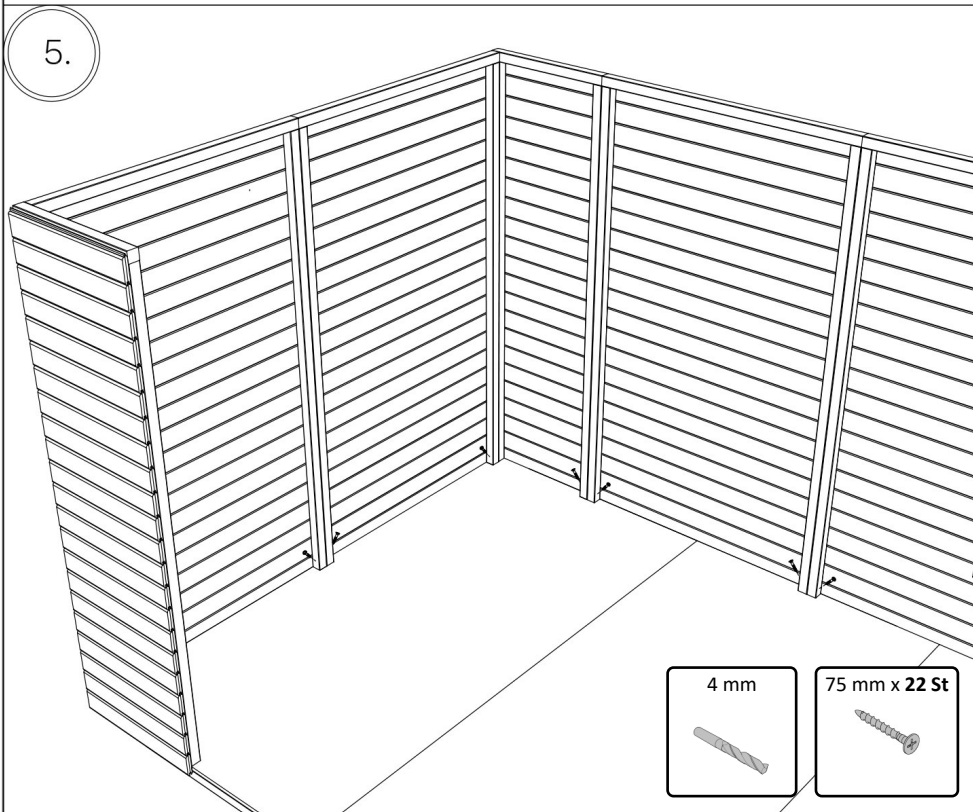
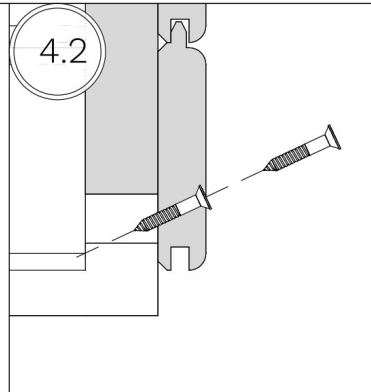
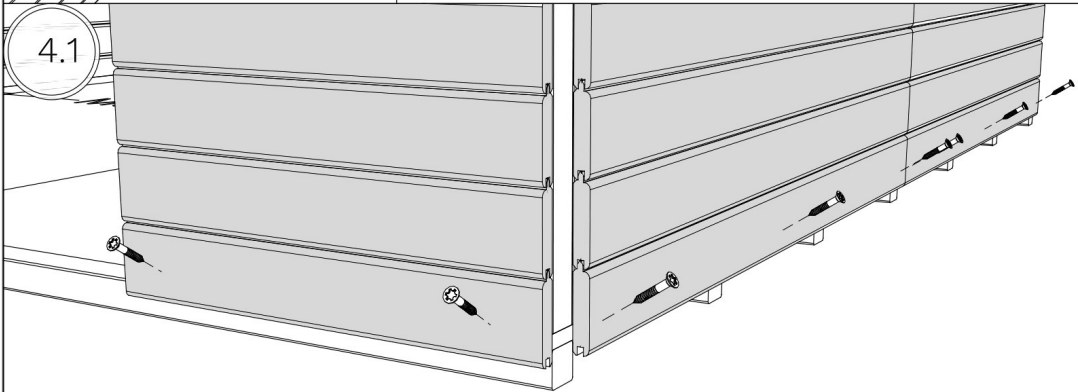
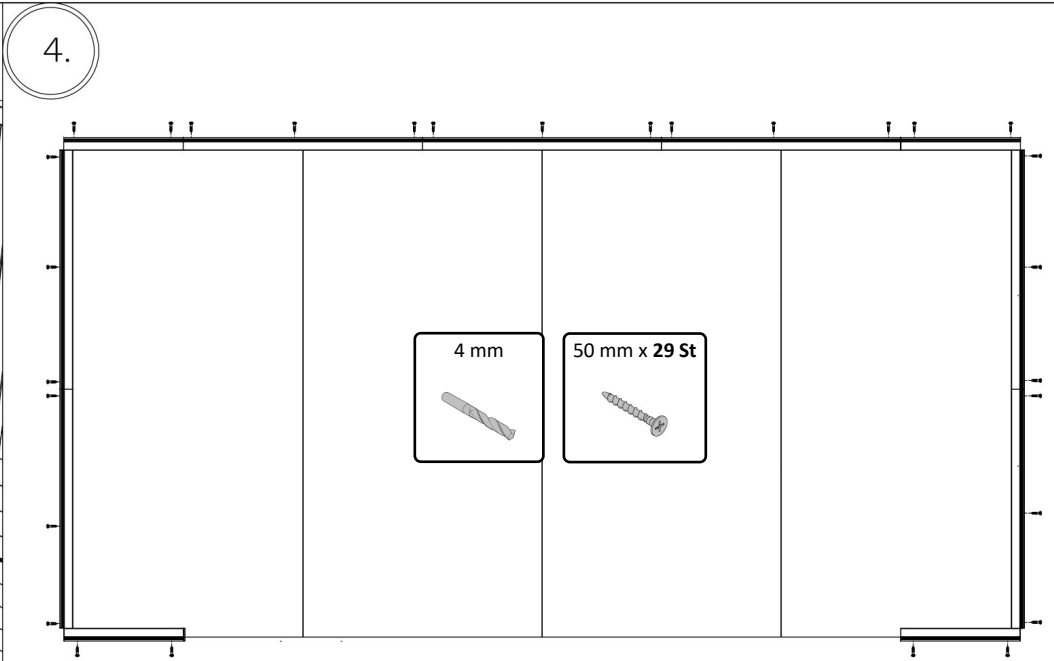
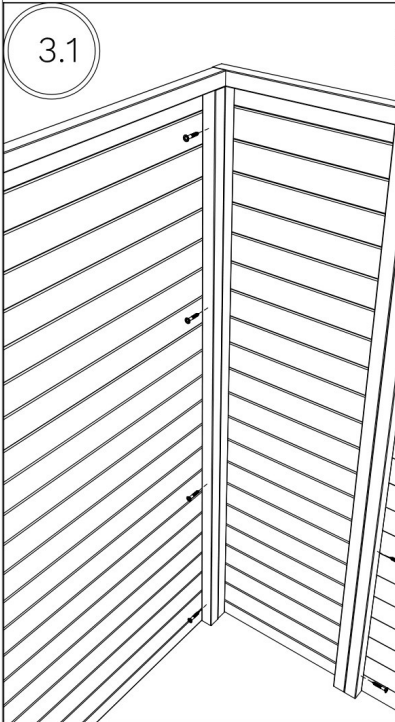



# BCLAI2(NF/GR)

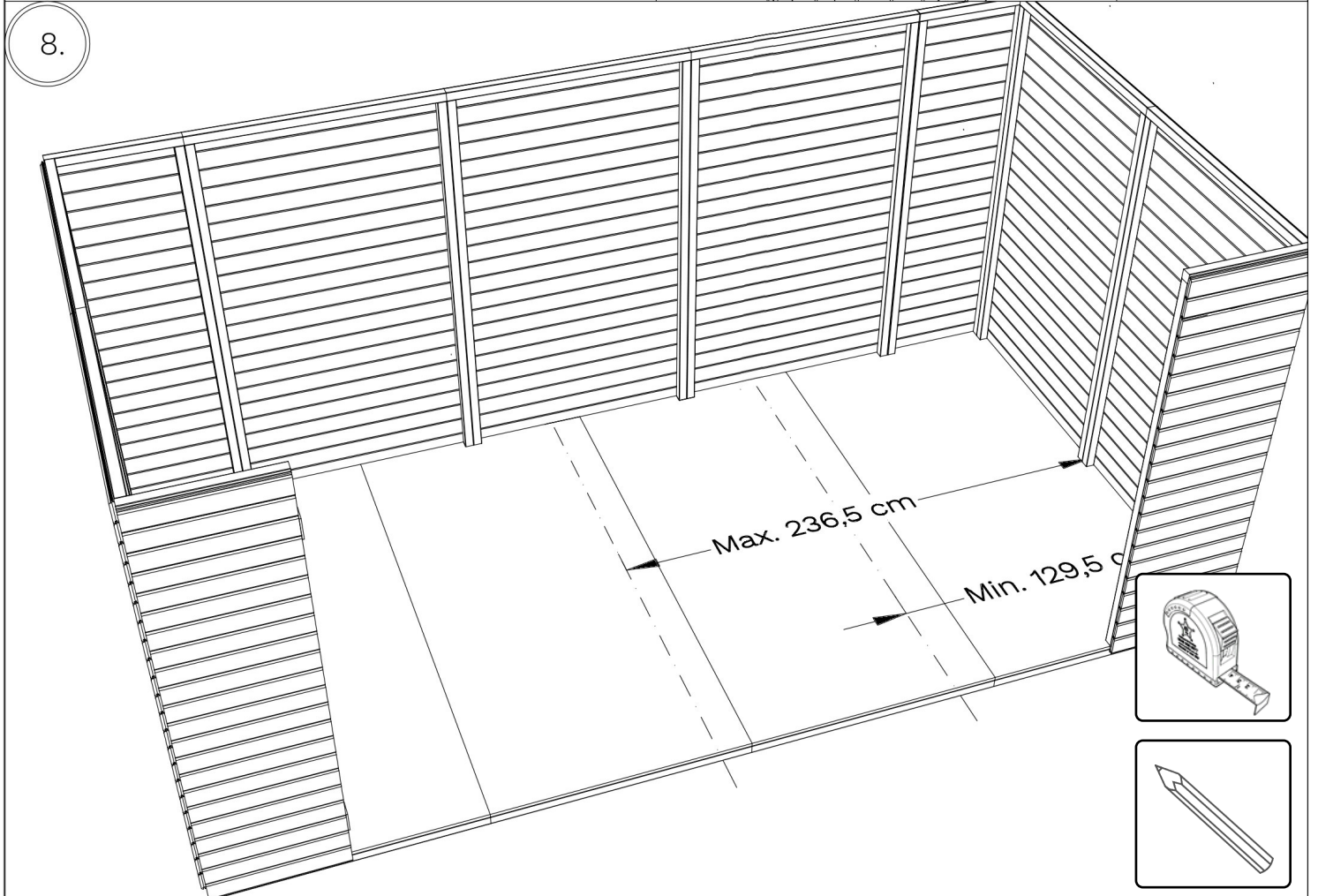
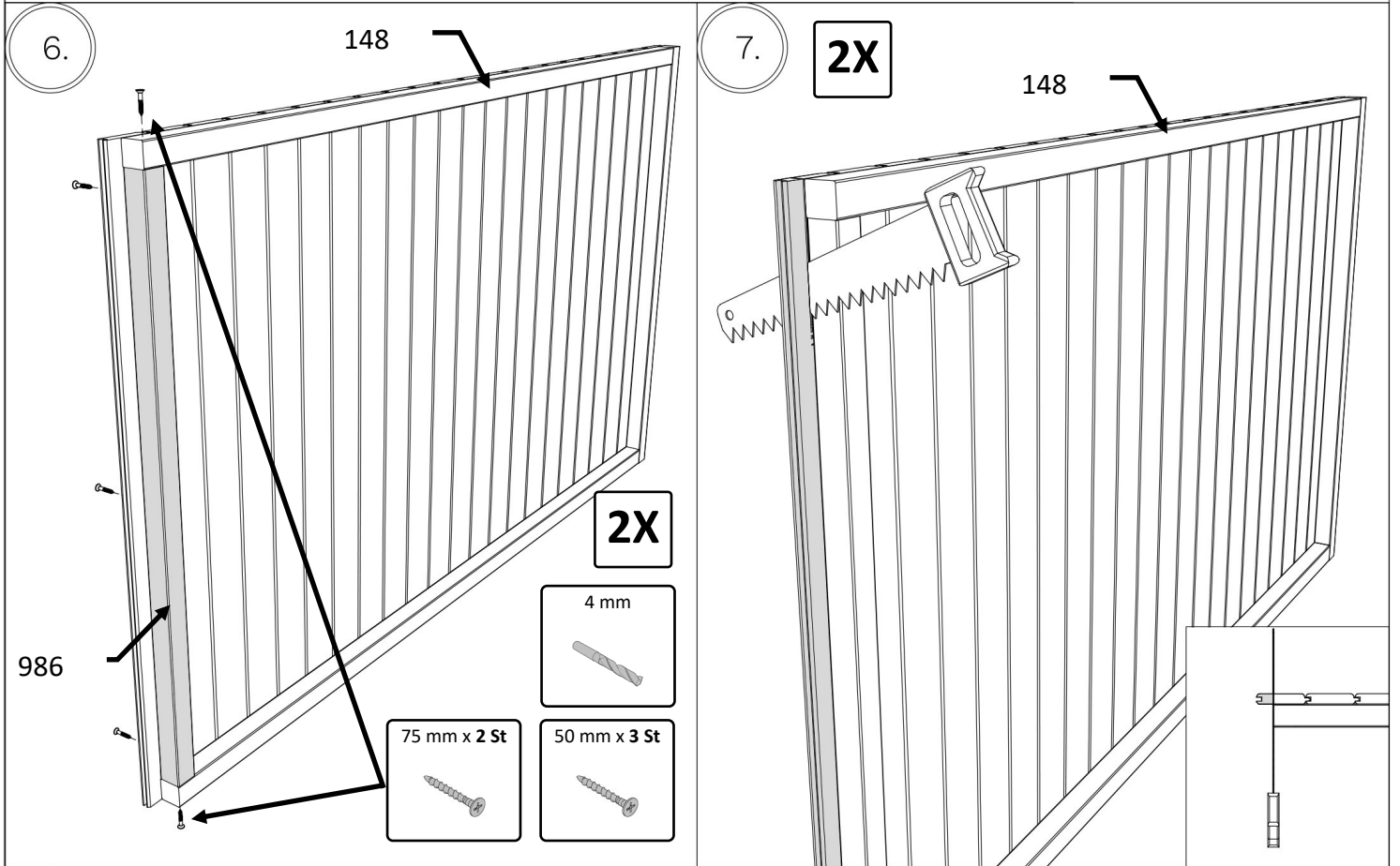

# BCLAI2(NF/GR)

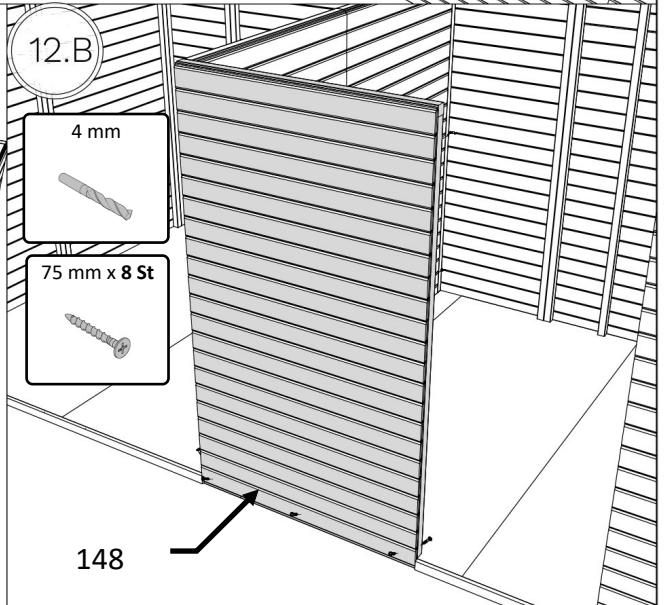
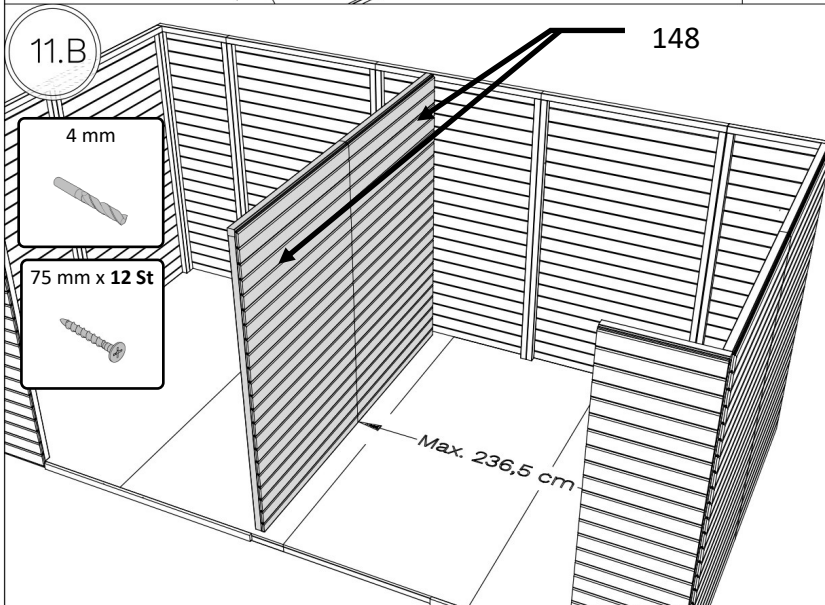
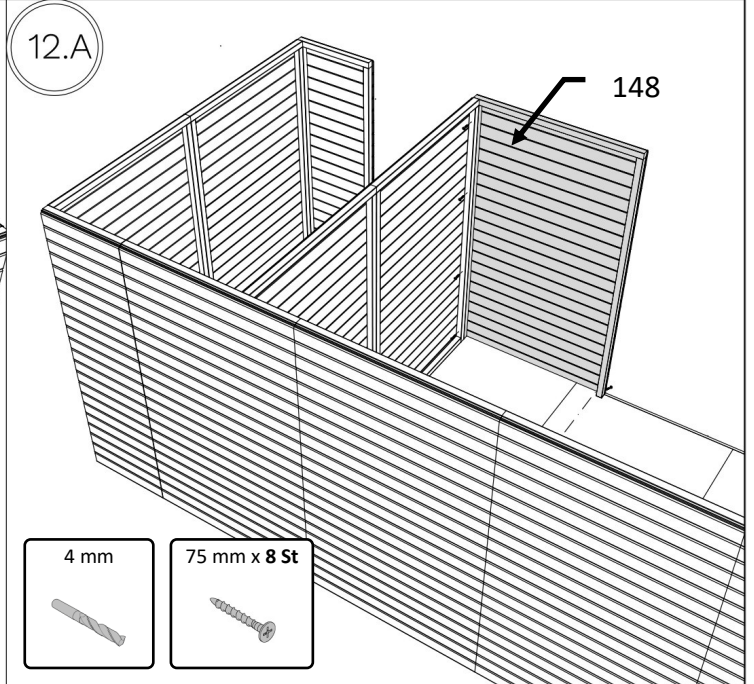
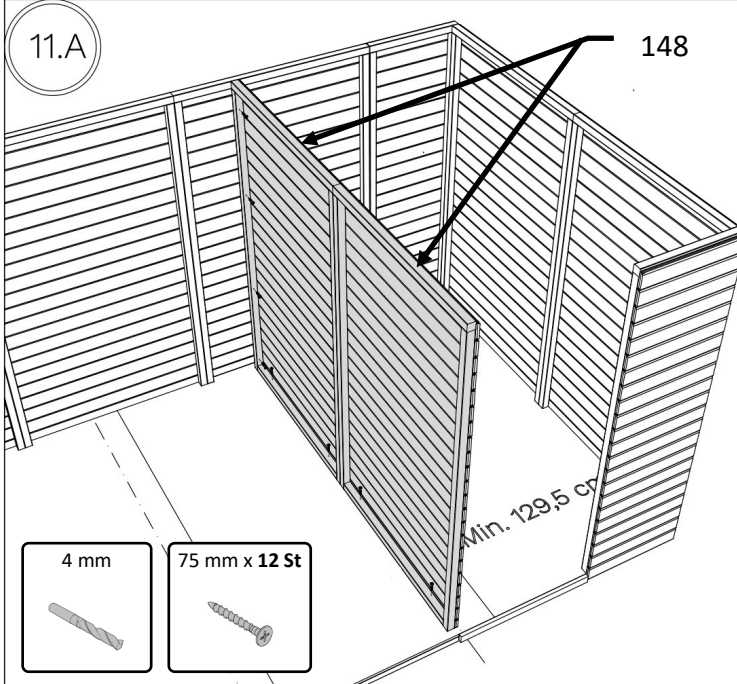
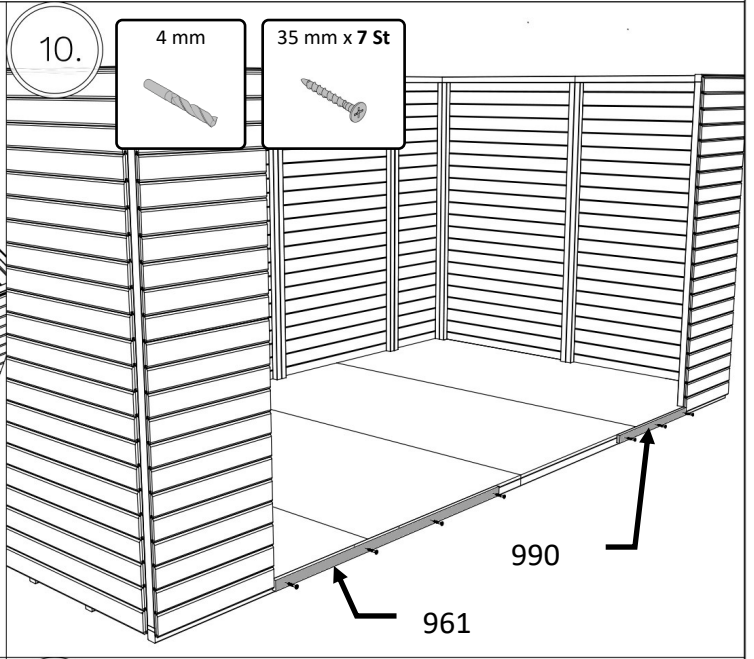
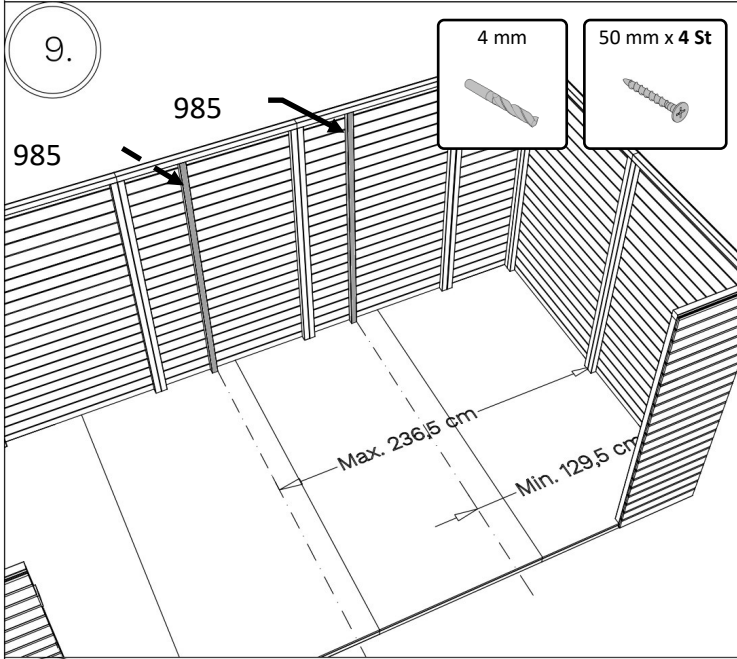

# BCLAI2(NF/GR)

13.

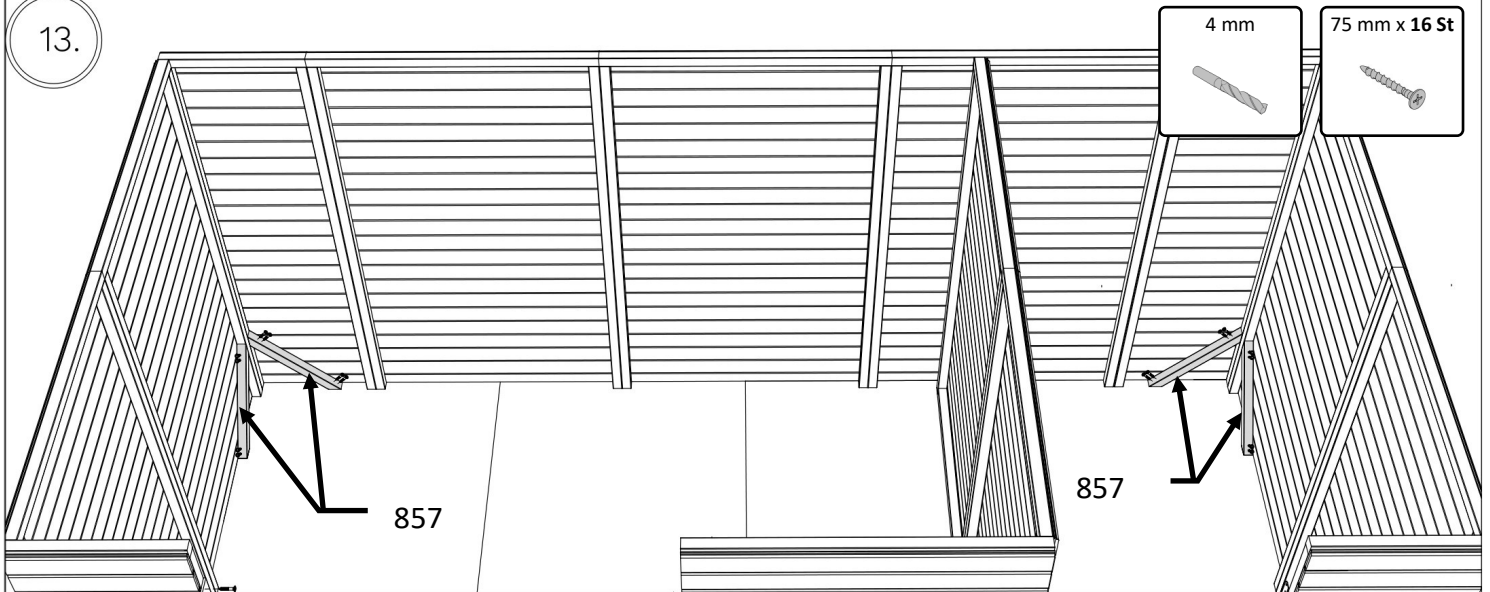

14.

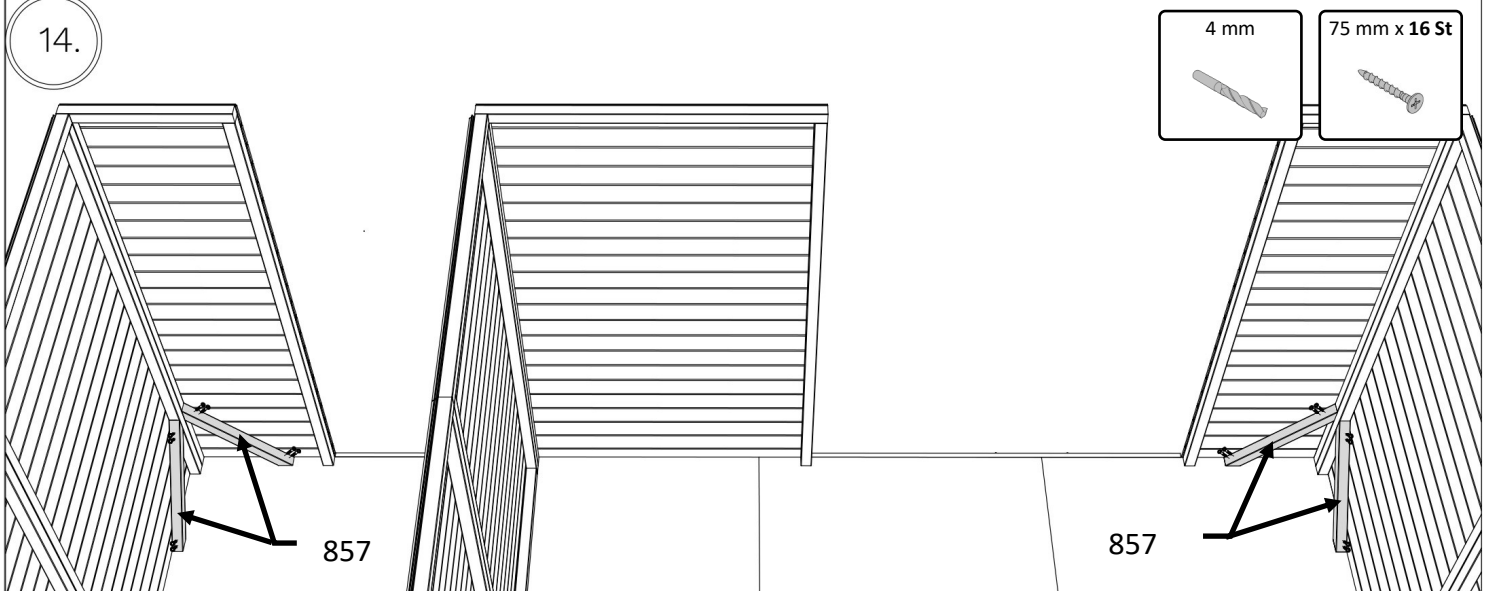

15.

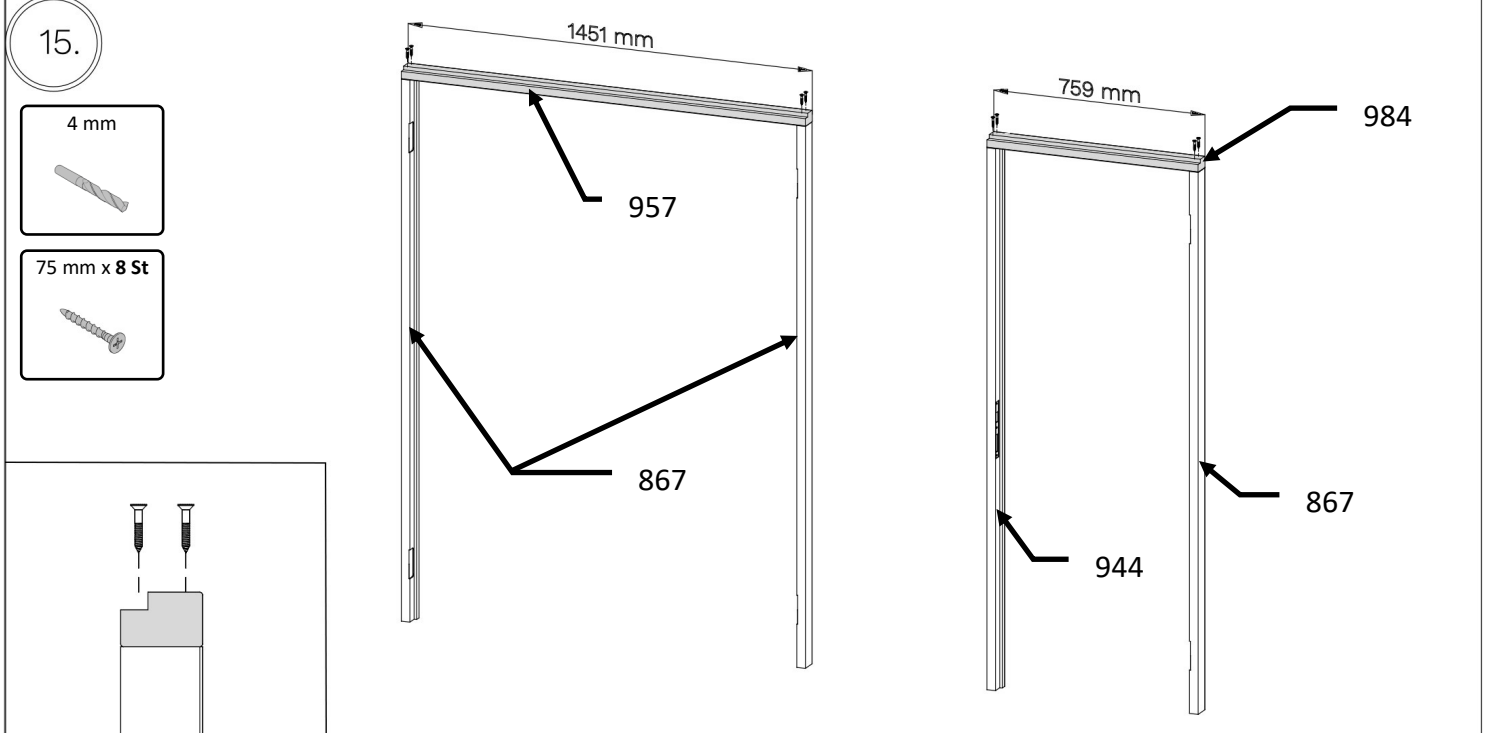

# BCLAI2(NF/GR)

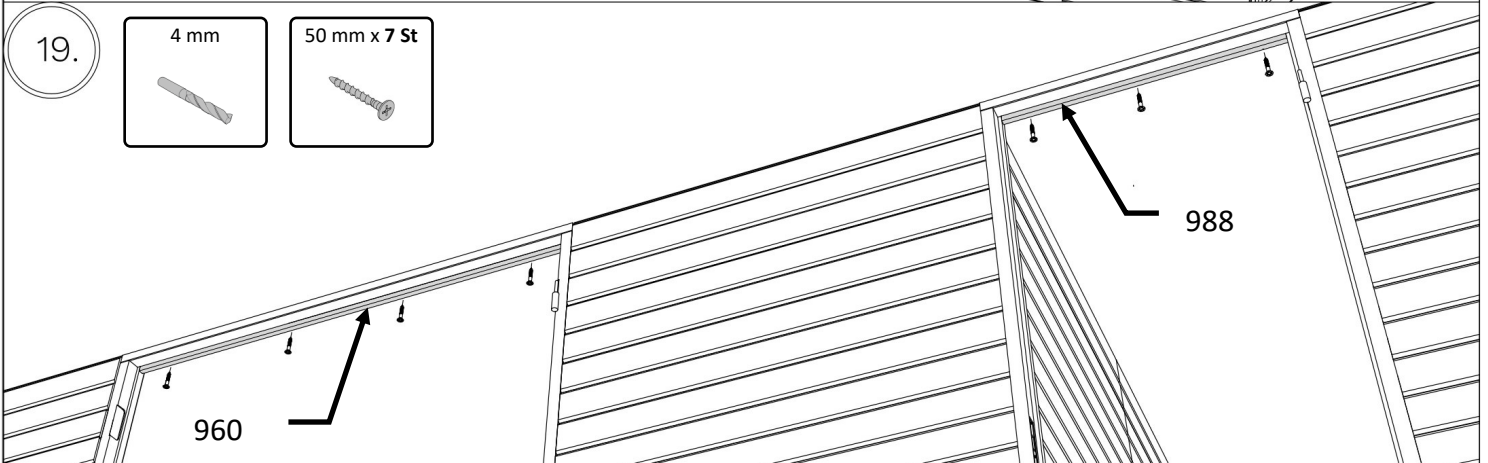
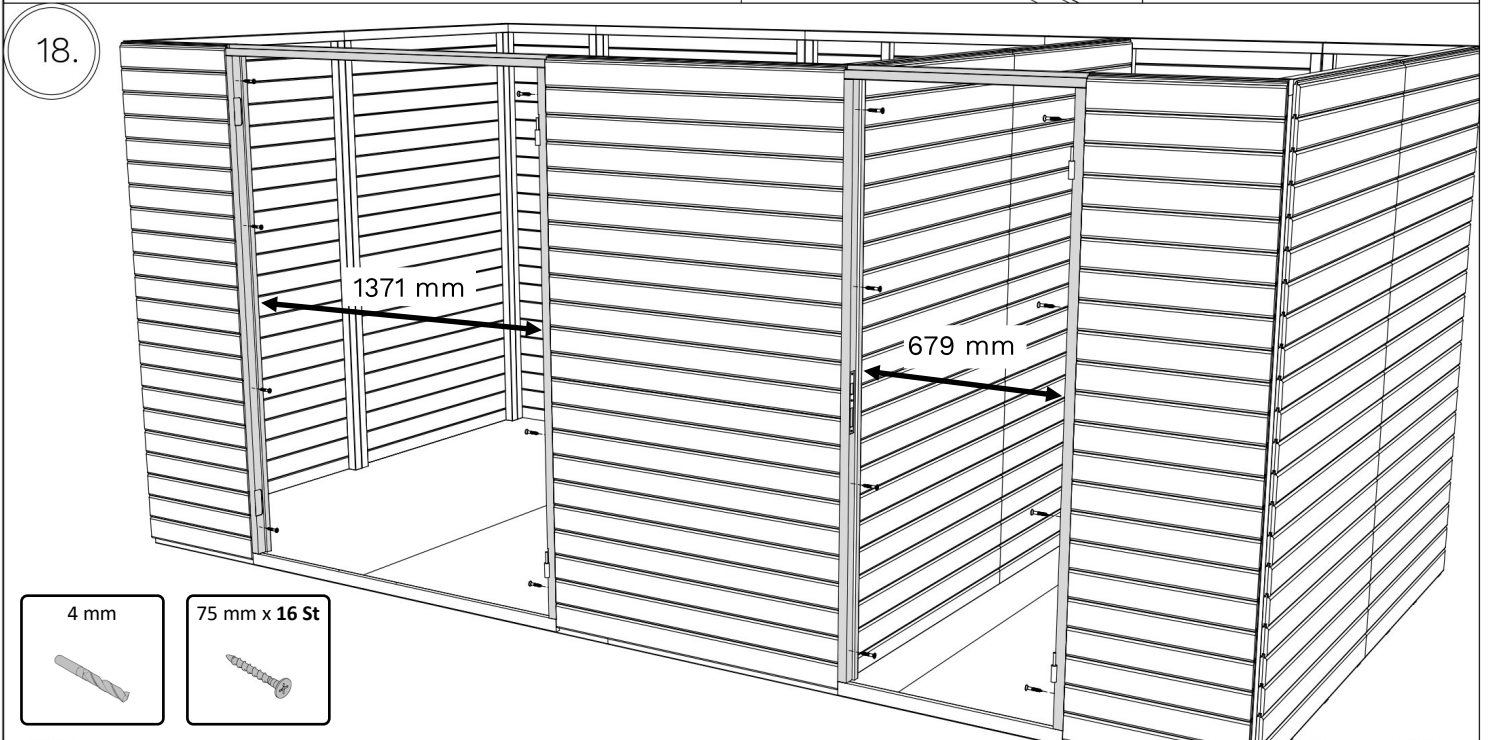
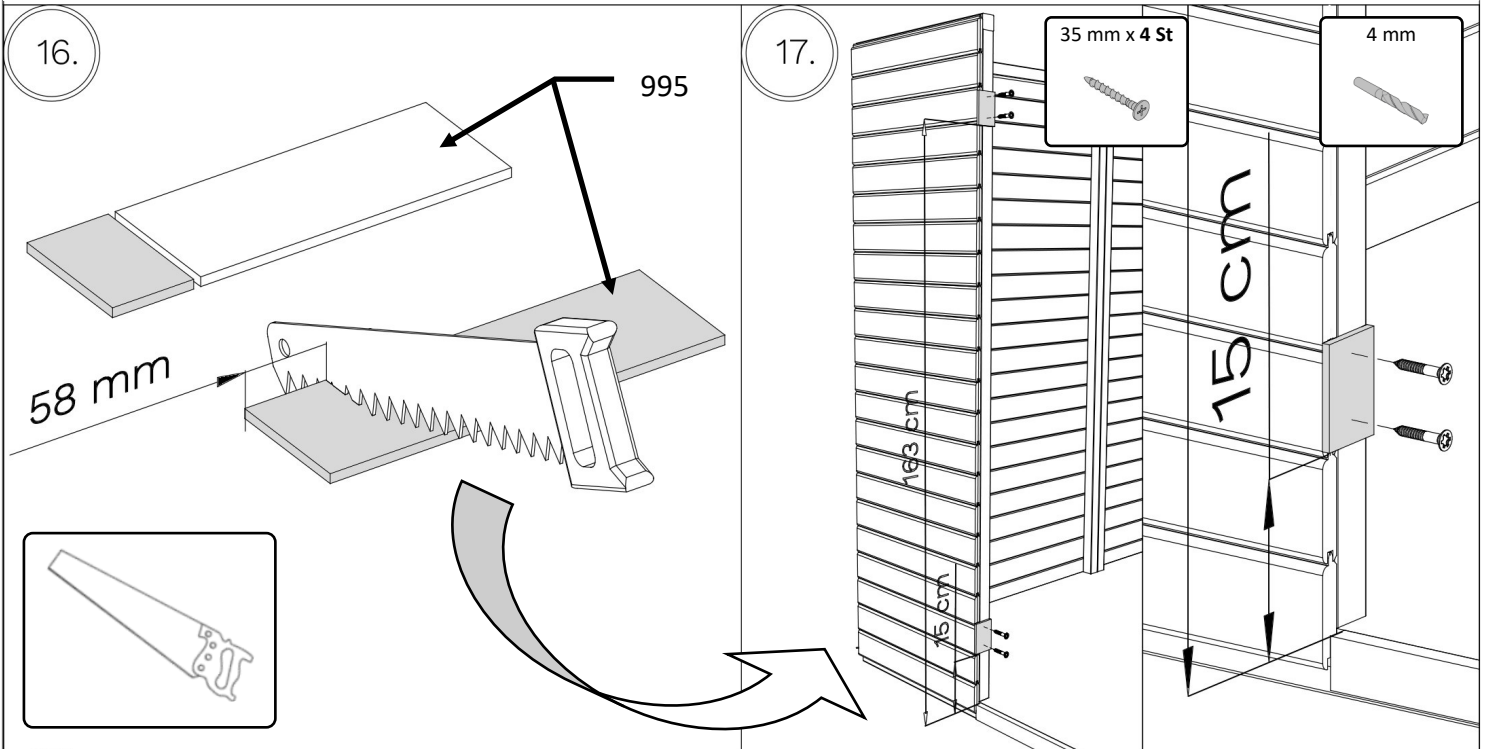

# BCLA12(NF/GR)

20.

4 mm

75 mm x 6 St

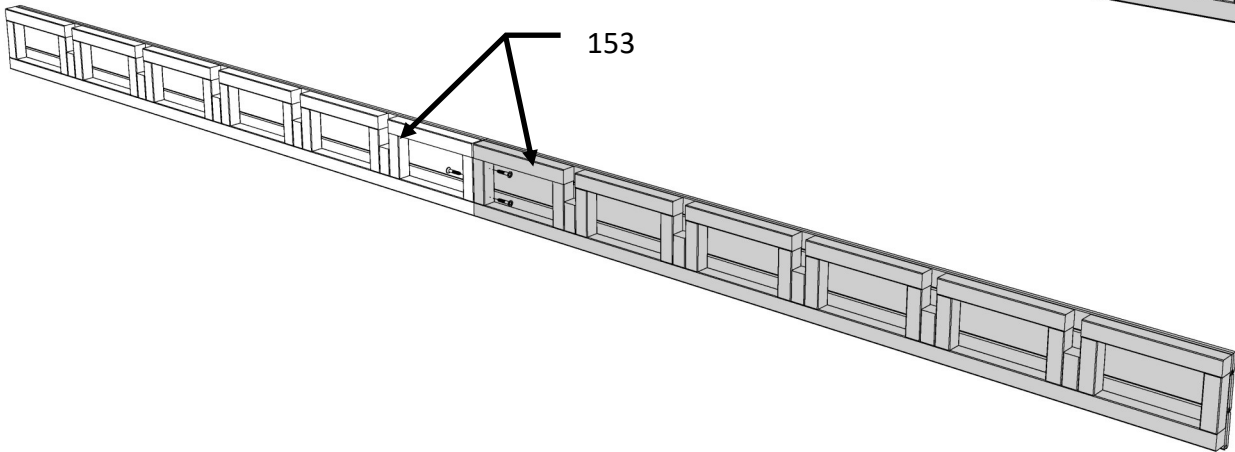
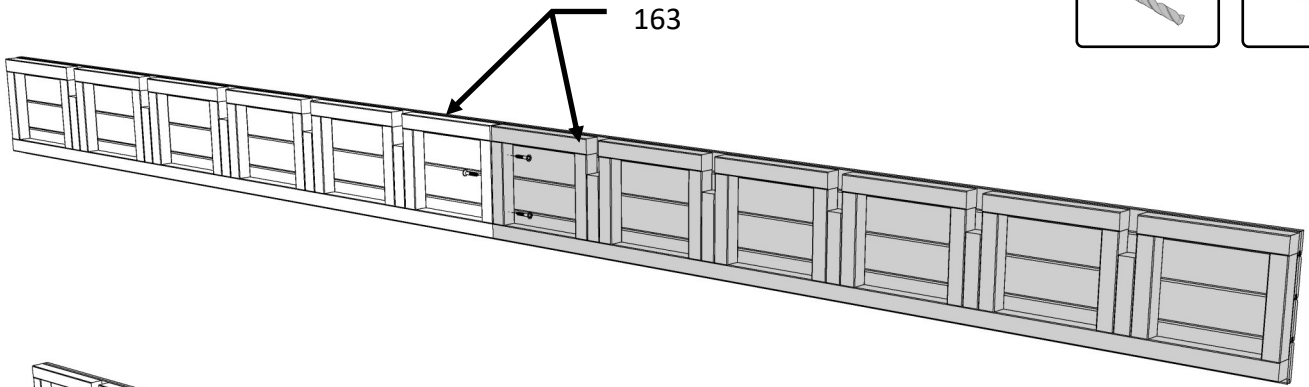

21.

4 mm

75 mm x 12 St



163

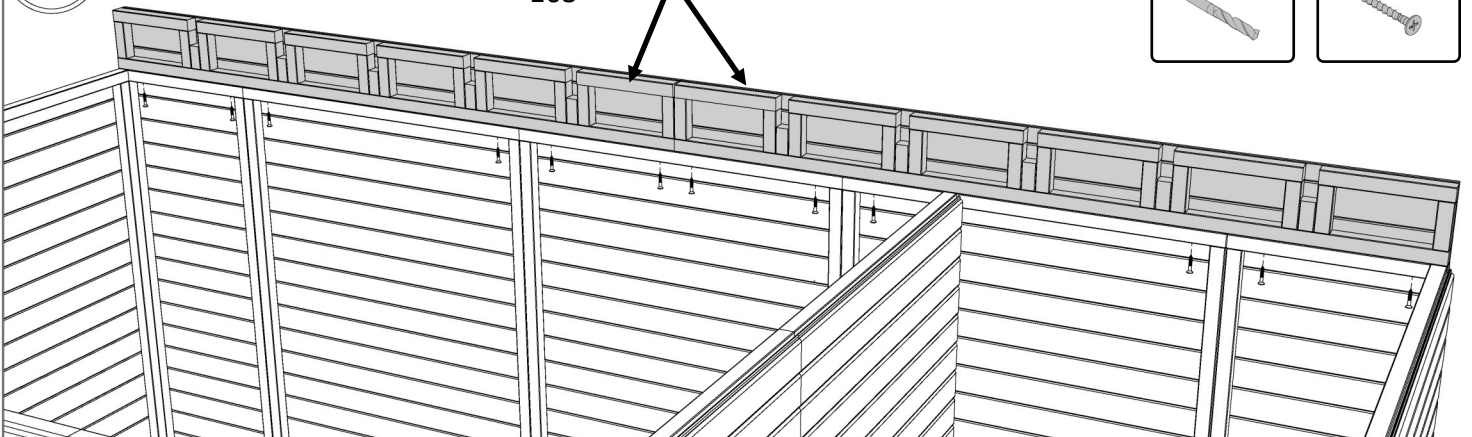

22.

4 mm

75 mm x 13 St



153

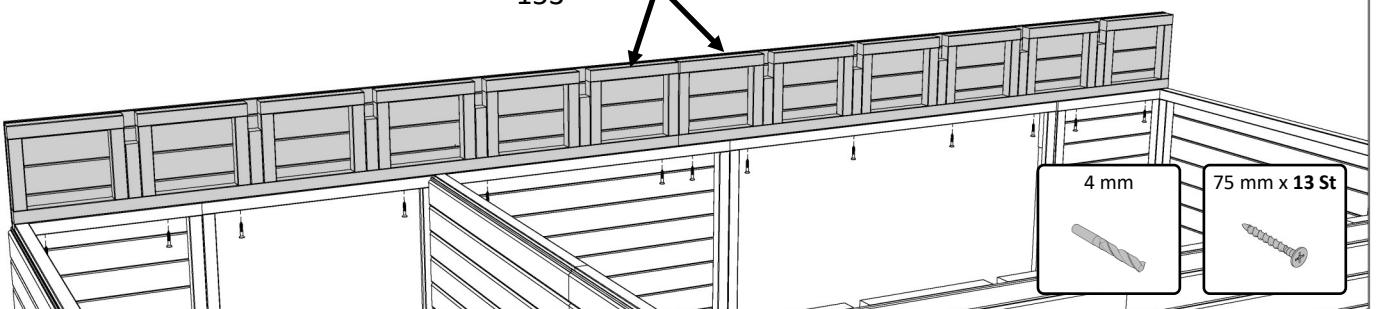

# BCLA12(NF/GR)

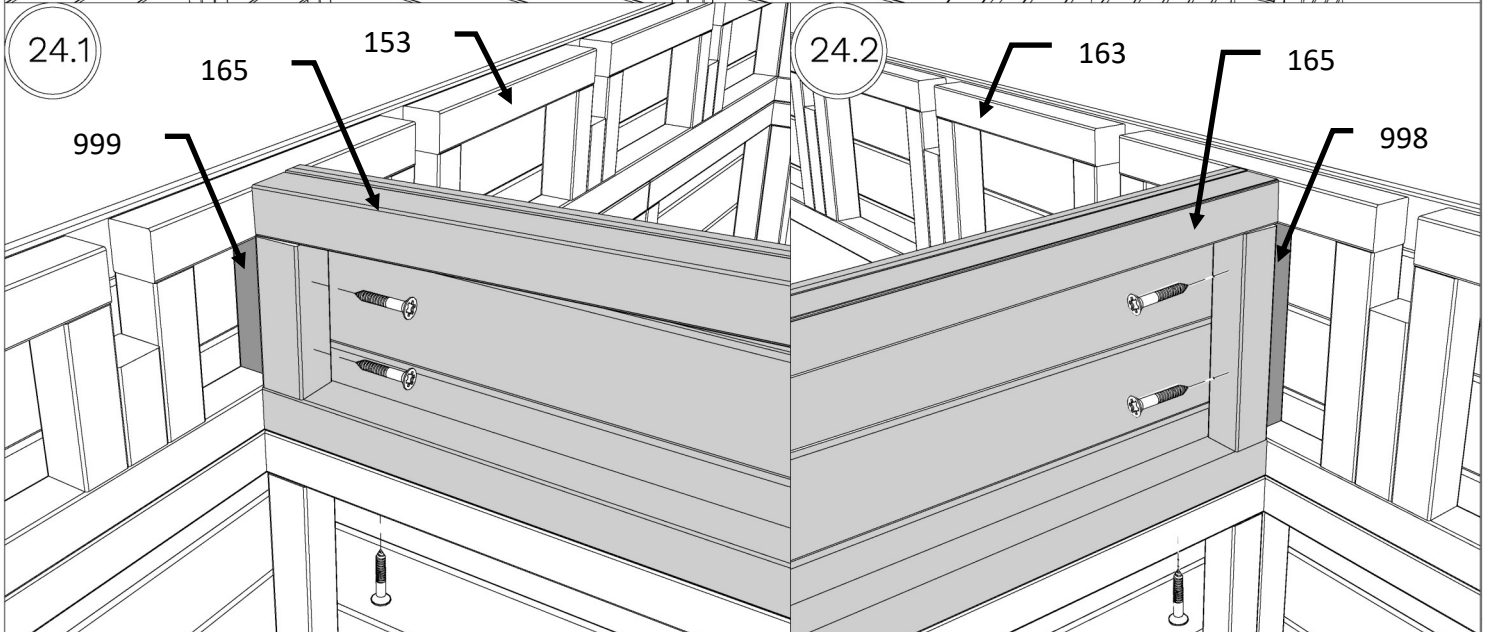
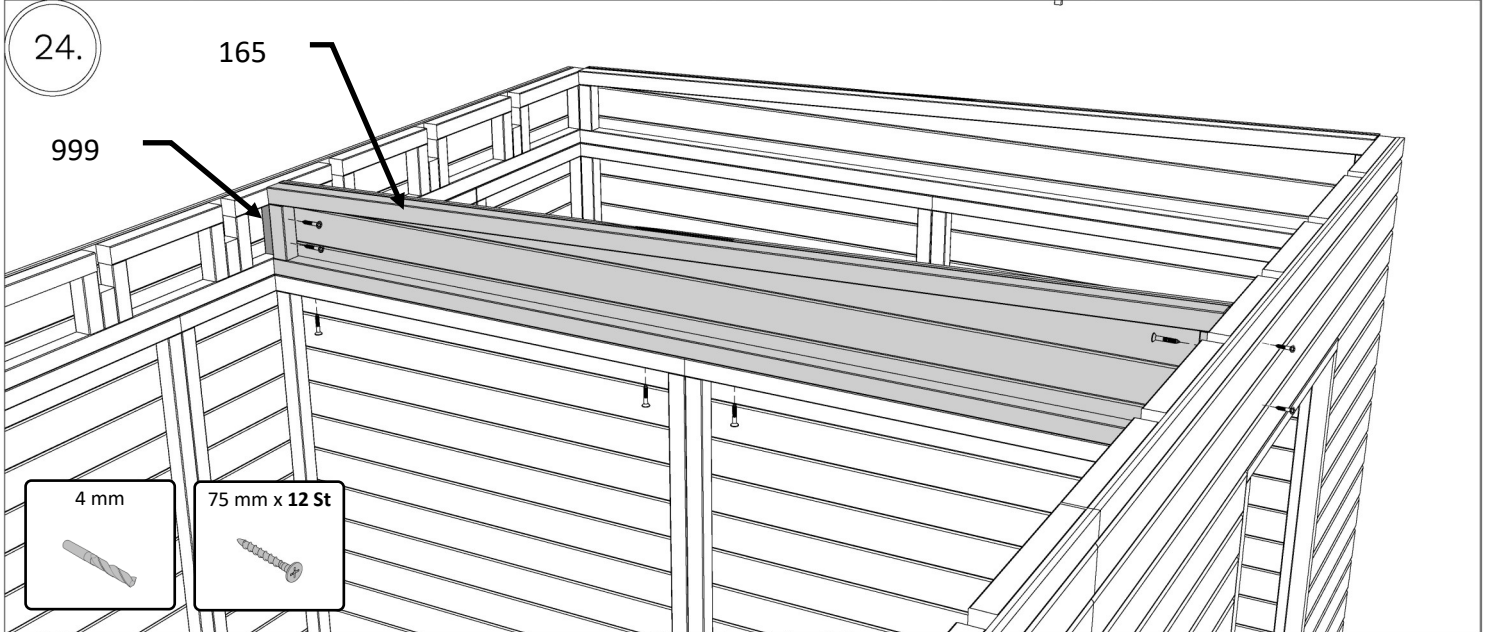
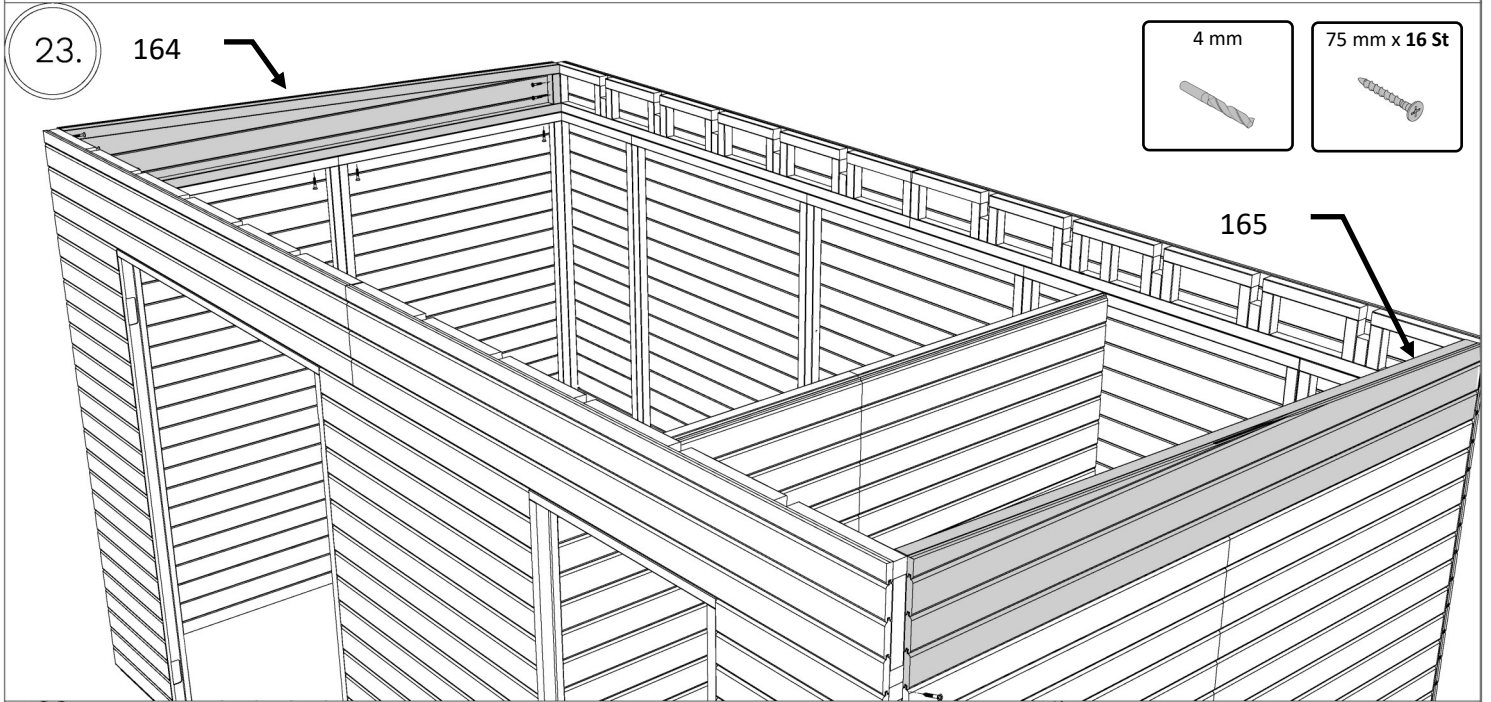

# BCLAI2(NF/GR)

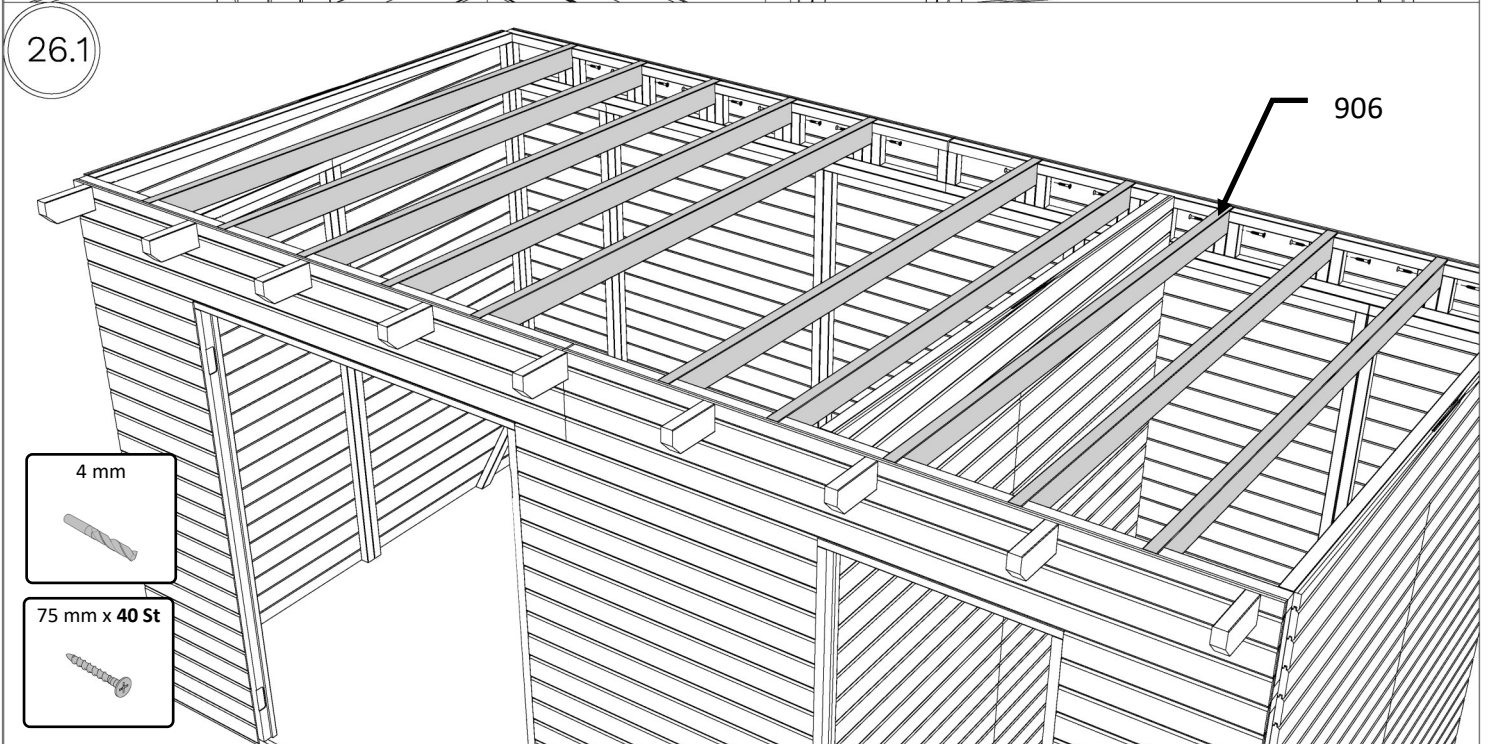
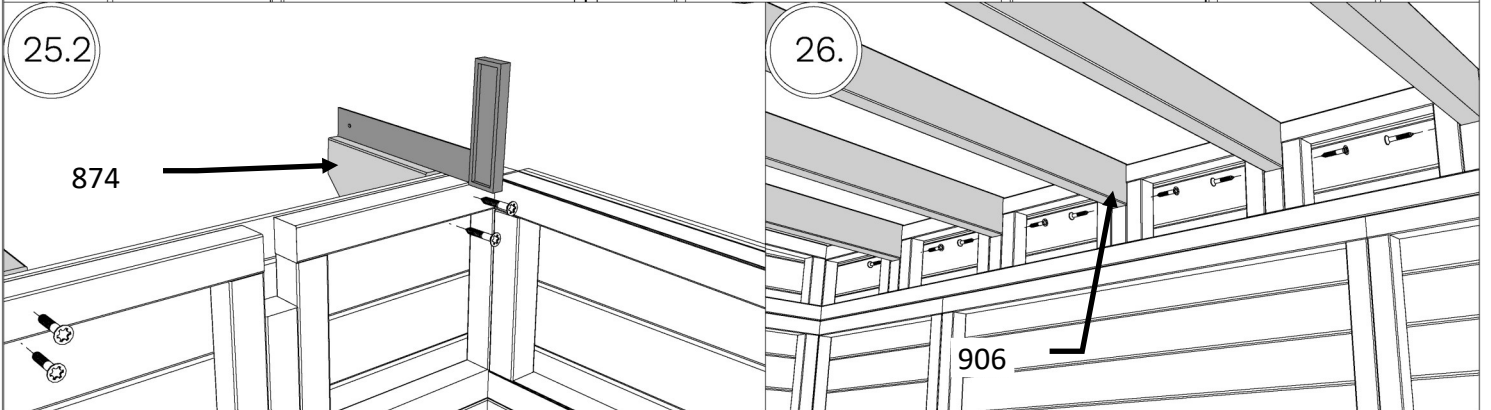
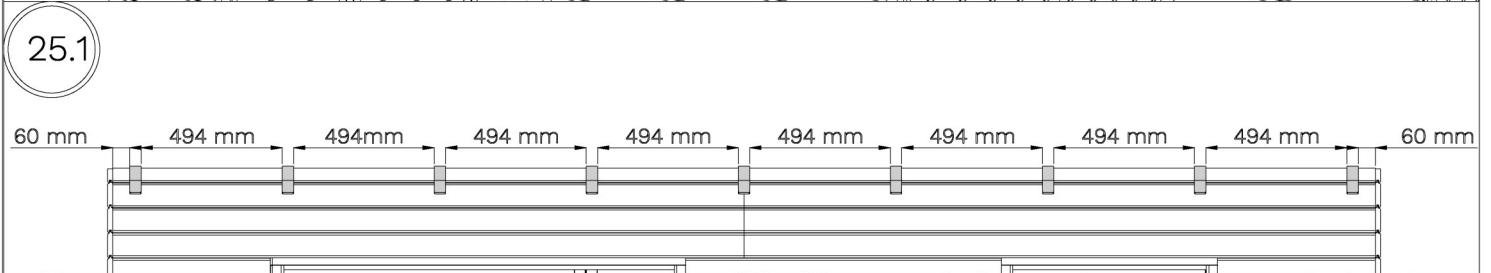
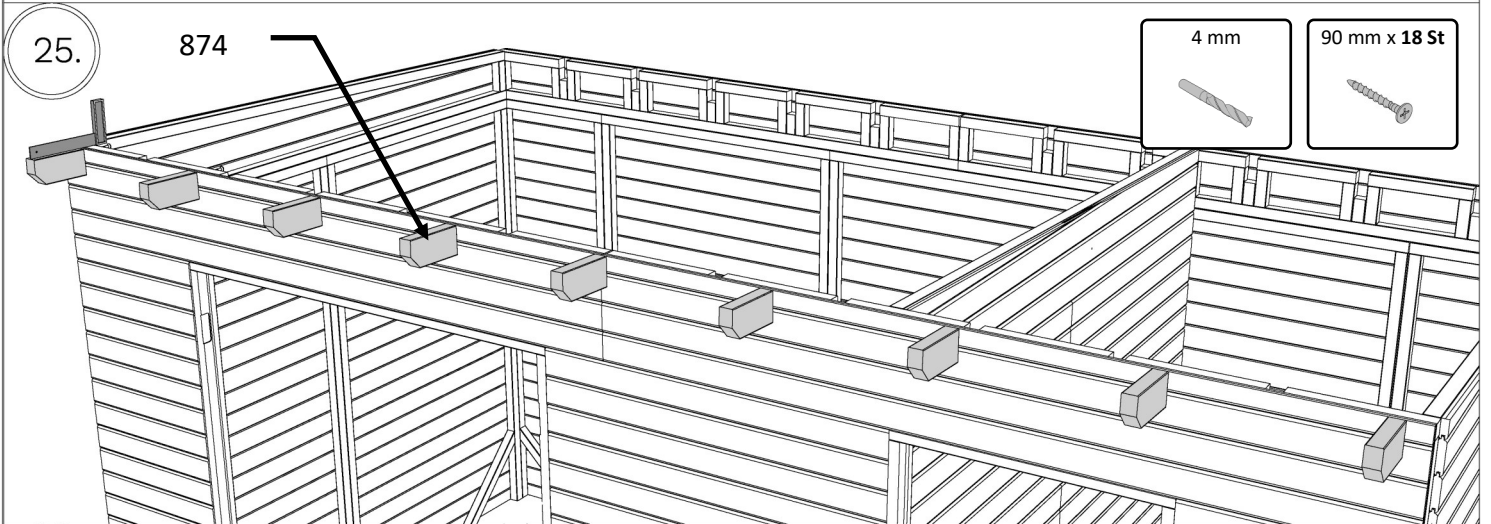

# BCLA12(NF/GR)

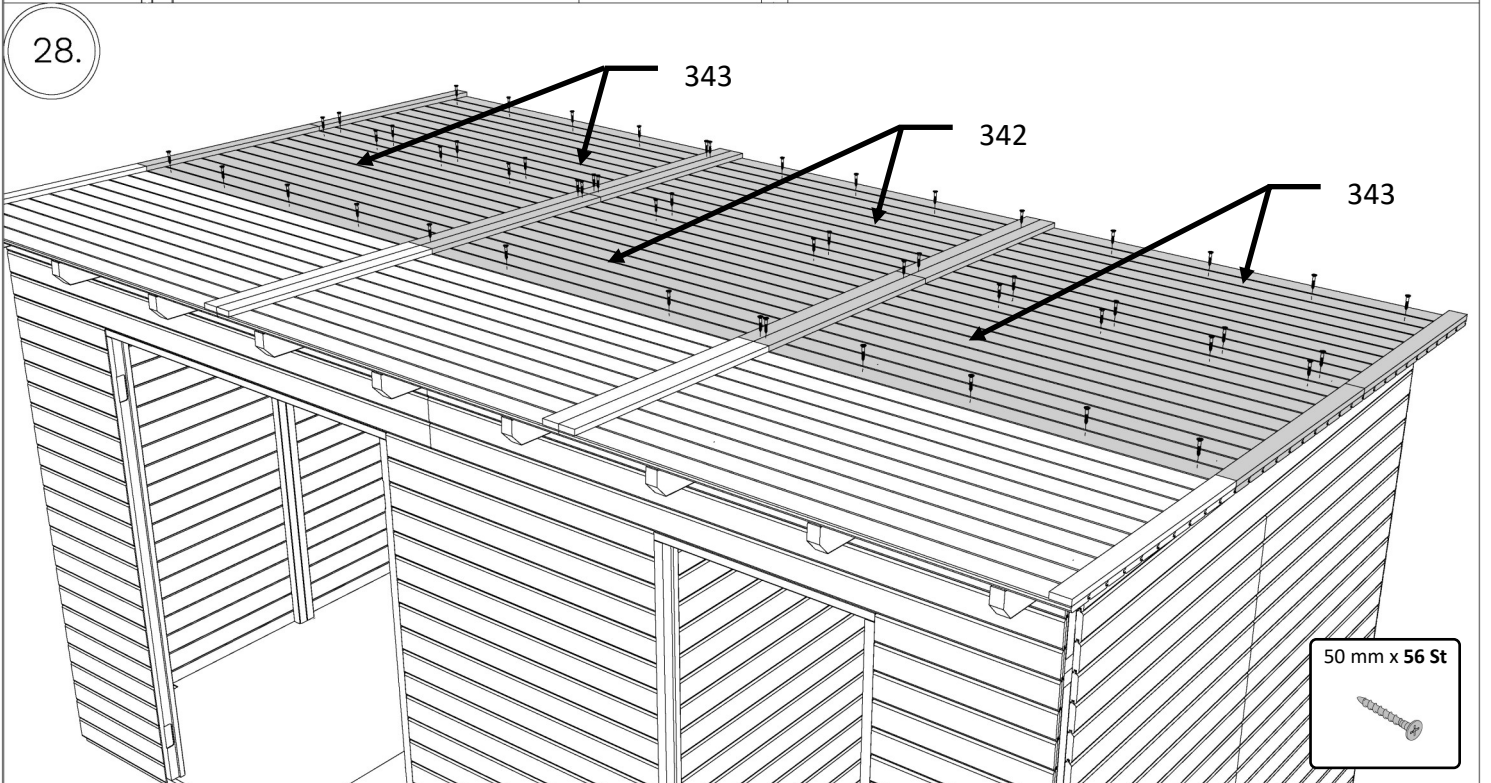
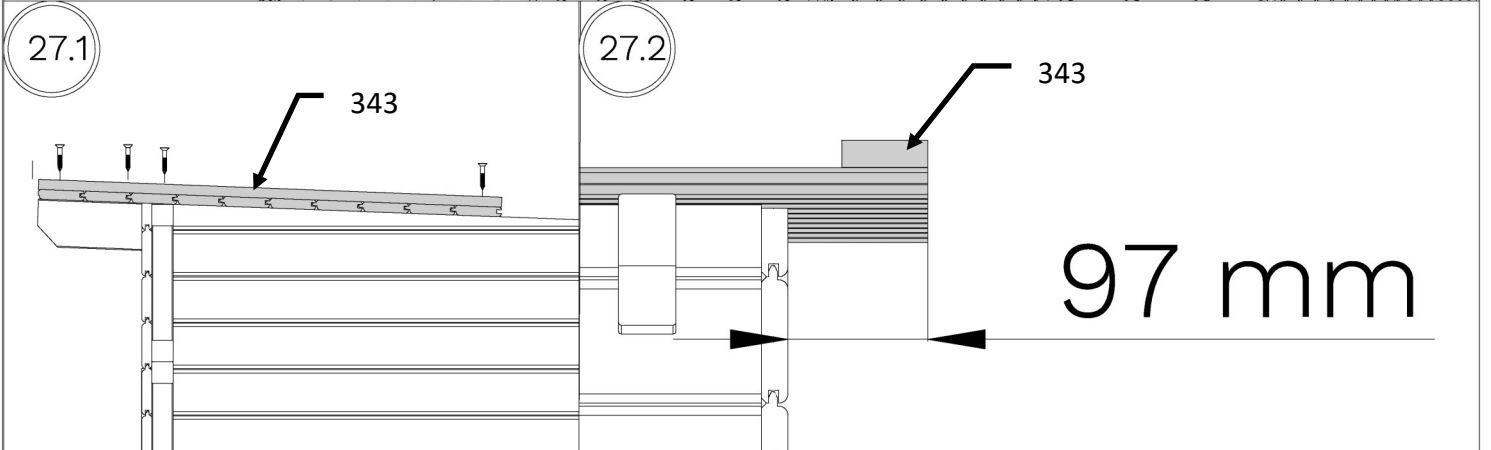
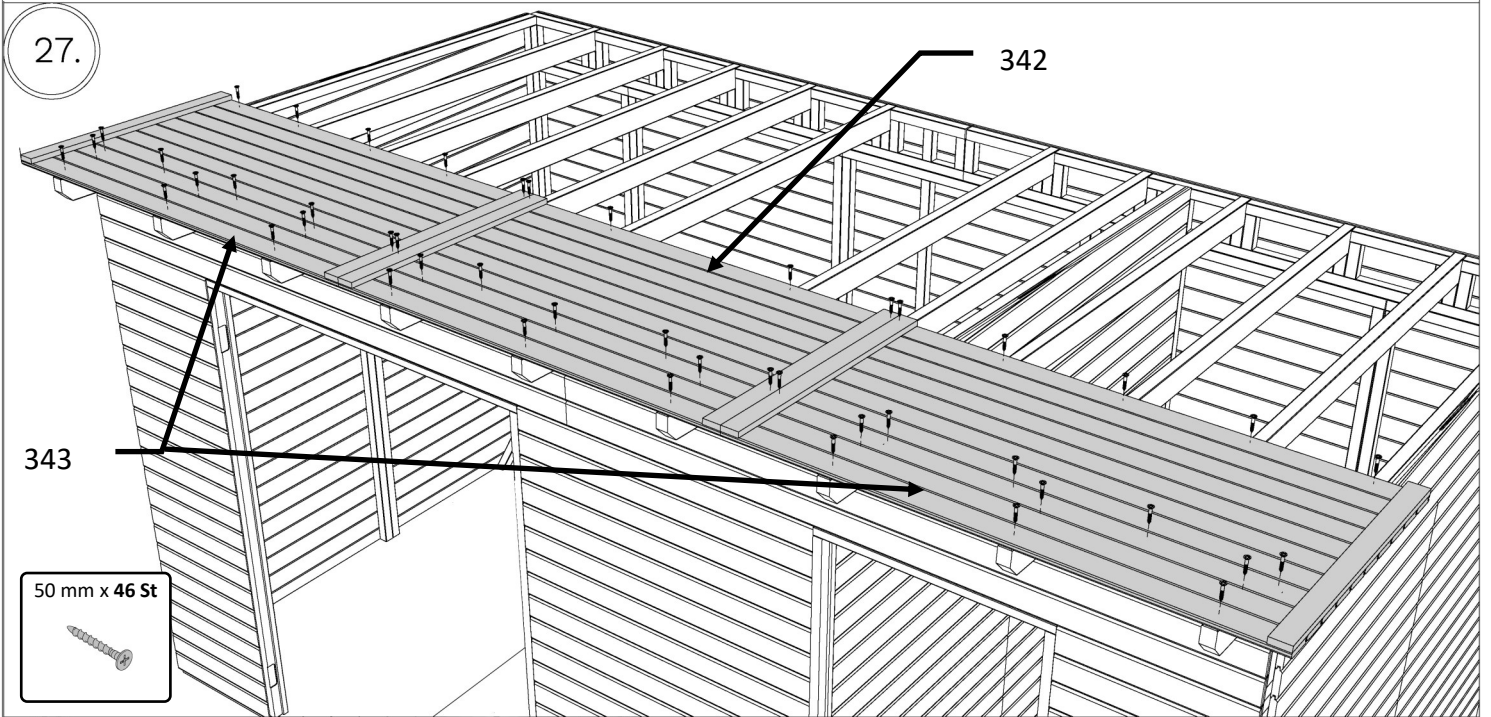



# BCLAI2(NF/GR)

29.

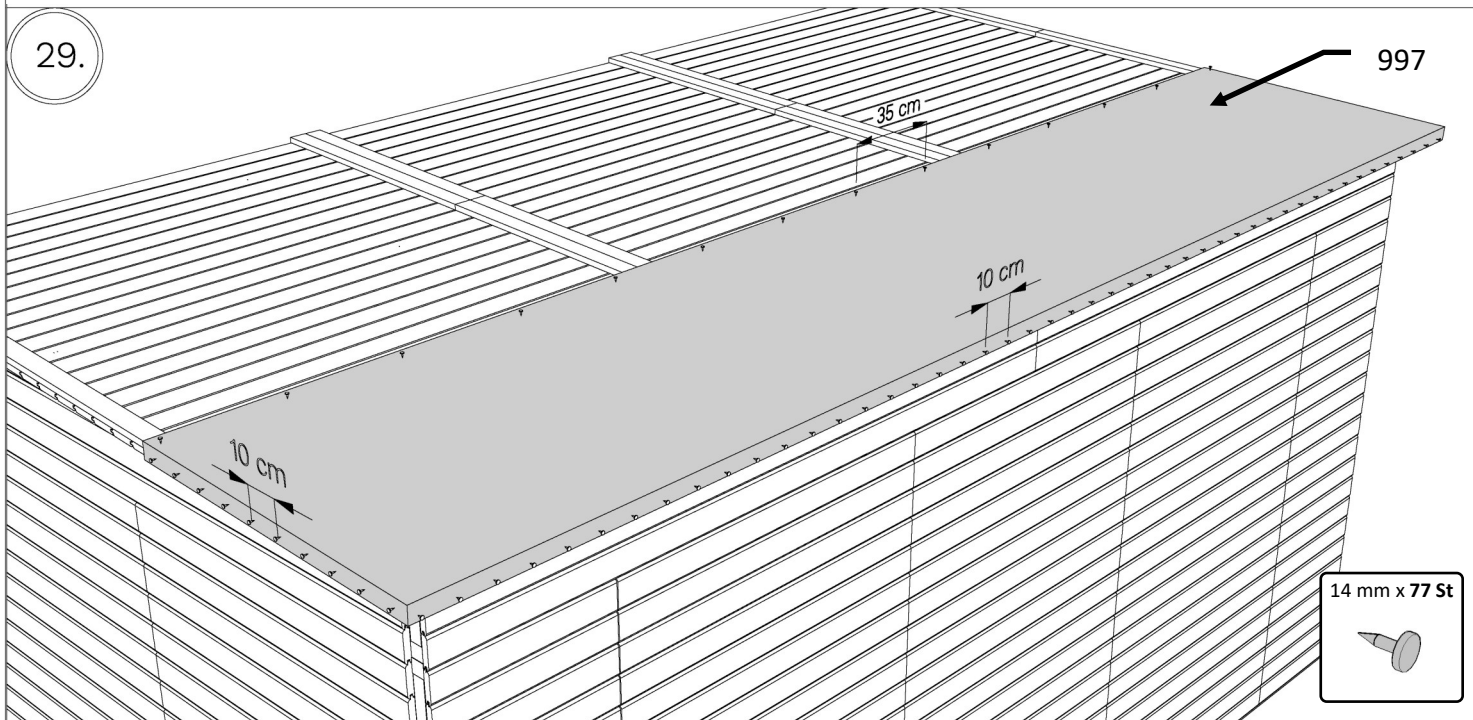

30.

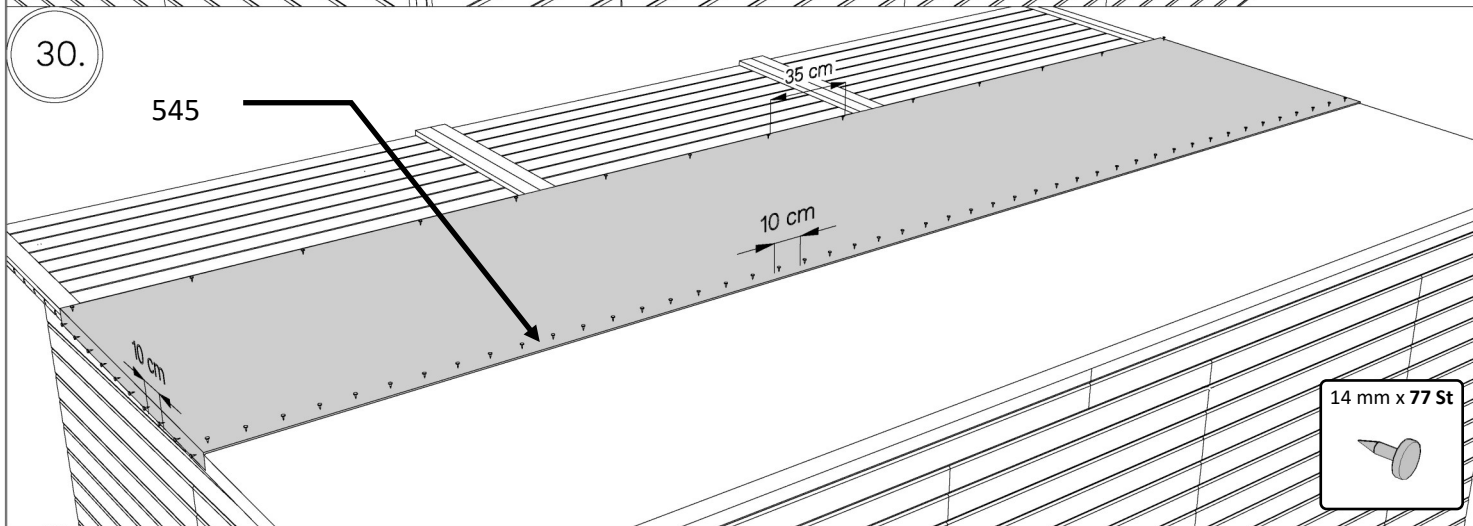

31.

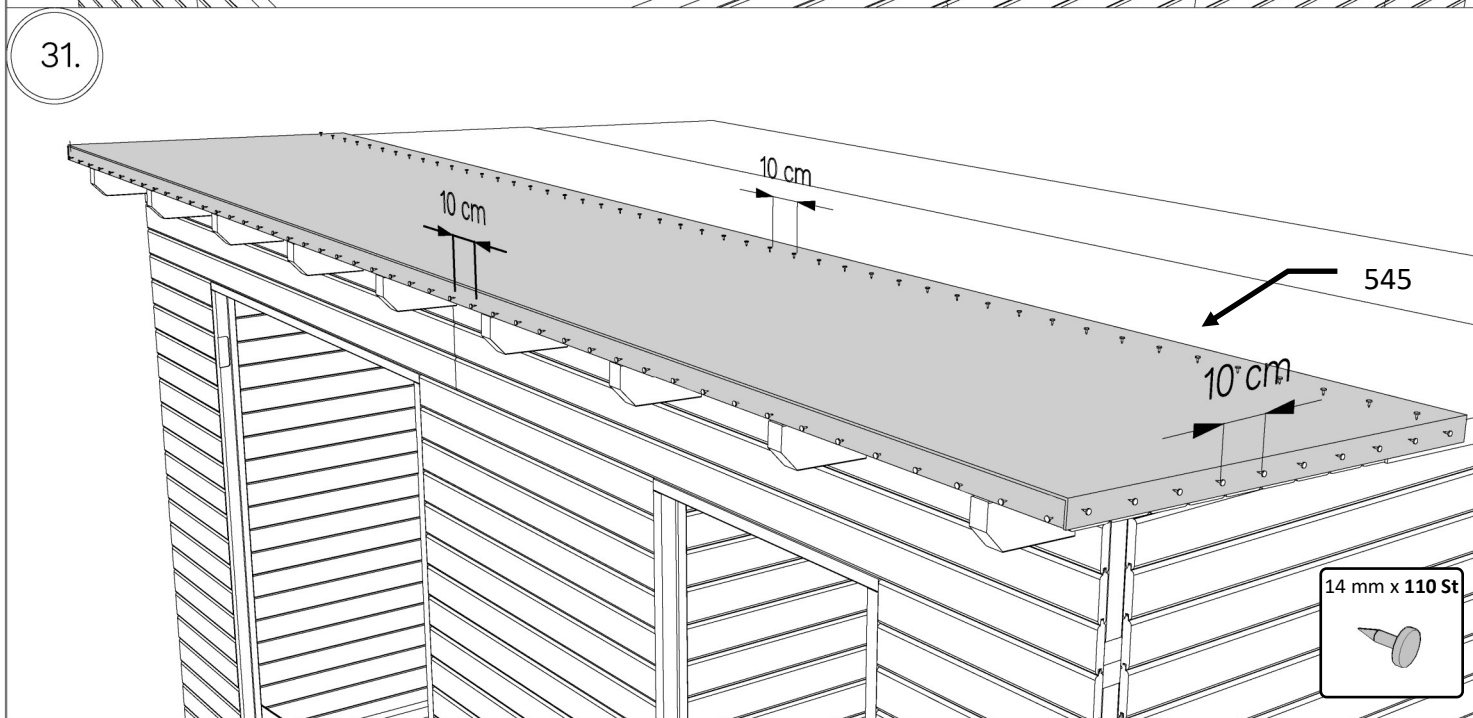

# BCLAI2(NF/GR)

32.

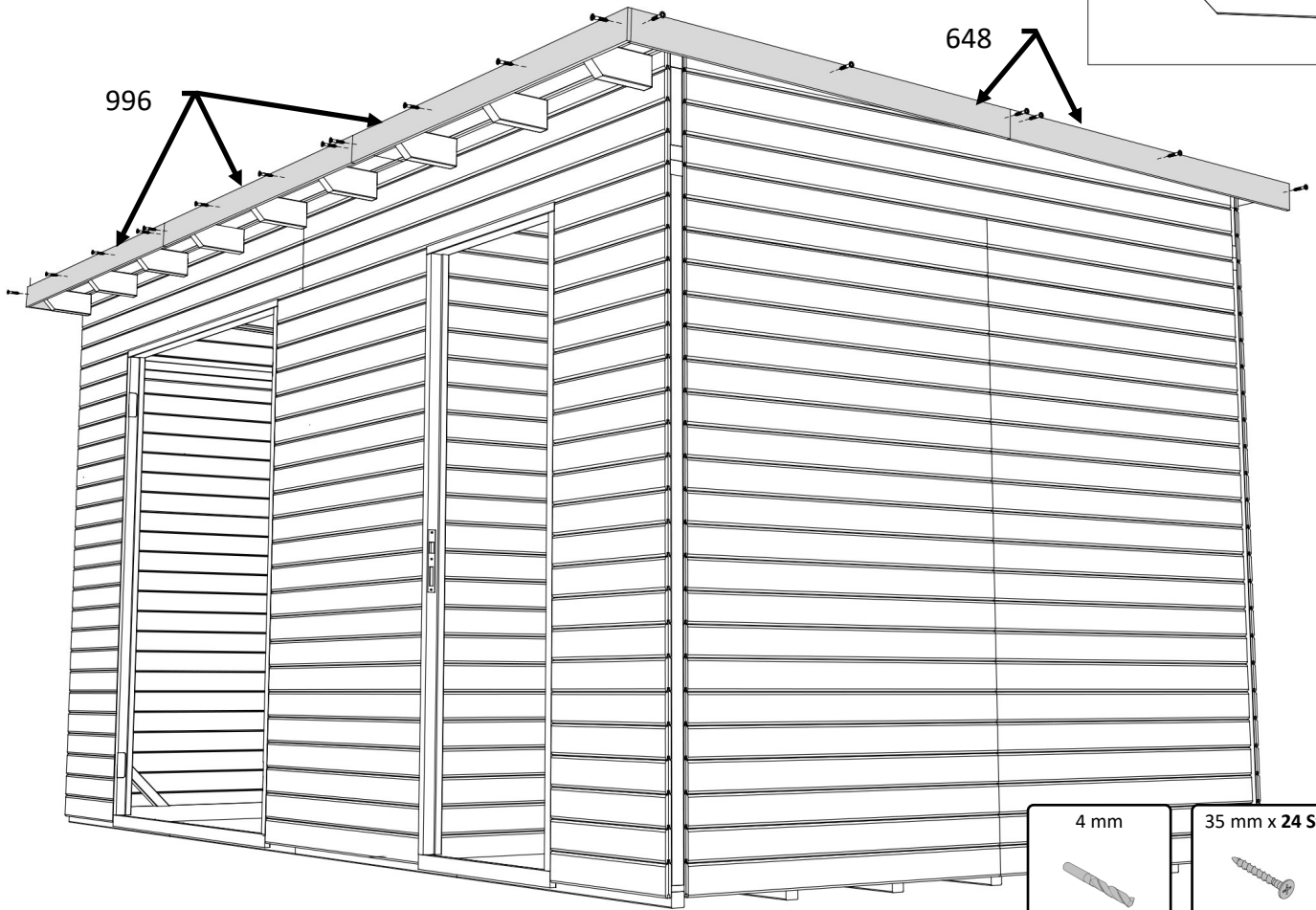

33.

628

**4X**

4 mm

35 mm x 2 St

34.

35 mm x 8 St

35.

35 mm x 8 St

756

756

# BCLA12(NF/GR)

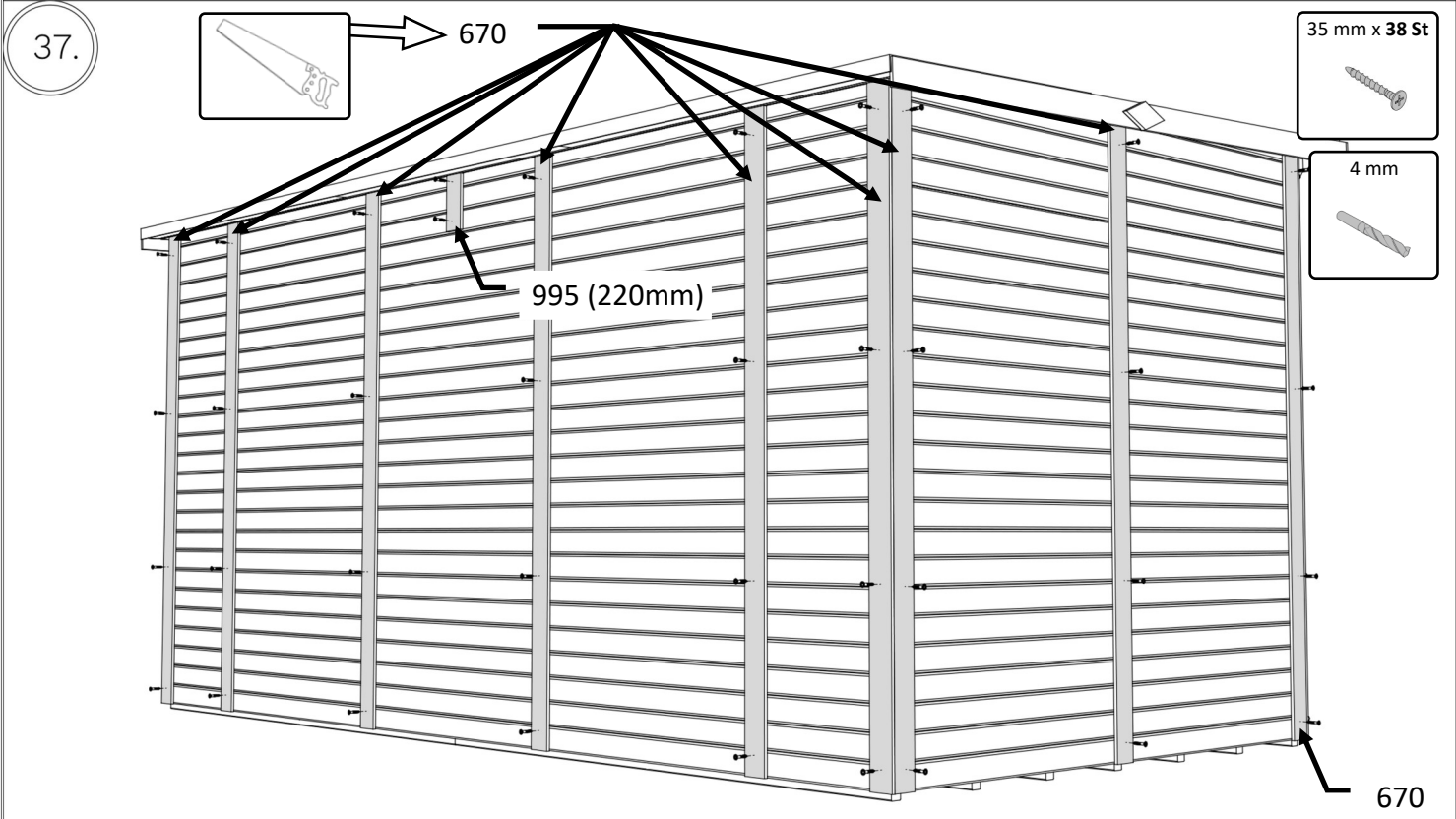
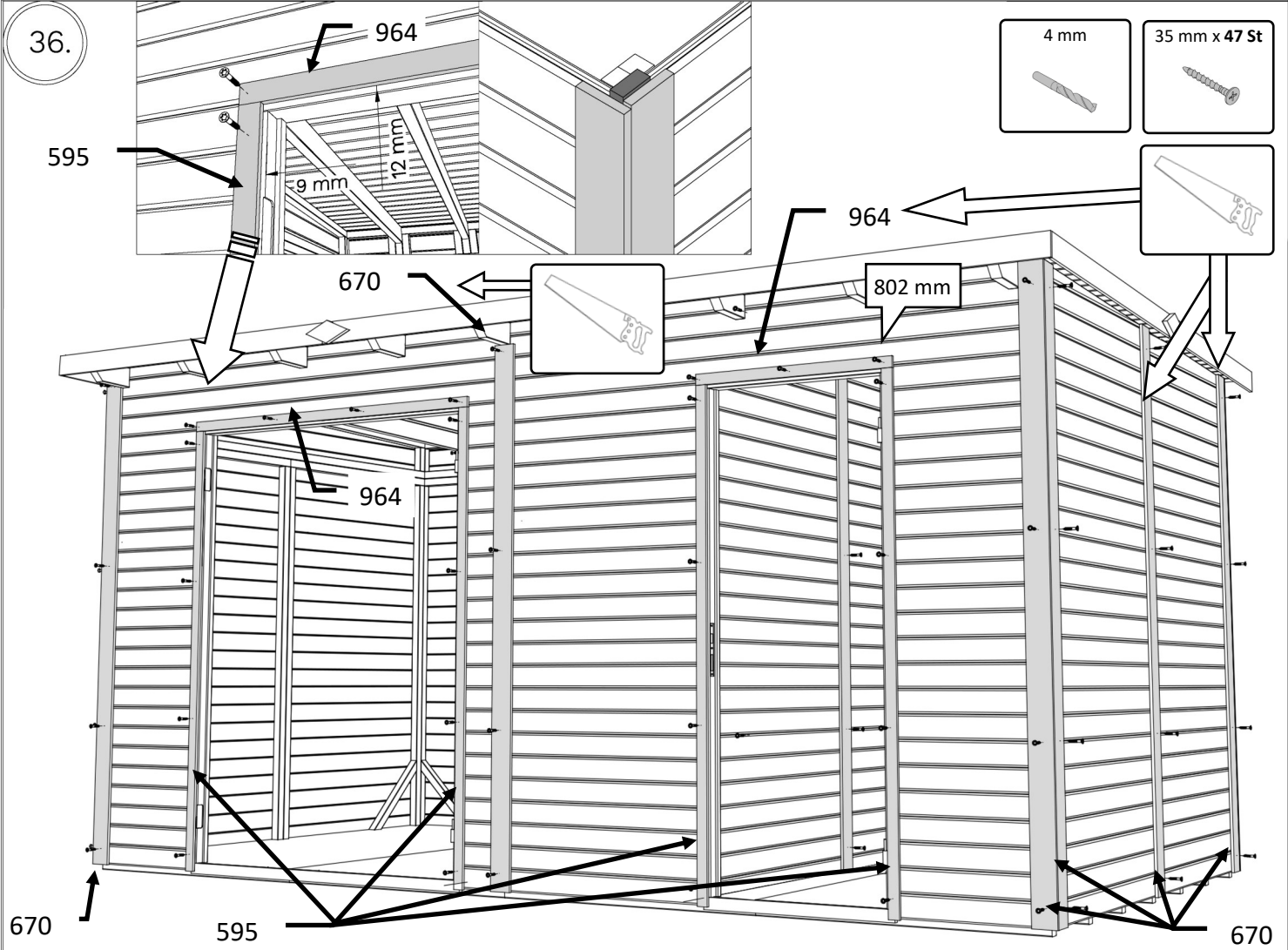

# NB! BCLAI2NF!!!!

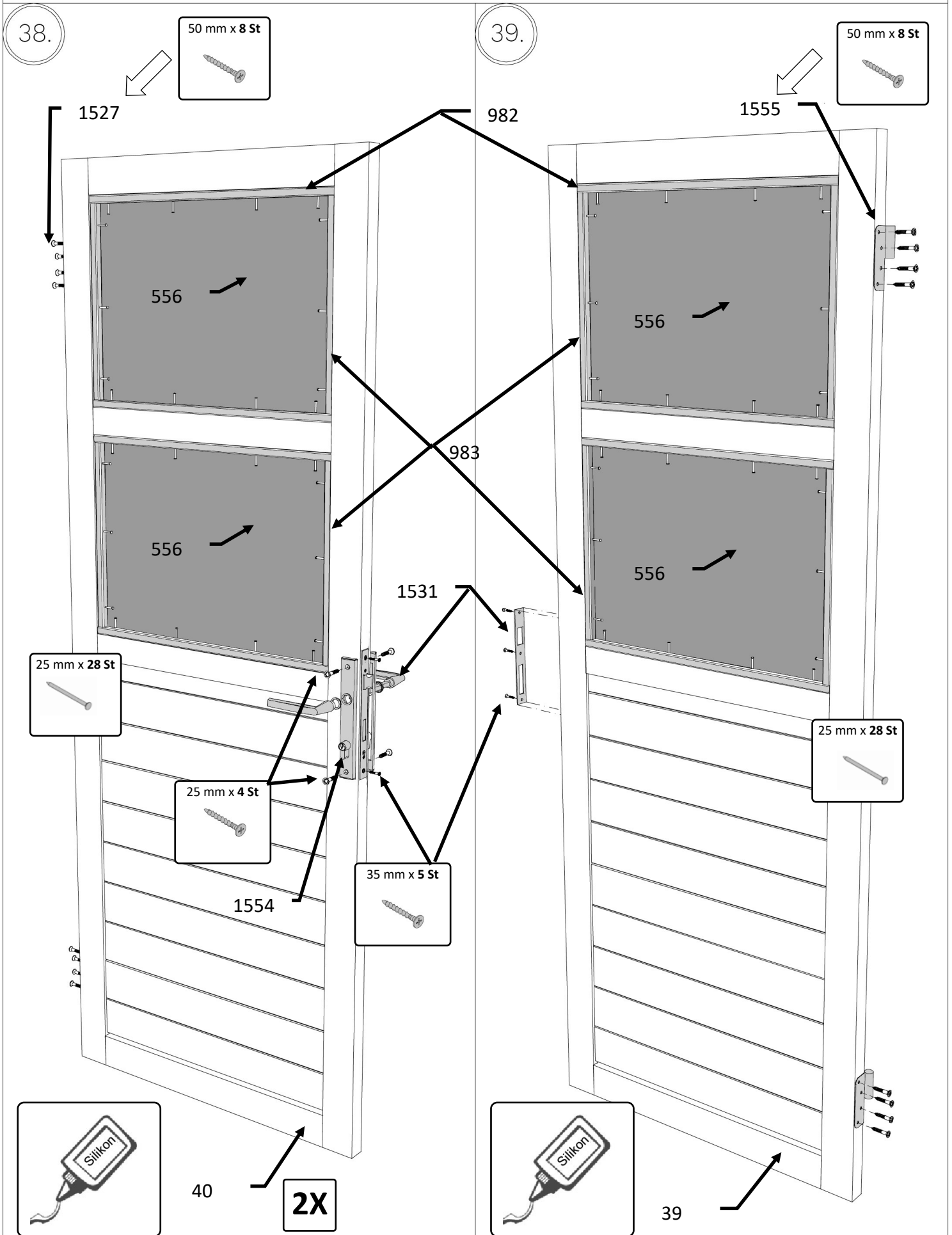

# NB! BCLAI2GR!!!!

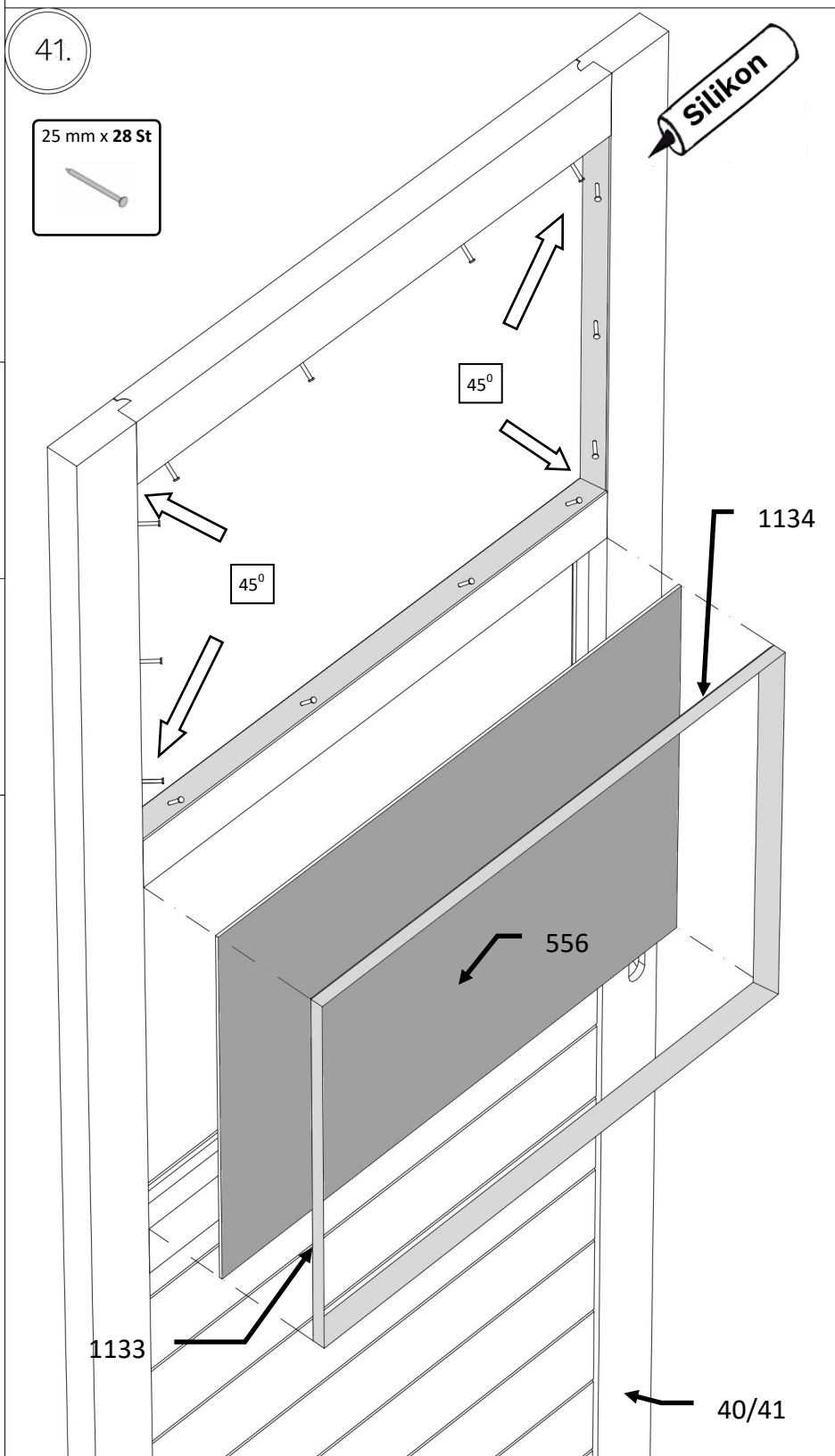
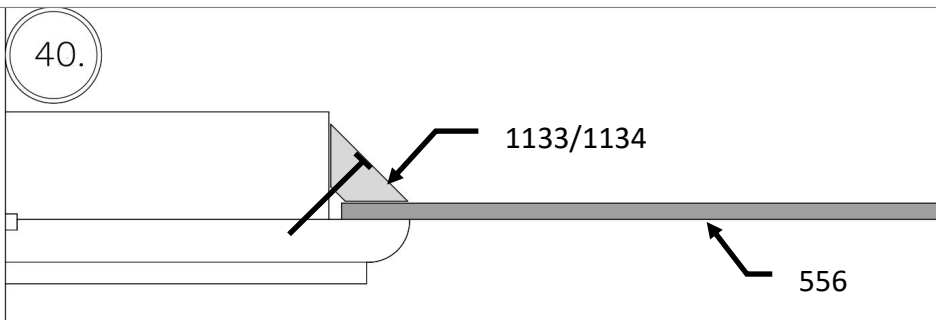
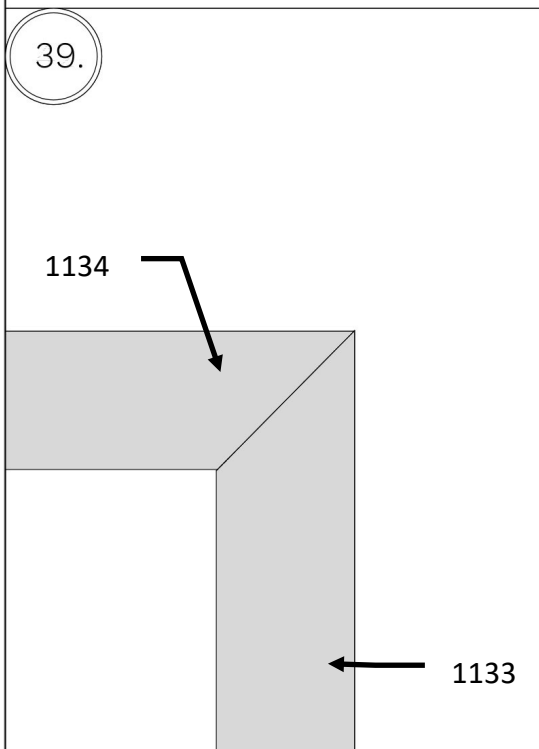
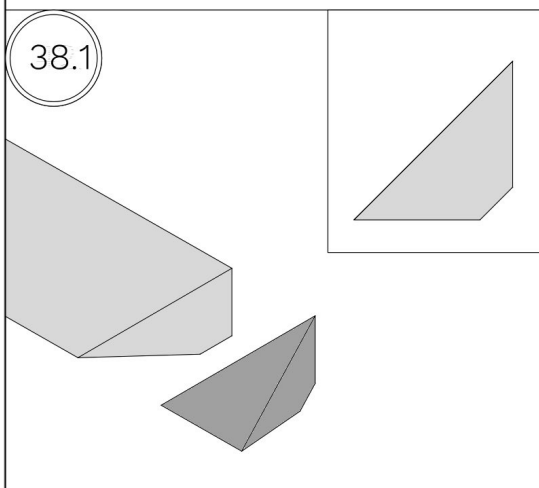
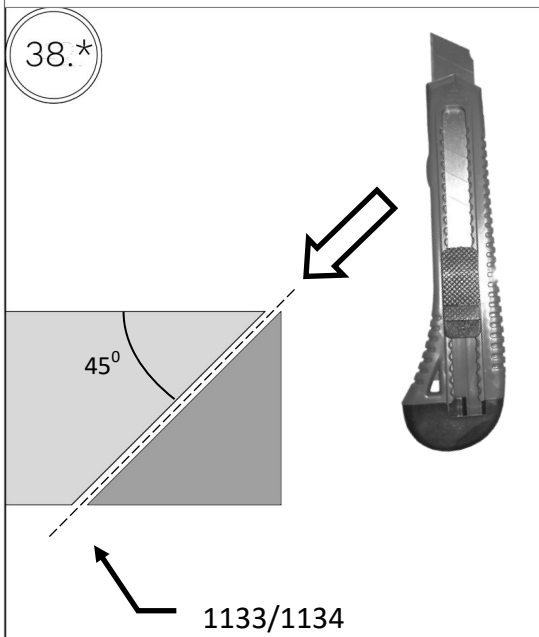

# BCLA12(NF/GR)

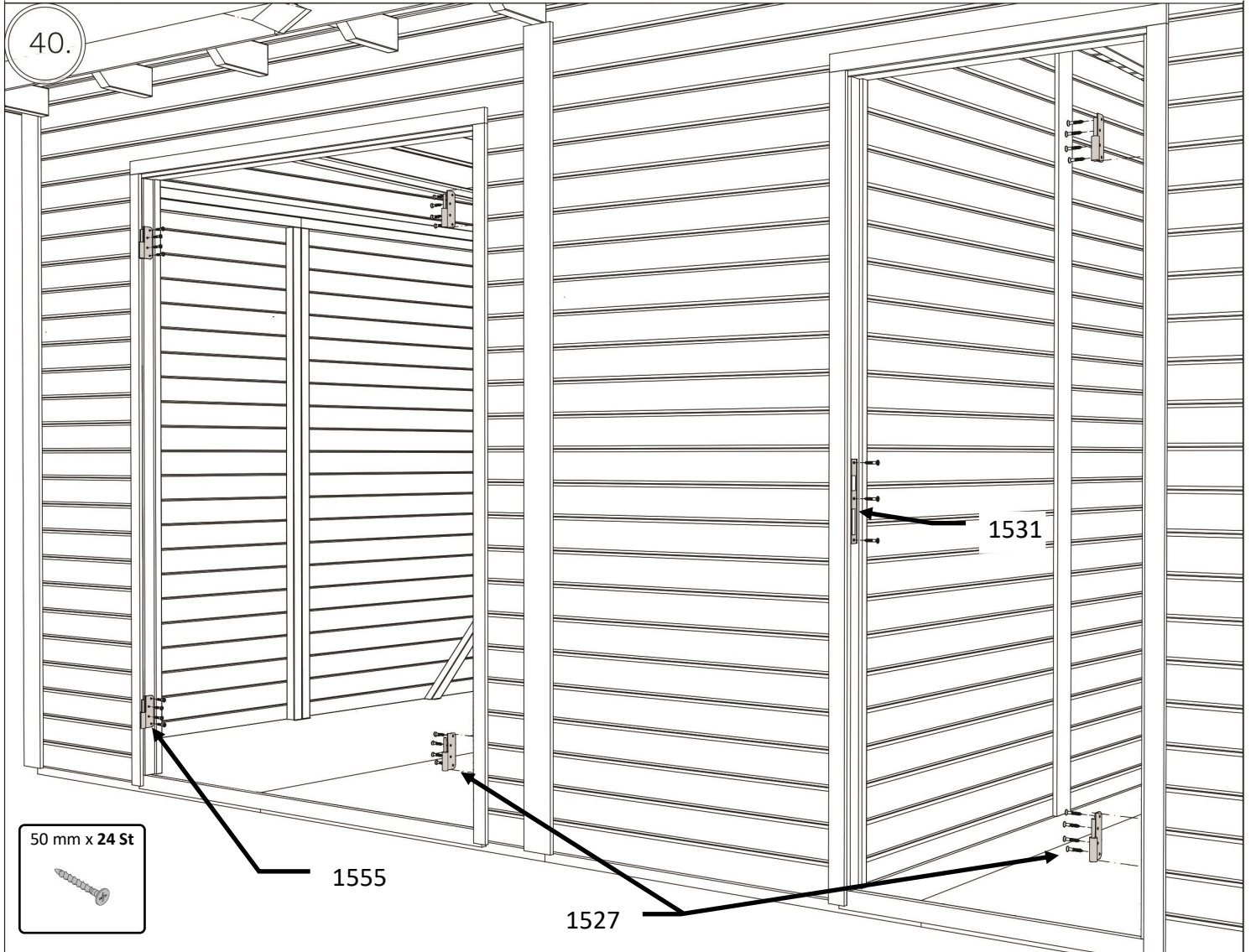

# BCLAI2(NF/GR)

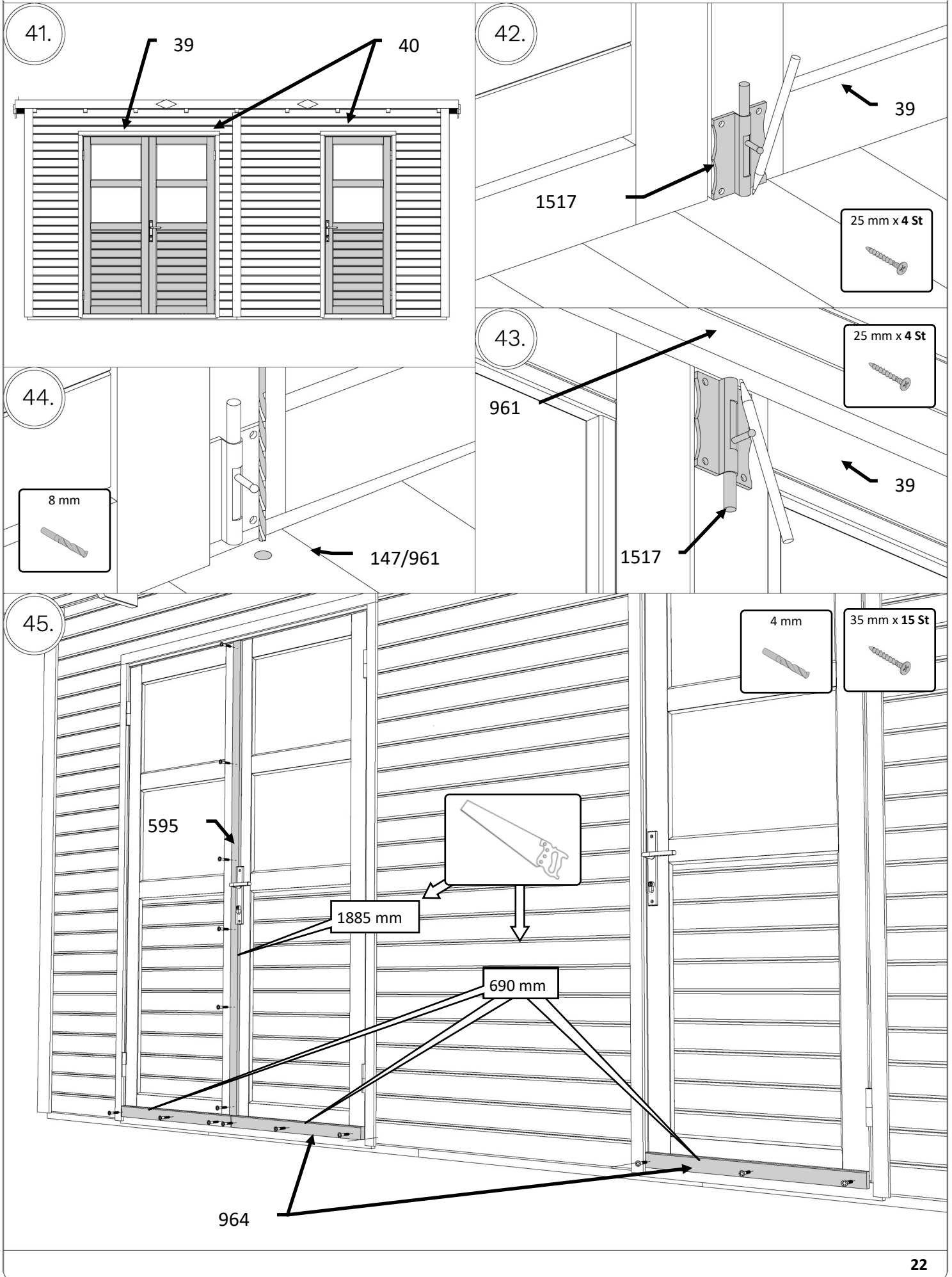

# BCLAI2(NF/GR)

Version 1.

1.

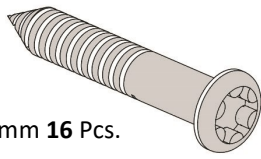

Ø3 x 19 mm 16 Pcs.

1557 4 Pcs.

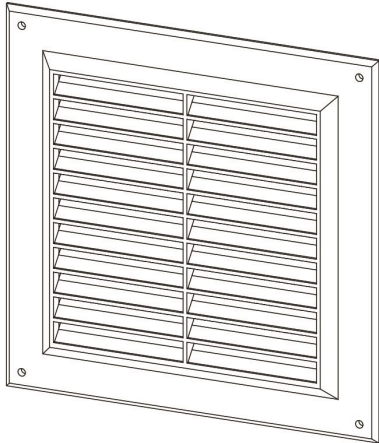

2.

2X

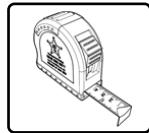
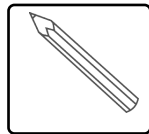
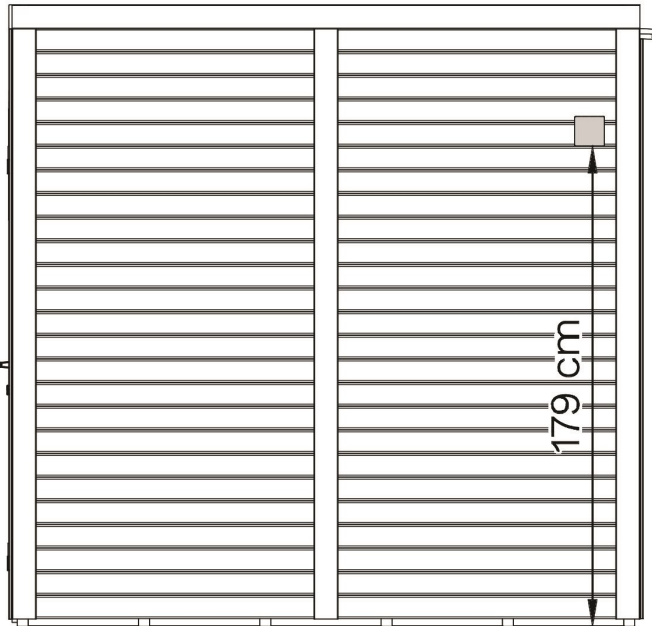

3.

8 mm



110 mm

110 mm

4.

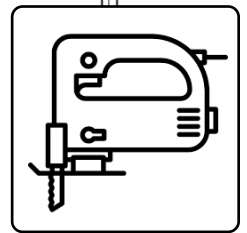

5.

Silikon



6.

19 mm x 4 St



19 mm x 4 St





# BCLAI2(NF/GR)

Version 2.

1.

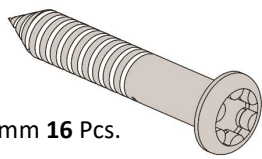

Ø3 x 19 mm 16 Pcs.

1557 4 Pcs.

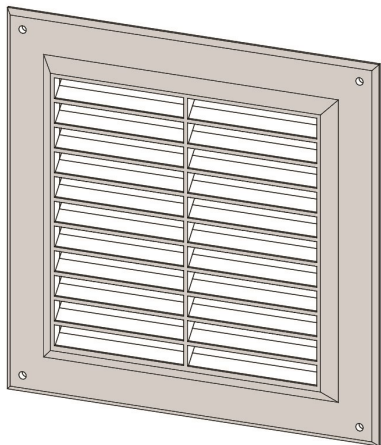

2.

2X

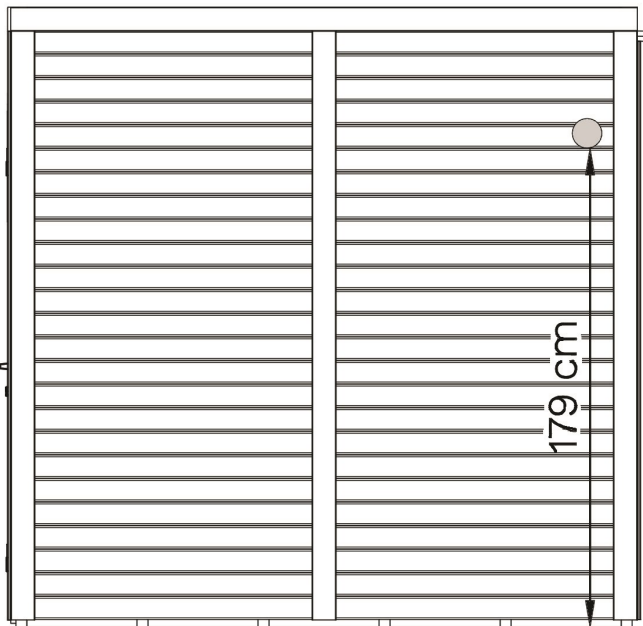
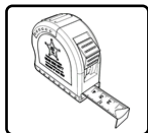
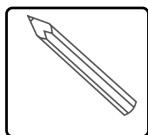

3.

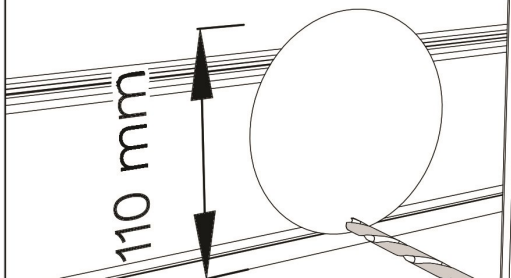
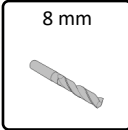

4.

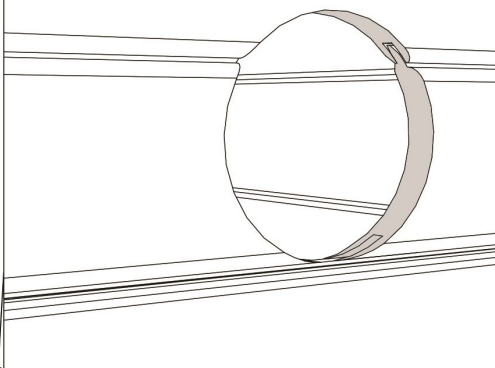
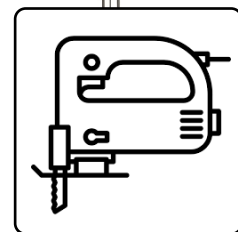

5.

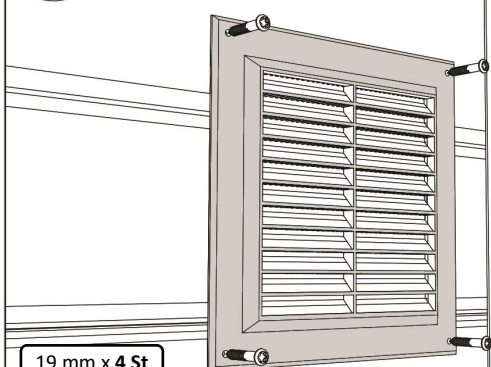

19 mm x 4 St



6.

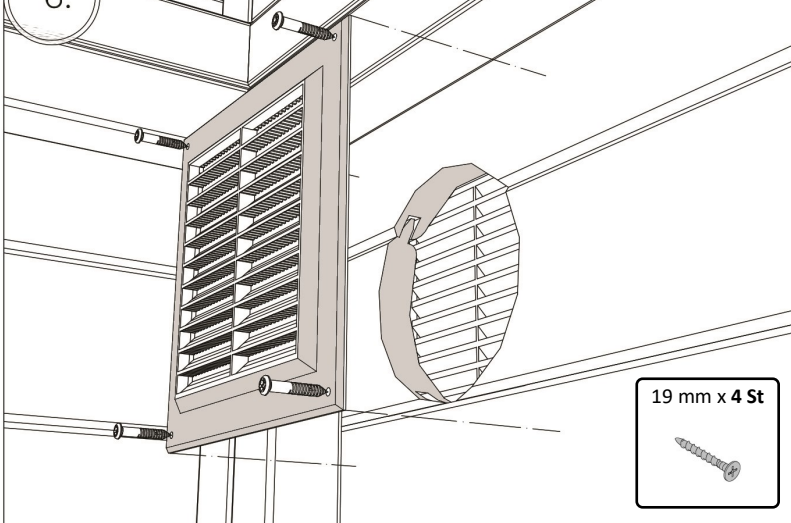

19 mm x 4 St

