

AKRÜÜLVANN A6-170-8109

Ülevoolu- ja põhjaveentiliga

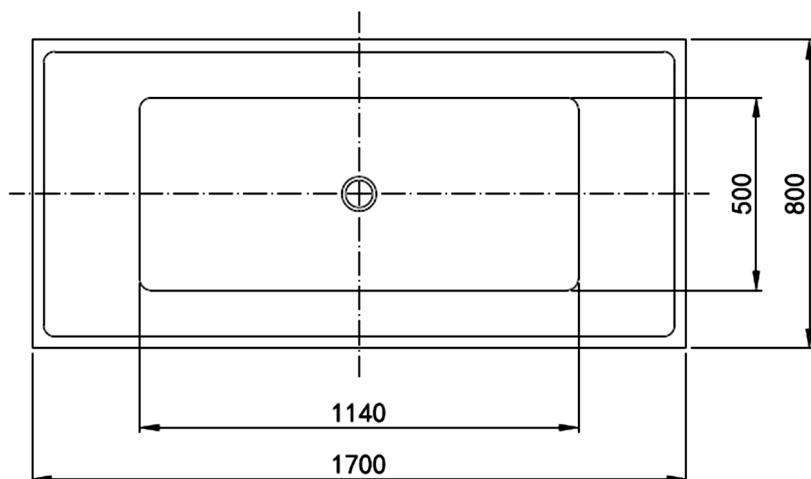
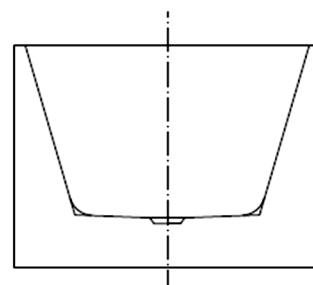
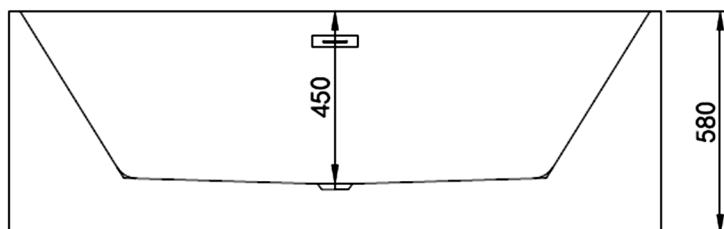

Pikkus	1700 mm
Laius	800 mm
Kõrgus	580 mm
Maht	285 l
Kaal	58 kg