

AKRÜÜLVANN A2-170-8113

Ülevoolu- ja põhjaveentiliga

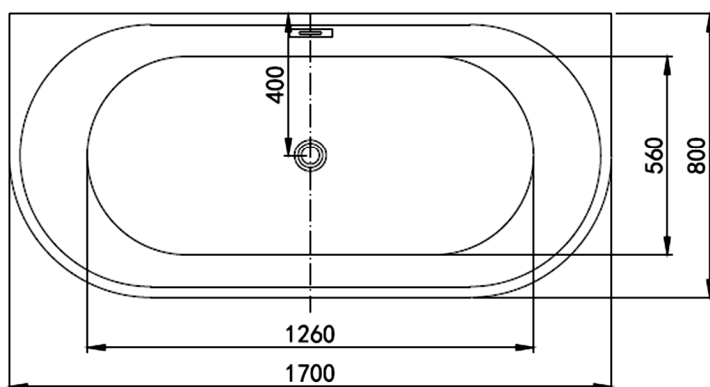
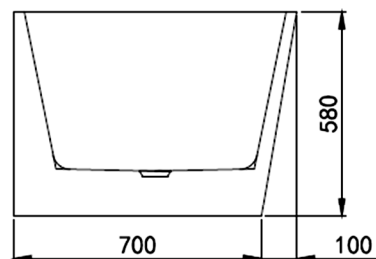
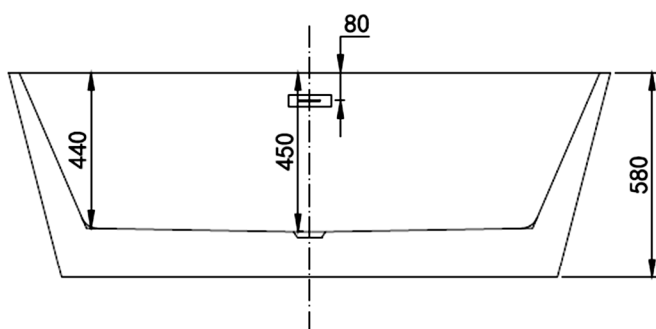

Pikkus	1700 mm
Laius	800 mm
Kõrgus	580 mm
Maht	300 l
Kaal	48 kg