

Technical Description

for

PORTABLE CABIN, SANITARY CABIN and CORRIDOR CABIN

Contents

1	General information	3
1.1	Dimensions (mm) and weights (kg):	3
1.2	Abbreviations	4
1.3	Standard configuration	4
1.4	Insulation	5
1.5	Load bearing capacity	6
1.5.1.	Standard load bearing capacity ^{1/2/3}	6
1.5.2.	Optional load bearing capacity (except CAH 2.591m and 30' cabins)	6
1.5.3.	Optional load capacities for corridor cabins (except CAH 2.591m and 30')	6
1.6	Basic principles of the static calculations	7
1.7	Sound insulation	7
2	Container design	8
2.1	Frame construction	8
2.2	Floor	8
2.3	Roof	9
2.4	Wall panels	10
2.5	Partition walls	11
2.6	Doors	11
2.7	Windows	12
3	Electrical installation	13
3.1	Technical data	13
3.2	Labelling of the electric (symbols)	15
3.3	Heating and air conditioning	15
4	Water installations	17
5	Design options	18
6	Paint	19

7	Certification	19
8	Miscellaneous	20
8.1	Transport.....	20
8.2	Handling.....	21
8.3	Installation / Assembly / Statics / Maintenance	22
9	Appendix.....	24
9.1	Arrangement options for 10', 16' and 20' containers, max. CAH 2.96m	24
9.2	Arrangement options for 24' and 30' ¹ containers, max. external height 2.96 m	25
9.3	Standard foundation plan for 10', 16' und 20' cabin (load capacities in accordance with 1.5.1.)	26
9.4	General foundation plan for 10', 16' and 20' containers with optional load capacities (in accordance with 1.5.2.).....	27
9.5	General foundation plan for 24' and 30' containers (in accordance with 1.5.1.)	28

1 General information

The following description refers to the specification and design of the new portable, sanitary and corridor cabins.

Our cabins match the ISO-norm dimensions and have therefore many advantages of that system. They consist of a robust frame construction and interchangeable wall panels.

The design of the CTX standard portable cabin is labelled with ¹, the CTX standard sanitary cabin with ² and the CTX corridor cabin with ³.

All design options which are not labelled with ¹ or ² or ³ are only delivered if they are listed in the written agreement.

1.1 Dimensions (mm) and weights (kg):

Type	External			Internal			Weight (approx. specifications)			
	Length	Width	Height	Length	Width	Height	BM	BU	SU	
10'	2,989	2,435	2,591	2,795	2,240	2,340	1,300	1,200	1,500	
			2,800			2,540				1,350
			2,960			2,700				1,400
16'	4,885	2,435	2,591	4,690	2,240	2,340	1,750	1,600		
			2,800			2,540				1,800
			2,960			2,700				1,850
20'	6,055	2,435	2,591	5,860	2,240	2,340	2,050	1,850	2,500	
			2,800			2,540				2,100
			2,960			2,700				2,150
24'	7,335	2,435	2,591	7,140	2,240	2,340	2,350	2,150		
			2,800			2,540				2,450
			2,960			2,700				2,550
30'	9,120	2,435	2,591	8,925	2,240	2,340	2,750	2,500		
			2,800			2,540				2,850
			2,960			2,700				2,950

* The mentioned dimensions and weights are valid for standard configuration (see 1.3.) and can vary depending on configuration and equipment.

1.2 Abbreviations

The following abbreviations are used in the document:

Portable cabin with mineral wool insulation	BM
Portable cabin with PU foam insulation	BU
Sanitary cabin with mineral wool insulation	SA
Sanitary cabin with PU foam insulation	SU
Corridor cabin	VC
Mineral wool	MW
Polyisocyanurate	PIR
Polyurethane foam	PU
Rock wool	SW
Internal height	RIH
External cabin height	CAH
Transpack (BM/BU in a package)	TP
Toughened safety glass	ESG
Laminated safety glass	VSG
Heat-strengthened glass	TVG

1.3 Standard configuration

Portable cabin 10'

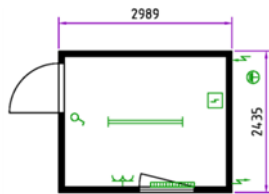

Portable cabin 16'

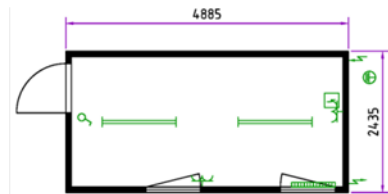

Portable cabin 20'

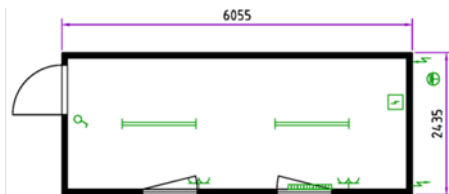

Portable cabin 24'



Portable cabin 30'

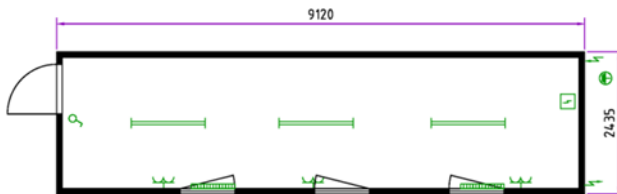

Sanitary cabin 10'

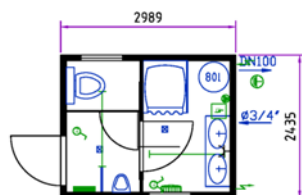

Sanitary cabin 20'

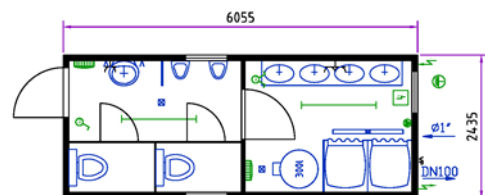

1.4 Insulation

Component	Insulating material	Thickness (mm)	U-value (W/m ² K)*
Roof			
	MW ^{1/2/3}	100	0.36
	MW	140	0.23
	PU	100	0.20
	PU	140	0.15
Wall element			
	MW ^{1/3}	60	0.57
	MW	100	0.35
	PU ²	60	0.38
	SW	60	0.65
	SW	110	0.35
	PIR	110	0.20
Floor			
	MW ^{1/2/3}	60	0.55
	MW	100	0.36
	PU	100	0.20

* The U-values apply to the stated insulation thickness in the space between the timber frames in a half-timbered construction (within the panel).

Window			U-value (W/m ² K)*
	Standard insulation glazing with gas filling ^{1/2/3}	4/16/4 mm	1.10
	3 pane insulation glazing with gas filling	4/8/4/8/4 mm	0.70

* The U-values relate to the Ug value (U-value of the glass) of the specified glazing.

External door			U-value (W/m ² K)*
1000	polystyrene	40 mm	1.80
875	polystyrene	40 mm	1.90

* The U-values relate to the Ud-value (U-value of the doors) of the specified construction width.

Insulation values according to EN ISO 10077-1 and EN ISO 10077-2 upon request!

1.5 Load bearing capacity

1.5.1. Standard load bearing capacity ^{1/2/3}

floor load:

ground floor: max. load capacity 2.0 kN/m² (200 kg/m²)

top floors: max. load capacity 1.5 kN/m² (150 kg/m²)

When using the double number of floor cross members, a maximum permissible payload of 4.0 kN/m² (400 kg/m²) is reached on the ground floor.

characteristic snow load on the floor:

with max. 2-storey installation * $S_k = 1.50 \text{ kN/m}^2$ (150 kg/m²)

*Shape parameters $\mu = 0.8$ ($s = \mu_1 * s_k = 1.2 \text{ kN/m}^2$ (120 kg/m²))*

with 3-storey installation $S_k = 1.25 \text{ kN/m}^2$ (125 kg/m²)

characteristic snow load on the ground $s_k = 1.25 \text{ kN/m}^2$ (125 kg/m²)

*Shape parameters $\mu = 0.8$ ($s = \mu_1 * s_k = 1.0 \text{ kN/m}^2$ (100 kg/m²))*

wind force v_b : with max. 2-storey installation *

$v_b = 27 \text{ m/s}$, [97.2 km/h] terrain category III

with 3-storey installation

$v_b = 25 \text{ m/s}$, [90 km/h] terrain category III

* except 24' and 30' portable and sanitary cabins

1.5.2. Optional load bearing capacity (except CAH 2.591m and 30' cabins)

floor load:

ground floor: max. load capacity 4.0 kN/m² (400 kg/m²)

top floors: max. load capacity 3.0 kN/m² (300 kg/m²)

snow load: characteristic snow load on the ground $s_k = 2.5 \text{ kN/m}^2$ (250 kg/m²)

*Shape parameters $\mu = 0.8$ ($s = \mu_1 * s_k = 2.0 \text{ kN/m}^2$ (200 kg/m²))*

wind force v_b $v_b = 25 \text{ m/s}$, [90 km/h] terrain category III

1.5.3. Optional load capacities for corridor cabins (except CAH 2.591m and 30')

floor load:

ground floor: max. load capacity 5.0 kN/m² (500 kg/m²)

top floors: max. load capacity 5.0 kN/m² (500 kg/m²)

snow load: characteristic snow load on the ground $s_k = 2.5 \text{ kN/m}^2$ (250 kg/m²)

*Shape parameters $\mu = 0.8$ ($s = \mu_1 * s_k = 2.0 \text{ kN/m}^2$ (200 kg/m²))*

wind force v_b $v_b = 25 \text{ m/s}$, [90 km/h] terrain category III

For wind speeds over 90 km/h [25 m/s], additional safeguards must be put in place for the cabins (bracing, screwing, etc.). These measures must be assessed by authorised professionals while taking into consideration the local norms and conditions.

The load capacities are only valid in accordance with the cabin configuration options (see 9.1./9.2.).

Other optional load bearings or site-specific earthquake safety measures are available on request.

1.6 Basic principles of the static calculations

exposed side	EN 1990 (Eurocode 0, basic principles)
	EN 1991-1-3 (Eurocode 1, snow)
	EN 1991-1-4 (Eurocode 1, wind)
non-exposed side	EN 1993-1-1 (Eurocode 3, steel)
	EN 1995-1-1 (Eurocode 5, wood)

National application documents and other special load cases (as e.g. seismic safety) are not considered explicitly and must be requested separately!

1.7 Sound insulation

Sound insulation values on request.

2 Container design

2.1 Frame construction

	BM/SA/VC-Container ^{1/2/3} (standard load capacities in accordance with 1.5.1.)	Portable and sanitary cabins (optional load bearing capacity 1.5.2.)	Corridor cabin (optional load bearing capacity 1.5.3.)
Floor frame	from cold rolled, welded steel profiles, four container corners welded		
Longitudinal floor frame	3 mm	4 mm	
Short end floor frame	3 mm		
Floor cross beam	made of Omega profiles, s = 2.5 mm		
Fork lift pockets	two fork lift pockets on the long side (except type 30' containers)		
	inside clearance of fork lift pockets: 352 x 85 mm		
	fork lift pocket distance in centre: 2.055 mm ^{1/2/3} optional: 1,660 mm* / 950 mm* / without fork lift pockets		
Corner posts	made from cold-rolled, welded steel profiles bolted to a floor and roof frame		
	4 mm	5 mm	
C column ³	3 mm	--	3 mm
Roof frame	from cold rolled, welded steel profiles, four container corners welded		
Longitudinal roof frame	3 mm	4 mm	
Short end roof frame	2.5 or 3 mm		
Roof cross members made of wood	---		
Cover	galvanised steel plate with double rabbet, thickness 0.6 mm		

* except 24' containers

2.2 Floor

insulation:

insulating material: **MW** ^{1/2/3}
fire behaviour A1 (non-flammable) according to EN 13501-1

PU
fire behaviour E in accordance with EN 13501-1

insulation thickness: 60 mm ^{1/2/3} / 100 mm

subfloor: **MW** ^{1/2/3}
0.6 mm thick, galvanised sheet
(various steel sheets according to production)

PU
Aluminium cover

floor:

floor plates: **Cement-bound chipboard**^{1/2/3} - thickness 20 mm
E1 in accordance with EN 13986:2004,
fire behaviour B-s1, d0 according to EN 13501-1

Plywood board - thickness 21 mm
E1 in accordance with EN 636:2012
fire behaviour D-s2, d0 or Dfl-s1 according to EN 13501-1

Chipboard - thickness 22 mm
E1 in accordance with EN 312:2003
fire behaviour D-s2, d0 or Dfl-s1 according to EN 13501-1

Floor cover:	vinyl floor cover welded in sheets in the sanitary area ² or pulled up on request					according to Standard ...	aluminium chequered plate
	Imperial Classic <small>1/3</small>	Sureste p ²	Accord	Eternal	Safestep		
total thickness	1,5 mm	2,0 mm	2,0 mm	2,0 mm	2,0 mm	EN ISO 24346	2 + 0,5 mm
wear layer	homogeneous	0,7 mm	homogeneous	0,7 mm	0,7 mm	EN ISO 24340	---
reaction to fire	B _{fl} -s1	B _{fl} -s1	B _{fl} -s1	B _{fl} -s1	B _{fl} -s1	EN 13501-1	---
slip resistance	R 9	R 10	R 9	R 10	R 11	DIN 51130	---
	---	C	---	---	B	DIN 51097	---
classification service class	23 / 31	34 / 43	34 / 43	34 / 43	34 / 43	EN ISO 10874	---
electrostatic behaviour	≤ 2 kV	≤ 2 kV	≤ 2 kV	≤ 2 kV	≤ 2 kV	EN 1815	---

2.3 Roof

insulation:

insulating material: **MW**^{1/2/3}
fire behaviour A1 (non-flammable) in accordance to EN 13501-1

PU
fire behaviour E in accordance with EN 13501-1

insulation thickness: 100 mm^{1/2/3} / 140 mm

ceiling sheeting:

coated chipboard^{1/3}
10 mm thick, white,
E1 in accordance to EN 312,
flame behaviour D-s2, d0 according to EN 13501-1

plasterboard with coated steel plate²
10mm thick, colour: white (similar RAL 9010)
flame behaviour A2-s1,d0 according to EN 13501-1

CEE connectors: externally sunk into short sided container frame

2.4 Wall panels

wall thickness 60² / 70^{1/3} / 110 mm (depending on insulating material)

available items: - full
- door
- window
- air conditioning
- sanitary window
- half
- double (only with windows or doors)
- fixed glazing
- rest panel

external cladding: corrugated, galvanised and coated steel sheet, thickness 0.6 mm

insulating material: **MW**^{1/3}
fire behaviour A1 (not flammable) according to EN 13501-1

PU²
flame behaviour B-s3, d0 according to EN 13501-1

PIR
fire performance B-s2, d0 according to EN 13501-1

SW
fire behaviour A2-s1, d0 according to EN 13501-1

insulation thickness: 60 mm^{1/2/3} / 100 mm / 110 mm

internal cladding: **coated chipboard**^{1/3}
thickness 10 mm, light oak^{1/3} / white.
E1 in accordance to EN 312,
fire behaviour D-s2, d0 respectively Dfl-s1 in accordance to EN13 501-1

plasterboard with coated steel plate
thickness 10 mm, colour: white (similar RAL 9010)
flame behaviour A2-s1,d0 s1 in accordance to EN 13501-1

galvanised steel sheet²
thickness 0.5 mm, décor: white

Wall panels - design combinations:

insulating material	panel thickness	external cladding	insulation thickness	internal cladding
MW	70 / 110	steel sheet	60 / 100	- coated chipboard - plasterboard with coated steel plate
PU	60		60	steel sheet
PIR	110		110	steel sheet
SW	60 / 110		60 / 110	steel sheet

2.5 Partition walls

available items: - full panel
- door panel
- window panel

wooden construction ^{1/3}: total thickness 60 mm

frame: wooden frame, thickness 40 mm

cladding on both sides: double-sided coated chipboard
10 mm thick, light oak / white
E1 in accordance to EN 312,
fire behaviour D-s2, d0 Dfl-s1 in accordance to EN13 501-1

sheet metal design ²: total thickness 60 mm

frame: wooden frame with cardboard comb, thickness 60 mm

cladding on both sides: laminated steel plate, thickness 0.5 mm, colour: white (similar RAL 9010)

2.6 Doors

- design according to DIN regulations
- right or left hand hinged
- inward or outward opening
- steel frame with triangular wrap-around sealing
- door blade with galvanised steel sheets on both sides

dimensions:	nominal dimension	clear opening
	625 x 2,000 mm (only as internal and/or WC door)	561 x 1,940 mm
	875 x 2,125 mm ^{1/2}	811 x 2,065 mm
	1,000 x 2,125 mm	936 x 2,065 mm
	2,000 x 2,125 mm	1,936 x 2,065 mm
	inactive leaf with concealed frame joint	

- optional:
- anti-panic push bar (according to EN 1125)
 - door grille with security fittings (for modular dimensions 875 x 2,125 mm)
 - twin frame
 - door closer
 - insulated glazing: W x H = 238 x 1,108 mm (ESG)
550 x 1,108 mm (ESG)
550 x 450 mm (ESG)

2.7 Windows

designwindow:

- pvc frame with insulated glazing and integrated pvc roller shutters; colour: white
- roller shutter housing with belt take-up reel and forced ventilations: housing height 145 mm, lamella colour light grey
- one hand tilt & turn mechanism
- incl. gas filling

ATTENTION: The built-in insulation glass is only suitable for use at altitudes up to 1,100 m above sea level. Above 1,100 m sea level windows with a pressure compensating valve need to be used.

	<i>window options:</i>	<i>external dimension</i>
standard window:	office window ¹	945 x 1,200 mm
	sanitary window ² (opaque windows)	652 x 714 mm
optional windows:	fixed glazing (ESG)	945 x 1,345 mm
	fixed glazing (ESG) *	945 x 2,040 mm (CAH 2,591 mm)
	fixed glazing (ESG) *	945 x 2,250 mm (CAH 2,800 mm und 2,960 mm)
	fixed glazing (ESG)	1,970 x 1,345 mm
	fixed glazing with sliding part (ESG)	945 x 1,200 mm
	windows with pass-through / speak-through	945 x 1,200 mm
	Office window XL	1,970 x 1,200 mm
	Double window	1,970 x 1,200 mm
	double sliding window	1,970 x 1,200 mm
	nursery window (VSG)	945 x 1,555 mm
	IP glazing (ESG)	miscellaneous

window parapet:

(vertical distance between floor level and the upper edge of the lower profile of the window frame)

office window (CAH 2,591 mm)	870 mm ¹
office window (CAH 2,800 mm, 2,960 mm)	1,030 mm ¹
optional CAH 2,800 and 2,960 mm)	870 mm
sanitary window	1,525 mm ²
nursery window	624 mm

- optional:
- Window grille (office and sanitary windows)
 - ventilation slider inside roller shutter housing
 - security glazing with office windows
 - foamed aluminium roller shutters with chain tension cords and roller shutter rails
 - insulated roller shutter box
 - ESG / VSG / TVG

3 Electrical installation

Specification: concealed cabling

IP20 ^{1/3}/IP44 ²

plug insert according to country standards (VDE, CH, GB, FR, CZ/SK, DK, IT)

country specific design / variations possible

3.1 Technical data

	basis VDE (= OEVE, SKAN, NO, CZ/SK, IT) ^{1/2/3}	FR	GB	CH, DK
connection:	recessed CEE external plug and socket connections			
voltage:	230V/3 poles/4 poles*/ 32 A ^{1/2/3}			
	400V/5 poles/ 32 A ^{1/2/3}			
frequency:	50 Hz			
protection:	residual current operated device 40 A/0,03 A ^{1/2/3} , 4 poles (400 V)			
	residual current operated device 63 A/0,03 A ^{1/2/3} , 2 poles (230 V)			
distribution board:	distribution box, surface mounted type, single/twin row ^{1/3**}			
	distribution box, surface mounted type, single/twin row wet room ^{2***}			
cable:	(N)YM-J / H05 VV-F	RO2V	(N)YM-J / H05 VV-F	
electrical circuits:	light	circuit breaker **** 10 A, 2 poles, 3x1,5 mm ² ^{1/2/3}		
	heating	circuit breaker **** 13 A, 2 poles		
		3 x 1,5 mm ² resp. 3 x 2,5 mm ² ^{1/2} cable- and country-specific		
	socket	circuit breaker**** 13 A, 2 poles		circuit breaker **** 10A, 2 poles
3 x 1,5 mm ² resp. 3 x 2,5 mm ² ^{1/2} cable- and country-specific		3x1,5 mm ²		
socket:	2 earthed twin wall sockets ¹ (portable cabin 20') 3 single sockets ² (sanitary cabin 20')			
lighting:	light switch ^{1/2}			
	2 twin batten fluorescent light tubes with plastic covering 2 x 36 W ¹ (portable cabin 20')			
	2 single light with trough and fluorescent tube 1 x 36 W ² (sanitary cabin 20')			

* only with NO electrics

** mounting on ceiling

*** mounting on wall or ceiling

**** LC-release switch characteristic C

optional: - category 2 light fittings 2 x 36 W / 2 x 58 W
- light with bulb 25 W
- spur

compliance with the following CENELEC regulations regarding protection against electric shock and protection against overload and short circuit

- HD 60364-1:2008
- HD 60364-4-441:2007
- HD 60364-7-717:2004
- HD 60364-7-701:2007
- HD 384.4.482 S1:1997
- HD 384.7.711 S1:2003

earthing: Universally usable grounding terminal:

On both short sides in the floor frame of each corner a drill hole with a diameter of 9.4 mm is prepared for the fixture of the grounding terminal.

- The fitting of the grounding terminal is undertaken with a screw M10 with a self-cutting screw thread. The positioning of the screw is carried out in the factory on a suitable spot of the cabin.
- A grounding terminal and a four-wire connector are delivered with the container and need to be fitted by the customer on site.
- The protective earthing of the container must be carried out by the customer at the installation site.
- The effectiveness of the grounding connection of the cabin must be verified by an electrician in the course of an electrical check prior to commissioning

lightning and overvoltage protection

The required measures for the outer and inner lightning protection (grounding measures, overvoltage protection devices) for the devices operated in the cabin for the installation site and their sensitivity must be observed and be established if necessary.

- wiring:
- Fixed cabling depending on the panel configuration and the user ^{1/2/3}
 - Flexible cable system with plug contact and cables in full length

safety advice: The cabins can be linked electrically at the external CEE plugs and sockets. For the decision how many units to connect electrically the expected constant current in the link circuits has to be considered. The commissioning has to be carried out by an approved electrician.

The manual for the assembly, start up, utilisation and maintenance of the electrical installations is delivered in the fuse box and needs to be followed!

Before connecting the cabin to the supplying low voltage grid all appliances (consumer loads) need to be switched off and earthing needs to be ensured (earthing feed cable and earthing connecting lines between the cabins need to be checked on potential equity and low Ohm level).

Attention: The supply- and connection cables are made for an operating voltage of max. 32 Ampere. These aren't secured with a overcurrent protection device. The connection of the cabins to the external electrical power supply only may be undertaken by an authorised specialist company.

Before using the cabin (modular building) for the first time the effectiveness of the protection measures for the fault protection need to be checked by an authorised specialist company.







Attention: The commissioning of the boilers and/or under table units is only permitted when they are filled!

Cleaning with a high-pressure cleaner is FORBIDDEN.

The electrical equipment of the cabin may not be cleaned by a direct water jet under any circumstances.

- If the containers are delivered into areas with increased lightning activity further measurements have to be taken under account to prevent overvoltage depending on the country specific rules.
- In case machines or appliances with high starting current peaks are used (according to the manual of the respective appliances) adequate RCD/MCB must be used.
- The electric fittings of the cabins are designed for minimal vibration exposure. When higher loads are given, appropriate measures must be taken according to the national technical regulations (and/or checks of the plug or screw contacts).
- The cabins are designed for areas with little seismic activity. If the cabins are used in areas with higher seismic activity, the country's national regulations are valid and the equipment needs to be adjusted accordingly
- The choice of the external linking cables of the cabins has to suit the country's national technical regulations.
- The cabins have to be secured against thermal overload with a type gL fuse or gG with max. IN = 32A.

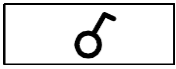
3.2 Labelling of the electric (symbols)

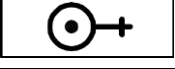
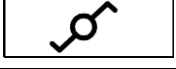
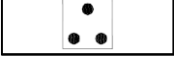
	general light		ventilator
	single socket		spur
	double socket		single light switch
	heater, general		series switch
	boiler, general		dual switch
	mini kitchen		

3.3 Heating and air conditioning

Individual heating through frost heaters, thermostatically controlled electric convectors and/or fan heaters with safety switch for overheating.

Mechanical ventilation options with electrical ventilators or on your request also available with window air conditioning units.

Regular ventilation of the rooms must be provided. A relative humidity of 60 % should not be exceeded in order to avoid condensation!

Description: (amount depends on container type)	ventilator ²	output: 170 m ³ /h
	hygrostatic ventilator	170 m ³ /h
	air conditioning	2,5 kW
	convector heater ¹	2 kW
	convector heater	1 kW
	convector heater	0.5 kW
	fan heater ²	2 kW

All safety distances and instructions issued by the supplier for the equipment must be adhered to!

The appropriate manuals and instructions are sent with the cabins

Safety distance for heaters		
	convector heater	fan heater
top	150 mm	200 mm
below	100 mm	100 mm
right	100 mm	100 mm
left	100 mm	100 mm
in front	500 m	500 mm (to the air grill)
behind	22 mm	26 mm

Further information regarding the instructions are available from the supplier!

4 Water installations

supply supply using ½", ¾" or 1" pipe, sideways through cabin wall

internal: PP-R piping (in accordance with EN ISO 15874)

operating pressure max. permitted operating / connection pressure - 4 bar
warm water preparation: by using electric boilers, depending on the cabin type
(5 15, 80, 150 or 300 liters ²)

ATTENTION:

The boilers with 15/80/150/300 l capacity are suitable for a max. operating pressure of 6 bar. A higher water pressure is reduced with an appropriate pressure reducing valve!

discharge: The waste water is combined via plastic pipes DN 50, DN 100 and DN 125 (external diameter Ø 50, 110 and 125 mm) in the container, and passes laterally through the cabin wall.

The customer must drain any sewage into an approved sewage network in accordance with local regulations for water and faecal drains.

NOTE: Should the cabin not be used at temperatures below +3°C, the entire piping system must be emptied including the boiler (risk of frost!). If residual water is left over (eg. drainage water, etc.) an anti-freeze agent must be used to prevent damage from water freezing. The shut-off valve on the water conduit must always stay open.

5 Design options

General equipment

- external and internal staircase	- telephone duct in the panel
- fascia	- canopy big
- fly screen for office and sanitary windows	- canopy small
- cable bushing in the panel	- hot water radiator upon request
- cable bushing in the roof frame	- motion and presence detector upon request
- cable channel on panel	- Fire rated components 30 / 60 / 90 min according to EN 13501 upon request
- ventilation unit VL-100	

Sanitary fixtures

- plastic sink incl. folding grid	- NIRO wash trough with 2 single basins l=1200 mm
- NIRO sink incl. folding grid	- NIRO wash trough with 3 single basins l=1800 mm
- sanitary fixtures accessible to disabled persons	- NIRO wash trough with 4 single basins l=2400 mm
- floor drain with odour trap	- paper towel dispenser
- boiler: 15 l / 80 l / 150 l / 300 l	- sanitary connection sunk into the panel
- pressure reduction valve	- sanitary connection above floor cut out
- shower cubicle with curtain	- intermediate panel
- GFK hand wash trough with 2 individual basins l = 1,200 mm	- soap dispenser
- GFK hand wash trough with 4 individual basins l = 2,400 mm	- Stop & Go fitting for shower
- wet room electrics	- Stop & Go fitting for wash hand basin
- ceramic hand wash basin	- Undercounter storage 5 litre
- electrical hand dryer	- Urinal
- metal mirror	- Washing machine connection
- mini kitchen	- Water installations (water inlet and outlet)
	- WC cabin

6 Paint

Paint system with high weather and aging durability, suitable for city and industry atmosphere.

wall panels: 25 µm coating thickness

frame: 75-120 µm coating thickness

The painting of above mentioned parts is carried out with different types of production. These achieve shades similar to RAL. We do not accept liability for colour variations in comparison with the RAL tones.

7 Certification

Germanischer Lloyd 'type test'
(except for 24' and 30' container)
Cabins with optional payloads
CE mark, ETA approval *
GostR certification **

* for cont. no. starting with 01, 02, 09, 15

** for cont. no. starting with 21

8 Miscellaneous

8.1 Transport

Containers must be transported on suitable trucks. The local laws for load securing must be adhered to. The containers are not suitable for rail transport. The containers must be transported empty.

The portable cabins can also be delivered flatpacked (Transpack).

Standard package height 648 mm. Four cabins stacked on top of each other have the same external dimensions as a fully assembled cabin.

TP package heights (only for portable cabins and depending on equipment and container size):

- 864 mm - standard with CAH 2,800 mm and 2,960 mm
- 648 mm - standard with CAH 2,591
- 515 mm - depending on layout

8.2 Handling

The following handling instructions for 10', 16', 20', 24' and 30' cabins (assembled or flatpacked) must be observed:

1. The 10', 16' and 20' cabins and/or packets can be lifted with a forklift (length of fork minimum 2,450 mm, width a minimum of 200 mm) or by crane. The ropes/chains need to be fastened to the upper cabin corners. The angle between the rope/chain and the horizontal line must be a minimum of 60° (picture 1). The necessary rope length for a 20' container is at least 6.5 m.
2. The 24' as well as 30' cabins or packages can be loaded with a crane. The ropes/chains must be fastened to the eyebolts/crane eyes screwed on at the top. The angle between the rope/chain and the horizontal line must be a minimum of 60° (picture 3).
3. Due to the construction and design, handling with a spreader is not possible. The cabins may not be handled when loaded.
4. Only single packets of the Transpack cabins are allowed to be lifted.
5. 4 stacking cones (in the cabin corners) each and 2 clamping wedges each for 10', 16' and 20' cabins (1 piece on each side of the longside roof section - fig. 2) or 4 clamping wedges each for 24' and 30' cabins (2 pieces on each side of the longside roof section - fig. 4) must be used between the individual packages.
6. Do not place any extra weight on the top packet!
7. You must only stack max. 5 packets on top of each other. Possible package heights see 8.1.

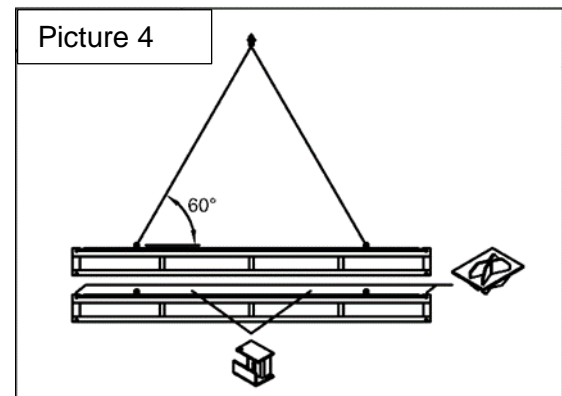
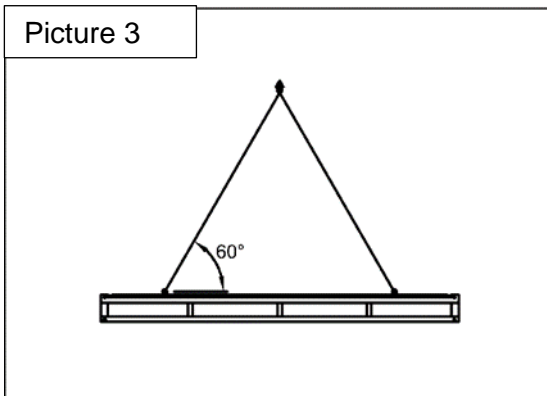
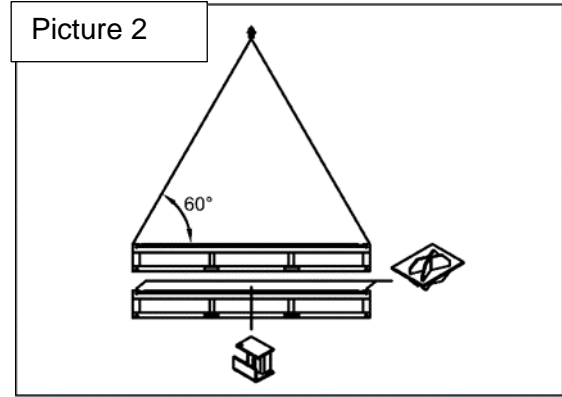
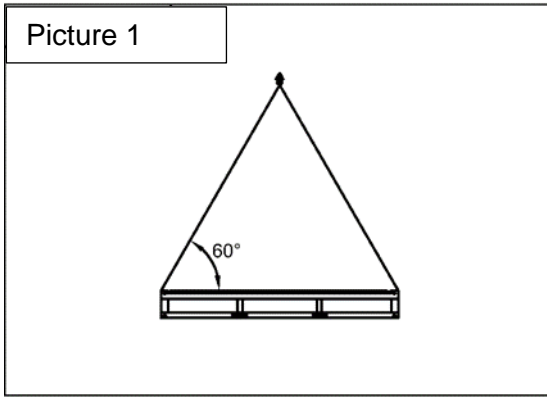

8.3 Installation / Assembly / Statics / Maintenance

In General:

Each individual cabin must be placed on foundations provided on site with at least 4 points of support for 10' cabins, 6 points of support for 16' and 20' cabins (annex 9.3 / 9.4) and at least 8 points of support for 24' and 30' cabins (annex 9.5. 9.6.). The dimensions of the foundation has to be adapted to local circumstances, norms and frost line, under consideration of the local soil condition and the maximum possible loads. The levelness of the foundation is a precondition for a smooth assembly and the failure-free standing of the entire construction. Should the load points not be horizontally aligned, these must be highlighted in the width of the profile.

The design of the foundations must ensure a free flow of rain water. During set up or placement of the cabin (constructions), maximum permitted loads and regional conditions (e.g. snow loads) must be taken into account. After removing the transport covers, the holes in the floor frame must be sealed with silicone. Packaging and transport covers must be disposed of by the customer.

Possible combinations of several cabins:

Individual cabins can be selectively configured next to, behind, or on top of each other, while bearing in mind the structural indications and the max. permitted loads. For one-level (ground level) constructions, the cabins may be placed arbitrarily and without restriction regarding quantity. For two- and three-storey buildings, the combination possibilities presented in appendix 9.1. (10', 16' and 20' cabins) or in appendix 9.2. (30' cabins) must be followed.

In case the cabins are linked in other combinations than presented in appendix 9.1. (10', 16' and 20' cabin) or appendix 9.2. (30' cabin), we can give no statement about the max. permitted wind load. We categorically

recommend keeping a distance from such a practice or to carry out additional anchorings (boltings, supports etc.) with the approval of authorised experts.

The cabins must be stacked exactly on top of each other. The special CTX stacking cones and clamping wedges must be used for this. The container roof is not suitable for storage of goods and materials. The CONTAINEX assembly instructions and the service notes must be adhered to and can be sent upon request.

Handling and installation instructions are enclosed in the cabin and must be observed.

Before starting the work, a risk analysis must be carried out in accordance with the local requirements and the applicable provisions on site. Necessary measures must be implemented by the assembly personnel. Particularly when working on the cabin roof, safeguards must be put in place to stop anyone from falling.

Sanitary fittings:

After connecting to the water supply the entire water circulation should be checked once more for water tightness (possible loosening during transport). Containex denies any warranty for damages, which may result from placement contrary to the principles. Liability for consequential damages is excluded on principle.

Further technical information upon request.

Regulatory and legal requirements regarding storage, installation and use of cabins must be observed by the customer.

The suitability of the cabin (modularsystem) and any supplied accessories (e.g. stairs, air conditioning etc.) for the planned application must be checked by the customer.

Subject to technical alterations!

9 Appendix

9.1 Arrangement options for 10', 16' and 20' containers, max. CAH 2.96m

Number of cabins (SxLxH): Short side (S) x Long side (L) x Height (H)

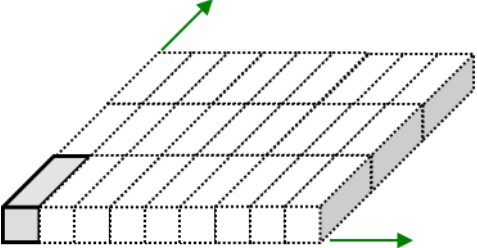
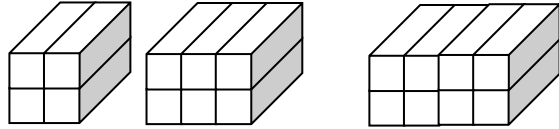
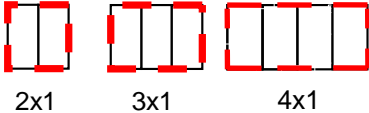
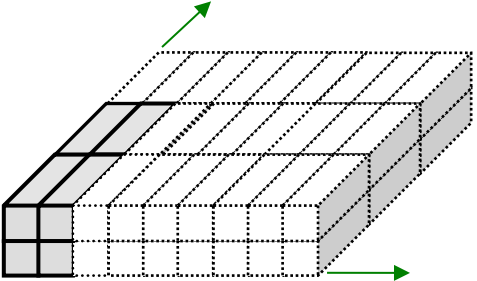
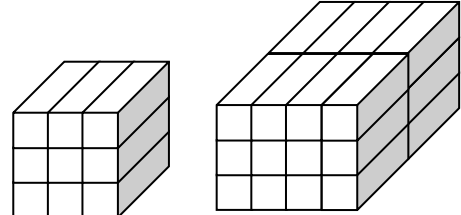
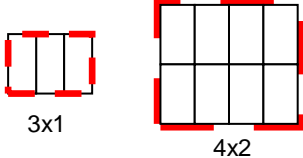
<p>1- storey</p>	 <p>The cabins can be linked at will or positioned individually, without restriction to the size of rooms.</p>	
<p>2- storey</p>	<p>Single line modular buildings (quantity of long sides = 1)</p>  <p>2x1x2 3x1x2 4x1x2</p> <p>The illustrated two-storey modular buildings can be linked at will or positioned individually.. The bracing outer walls must not be removed (maximum room size therefore 4x1 cabins)..</p> <p>Position of the required bracing outer walls (bracing outer walls shown with dashed lines; inside rooms blank)</p>  <p>2x1 3x1 4x1</p>	
	<p>Multiple rows modular buildings (quantity of long sides ≥ 2)</p>  <p>From a minimum size of 2x2x2 cabins an extension of the building in all directions is possible, without restriction to the size of rooms..</p>	
<p>3- storey</p>	 <p>3x1x3 4x2x3</p> <p>The illustrated three-storey modular buildings can be linked at will or positioned individually. The bracing outer walls must not be removed (maximum room size therefore 4x2 cabins).</p> <p>Position of the required bracing outer walls Bracing outer walls shown with dashed lines. The panel wall in the upper floors must be placed over a panel wall in the floor below.</p>  <p>3x1 4x2</p>	<p>Load capacities in accordance with 1.5.</p>

9.2 Arrangement options for 24' and 30'¹ containers, max. external height 2.96 m

Number of cabins (SxLxH): Short side (S) x Long side (L) x Height (H)

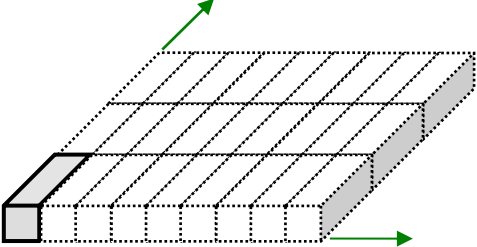
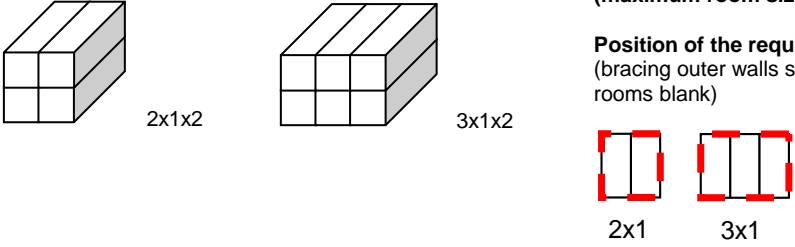
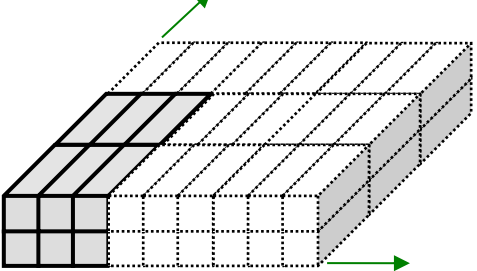
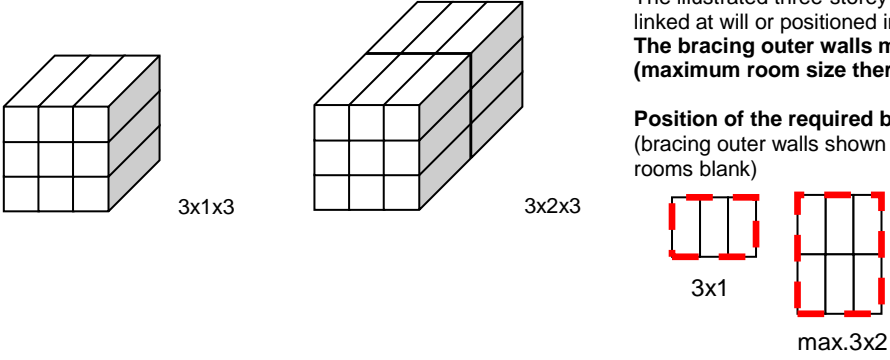
<p>1- storey</p>		<p>The cabins can be linked at will or positioned individually, without restriction to the size of rooms.</p>	<p>Load capacities in accordance with 1.5.</p>
<p>Single line modular buildings (quantity of long sides = 1)</p>		<p>The illustrated two-storey modular buildings can be linked at will or positioned individually. The bracing outer walls must not be removed (maximum room size therefore 3x1 cabins).</p> <p>Position of the required bracing outer walls (bracing outer walls shown with dashed lines; inside rooms blank)</p> 	
<p>Multiple rows modular buildings (quantity of long sides ≥ 2)</p>		<p>From a minimum size of 2x2x2 cabins an extension of the building in all directions is possible, without restriction to the size of rooms.</p>	
		<p>From a minimum size of 3x3x2 cabins an extension of the building in all directions is possible, without restriction to the size of rooms.</p>	
<p>3- storey</p> 		<p>The illustrated three-storey modular buildings can be linked at will or positioned individually. The bracing outer walls must not be removed (maximum room size therefore 3x2 cabins).</p> <p>Position of the required bracing outer walls (bracing outer walls shown with dashed lines; inside rooms blank)</p>	

¹ except 30' cabins with optional payloads

9.3 Standard foundation plan for 10', 16' und 20' cabin (load capacities in accordance with 1.5.1.)

Each individual cabin must be placed on foundations provided on site with at least 4 points of support for 10' cabins, 6 points of support for 16' or 20' cabins. The smallest foundation size is 20 x 20 cm, but dimensions of the foundation have to be adapted to local circumstances, norms and frost line, under consideration of the local soil condition and the maximum possible loads. These measures have to be undertaken by the buyer/hirer.

Cabin length (l); Cabin width (b)

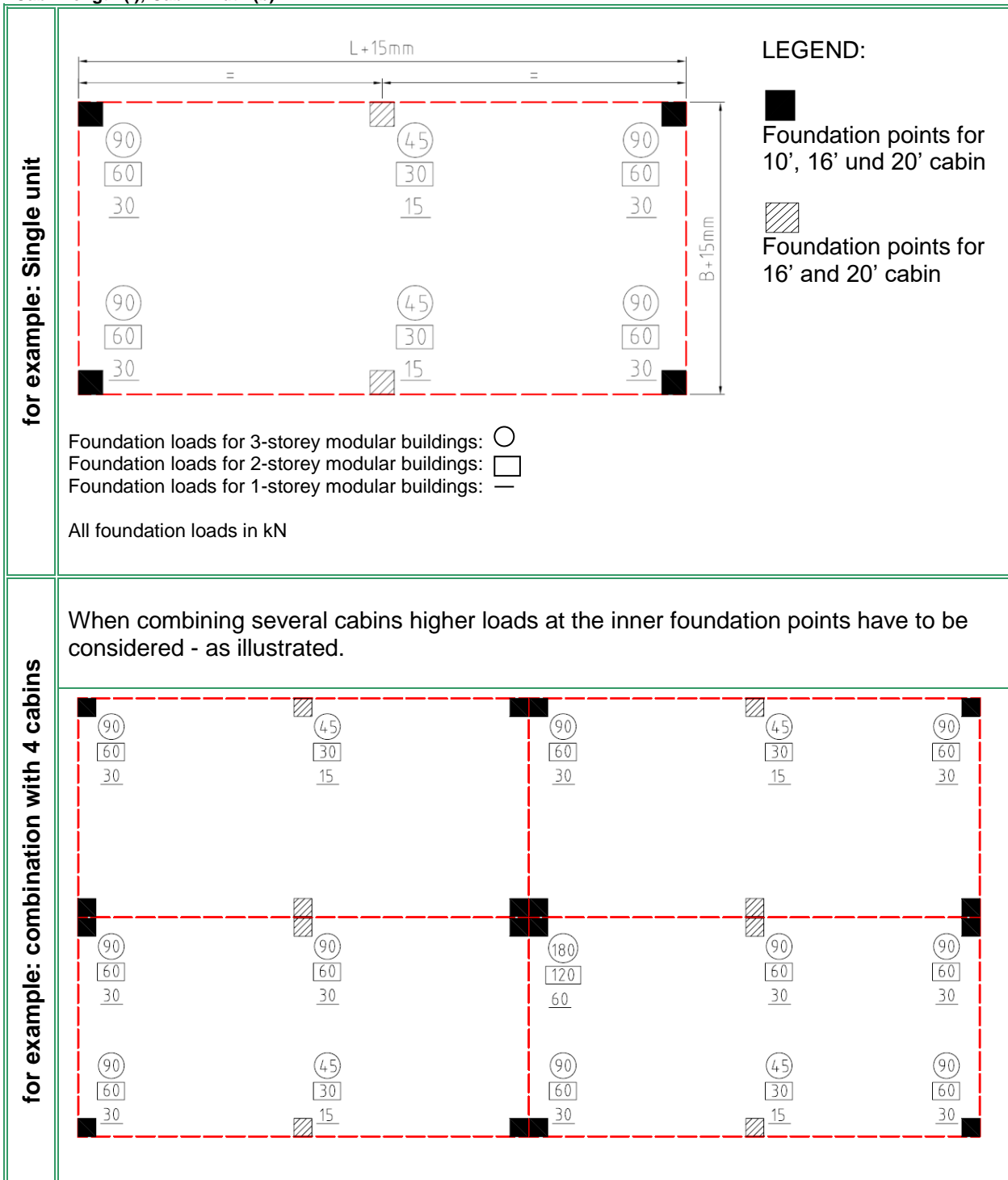

9.4 General foundation plan for 10', 16' and 20' containers with optional load capacities (in accordance with 1.5.2.)

Each individual cabin must be placed on foundations provided on site with at least 4 points of support for 10' cabins, 6 points of support for 16' or 20' cabins. The smallest foundation size is 20 x 20 cm, but dimensions of the foundation have to be adapted to local circumstances, norms and frost line, under consideration of the local soil condition and the maximum possible loads. These measures have to be undertaken by the buyer/hirer.

Cabin length (l); Cabin width (b)

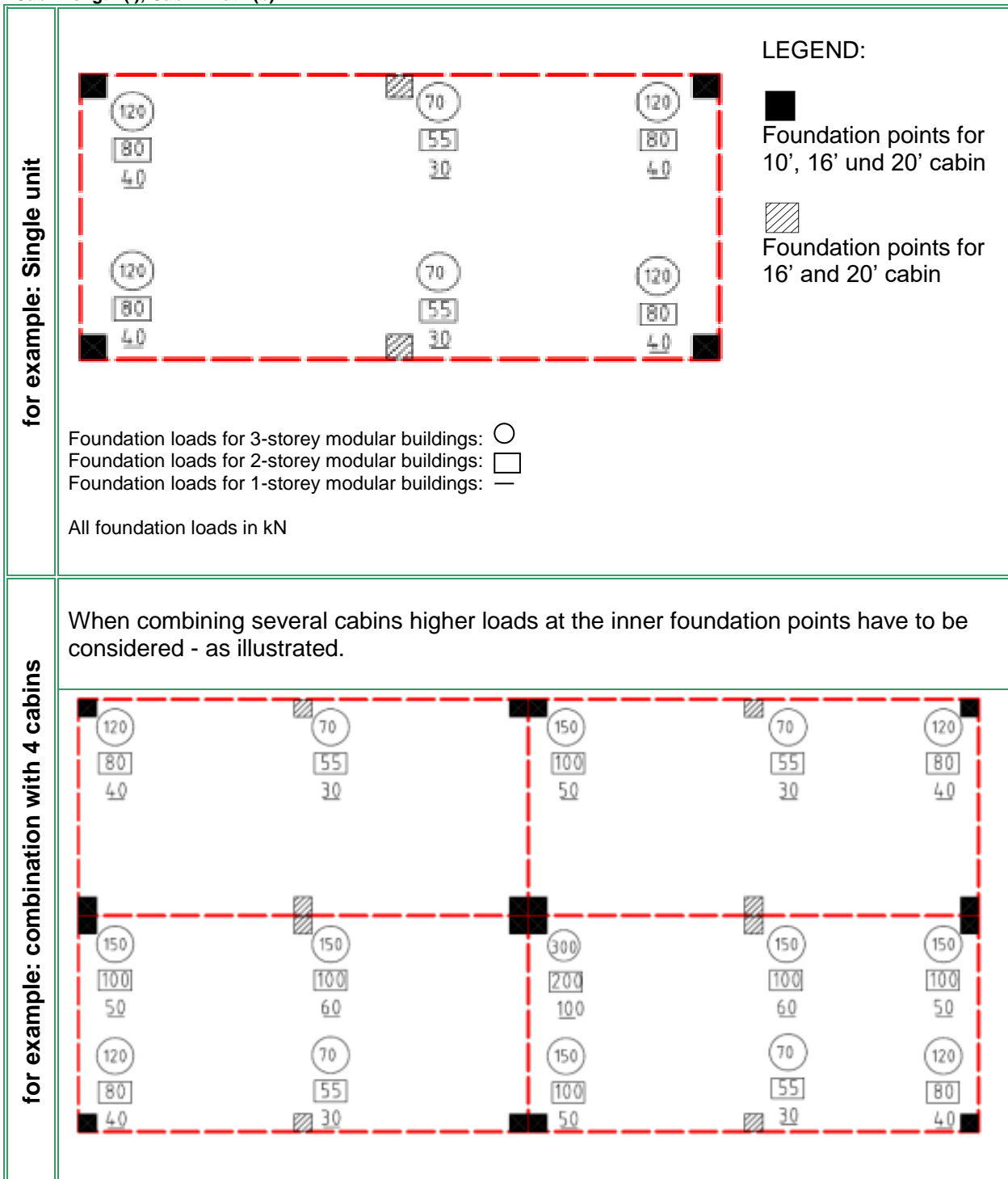

9.5 General foundation plan for 24' and 30' containers (in accordance with 1.5.1.)

Each individual cabin must be placed on foundations provided on site with at least 8 points of support. The smallest foundation size is 20 x 20 cm, but dimensions of the foundation have to be adapted to local circumstances, norms and frost line, under consideration of the local soil condition and the maximum possible loads. These measures have to be undertaken by the buyer/hirer.

Cabin length (l); Cabin width (b)

