

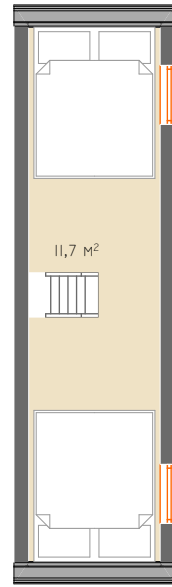

lfloor

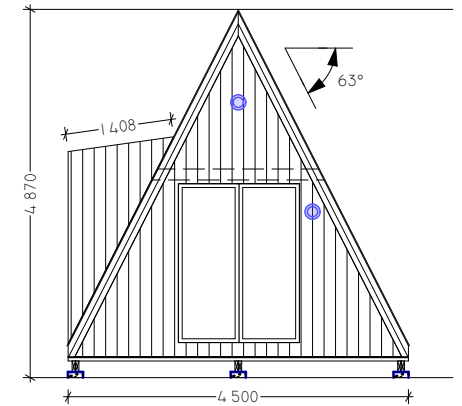
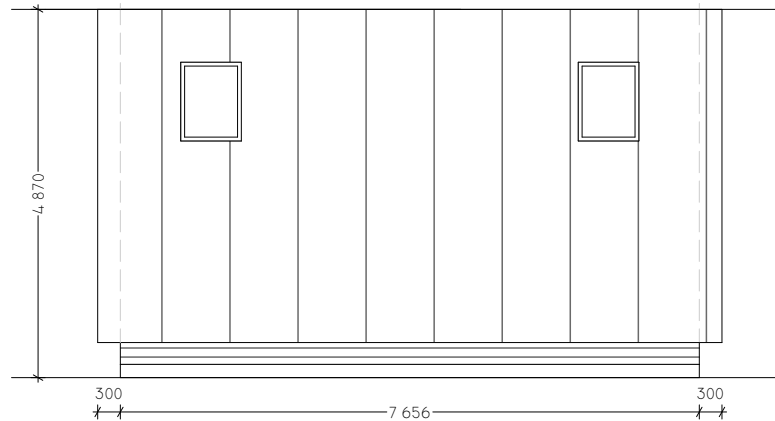
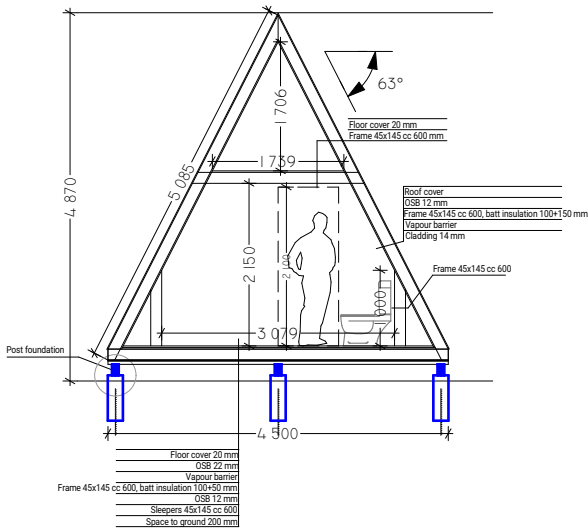
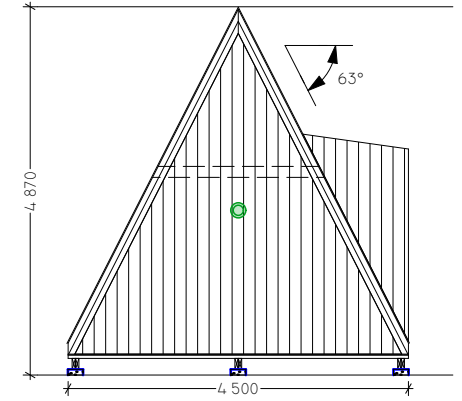
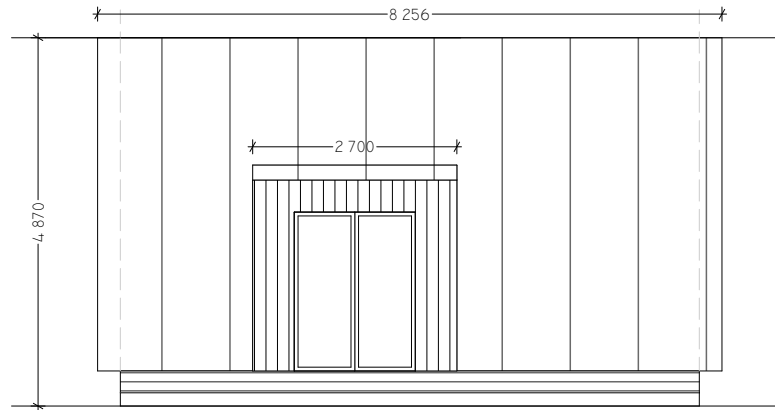

loft

Floor area 33,9 m²
 Building area 34,2 m²
 Heating volume 65 m³
 Heating (Fireplace) 4kW



Date	Sheet	Drawing	Project ID	
14.01.2022	1:100 A4	Plans	SOLO+75	