

FLOOR AREA 413 FT²
 BUILDING AREA 491 FT²
 HEATING VOLUME 3000 FT³
 HEATING (FIREPLACE) 5KW

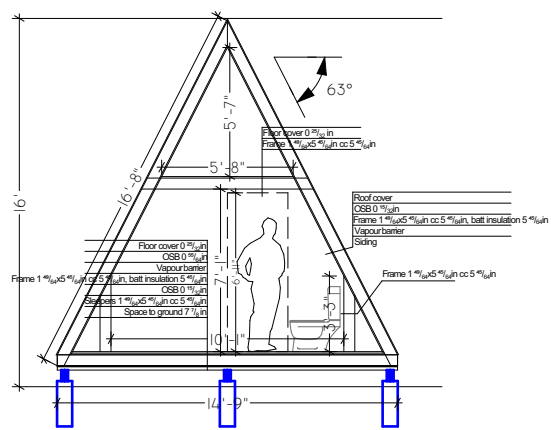

Date	Sheet	Drawing	Project ID
21.01.2022	1:100 A4	Plans	SOLO+100

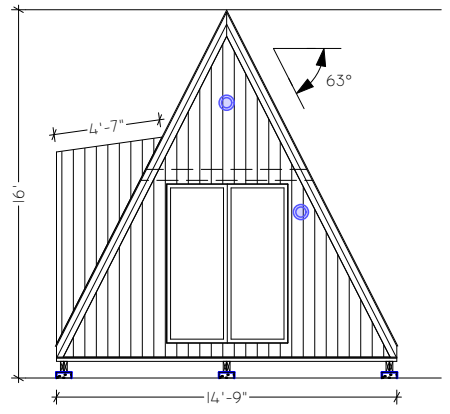
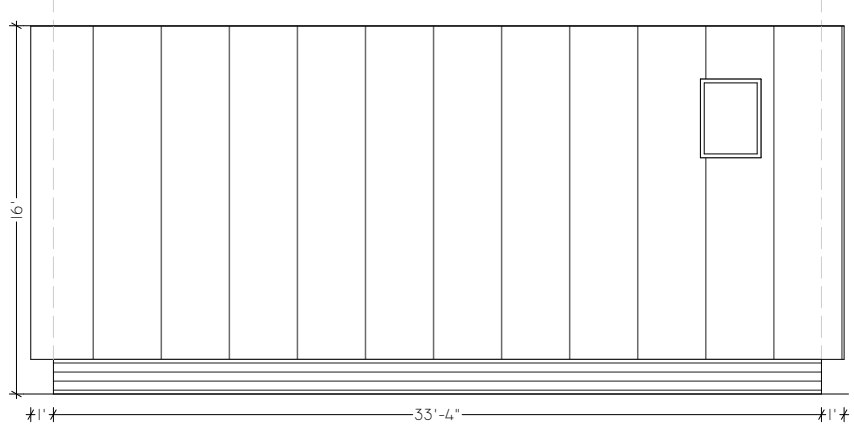
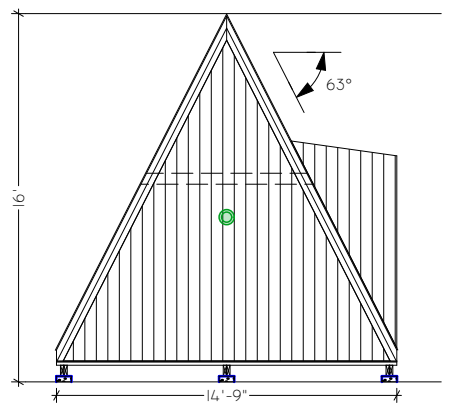
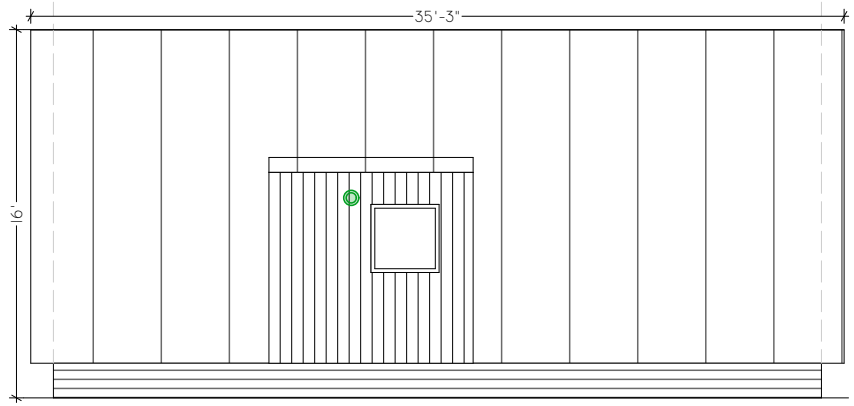