

BCBAL2(NF)

V.7

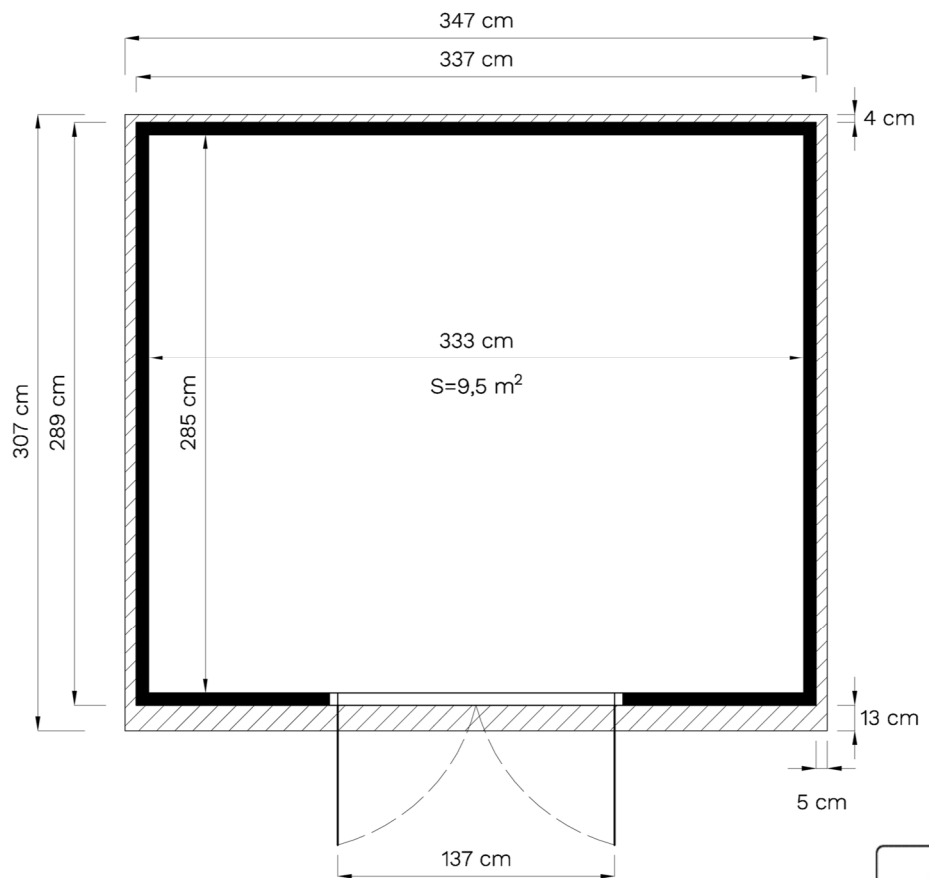

DE - Technische Änderungen vorbehalten.
Alle Maße sind ca. Maße.
EN - Technical modifications reserved.
All dimensions are approximate dimensions.

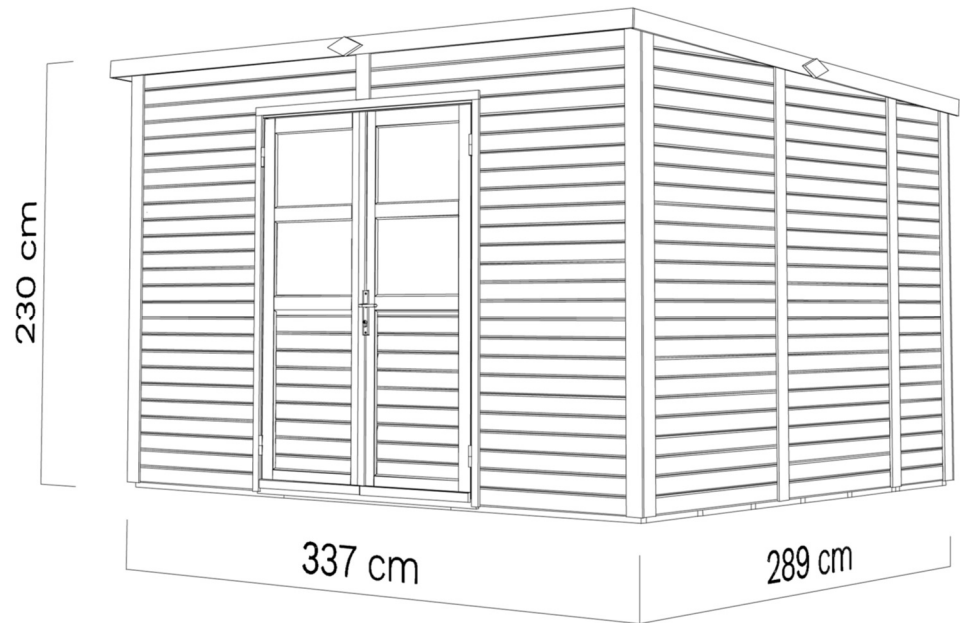

BCBAL2(NF)

DE **Bevor Sie beginnen**

• Es ist empfehlenswert sich etwas Zeit zu nehmen, um die Aufbauanleitung anzusehen, bevor mit dem Aufbau begonnen wird. • Alle Schritte für den Aufbau werden – auch in Detailbildern – dargestellt. • Die vorgegebene Reihenfolge ist zu beachten. • Bitte prüfen Sie vor dem Aufbau anhand der Teileliste die Vollständigkeit und den Zustand der Lieferung. • Besonders wichtig ist der Holzschutz! Die Boden-elemente sind vor dem Aufbau von unten mit einem geeigneten Holzschutz zu behandeln! • Das für die meisten Produkte online verfügbare Datenblatt bietet weitere wichtige Hinweise für den Aufbau. • Beigefügt sind auch die Garantiebedingungen.

FR **Avant de commencer**

• il est recommandé de prendre le temps de lire les instructions de montage avant de commencer. • Toutes les étapes du montage sont présentées, y compris sur des illustrations détaillées. • L'ordre prescrit doit être respecté. • Avant le montage, vérifier l'exhaustivité et l'état de la livraison à l'aide de la liste des pièces. • La protection du bois est particulièrement importante! Avant le montage, les éléments de plancher doivent être traités par le bas avec un produit de protection du bois approprié! • La fiche technique disponible en ligne pour la plupart des produits fournit d'autres informations importantes pour le montage. • Les conditions de garantie y sont également jointes.

CZ **Než začnete**

• Doporúčujeme, abyste si vzali trochu času k prohlédnutí montážního návodu, než s montáží začnete. • Všechny montážní kroky jsou zobrazeny - také na podrobných obrázcích. • Je nutné dodržovat uvedený postup. • Před montáží zkontrolujte podle seznamu dílů, zda jste obdrželi všechny díly a zda je dodávka v dobrém stavu. • Obzvláště důležitá je dřevěná botka! Podlahové prvky musí být před montáží zespoda ošetřeny vhodným ochranným přípravkem na dřevo! • Datový list, který je k dispozici online pro většinu produktů, poskytuje další důležité pokyny k montáži. • V příloze naleznete také záruční podmínky.

DK **Før du starter**

• Det kan anbefales at tage sig tid til at kigge på samlevejledningen, før du starter samlingen. • Alle trin i samlingen bliver vist – også i detaljerede billeder. • Overhold den angivne rækkefølge. • Kontrollér, at leveringen er fuldstændig og i den rette tilstand ved hjælp af delelisten, før du starter samlingen. • Særligt vigtig er træbeskyttelsen! Gulvelementerne skal behandles med egnet træbeskyttelse nedefra, før du starter samlingen! • Til de fleste produkter kan du finde datablade online, der indeholder yderligere vigtige informationer til samlingen. • Garantibetingelserne er også vedlagt.

NL **Voordat u begint**

• Het is aan te bevelen om de tijd te nemen om de opbouwhandleiding door te nemen voordat er met het opbouwen wordt begonnen. • Alle stappen voor het opbouwen worden - ook met gedetailleerde afbeeldingen - weergegeven. • Neem de aangegeven volgorde in acht. • Controleer voor het opbouwen aan de hand van de onderdelenlijst de volledigheid en de hoedanigheid van de levering. • Bijzonder belangrijk is de bescherming van het hout! De vloerelementen moeten voor het opbouwen van anderen met een geschikt houtbeschermingsmiddel worden behandeld! • Het voor de meeste producten online beschikbare gegevensblad bevat verdere belangrijke aanwijzingen voor de opbouw. • Bijgevoegd zijn ook de garantiebepalingen.

PL **Przed rozpoczęciem**

• Wskazane jest, aby przed przystąpieniem do montażu zapoznać się z instrukcją montażu. • Pokazane są wszystkie etapy montażu – również na szczegółowych zdjęciach. • Należy przestrzegać podanej kolejności. • Przed montażem należy skorzystać z listy części, aby sprawdzić, czy dostawa jest kompletna i w dobrym stanie. • Ochrona drewna jest szczególnie ważna! Przed montażem elementy podłogowe należy zabezpieczyć od dołu odpowiednim środkiem do konserwacji drewna! • Arkusz danych, który jest dostępny online dla większości produktów, zawiera dalsze ważne informacje dotyczące montażu. • Załączone są również warunki gwarancji.

SV **Innan du börjar**

• Vi rekommenderar att du åsidosätter lite tid för att titta igenom monteringsanvisningen innan du påbörjar monteringen. • Alla monteringsstegen visas – även med detaljerade bilder. • Den angivna ordningen måste följas. • Kontrollera att leveransen är komplett och i gott skick innan monteringen påbörjas med hjälp av listan över delar. • Träskyddet är av yttersta vikt! Golvelementen ska behandlas underifrån med lämpligt träskyddsmedel före monteringen! • Annan viktig information före montering finns i databladet (tillgängligt online för de flesta produkter). • Garantivillkoren bifogas också.

RO **Înainte să începeți**

• Vă recomandăm să dedicați puțin timp pentru a consulta Instrucțiunile de asamblare înainte de a începe asamblarea. • Toate etapele de asamblare sunt prezentate amănunțit - și în forma unor figuri detaliate. • Respectați ordinea specificată. • Înainte de asamblare, vă rugăm să verificați lista de componente pentru a vă asigura că furnitura este completă și în stare bună. • Acordați o deosebită atenție protecției lemnului! Elementele de podea trebuie tratate de dedesubt cu o substanță conservantă adecvată pentru protecția lemnului înainte de asamblare! • Fișa de date, care este disponibilă și online pentru majoritatea produselor, oferă informații suplimentare importante cu privire la asamblare. • Atașat veți găsi și condițiile de garanție.













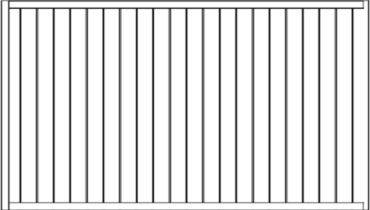
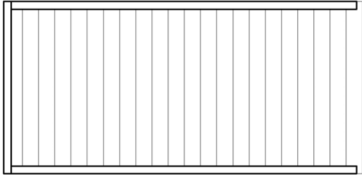
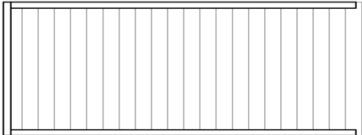

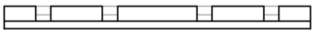

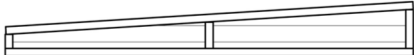



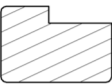

EE **Soovitused enne paigalduse alustamist**

• Soovitame enne paigalduse alustamist võtta aega ja tutvuda paigaldusjuhendiga. • Kõik kokkupaneku etapid on näidatud ka üksikasjalikel piltidel. • Paigaldustööd tuleks teha etteantud järjekorras. • Enne paigalduse alustamist kontrollige detailide nimekirja alusel, kas kõik elemendid on olemas ja ega need pole kahjustada saanud. • Puidukaitse on eriti oluline! Põrandaelemente tuleb enne kokkupanekut töödelda altpoolt sobiva puidukaitsevahendiga! • Andmeleht, mis on enamiku toodete kohta internetis saadaval, pakub kokkupanekuks täiendavat olulist teavet. • Lisatud on ka garantiitingimused.

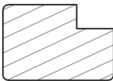
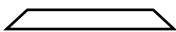











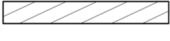

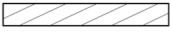

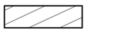
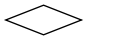



EN **Before assembly**

• We recommend that time is taken to read the assembly instructions prior to assembly. • All assembly steps are shown – also in detailed images. • The step-by-step instructions must be followed. • Before assembly, please use the parts list to check that all components are accounted for and in good condition. • Wood protection is particularly important! The floor elements must be treated from below with a suitable wood preservative before assembly! • The data sheet, which is available online for most products, offers further important information for assembly. • The guarantee conditions are also attached.

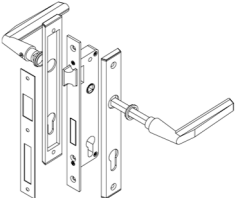
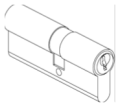
BCBAL2(NF)

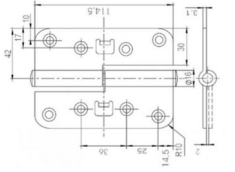
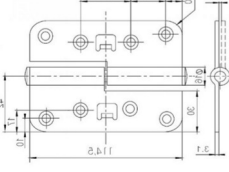
ID	Details in mm (Tolerance/Toleranz ...+ 2mm)	Pcs.	ID	Details in mm (Tolerance/Toleranz ...+ 2mm)	Pcs.
1112	16 x 1109 x 2300 	x 3	1254	16 x 554 x 1109 	x 3
148	60 x 1109 x 1953 	x 7	330	60 x 938 x 1953 	x 2
149	60 x 554 x 1953 	x 2	331	60 x 305 x 1663 	x 2
332	60 x 134 x 1663 	x 2	333	60 x 305 x 2218 	x 1
334	60 x 305 x 2218 	x 1	335	60 x 169 x 554 	x 1
336	60 x 169 x 554 	x 1	40	32 x 690 x 1868 	x 1
39	32 x 690 x 1868 	x 1	556	3 x 395 x 550 	x 4
967	40 x 80 x 2000 	x 16	968	40 x 80 x 850 	x 16
867	40 x 60 x 1878  	x 2	957	40 x 60 x 1451 	x 1
857	40 (41*) x 60(41*) x 500  	x 8	958	28 x 28 x 1725 	x 4
959	28 x 28 x 1502 	x 4	1017	15 x 15 x 1371 	x 1
			1114	41 x 41 x 1663 	x 18
			1116	41 x 41 x 400 	x 9

BCBAL2(NF)

ID	Details in mm (Tolerance/Toleranz ...+ 2mm)	Pcs.	ID	Details in mm (Tolerance/Toleranz ...+ 2mm)	Pcs.
756	19 x 45 x 2245 	x 4	961	19 x 45 x 1451 	x 1
670	12 x 90 x 2245 	x 14	962	12 x 90 x 1740 	x 2
963	12 x 90 x 1535 	x 4	969	12 x 90 x 280 	x 1
595	12 x 42 x 1926 	x 3	964	12 x 42 x 1495 	x 2
			628	12 x 90 x 201 	x 3
982	15 x 15 x 552 	x 8	983	15 x 15 x 368 	x 8
1502	Ø4,5 x 70 	x360	1503	Ø4,5 x 50 	x 130
1506	Ø3,5 x 35 	x312	1508	Ø4 x 25 	x 8
1512	Ø1,5 x 25 	x 56			
1510	Ø1,5 x 19 	x 8			
1531		x 1	VR1515		
1531-1		x 1	1557		x 2
1527		x 2	1555		x 2
1517		x 2	966		
516	12 x 830 x 1150 	x 9	965	12 x 570 x 1150 	x 3

BCBAL2(NF)

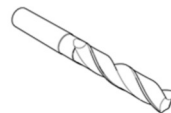
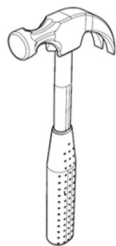
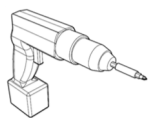

Ø 4 mm

Ø 8 mm

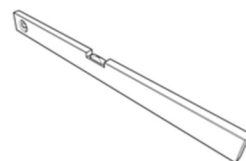
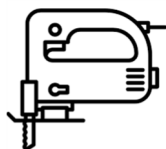

1.

1112

4 mm

50 mm x 81 St



1254

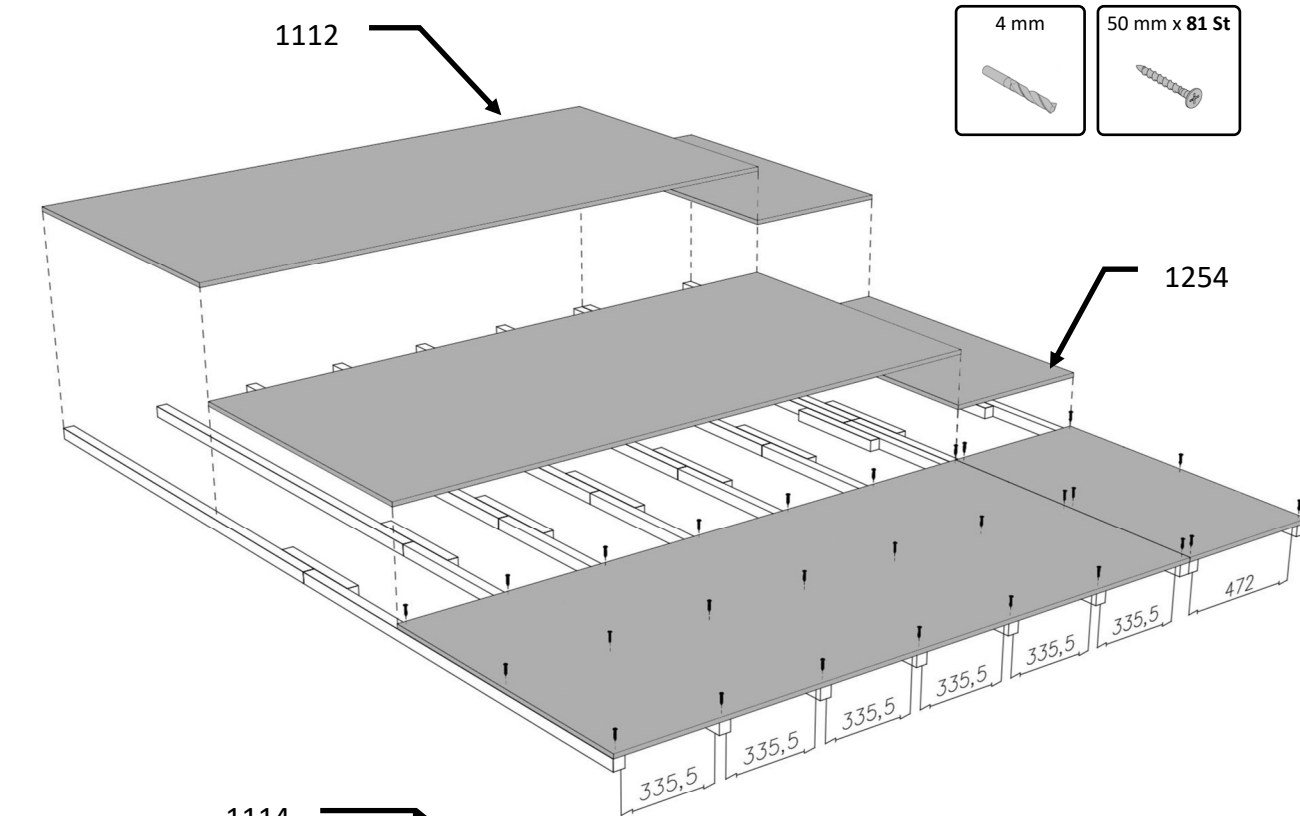

X 9

1114

1116

4 mm

70 mm x 4 St



BCBAL2(NF)

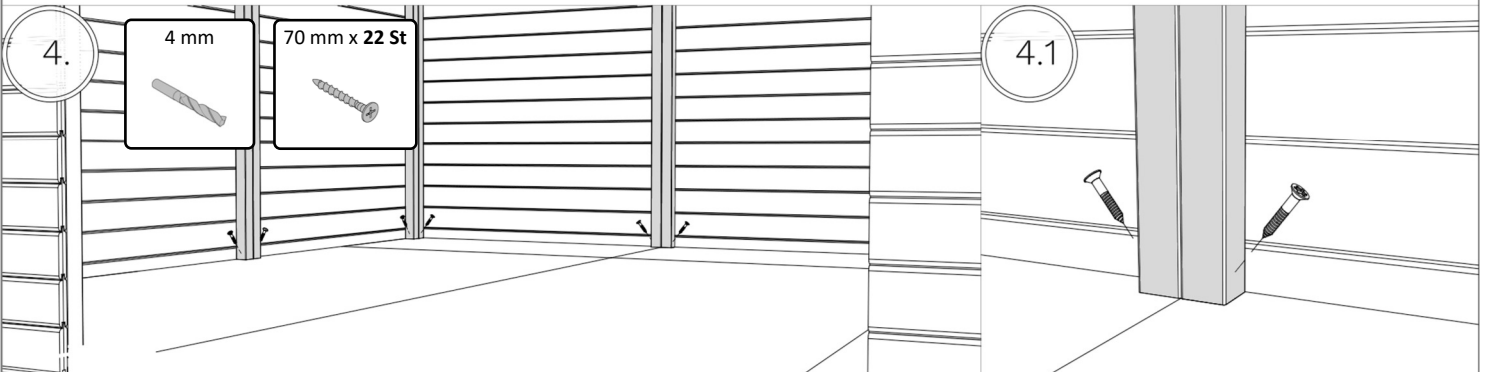
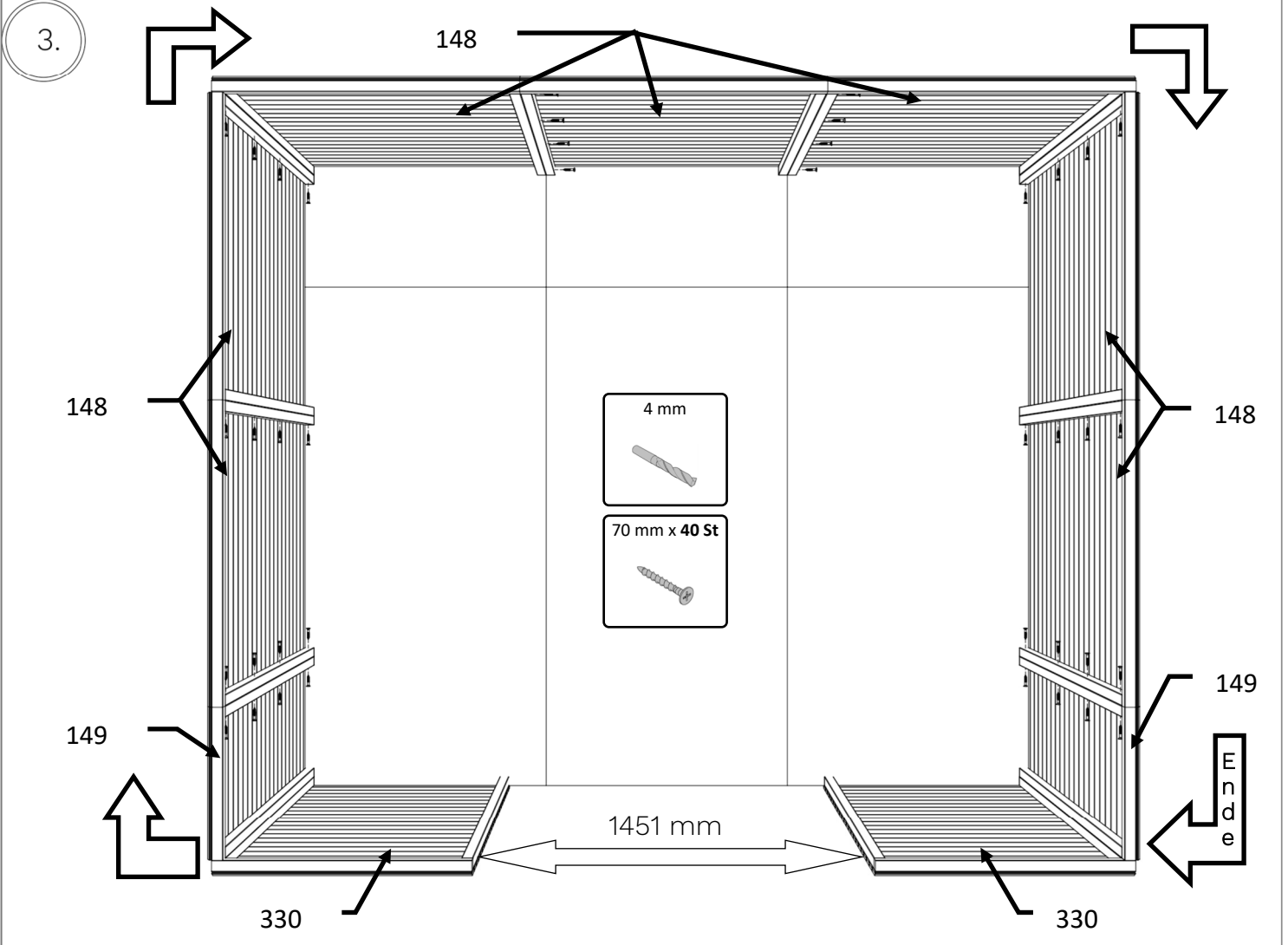
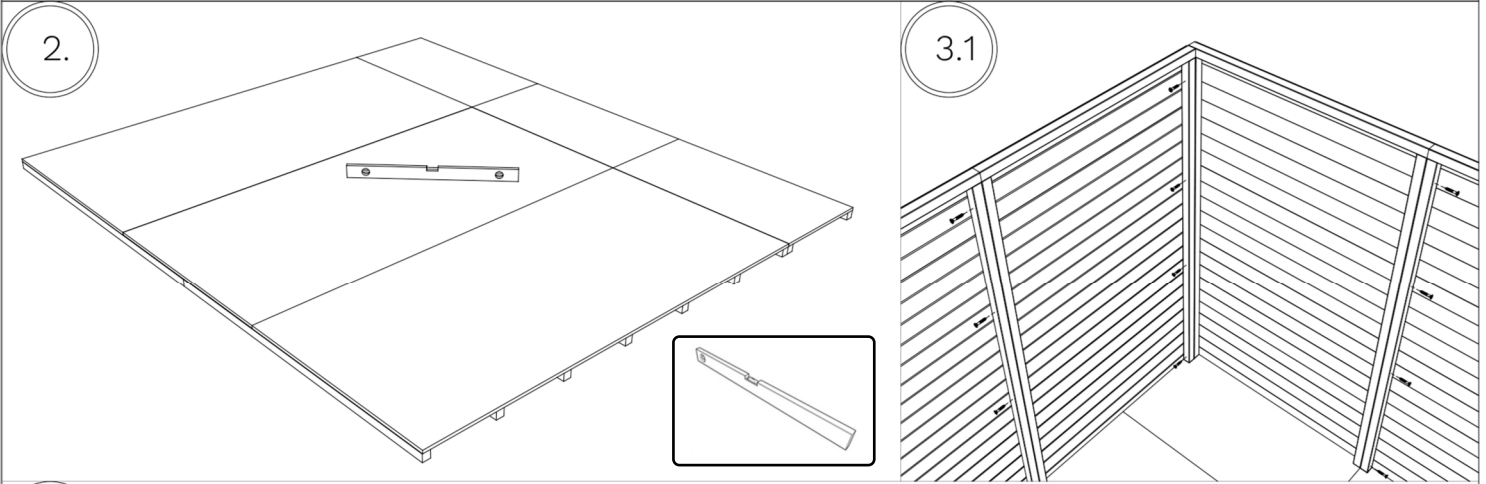

BCBAL2(NF)

5.

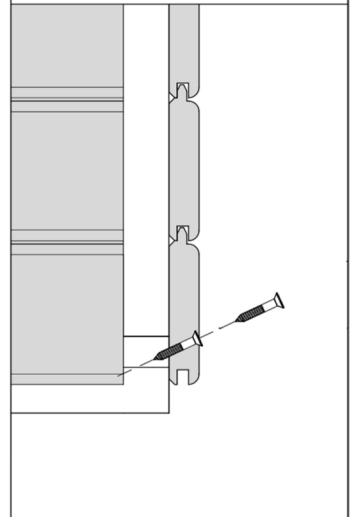
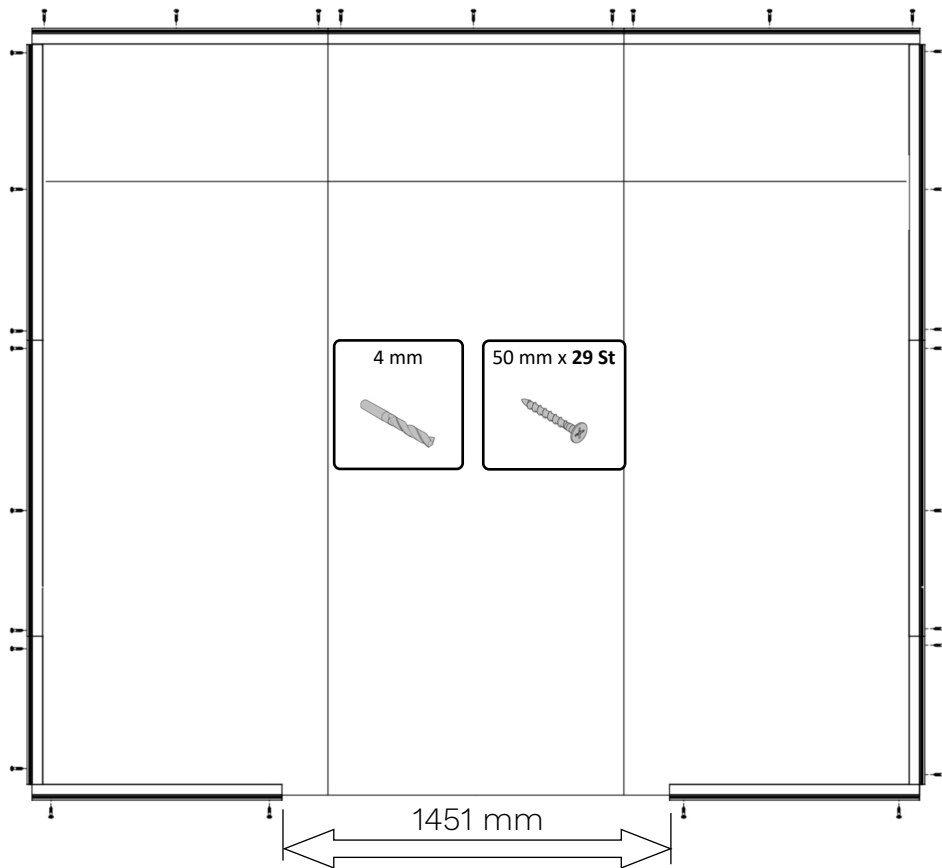

6.

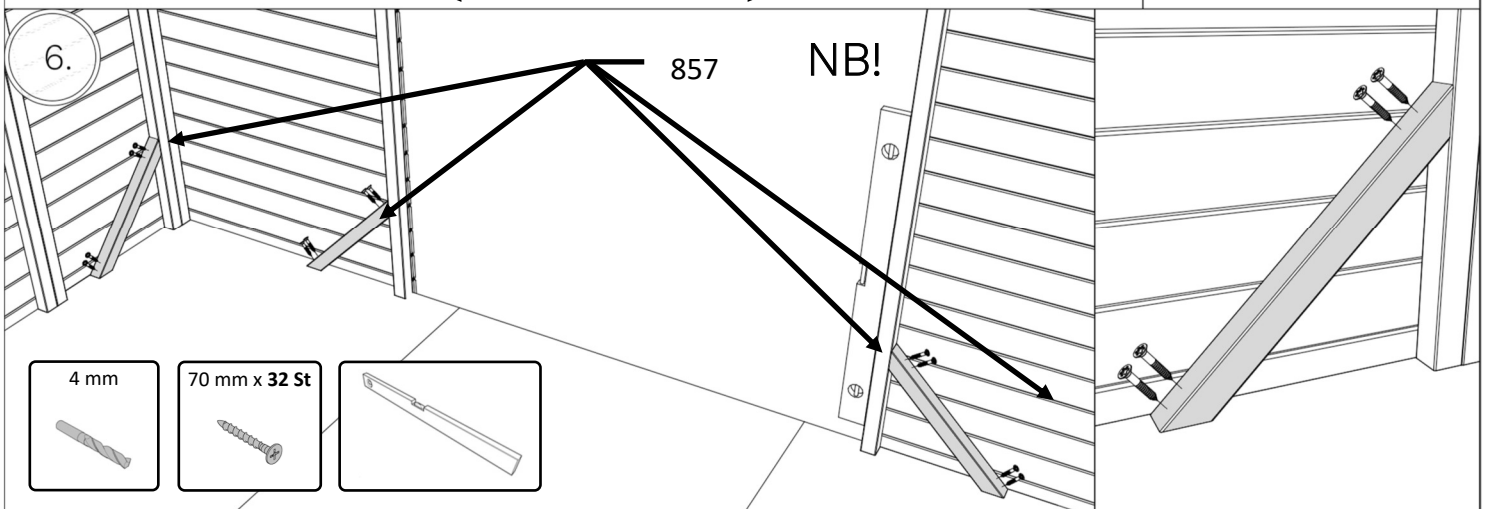

6.1

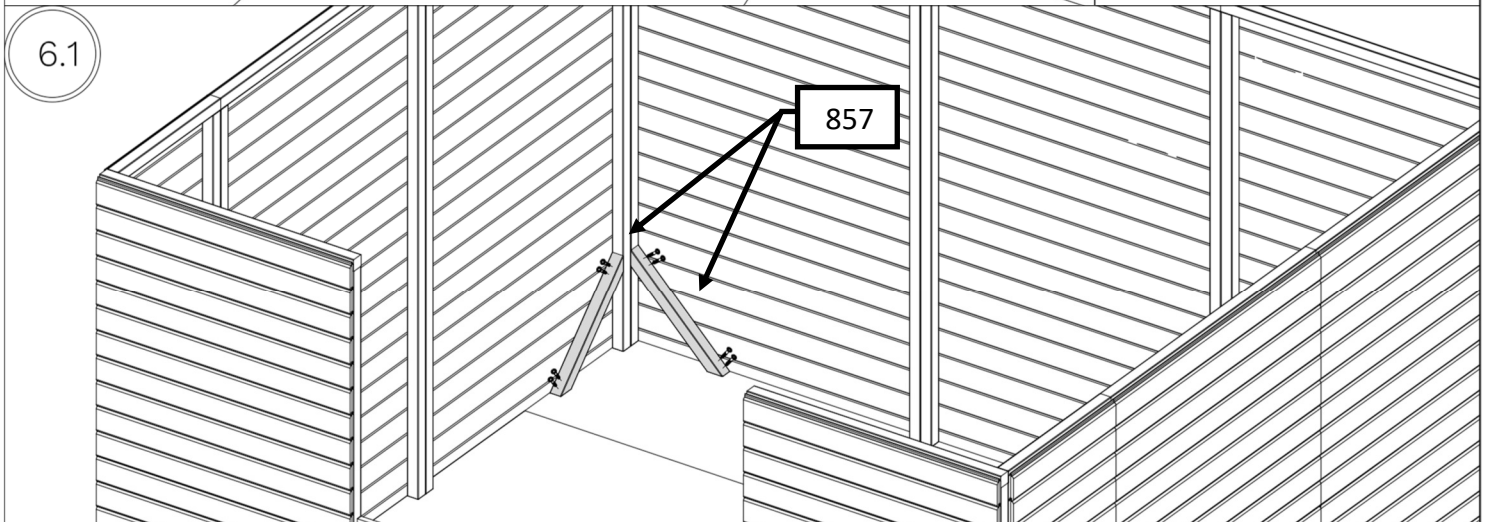

BCBAL2(NF)

8.

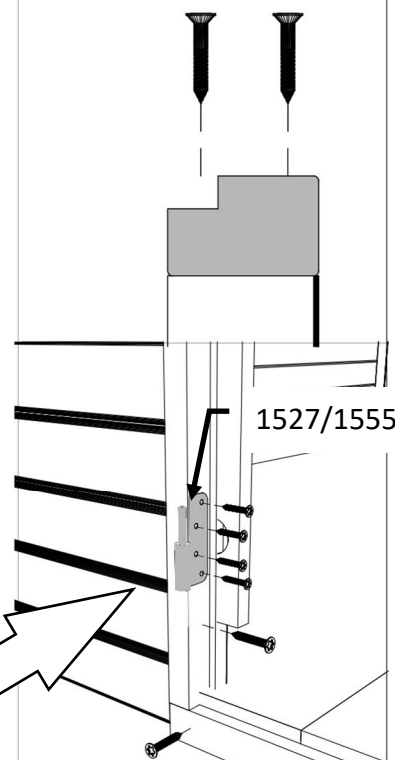
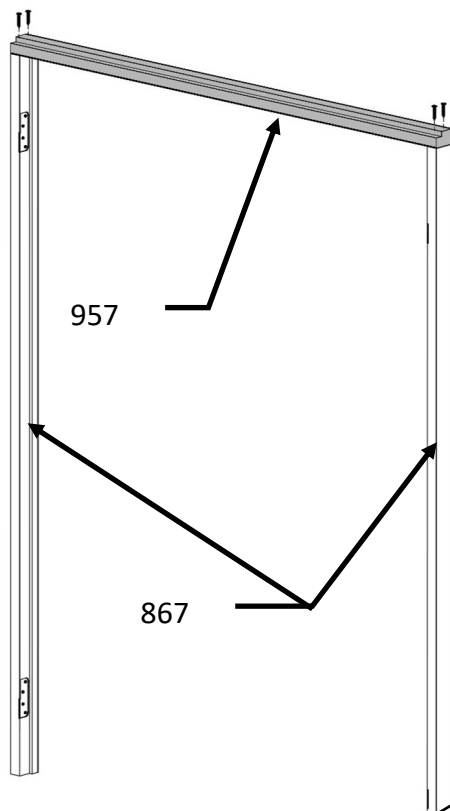
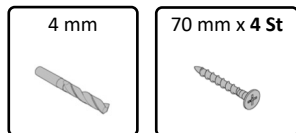

9.

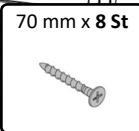
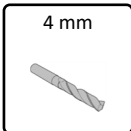

1371 mm

1555

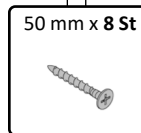

1527

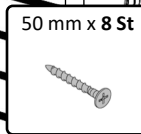

35 mm x 4 St

961

BCBAL2(NF)

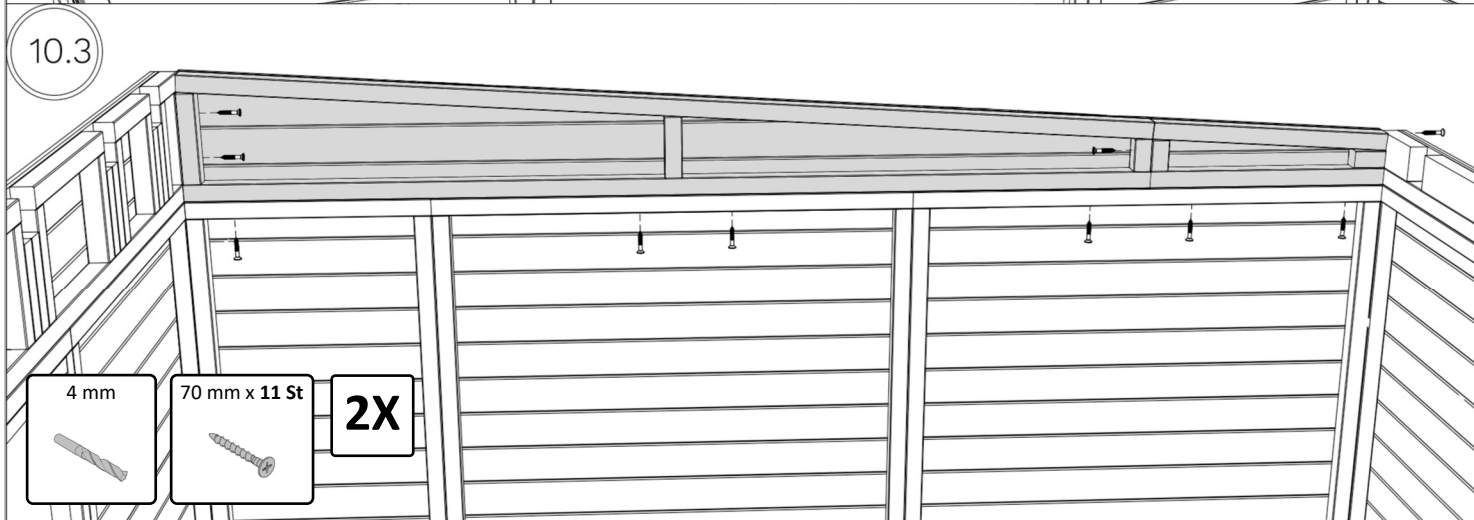
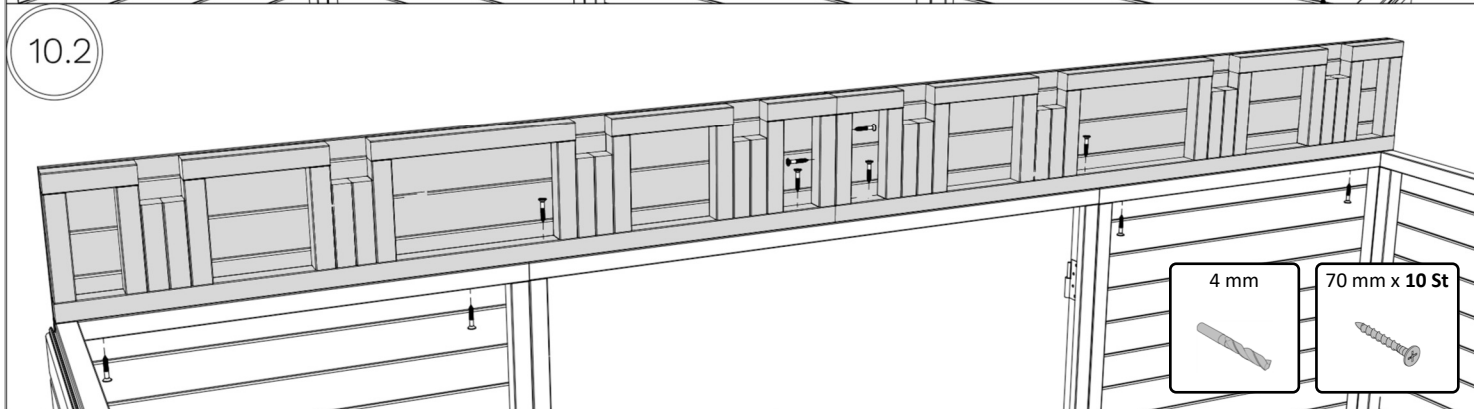
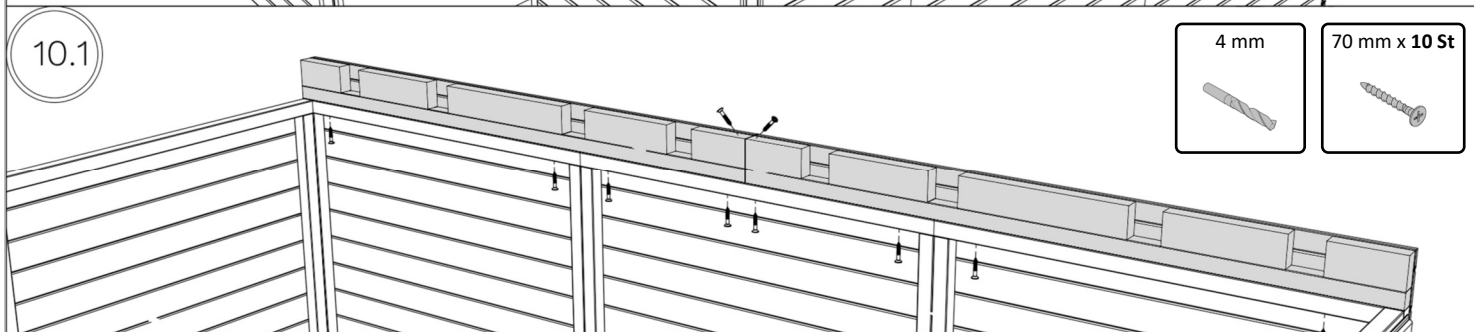
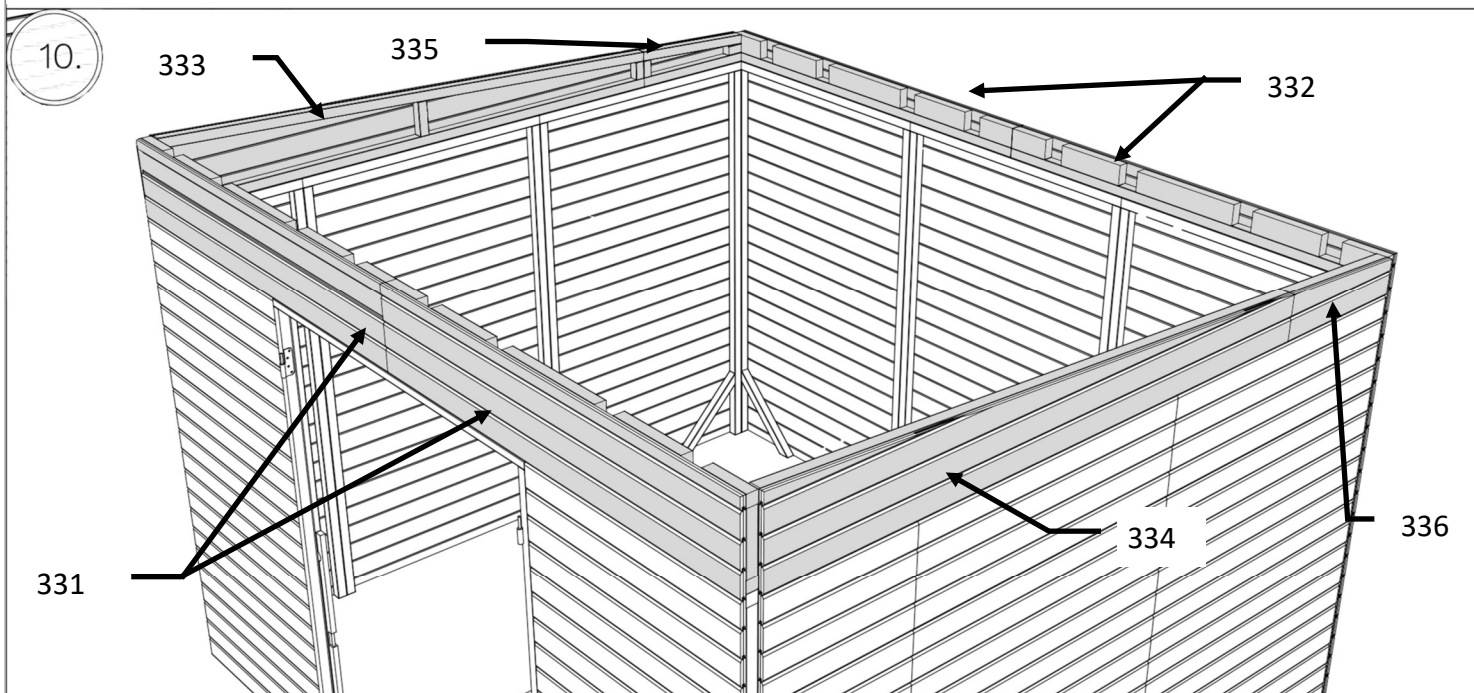

BCBAL2(NF)

12.

8X

4 mm

70 mm x 18 St



968

967

968

13.

4 mm

70 mm x 16 St



14.

4 mm

70 mm x 16 St



BCBAL2(NF)

15.

35 mm x 12 St

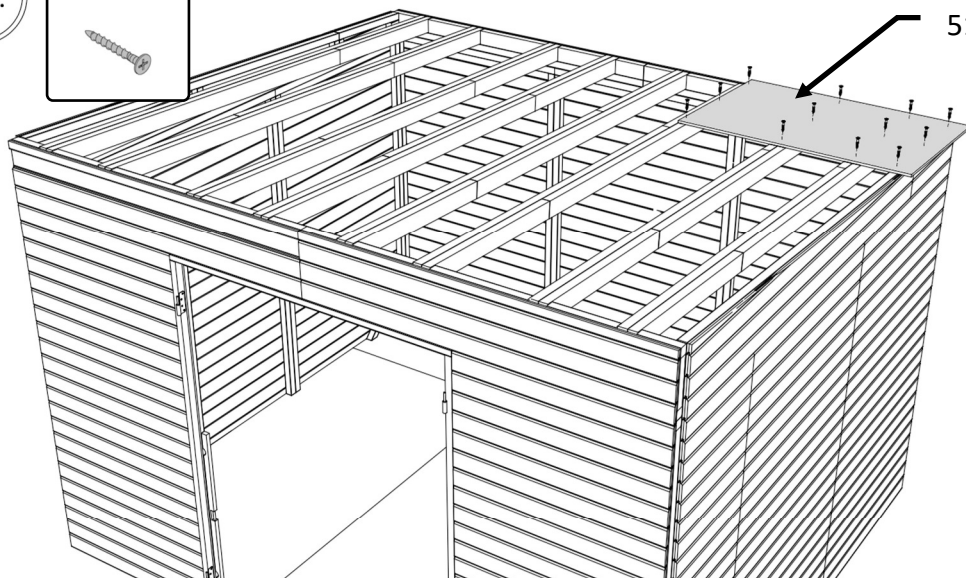

516

42 mm

15.1

117 mm

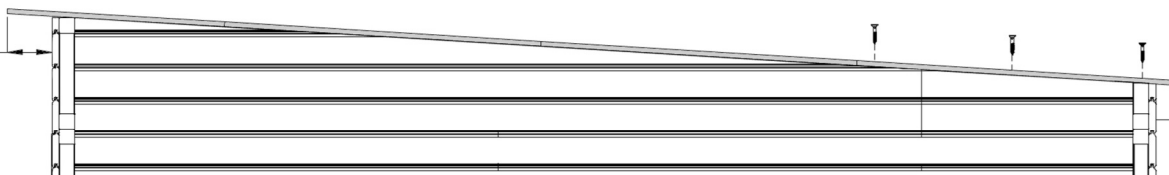

45 mm

16.

516

35 mm x 96 St

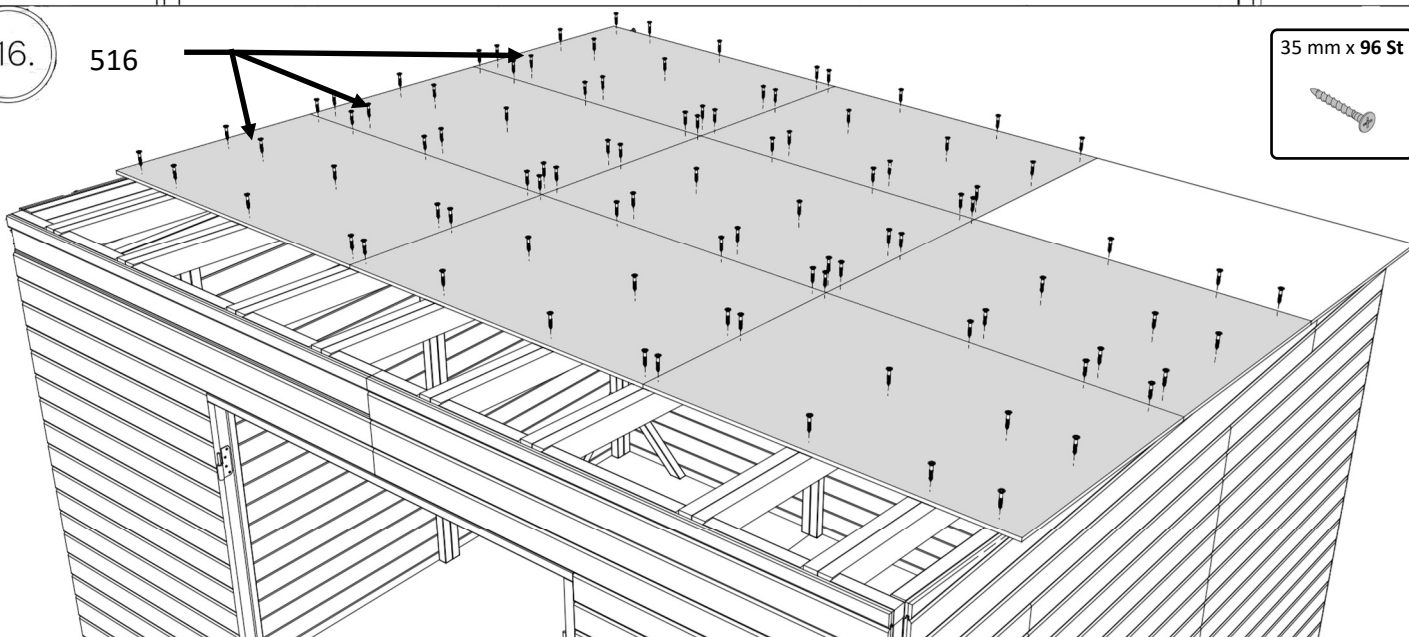

17.

35 mm x 24 St



965

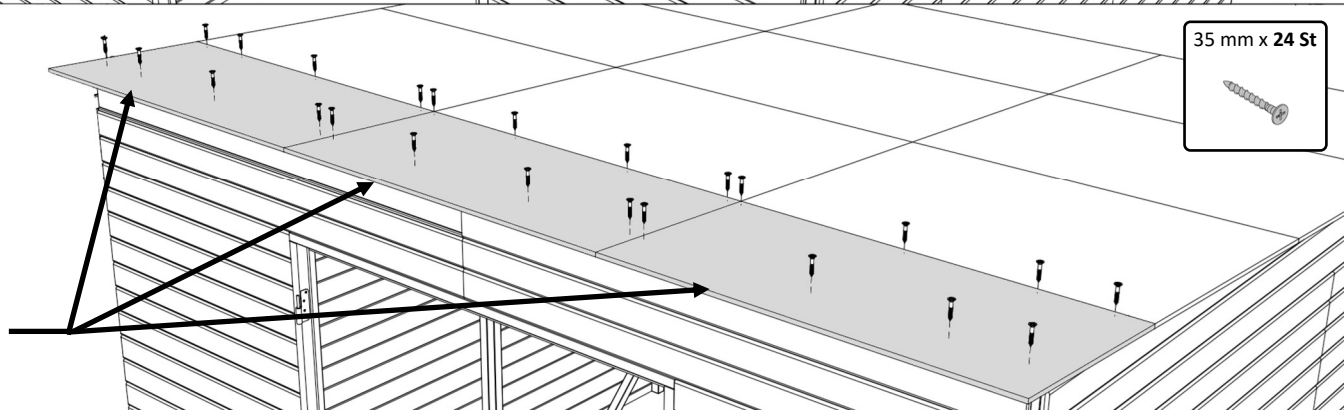

BCBAL2(NF)

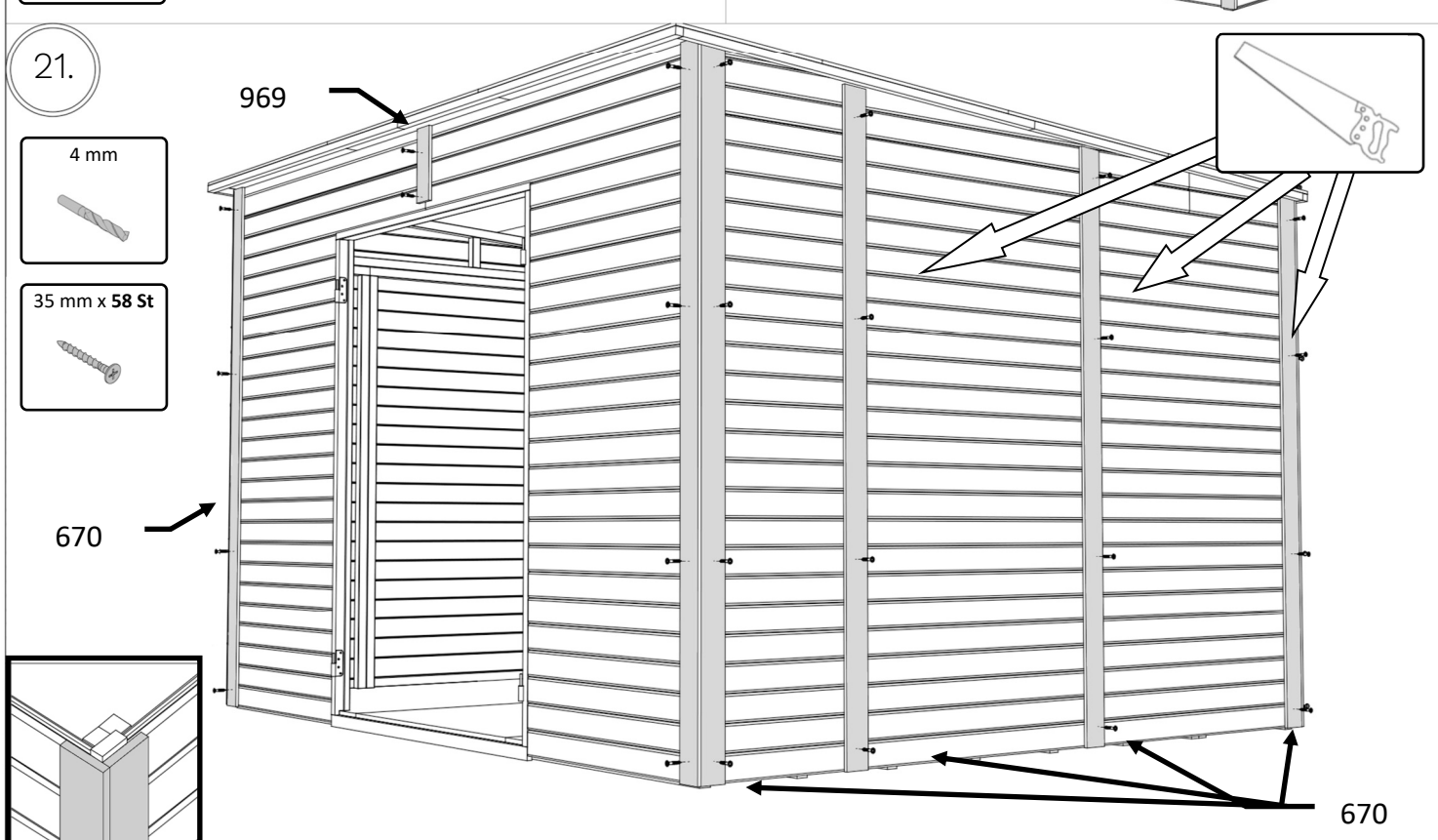
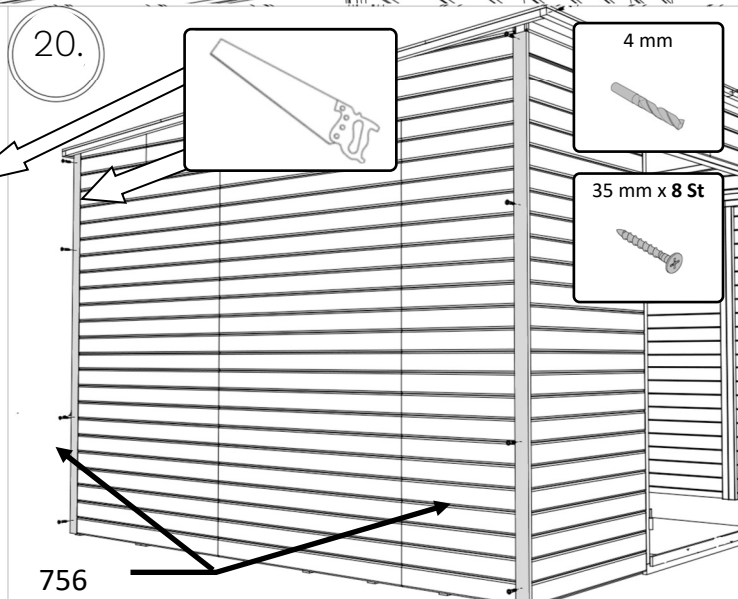
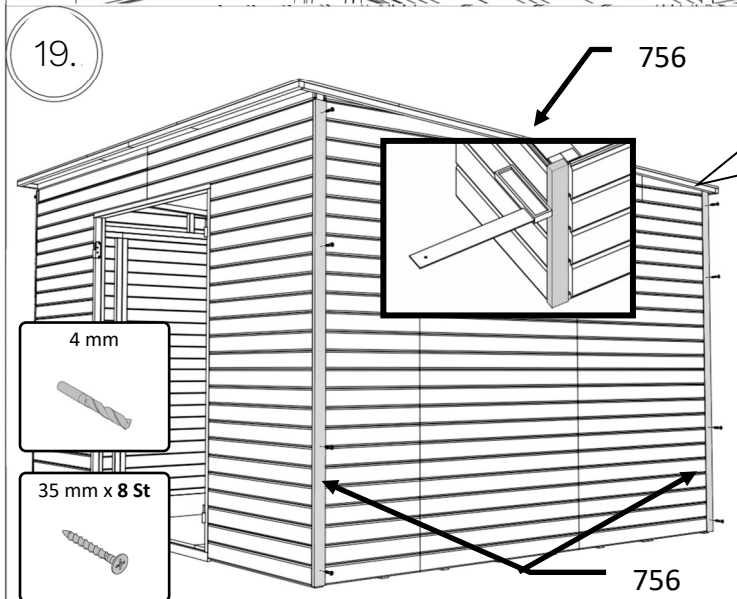
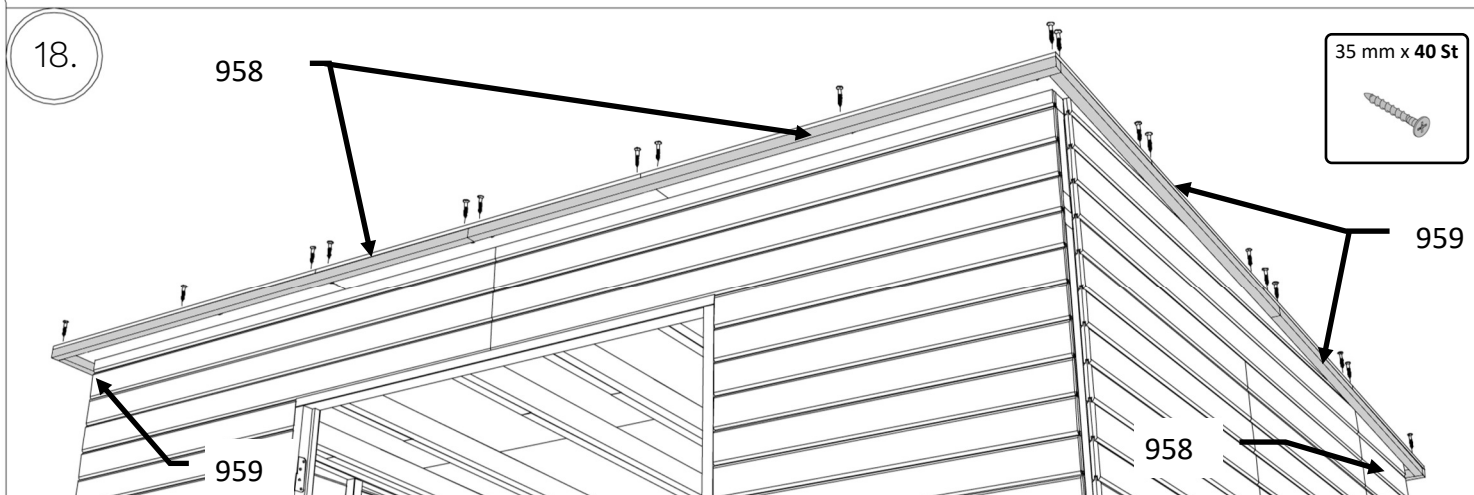

BCBAL2(NF)

22.

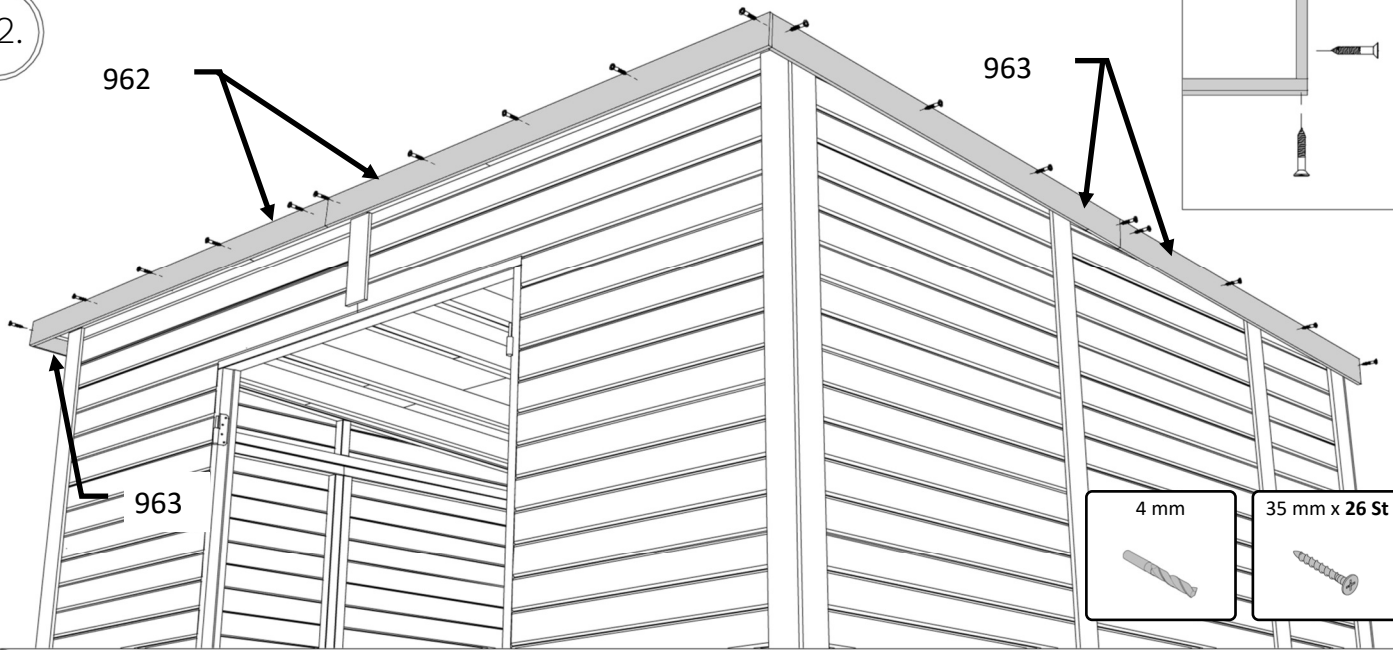

23.

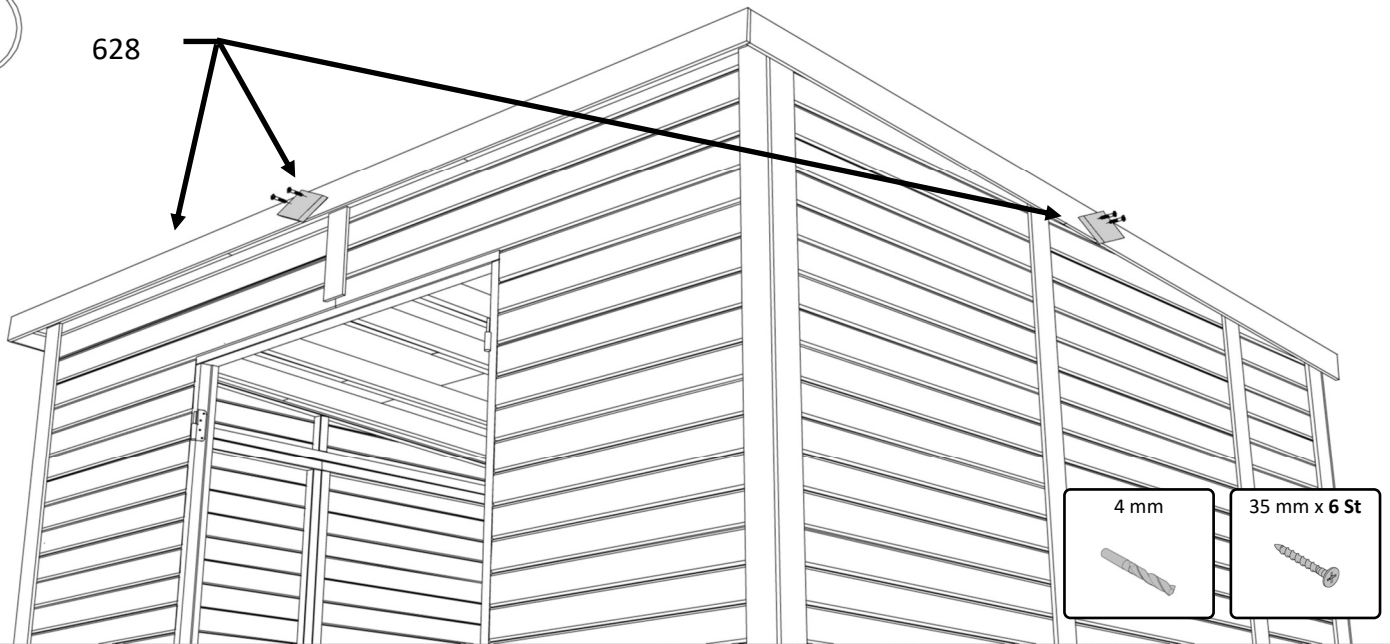

24.

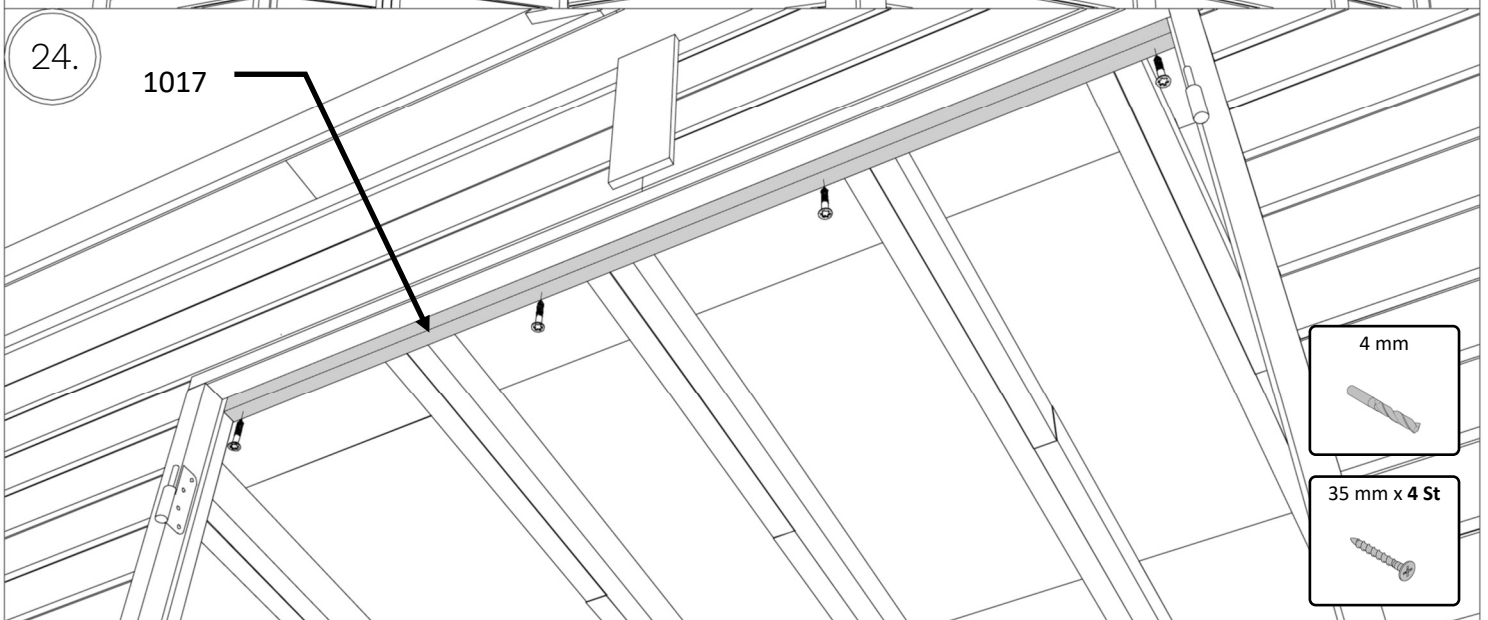

BCBAL2(NF)

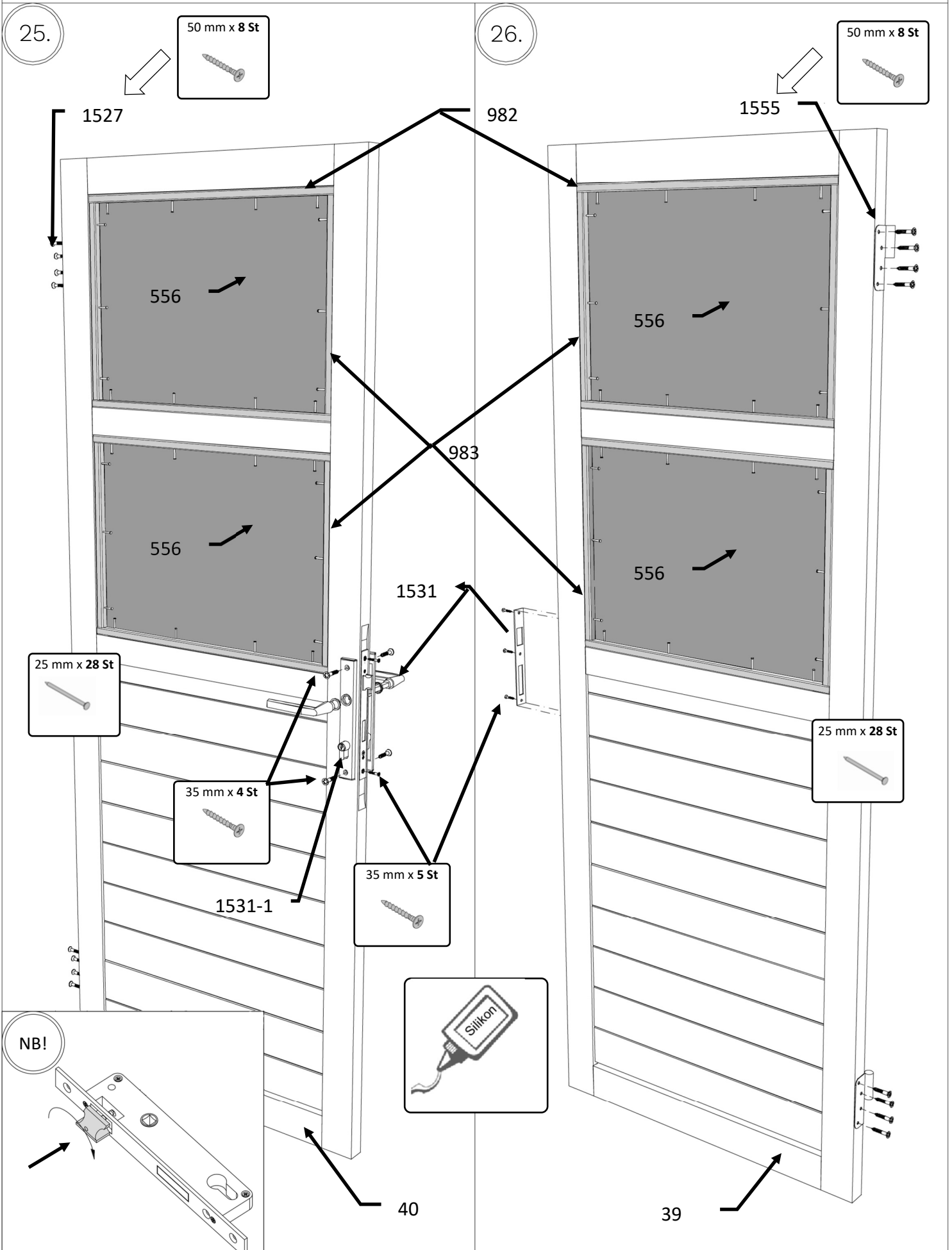

BCBAL2(NF)

27.

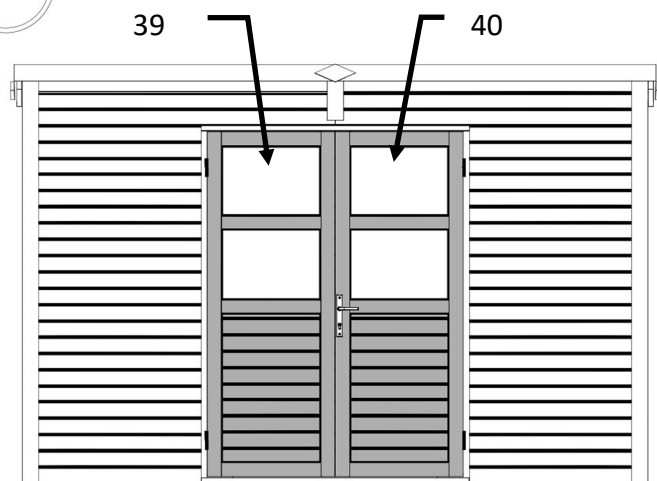

28.

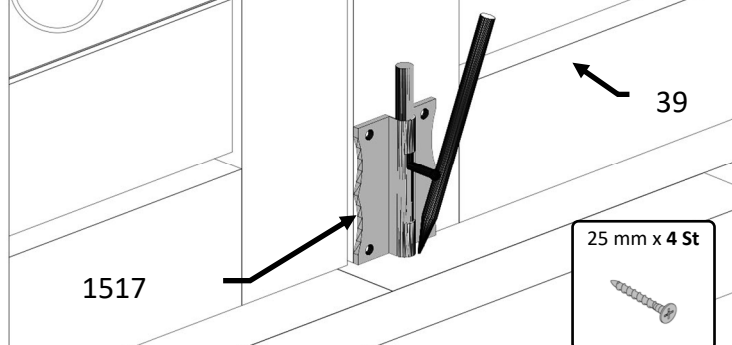

29.



30.

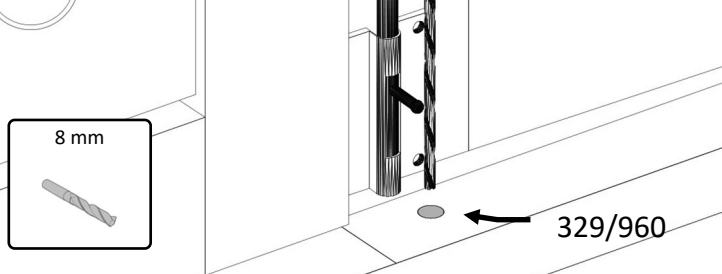

31.

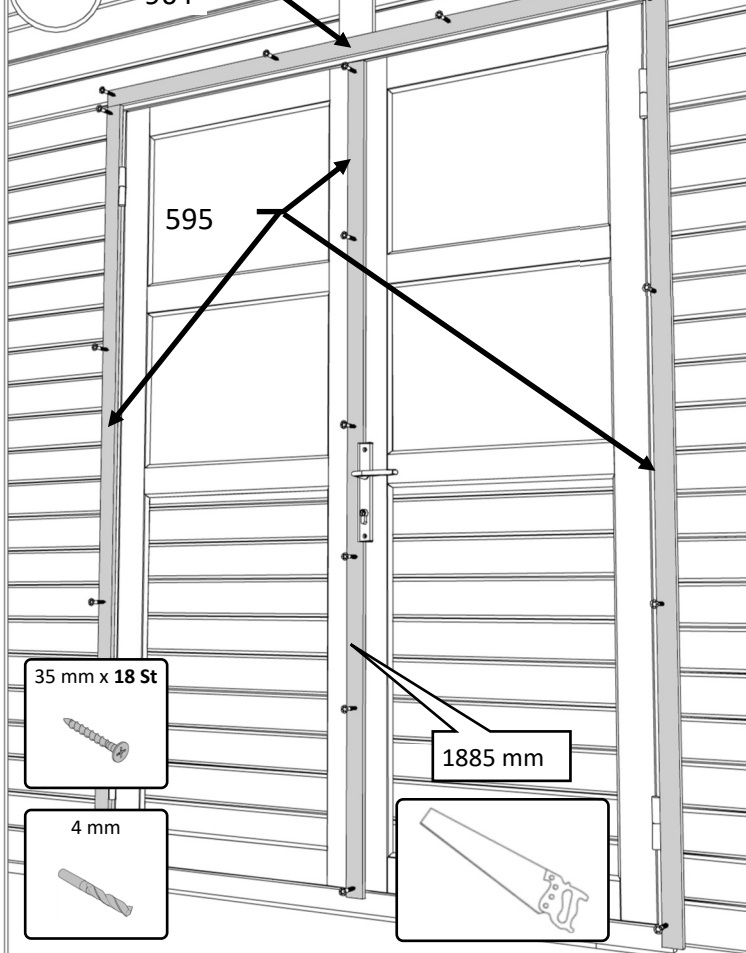

32.

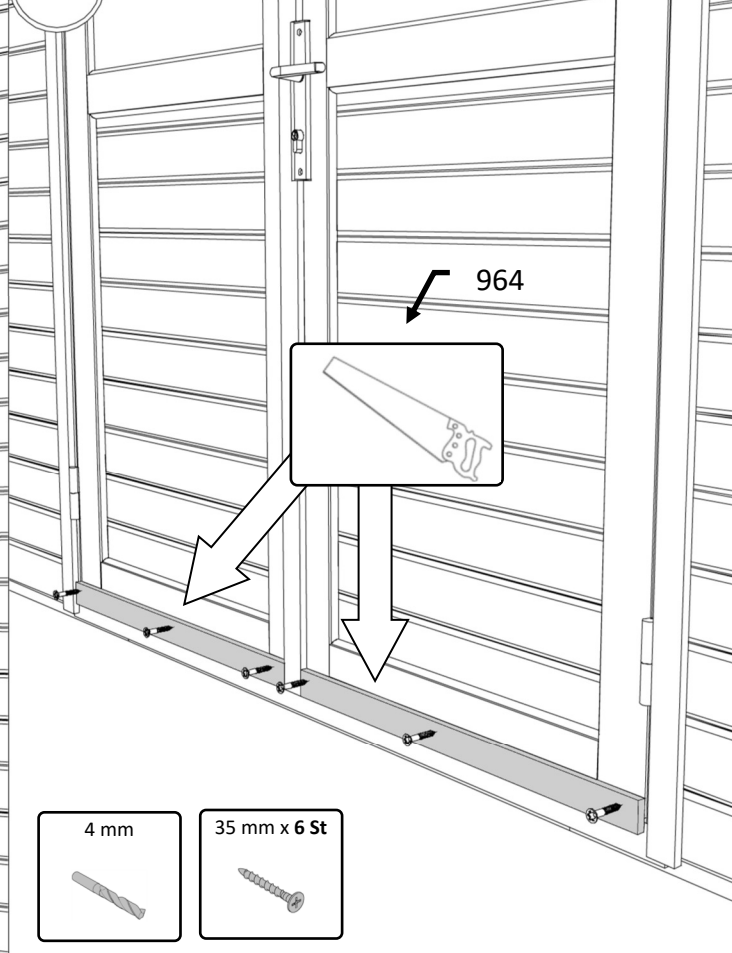

BCBAL2(NF)

Version 1.

1.

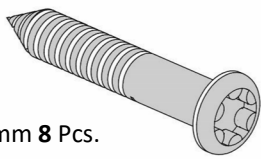

Ø3 x 19 mm 8 Pcs.

1557 2 Pcs.

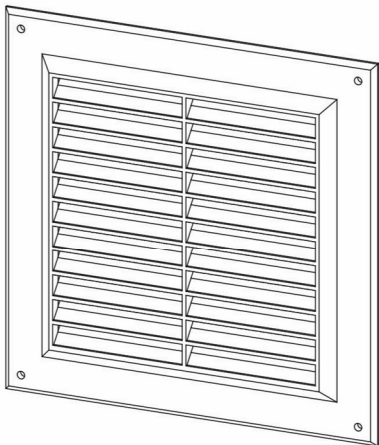

2.

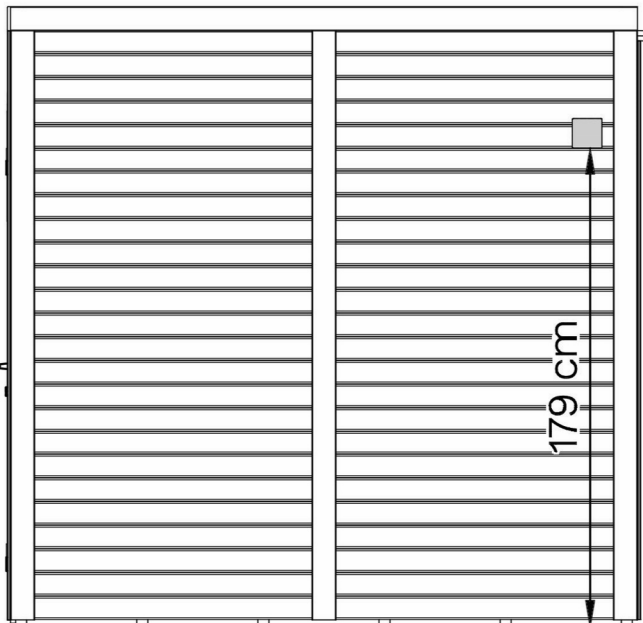

179 cm

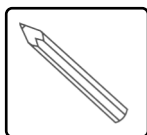

3.

8 mm



110 mm

110 mm

4.

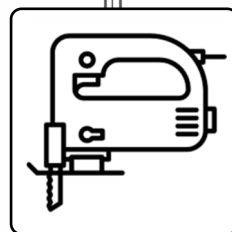

5.

Silikon



6.

19 mm x 4 St



19 mm x 4 St



BCBAL2(NF)

Version 2.

1.

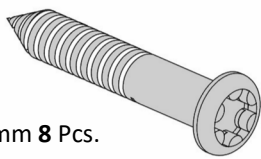

Ø3 x 19 mm 8 Pcs.

1557 2 Pcs.

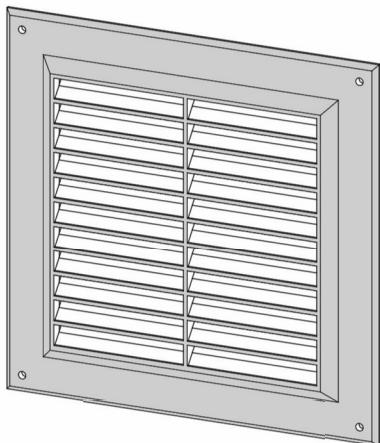

2.

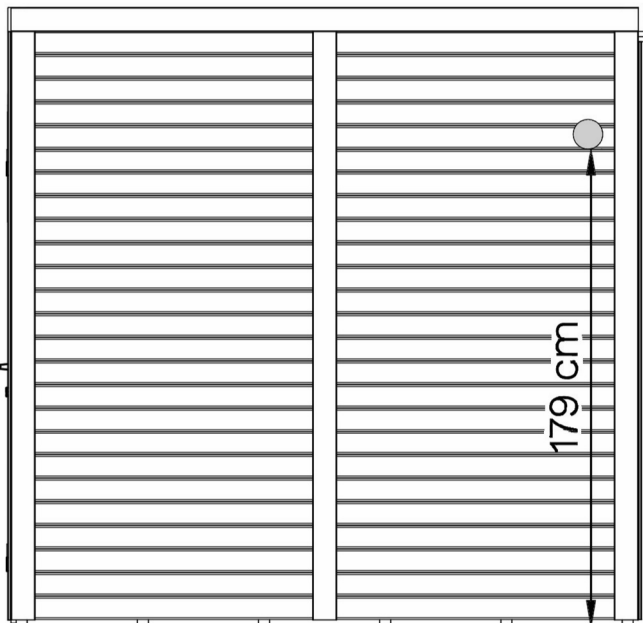

179 cm

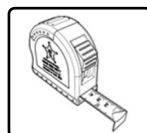
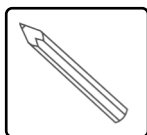

3.

8 mm



110 mm

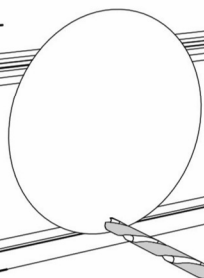

4.

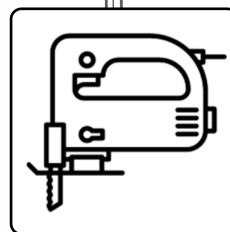

5.

Silikon



19 mm x 4 St

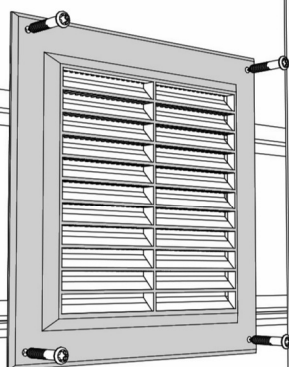

6.

19 mm x 4 St

