

## KLUDI FLEXX.BOXX

One concealed box for all applications

NEW



**KLUDI FLEXX.BOXX**  
Maximum flexxibility

## KLUDI FLEXX.BOXX

A name – a promise of performance



## Even easier, quicker and safer

KLUDI FLEXX.BOXX the name says it all, now more than ever. It is fully flexible to use and all you need is one flush mounted box for all applications – whether it is a thermostat, single lever mixer or a protection against backflow.

If necessary and upon request you can wait until last minute to choose the appropriate KLUDI tap, as the pre-assembled functional unit will be delivered with the back plate.

The brand new FLEXX.BOXX is available from now on with an integrated checking and rinsing unit. This saves time for the installation.

Furthermore, the integrated rinse set allows a higher water flow and therefore a faster and more thorough rinsing process.

It is guaranteed to have an even more comfortable rinsing process in accordance to DIN 1988.

FLEXX.BOXX combines new advantages with best KLUDI quality and is ideal for modern flush mounted installation.

## Maximum flushing comfort

The KLUDI FLEXX.BOX is fully watertight and ready to install. The plumbing and the connection to the box can be tested for watertightness as soon as it has been installed.

The FLEXX.BOX contains an integrated flushing set for the convenient flushing of internal plumbing.



As soon as you take off the cover for the final installation you can see the flushing set and the glass fibre-reinforced plastic plate. The high quality material, developed for automobile construction, has proved its stability in extensive tests at temperatures ranging from +90 °C to -18 °C. During the watertightness test the pressure can therefore be left at a maximum of 16 bar throughout the whole plumbing system.

Once the Elastomere coating has been shortened you can remove the from the box, loosen the stainless steel screw and simply pull the flushing set up and out.

The flushing set is reusable.

## Maximum structural protection



During the entire construction phase the cover stays on the KLUDI FLEXX.BOXX. This means that no dirt can get into the unit and the seal faces inside are protected from damage. The original KLUDI seal is a visible sign of this construction protection.

The platform that is later assimilated into the unit has a precision-engineered seal face. This is made of



dezincification-resistant (DZR) brass and has external DN 20 connections that are tested by KLUDI for watertightness.

As a concealed box the FLEXX.BOXX has similar properties to a tap. In other words, it can be subjected to water pressure for many months following installation: a requirement that has to be complied with, particularly in the case of larger construction projects.

## Maximum watertightness

The watertight Elastomere coating acts as an intelligent sealing system that surrounds the water-bearing parts. Any condensation that arises inside the FLEXX.BOXX is drained out onto the front of the tiles. Included with the unit is a seal that provides long term protection against leakage.



## Maximum adjustability

The flexible Elastomere coating is one of the tried and tested features of the FLEXX.BOXX. The ring-shaped central folds allow it to fit effortlessly onto any wall. This makes both concealed and out-wall installation easier on uneven surfaces.



## Maximum compatibility



Universal attachments mean that the KLUDI FLEXX.BOXX can be fixed as classic concealed installation or as out-wall or front-wall installation. It can also be installed in prefabricated houses or wet rooms.

The FLEXX.BOXX is also compatible with all conventional and flexible plumbing systems. The external connections leave enough space for the plumbing connections to be easily grouted.

All connections are set up for DN 20, which means that high rates of flow can be achieved. The large connection sizes mean that in the shower, in particular, many combinations of head, hand and side shower units are possible.

## Maximum sound insulation



None of the water-bearing components have any direct contact with the wall. They are totally enclosed by the Elastomere coating, which absorbs the sound of running water before it can reach the wall.

## Maximum convertibility



The flexible benefits of the KLUDI FLEXX.BOXX include the possibility of exchanging both the unit and the trim set at any time – even after installation – without any dirt or elaborate structural work.

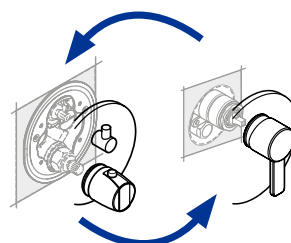

It is possible to convert from a single lever mixer to a thermostat or vice versa at any time.

# Tried and tested quality – new benefits



**Flexible wall installation**  
Installation on uneven surfaces possible



**Intelligent seal system**  
Protection from condensation and splashwater

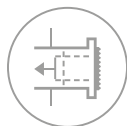

**Single unit**  
Elastomere coating and water-bearing parts form a single unit



**Sound insulation**  
The noise of flowing water is not carried through the wall

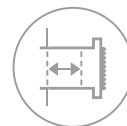

**Installation depth**  
Arrows marked on the Elastomere coating show the optimum installation depth of 80 to 110 mm

## Wall installation



Align and screw in



Connect up



Trim and affix seal

## Maximum ease of installation

## Final installation



Remove assembly pipe

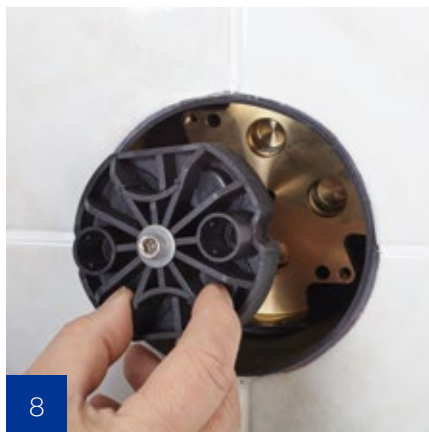

Simply lift out flushing set

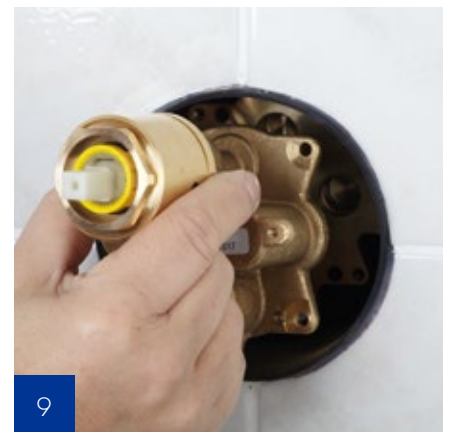

Install unit





4

Tile



5

Flush in accordance with DIN 1988 using integrated flushing set



6

Trim to size – the inside of the box remains protected from dirt during the entire construction phase



Simple. Quick. Safe.



10

Install trim set



11

Affix rosette attachment



Ready!

The film: the new FLEXX.BOXX live.  
Watch a step by step demonstration of how simple it is to install the new FLEXX.BOXX. Simply scan the QR code or click on the FLEXX.BOXX film at [www.flexboxx.com](http://www.flexboxx.com)



# One FLEXX.BOXX for all applications





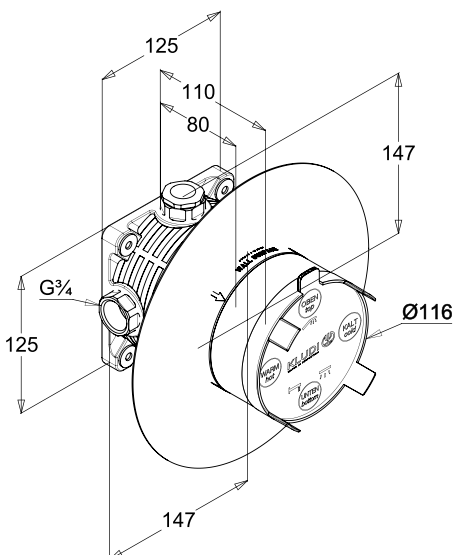

































**88011**  
**KLUDI FLEXX.BOXX**  
**concealed unit DN 20**  
concealed construction set  
without trim set, without unit,  
concealed installation with  
one-piece Elastomere coating,  
with construction protective cap,  
with additional seal, with flushing  
set, platform made from  
DZR brass P-IX 19310/ICB



Series availability	KLUDI AMEO	KLUDI AMBA	KLUDI E2
	 416500575	 536500575	 496500575
Unit single lever mixer	 416550575	 536550575	 496550575
	 418300575	 538300575	 498300575
Unit thermostatic mixer	 418350530	 538350575	 498350575
	 416570575	 536570575	
Unit single lever mixer protected against backflow			
		 537290575	 497290575
Unit thermostatic mixer			

Series availability	KLUDI PUSH	KLUDI PUSH
	 388010538	 388020538
Unit thermostatic mixer for one outlet		
	 388110538	 388120538
Unit thermostatic mixer for two outlets		
	 386010538	 386020538
unit single lever mixer for one outlet		
	 386110538	 386120538
unit single lever mixer for two outlets		

KLUDI BALANCE	KLUDI Q-BEO	KLUDI MX	KLUDI O-CEAN	KLUDI BOZZ	KLUDI ZENTA	KLUDI OBJEKTA	KLUDI TERCIO	KLUDI PROVITA
 52650..75	 506500575	 336500562	 387500575	 386500576	 38650..75	 326500575	 386510575	 336500500
 52655..75	 506550575	 336550562	 387550575	 386550576	 38655..75	 326550575		 336550500
 52830..75	 508300542	 358300538	 388300545		 388300545	 358300538	 386560575	
 52835..75	 508350542	 358350538	 388350545		 388350545	 358350538		
 52657.75	 336570562	 387570575	 386570576	 386570575	 326570575			

## KLUDI FLEXX.BOXX

### Maximum flexibility

#### ACCESSORIES

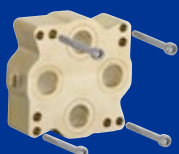

**7300600-00**  
Concealed extension for trim sets, suitable for 88011 KLUDI FLEXX.BOXX; an extension kit for all applications



**7458000-00**  
Adaptor for wrong installed function part for KLUDI FLEXX.BOXX single lever variants



**7400100-00**  
Adaptor for wrong installed function part for KLUDI FLEXX.BOXX thermostatic variants





99202841603/VO/02.17

Kludi GmbH & Co. KG  
P.O. Box 2560 · 58685 Menden  
Am Vogelsang 31–33 · 58706 Menden  
Germany

T +49 2373 904-0  
F +49 2373 904-465  
E [international-sales@kludi.com](mailto:international-sales@kludi.com)

[kludi.com](http://kludi.com)