

TIROL 70
Art.No. 7012144

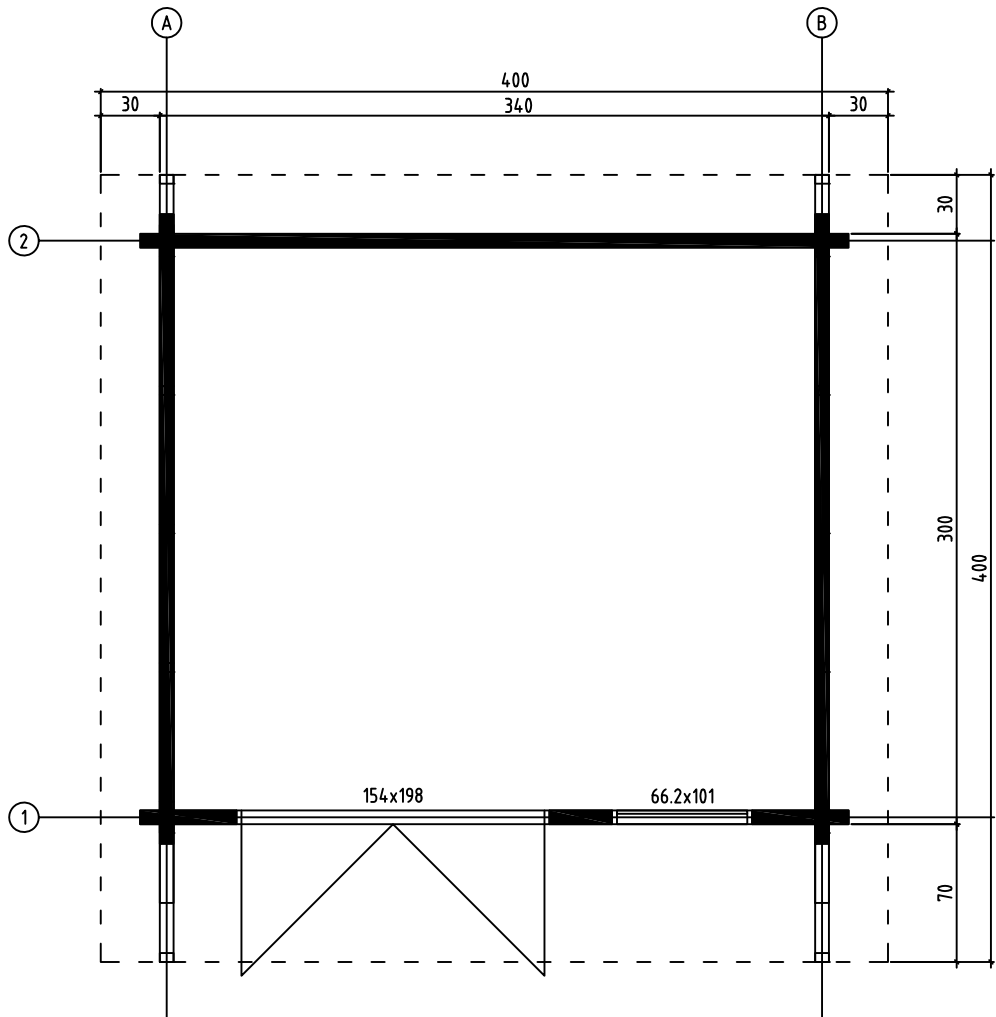

TIROL 70, Art.No.7012144
 GRUNDPLAN - GRUNDPLAN - PLAN DE MASSE



FOUNDATION - FUNDAMENT - FONDATION

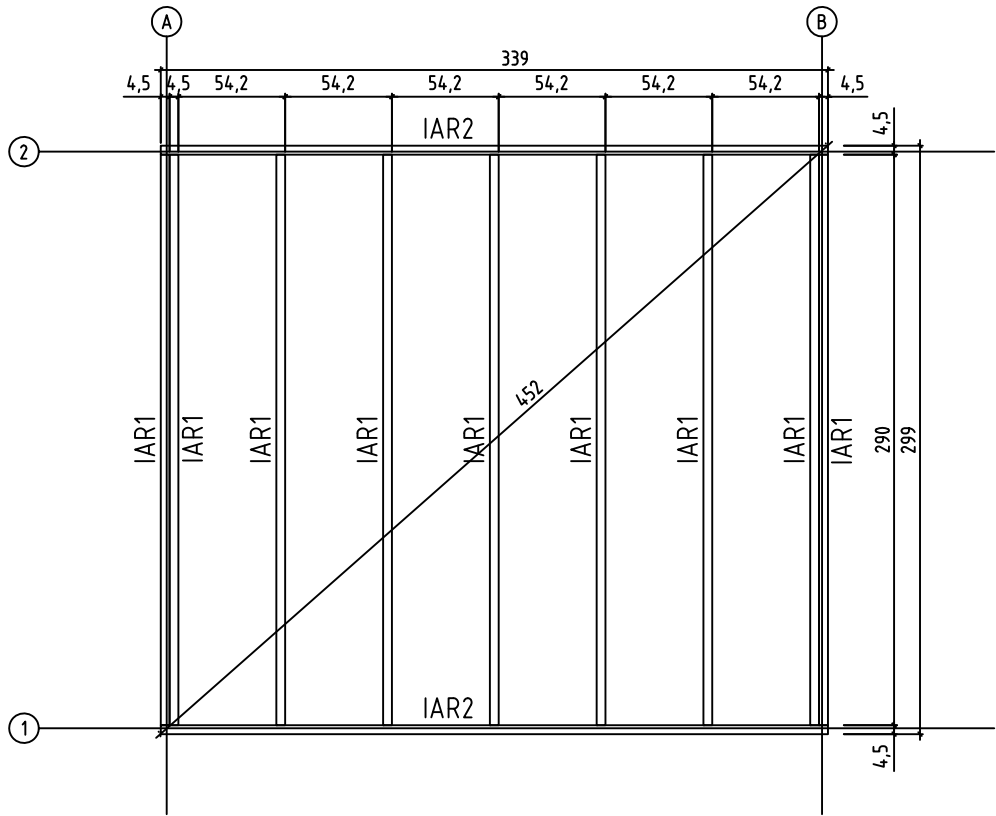

TIROL 70, Art.No.7012144
RAFTERS PLAN - DACHSPARREN - PLAN DE CHEVRON

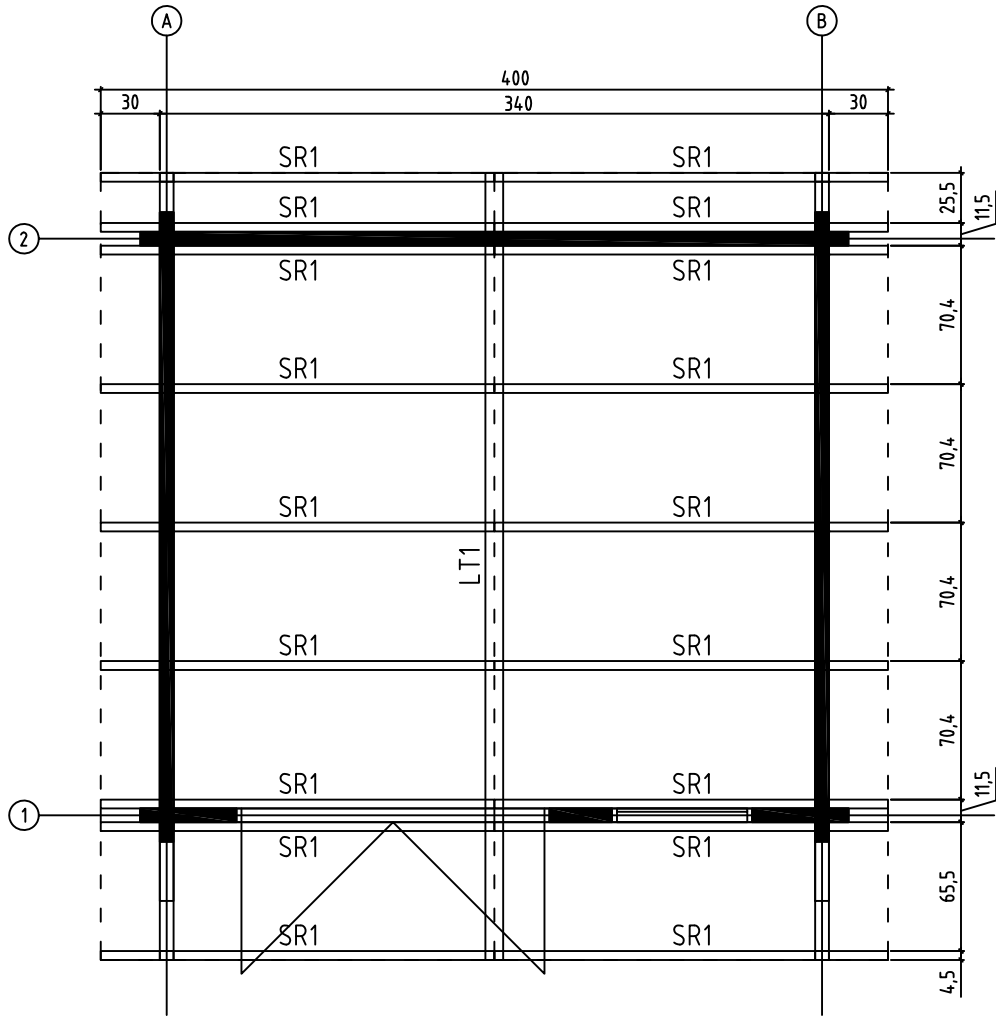



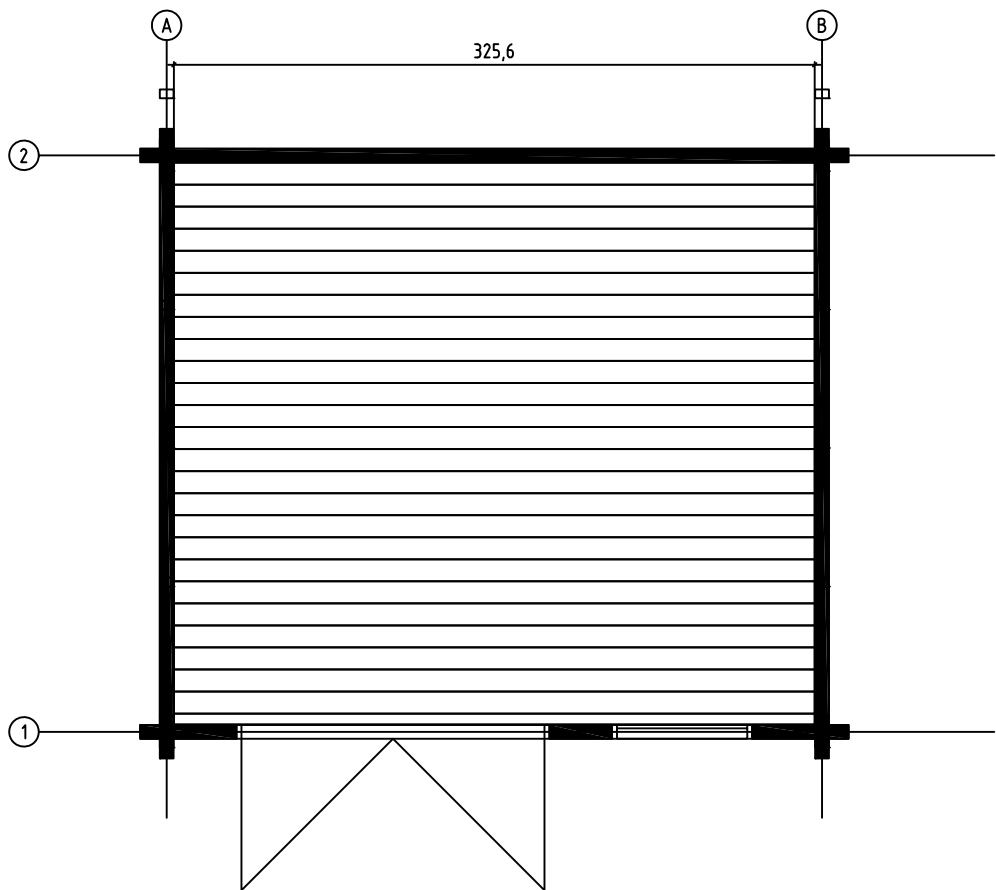

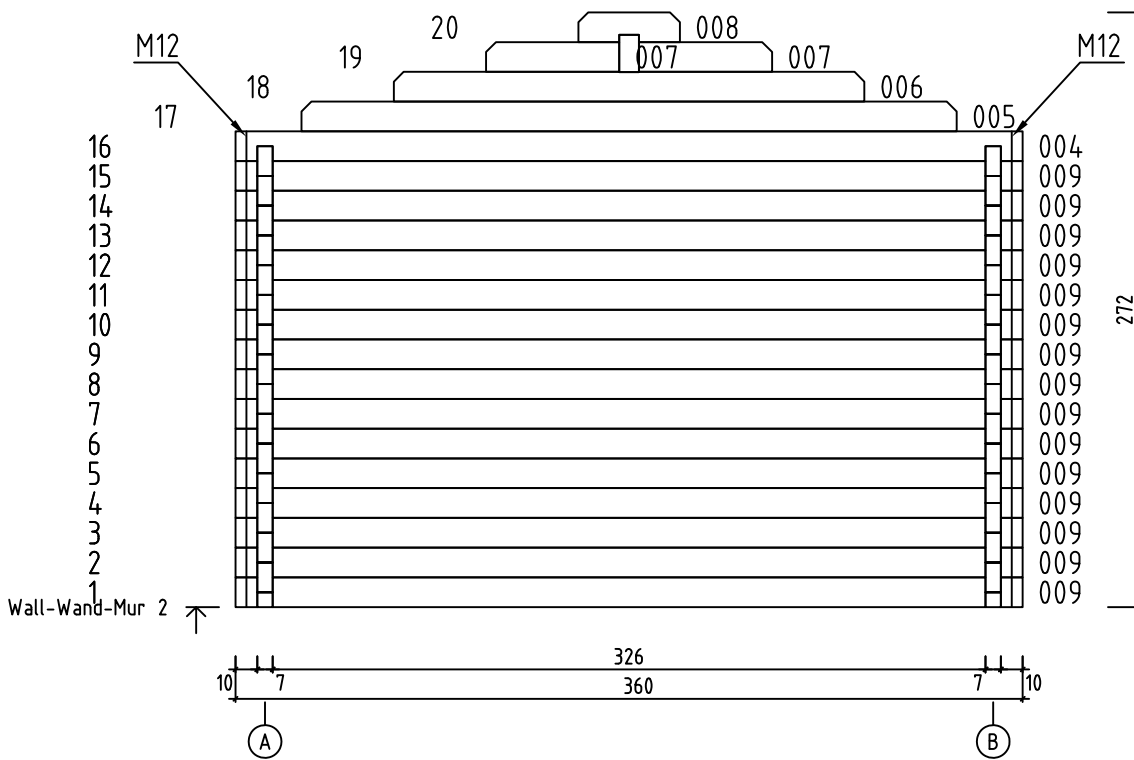
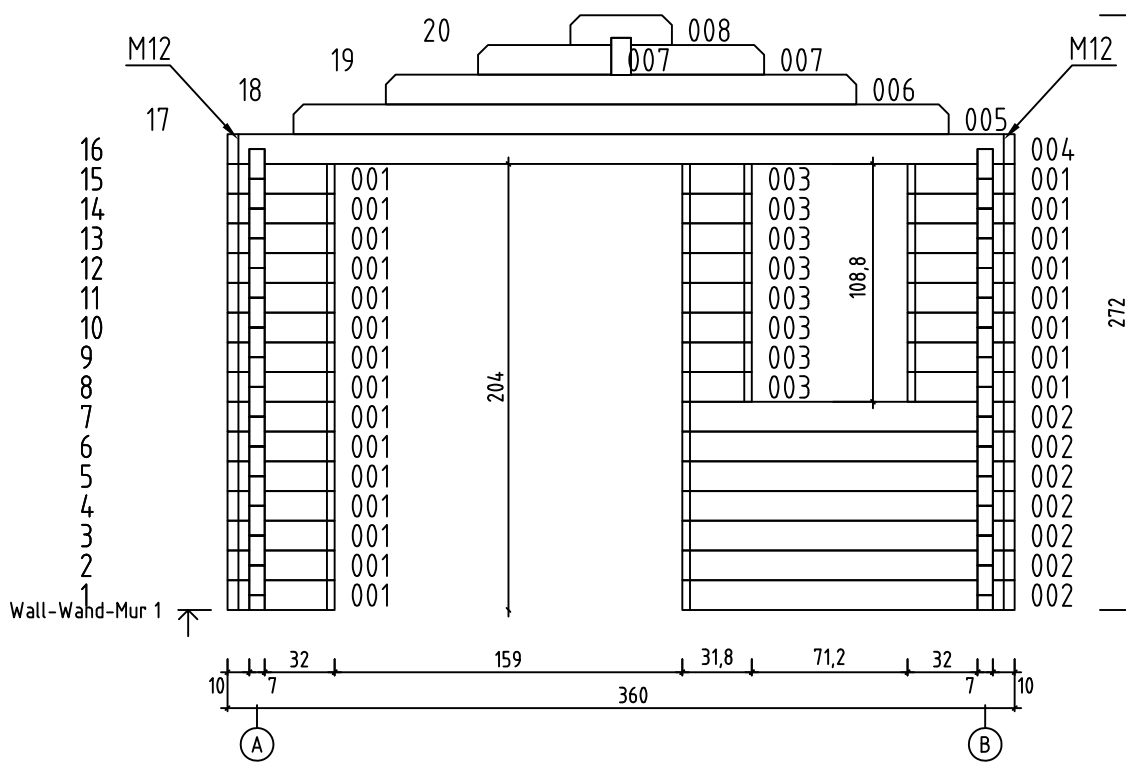

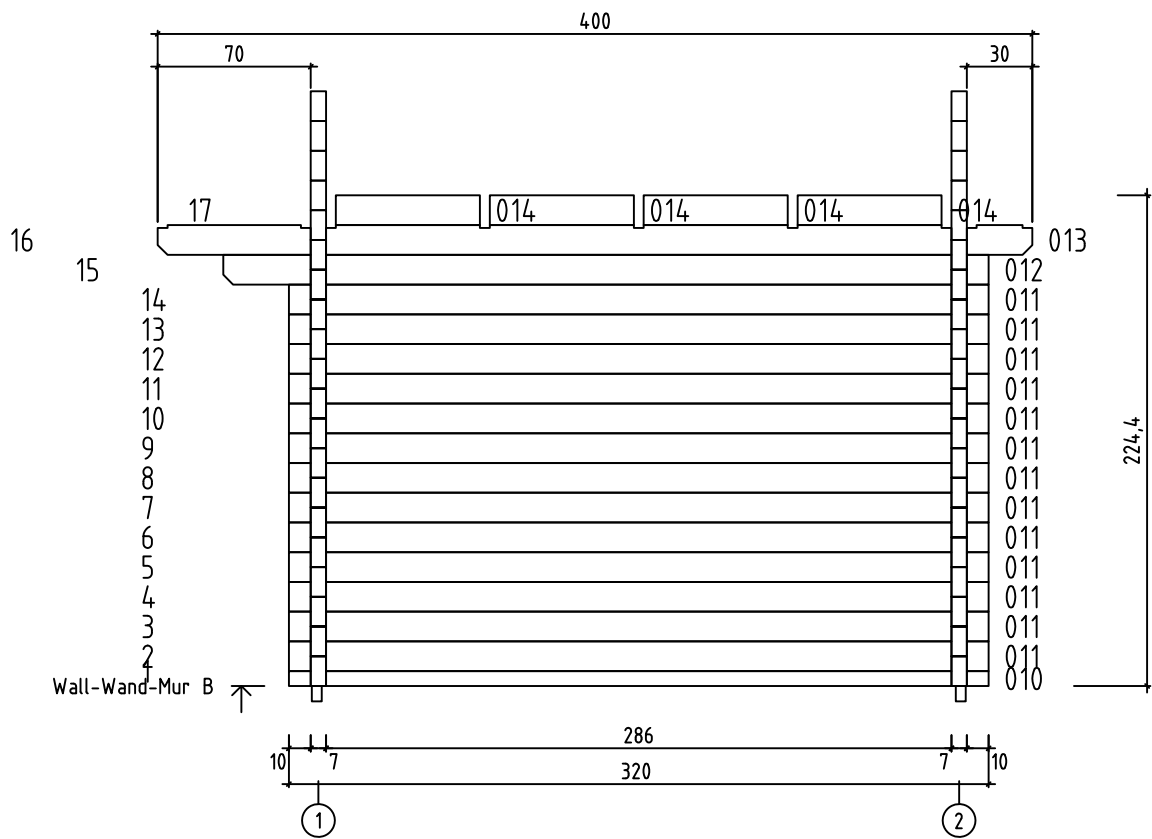
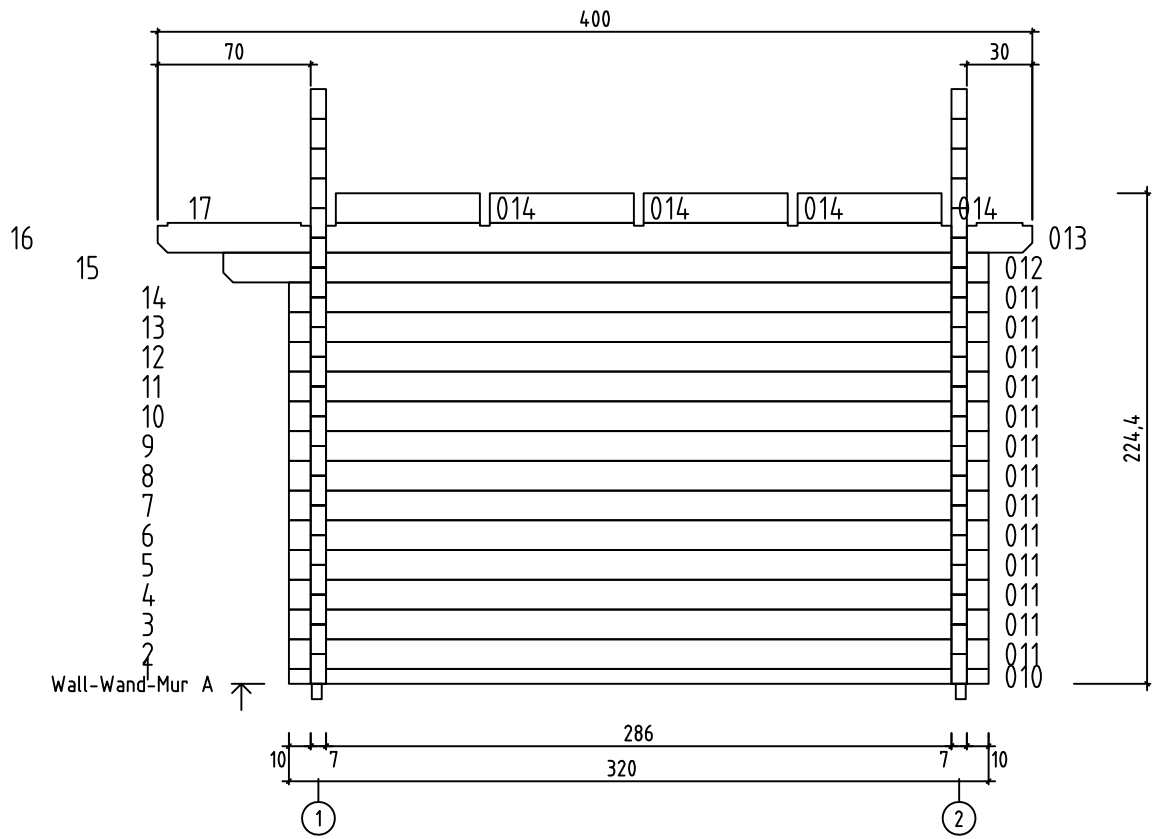

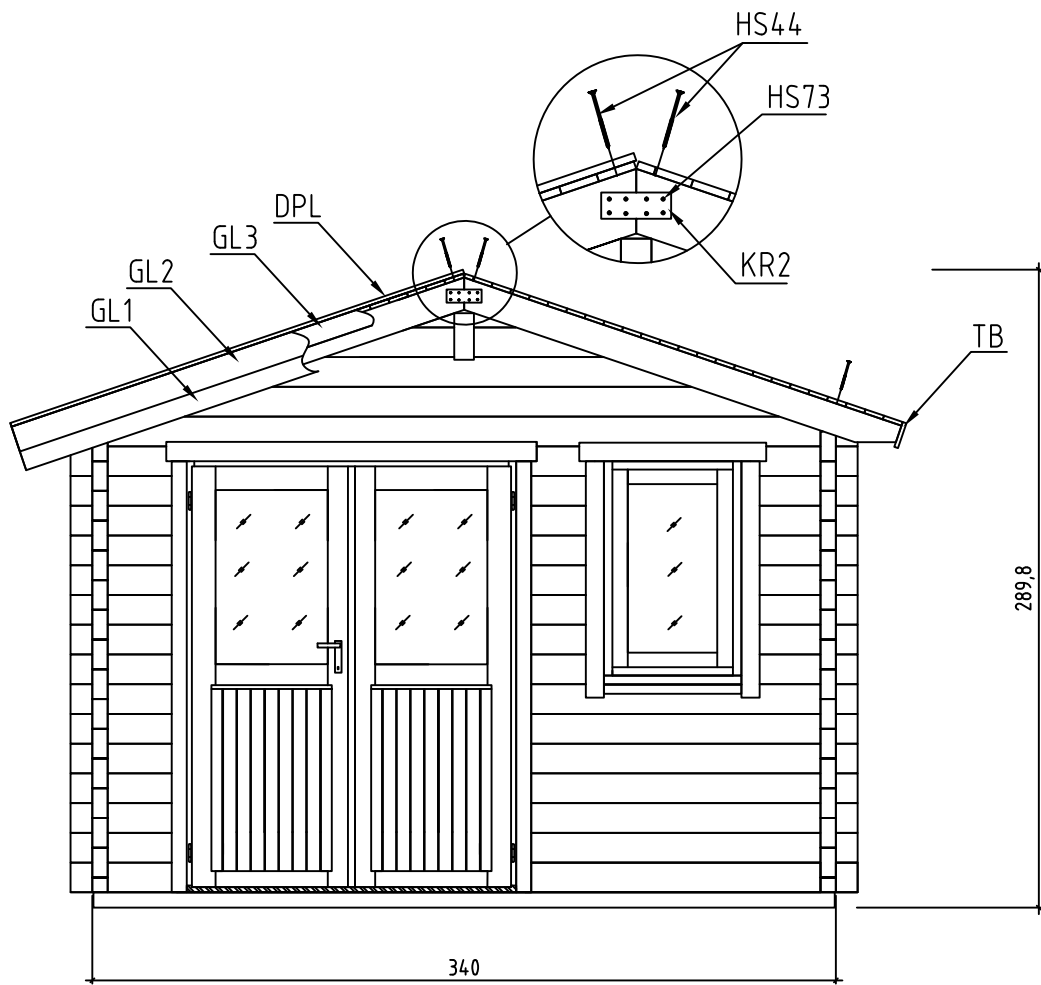

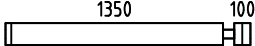

FLOOR BOARDS - FUSSBODENBRETTER - PLAN POSE PLANCHER

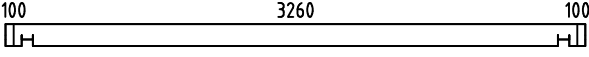
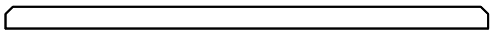
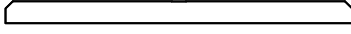
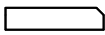

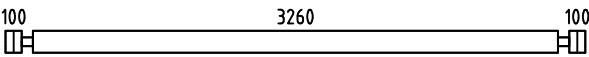
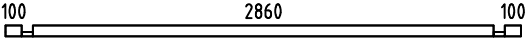
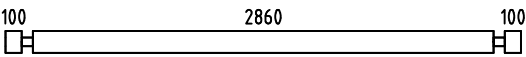
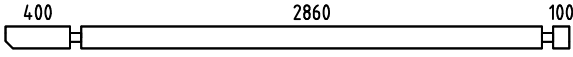
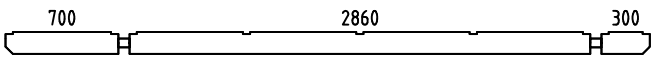
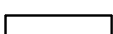
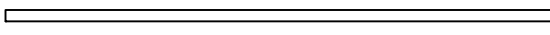
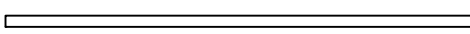
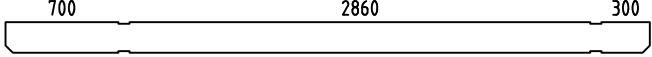
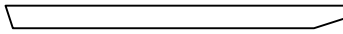
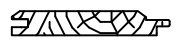
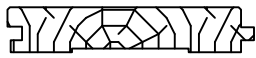











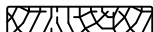



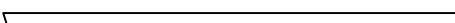

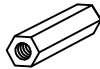



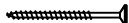
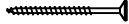
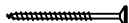

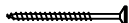

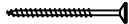
Pos	TIROL 70, Art.No.7012144 Piece list - Stückliste - Liste des pieces	Q.	P (mm)	L (mm)
001		23	70x136	490
002		7	70x136	1520
003		8	70x136	318
004		2	70x136	3600
005		2	70x136	2996
006		2	70x136	2152
007		4	70x136	609
008		2	70x136	464
009		15	70x136	3600
010		2	70x68	3200
011		26	70x136	3200
012		2	70x136	3500
013		2	70x136	4000
014		8	70x136	659
IAR2	FOUNDATION - FUNDAMENT - FONDATION 	2	45x70	3390
IAR1	FOUNDATION - FUNDAMENT - FONDATION 	9	45x70	2900
LT1	RIDGE BOARD - DACHPFETTEN - FAITAGE 700 2860 300 	1	90x190	4000
SR1	RAFTER - DACHSPARREN - CHEVRON 	18	45x140	2101
STP	CEILING BOARDS - DECKENBRETTER - VOLIGES SOUS PLAFOND 	30	111x15	2856
PTL	FLOOR BOARDS - FUSSBODENBRETTER - LAME DE PLANCHER 	26	112x28	3256
	ROOF BOARDS - DACHBRETTER - VOLIGES 	48	90x18	4000
LL	CEILING FILLET - DECKELEISTE - PROFIL DE FINITION POUR SOUS PLAFOND 		15x40	18.1 m.
	FLOOR FILLET-FUSSBODENLEISTE - CORNIERE DE FINITION DU PLANCHER 		15x40	12.2 m.
DPL	ROOFING FELT FILLET - DACHPAPPENLEISTE - BAGUETTE DE FIXATION DU FEUTRE BITUMEUX 	4	18x58	2186
M12	TREADED ROD M12 - GEWINDESTANGE M12 - TIGE FILETÉE M12 	4		206

Pos	TIROL 70, Art.No.7012144 Piece list - Stückliste - Liste des pieces	Q.	P (mm)	L (mm)
M12	TREADED ROD M12 - GEWINDESTANGE M12 - TIGE FILETÉE M12 	4		2000
LPL	FIXING FILLET - FIXIRUNGSLEISTE - PROFIL DE FIXATION 	2	20x70	662
LPL	FIXING FILLET - FIXIRUNGSLEISTE - PROFIL DE FIXATION 	2	20x70	1050
LPL	FIXING FILLET - FIXIRUNGSLEISTE - PROFIL DE FIXATION 	1	20x70	1540
LPL	FIXING FILLET - FIXIRUNGSLEISTE - PROFIL DE FIXATION 	2	20x70	2000
TB	EAVES BOARD - TRAUFBRETT - BANDEAU DE TOIT 	2	18x120	4000
TBE6	FIXING FILLET FOR WINDOW - FIXIRUNGSLEISTE FÜR FENSTER - PROFIL DE FIXATION DES FENETRES 	2	28x34	1050
TBE6	FIXING FILLET FOR DOOR - FIXIRUNGSLEISTE FÜR TÜR - PROFIL DE FIXATION DES PORTES 	2	28x34	2000
GL3	GABLE MOULDING - GIEBELLEISTE PLANCHE DE RIVE 	4	18x90	2186
GL1	GABLE MOULDING - GIEBELLEISTE PLANCHE DE RIVE 	4	18x120	2155
GL2	GABLE MOULDING - GIEBELLEISTE PLANCHE DE RIVE 	4	18x120	2186
KL4	LENGTHENING BOLT FOR TREADED ROD - VERLÄNGERUNGSMUTTER FÜR GEWINDESTANGE - MANCHON DE RACCORDEMENT DE TIGE FILETÉE 	4		
KL1	DRIVE NUT TREADED ROD - EINSHLAGMUTTER FÜR GEWINDESTANGE - ÉCROU A FRAPPER POUR TIGE FILITÉE 	4		
KL2	NUT FOR TREADED ROD - MUTTER FÜR GEWINDESTANGE - ÉCROU POUR TIGE FILETÉE 	4		
KL3	PLAIN WASHER TREADED ROD - UNTERLEGSSCHEIBE FÜR GEWINDESTANGE - RONDELLE PLATE POUR TIGE FILETÉE 	4		
HS12	SCREW FOR GABLE SEGMENT - SCHRAUBEN FÜR DECKBLATT - VIS POUR FIXATION LOSANGE DE FINITION 	4	3.5x35	
HS83	SCREW FOR FIXING FILLET - SCHRAUBEN FÜR FIXIRUNGSLEISTE - VIS POUR PROFIL DE FIXATION 	29	3.5x50	
HS32	SCREW FOR EAVES BOARDS - SCHRAUBEN FÜR TRAUFBRETT - VIS DE FIXATION POUR BANDEAU DE TOIT 	36	3.5x50	
HS84	SCREW FOR FIXING FILLET - SCHRAUBEN FÜR FIXIRUNGSLEISTE - VIS POUR PROFIL DE FIXATION 	18	3.5x50	
HS16	SCREW FOR GABLE MOULDING - SCHRAUBEN FÜR GIEBELLEISTE - VIS DE FIXATION POUR PLANCHE DE RIVE 	72	3.5x50	
HS73	SCREW FOR CONNECTING PLATE - SCHRAUBE FÜR ANSCHLUSSPLATTE - VIS DE FIXATION DES PLAQUES DE CONNEXION 	72	4x40	
HS40	SCREW FOR 1. WALL BEAM - SCHRAUBE FÜR 1. BOHLENREIHE - VIS DE FIXATION DES FONDATIONS 	8	5x120	
HS39	SCREW FOR FUNDAMENT - SCHRAUBEN ZUR BEFESTIGUNG FUNDAMENT - VIS POUR FONDATION 	26	5x90	
HS48	SCREW FOR Pos. 014 - SCHRAUBEN FÜR Pos.014 - VIS DE FIXATION Pos.014 	16	6x180	
HS44	SCREW FOR RAFTER - SCHRAUBEN ZUR BEFESTIGUNG DACHSPARREN - VIS POUR CHEVRON 	36	6x180	

