

Missouri
Art.No. 702541

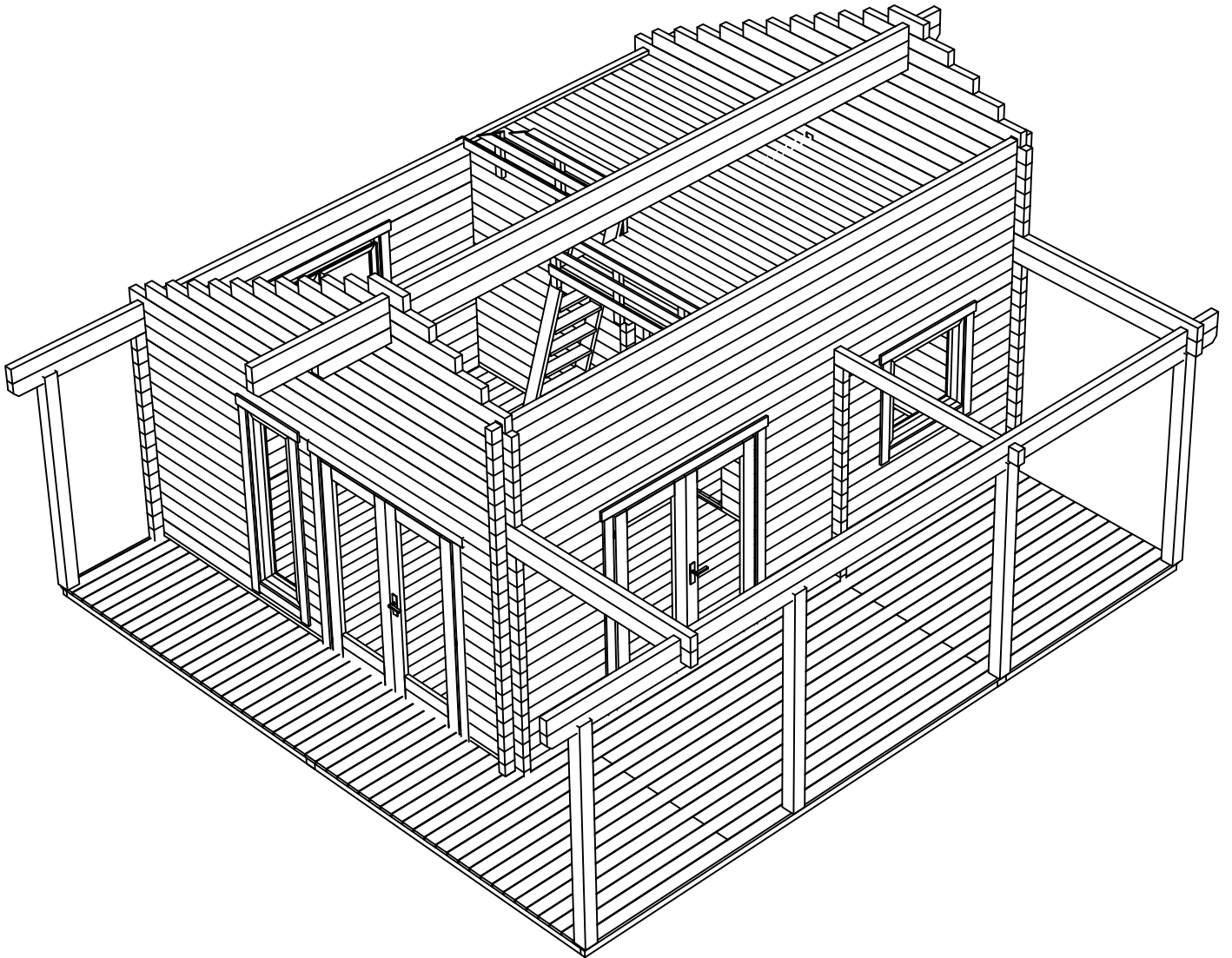

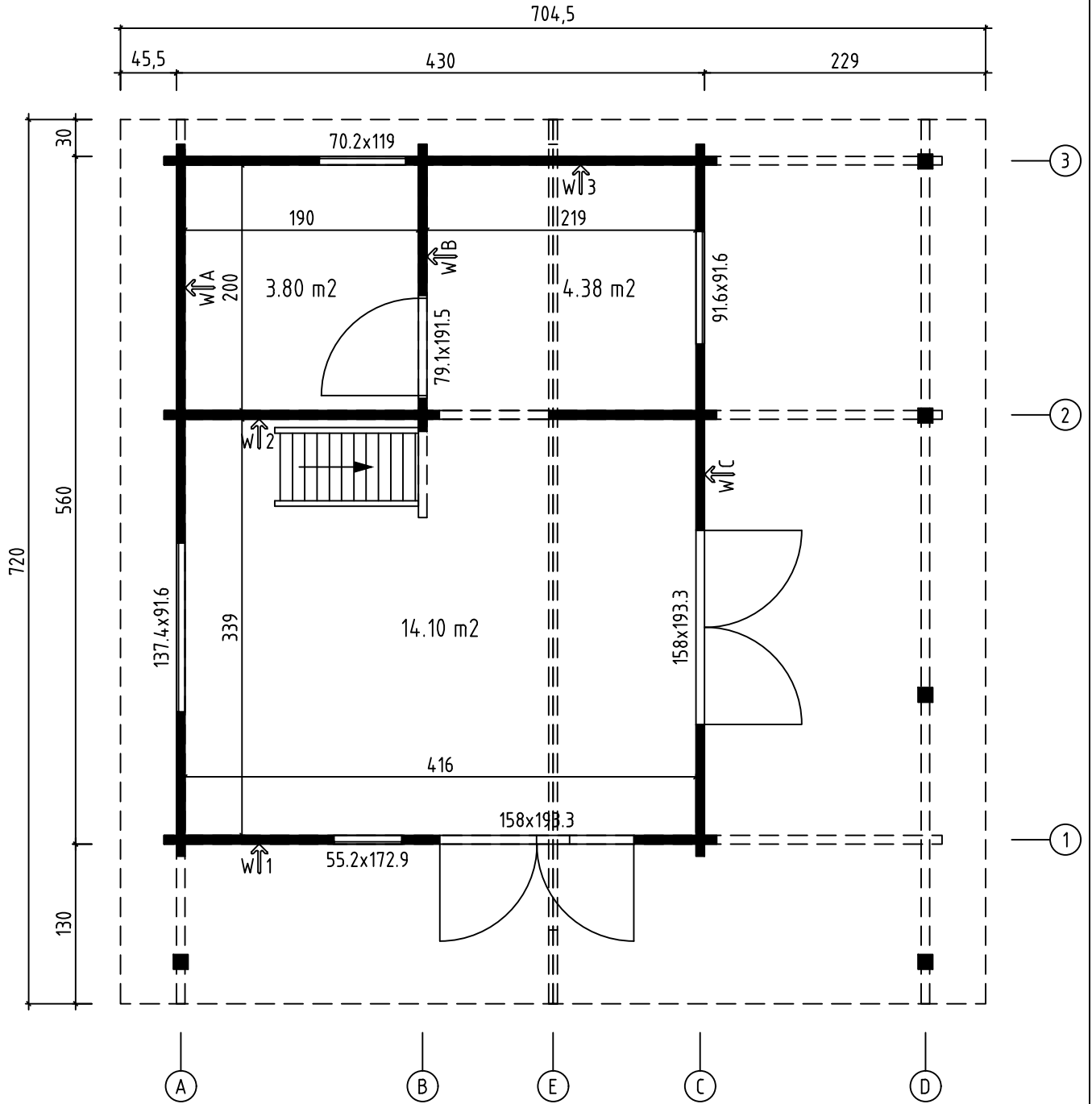

Missouri, Art.No.702541
GROUNDPLAN MEZZANINE - GRUNDPLAN HALBGESCHOSS - PLAN DE MASSE MEZZANINE

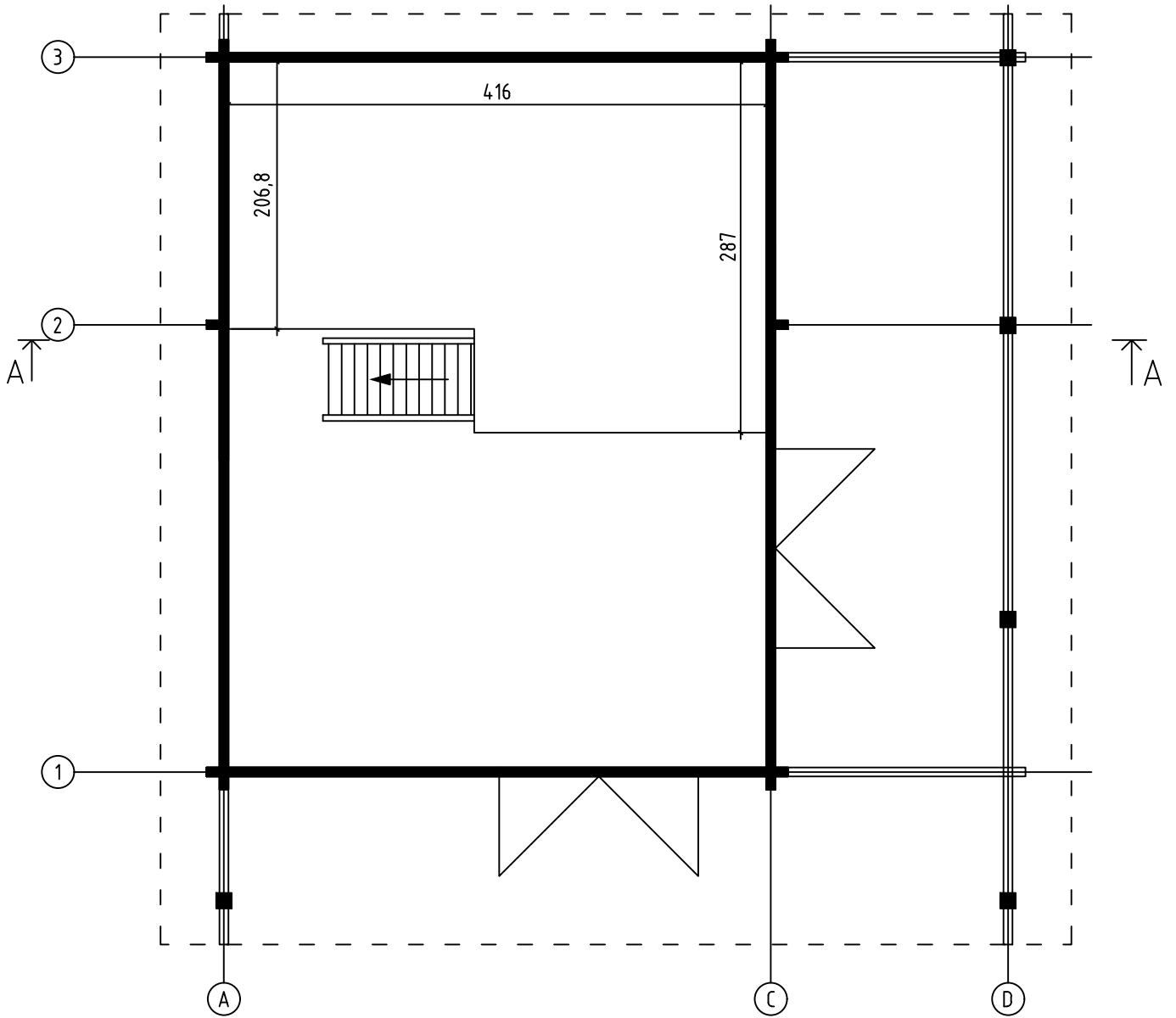

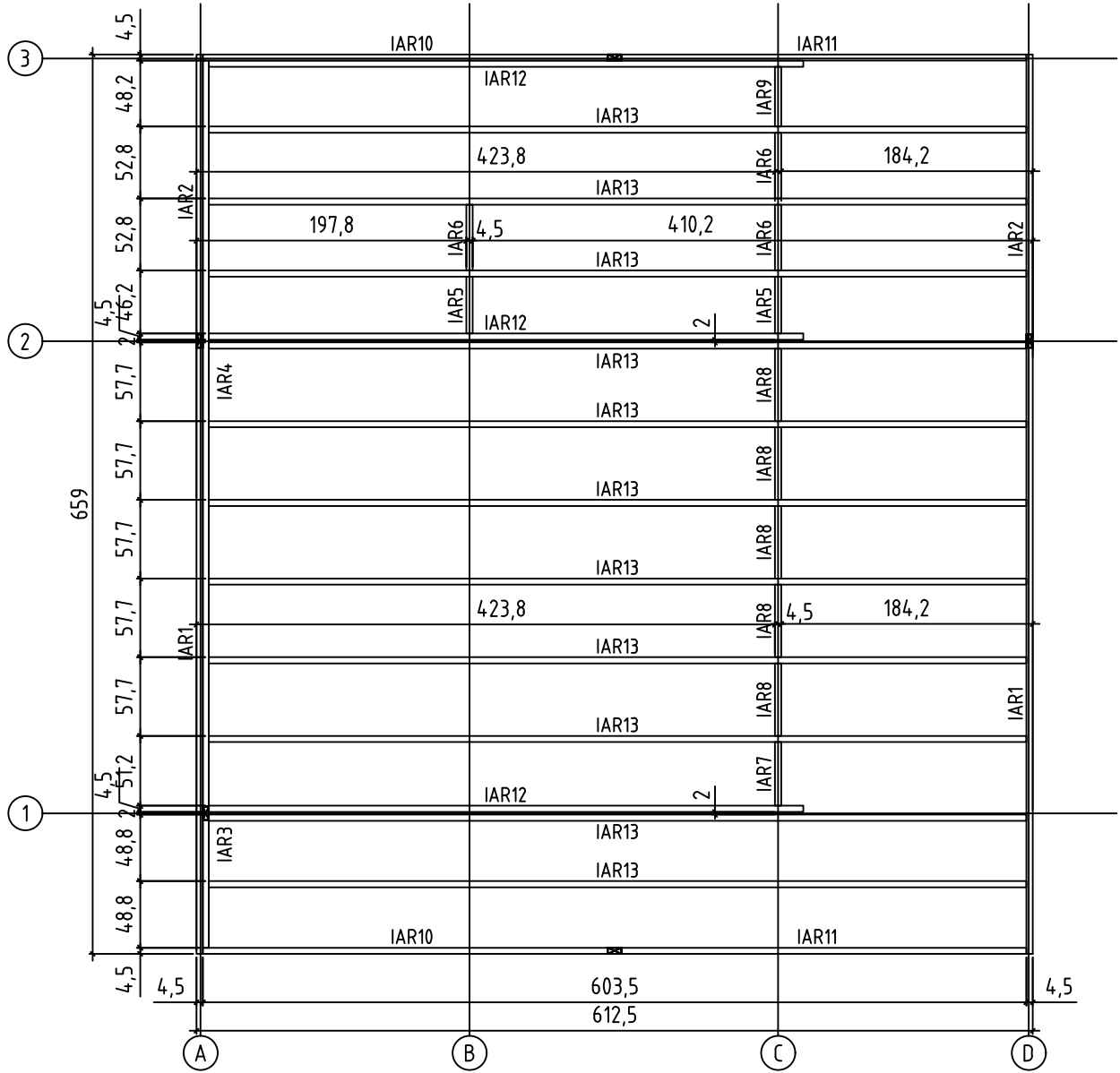

Missouri, Art.No.702541
RAFTERS PLAN - DACHSPARREN - PLAN DE CHEVRON

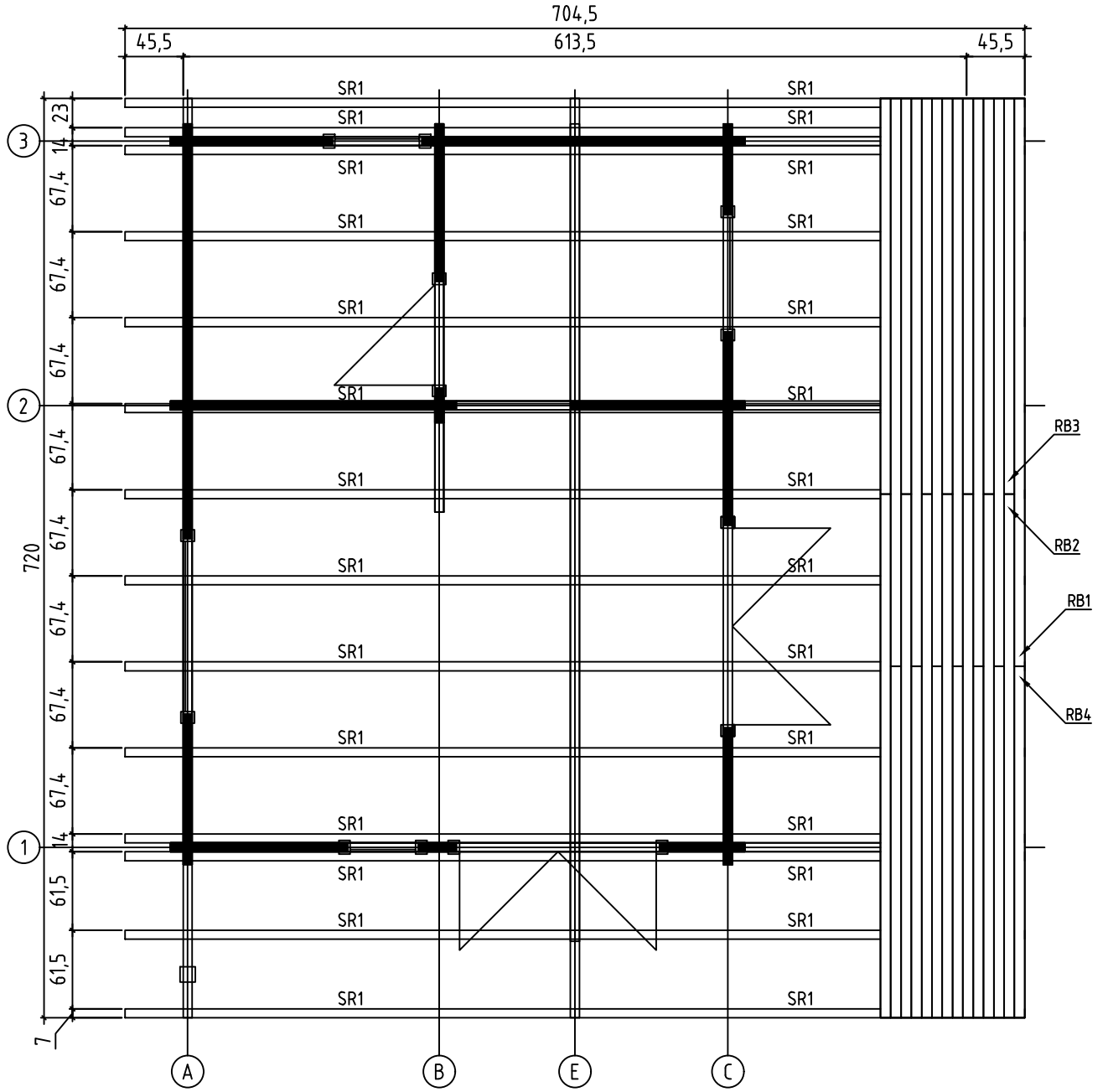

Missouri, Art.No.702541
MEZZANINE FLOOR JOISTS -HALBGESCHOSS BALKEN - SOLIVES DE PLANCHER MEZZANINE

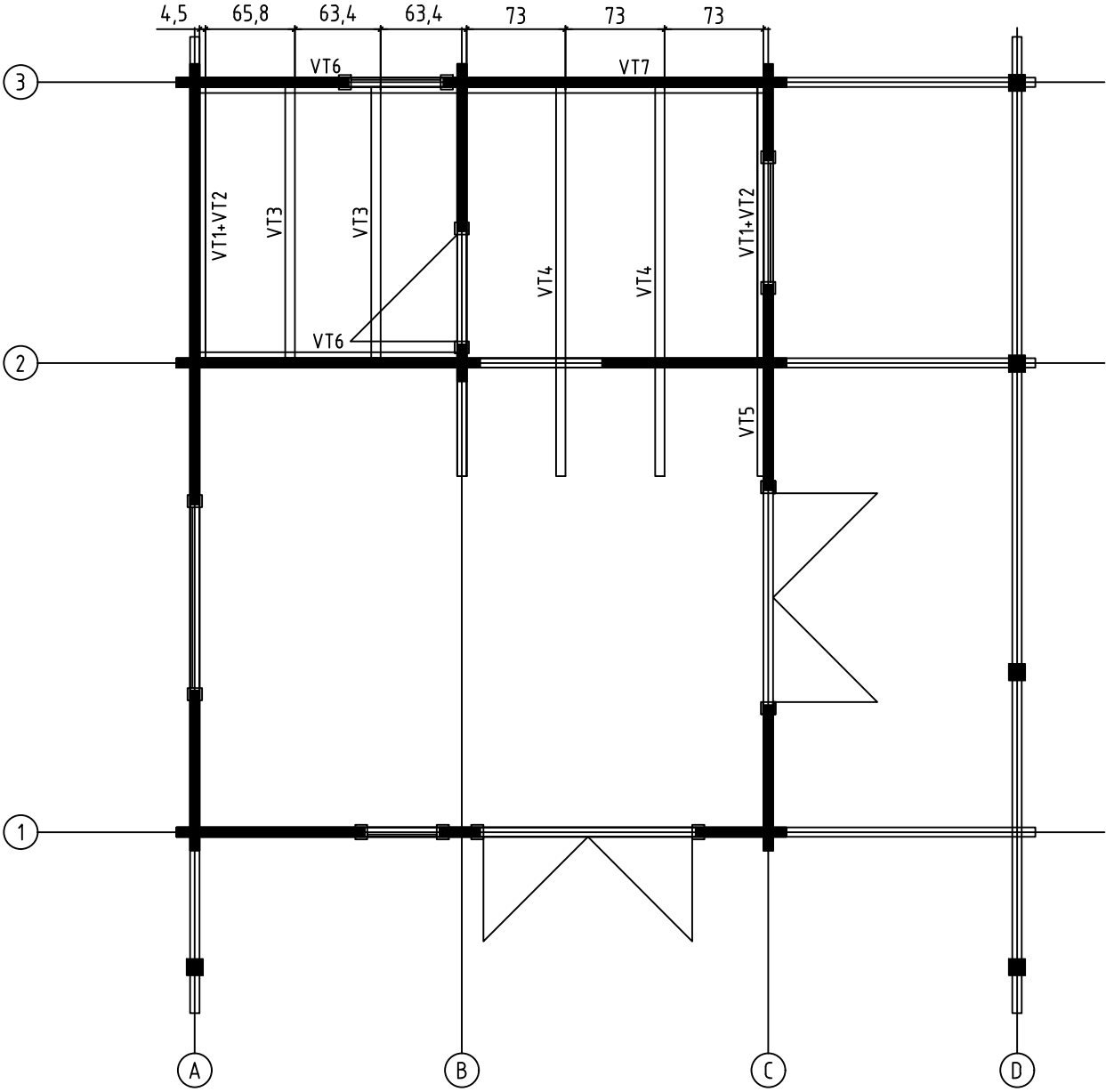

Missouri, Art.No.702541
FLOOR BOARDS - FUSSBODENBRETTER - PLAN POSE PLANCHER

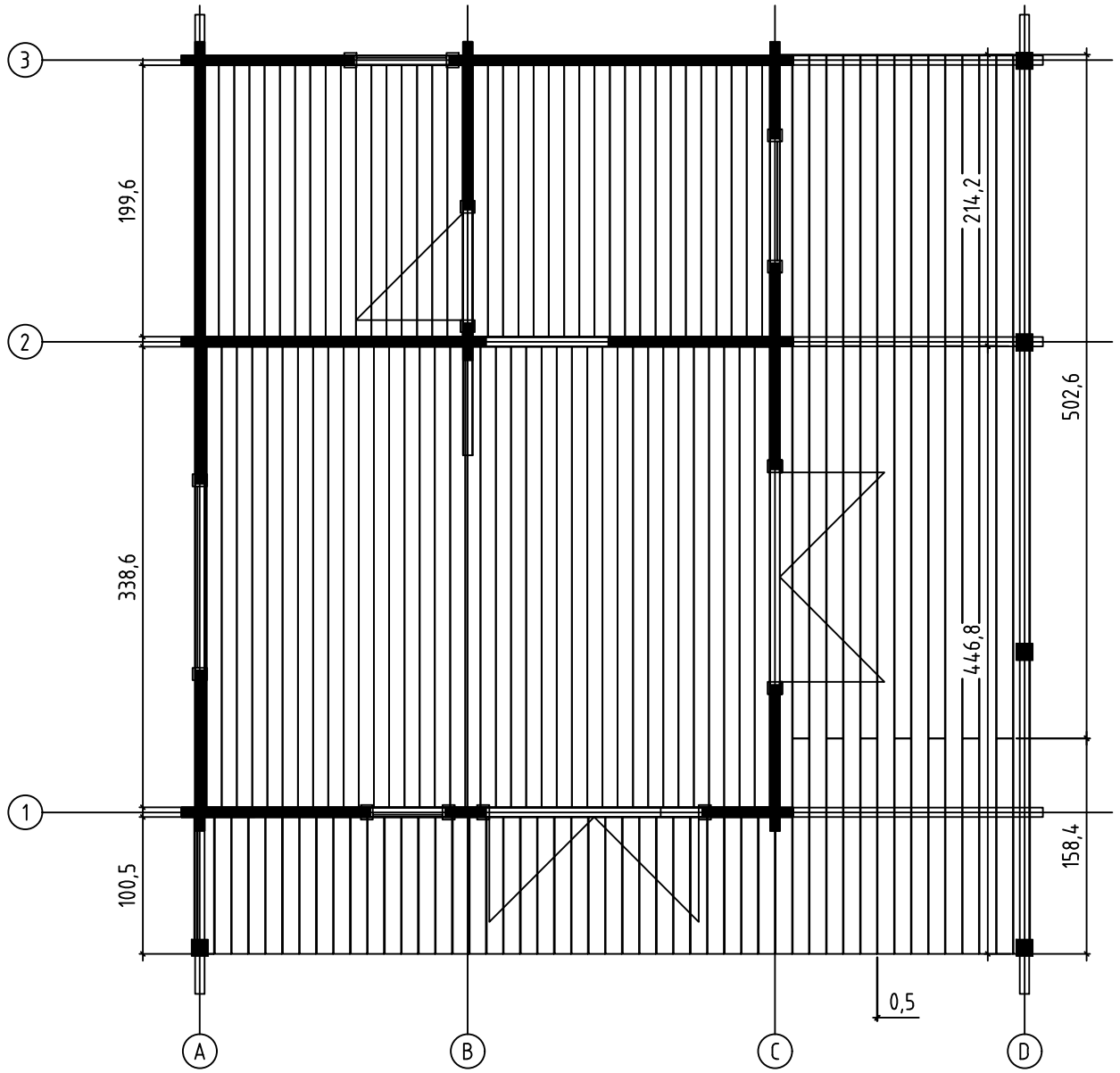

Missouri, Art.No.702541
FLOOR BOARDS MEZZANINE - FUSSBODENBRETTER HALBGESCHOSS - PLAN POSE PLANCHER MEZZANINE

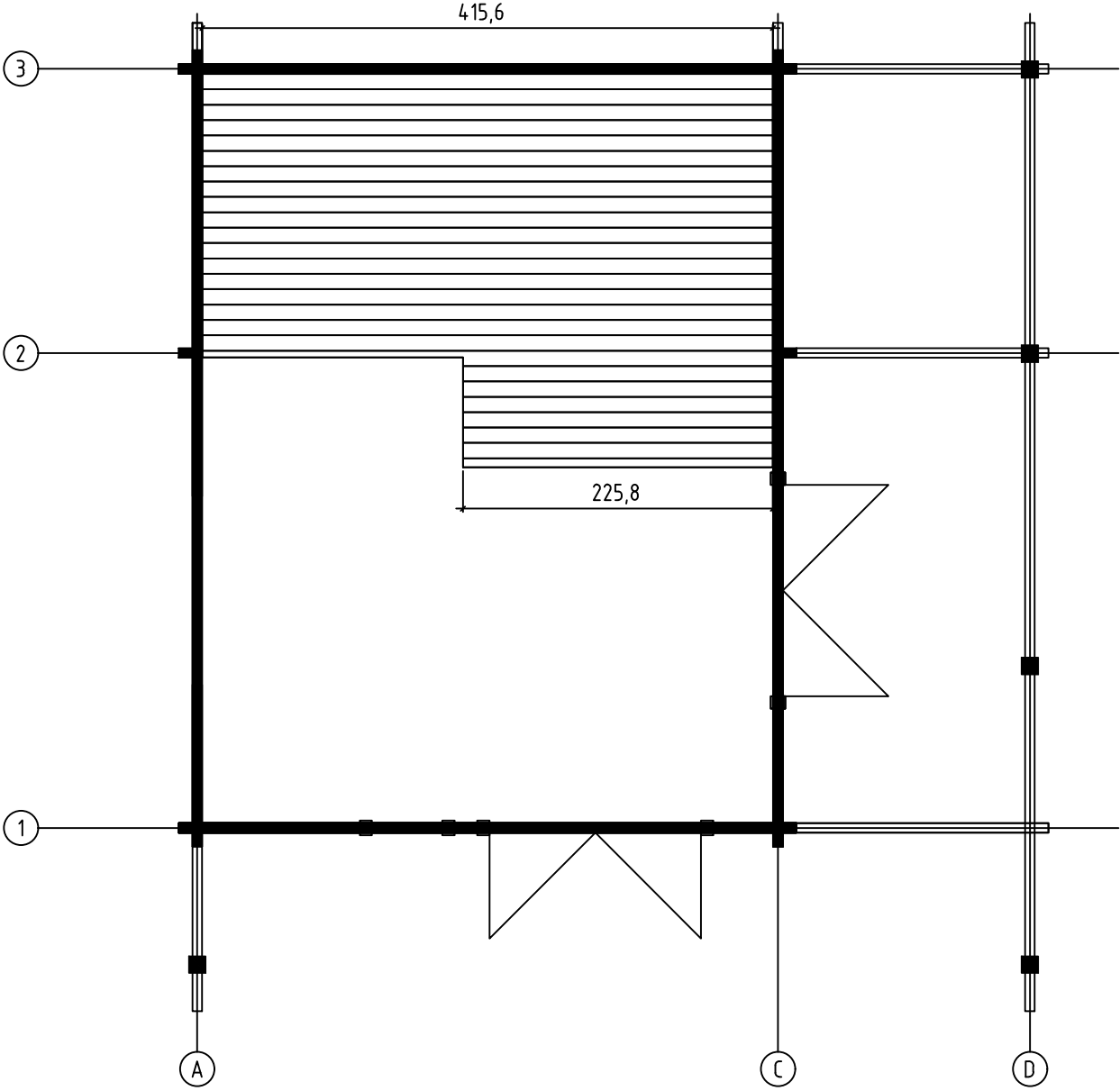

Missouri, Art.No.702541

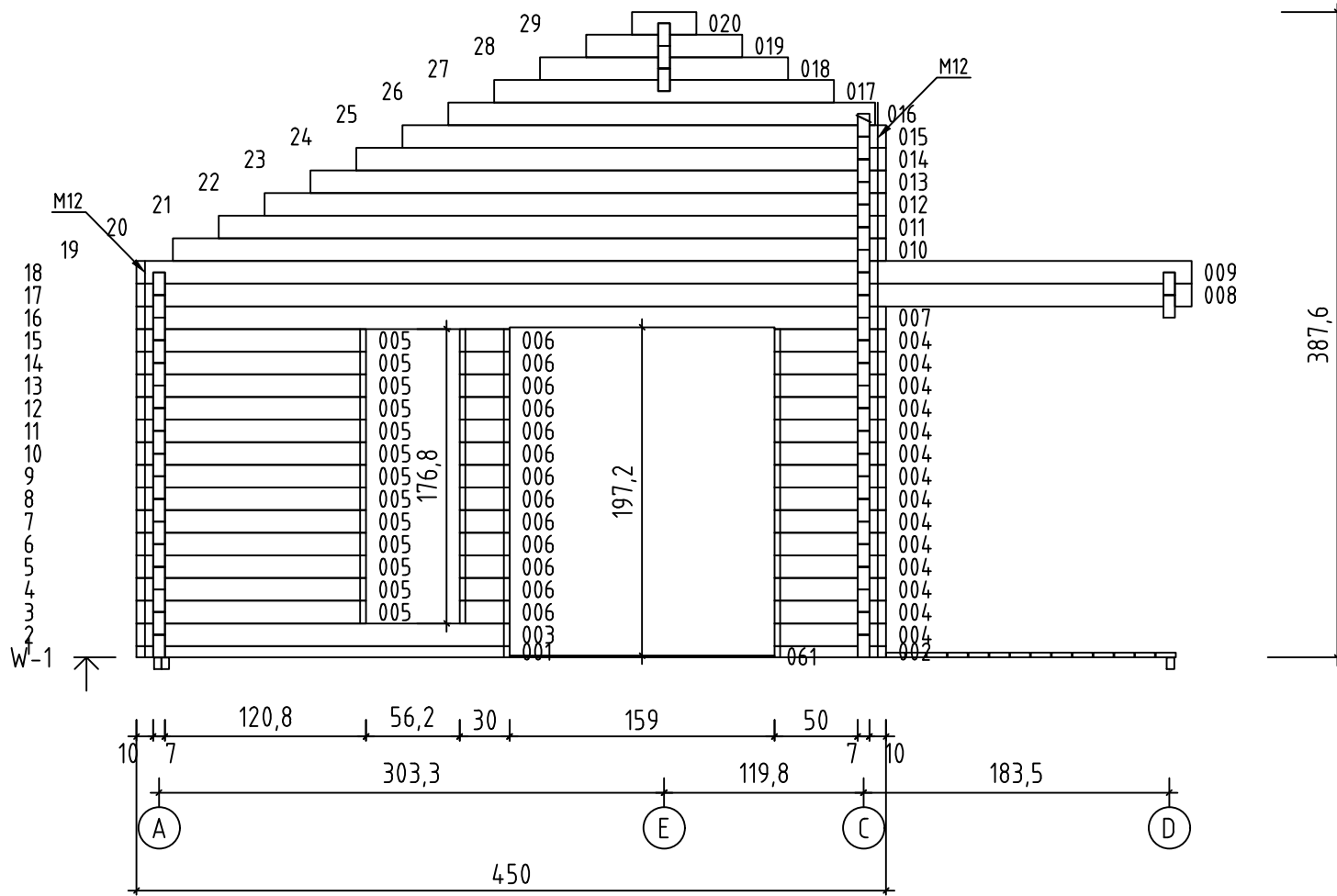

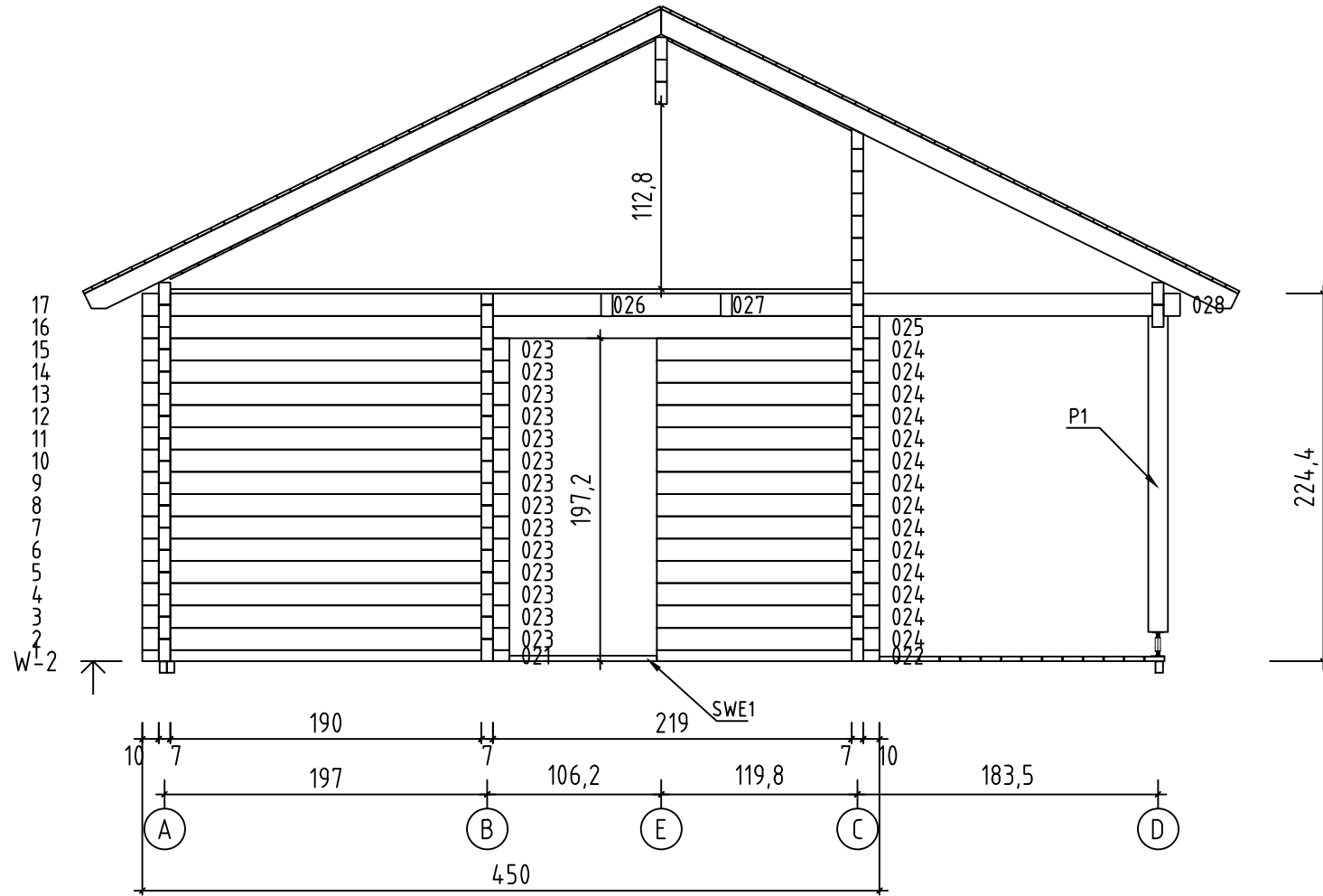

Missouri, Art.No.702541

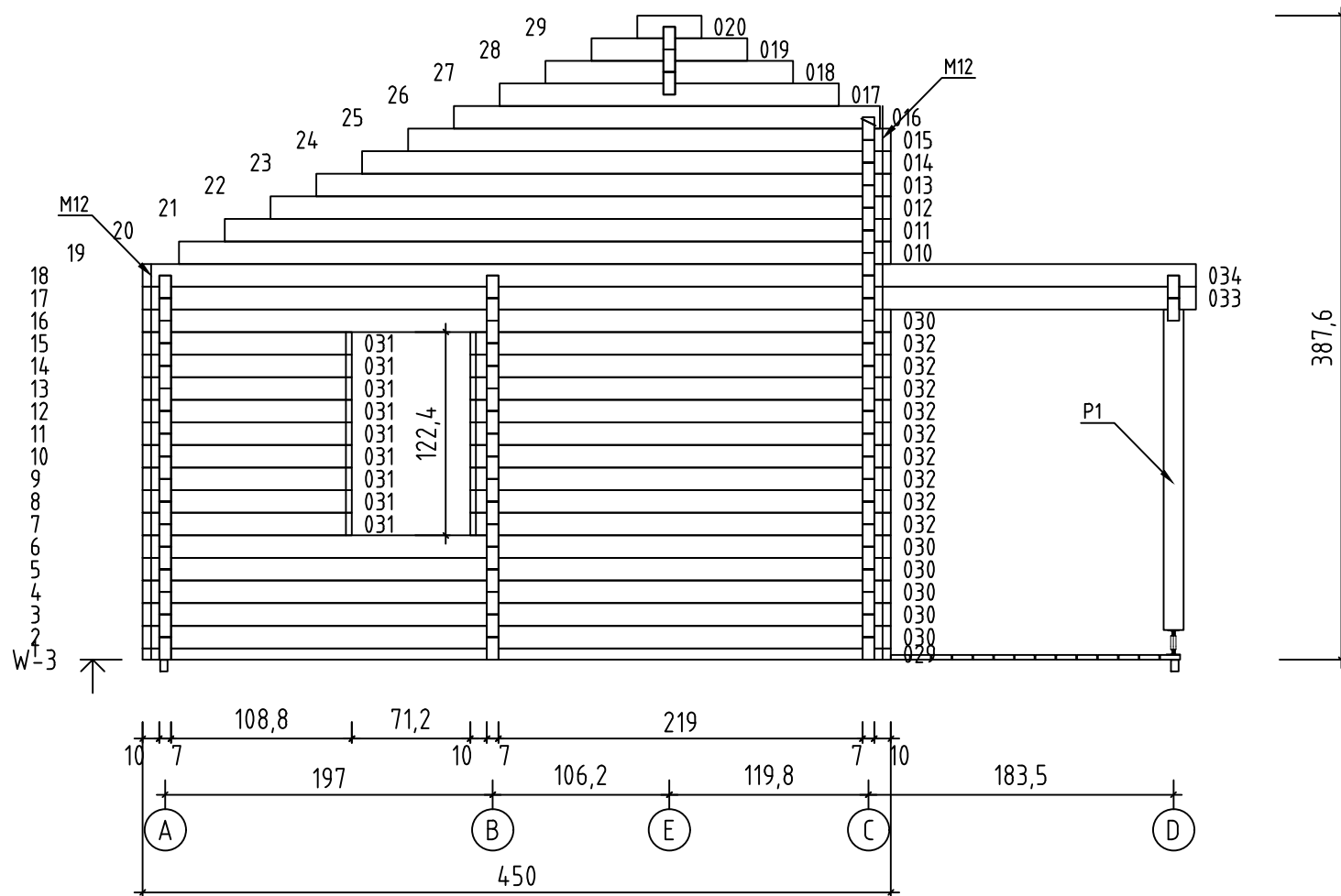

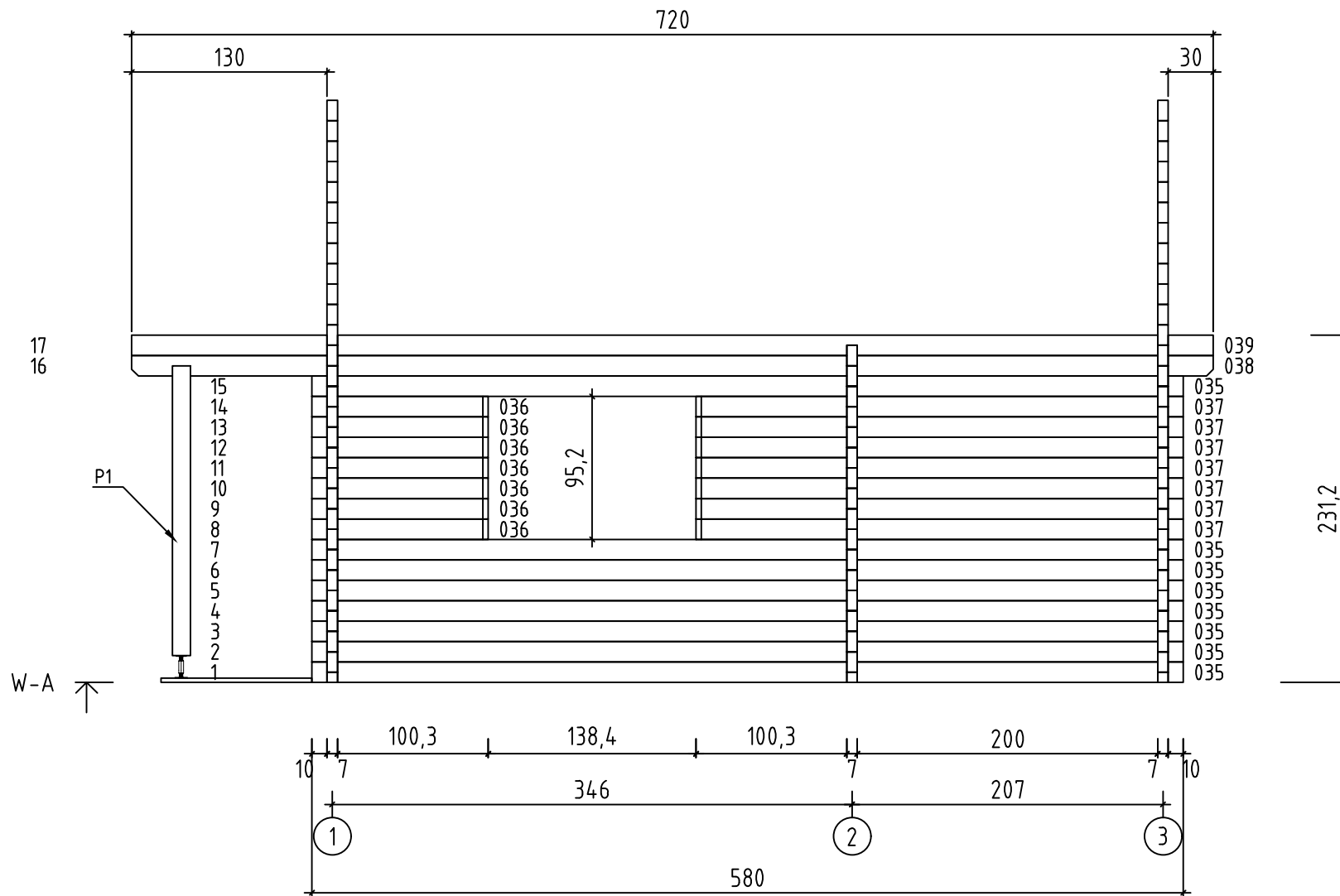

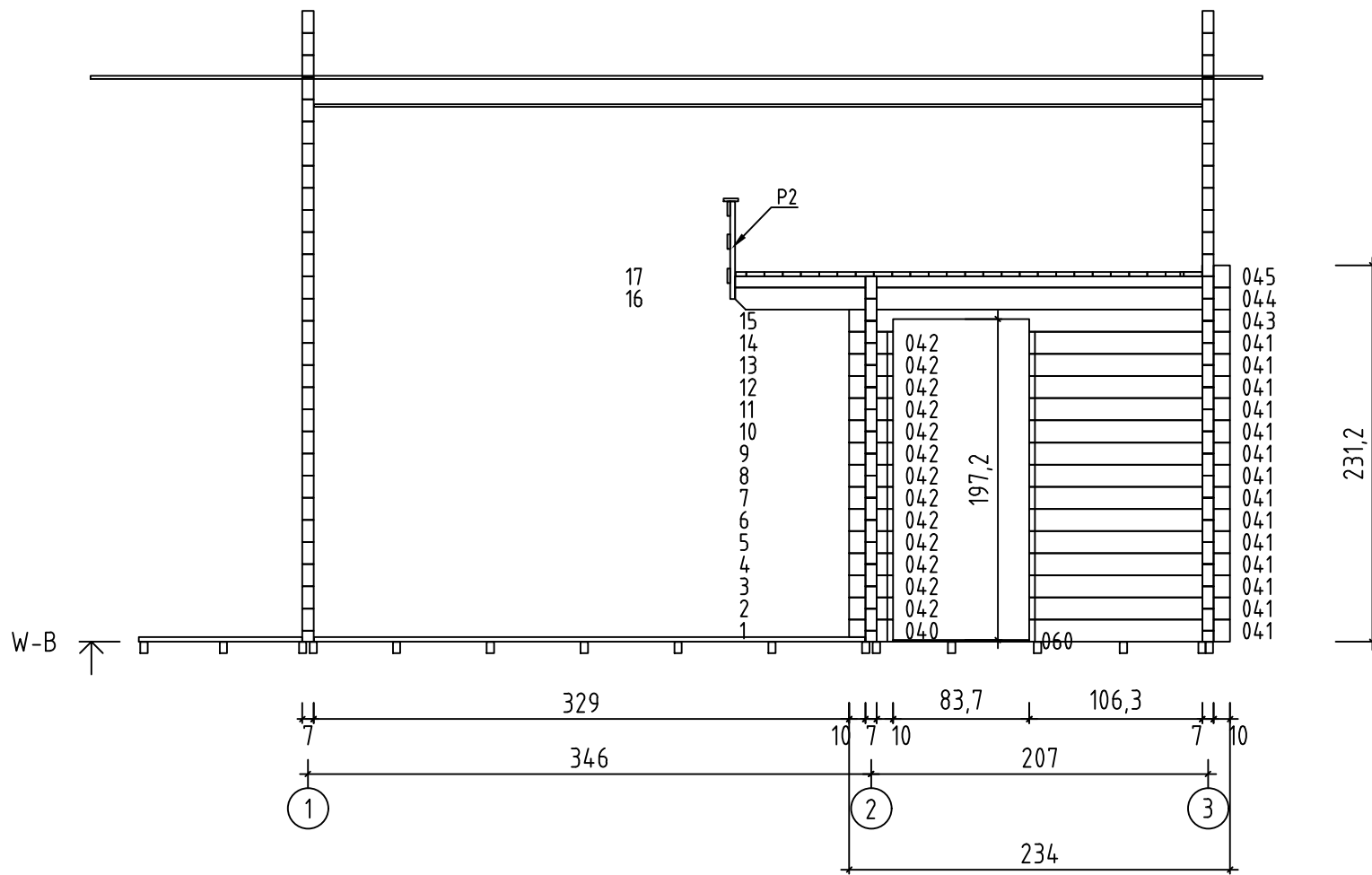

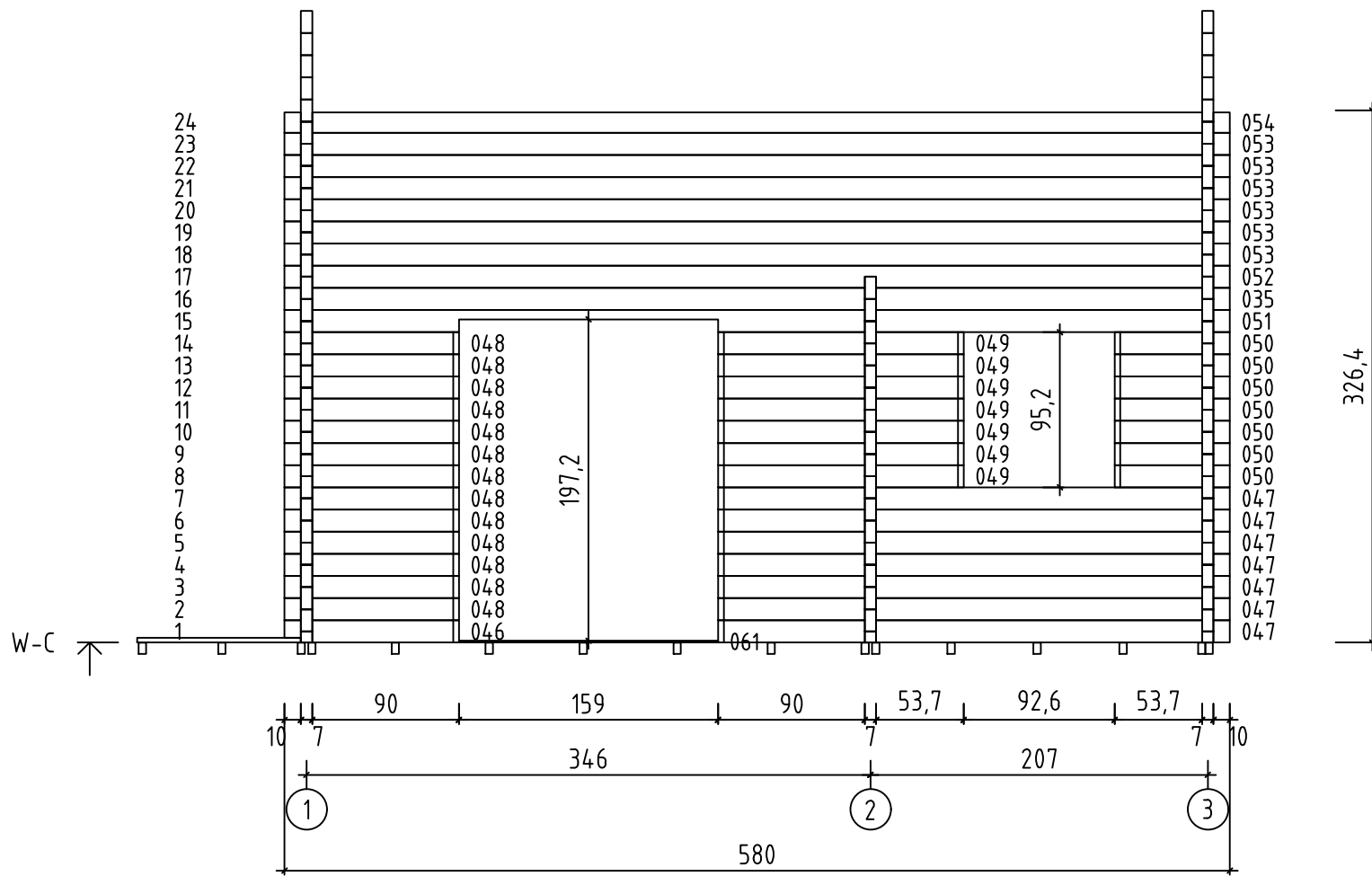

Missouri, Art.No.702541

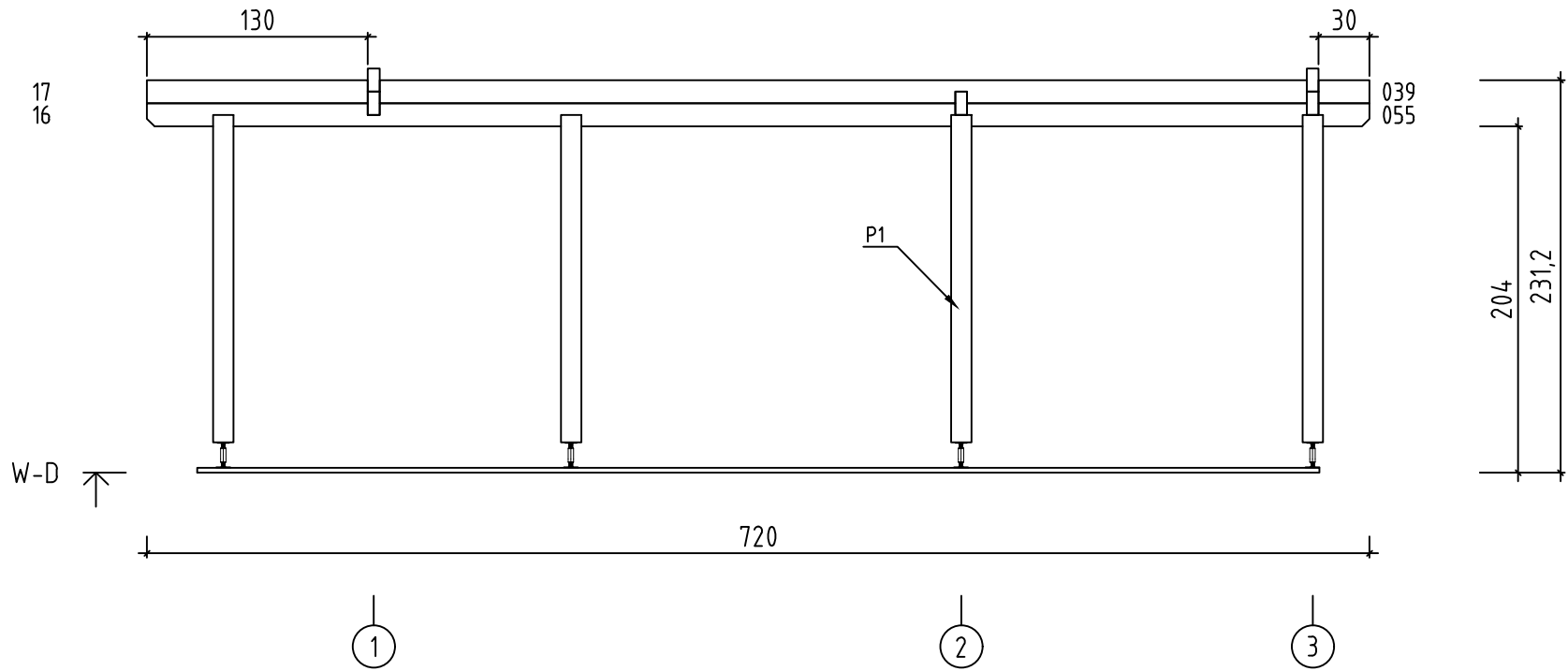



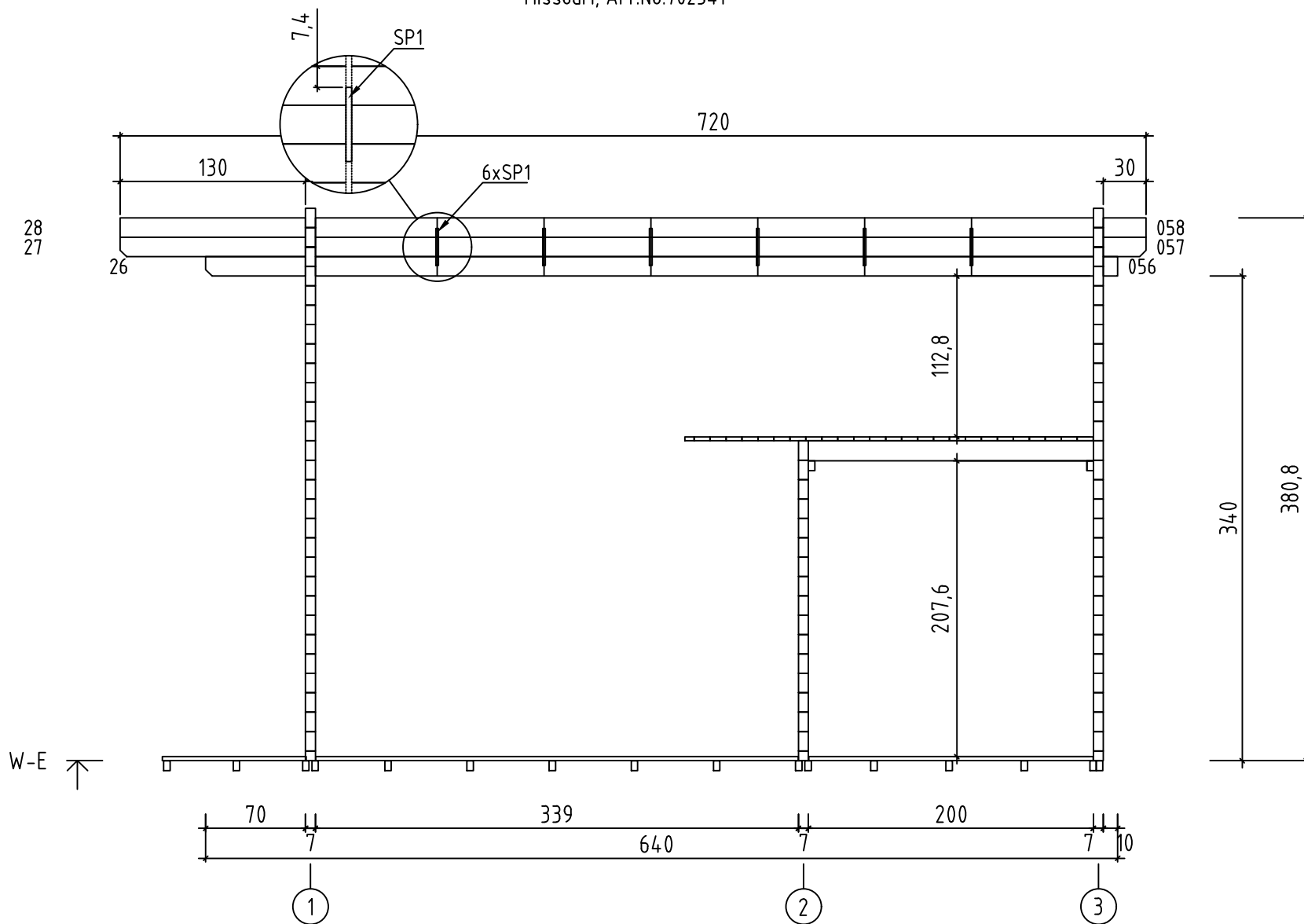



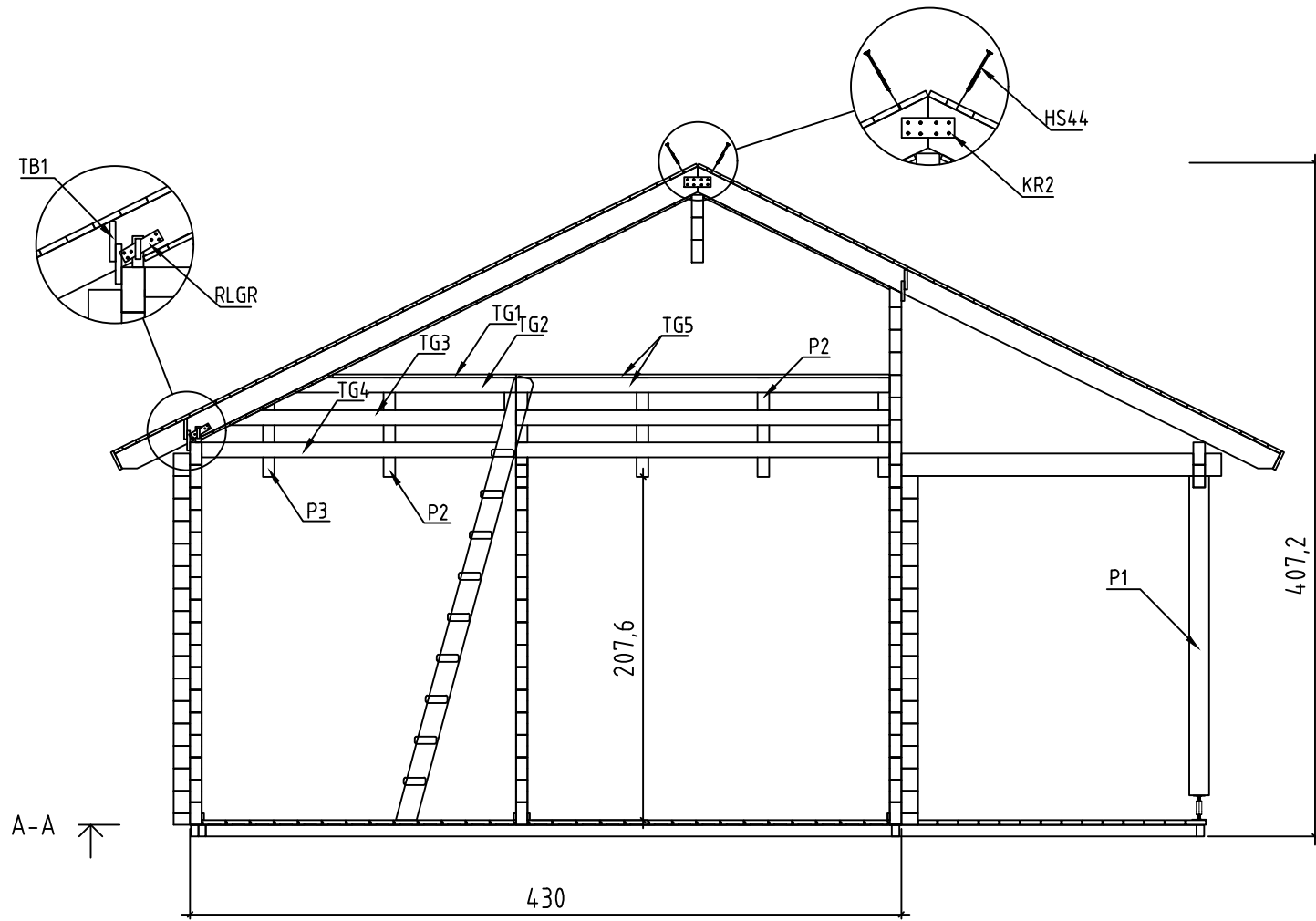

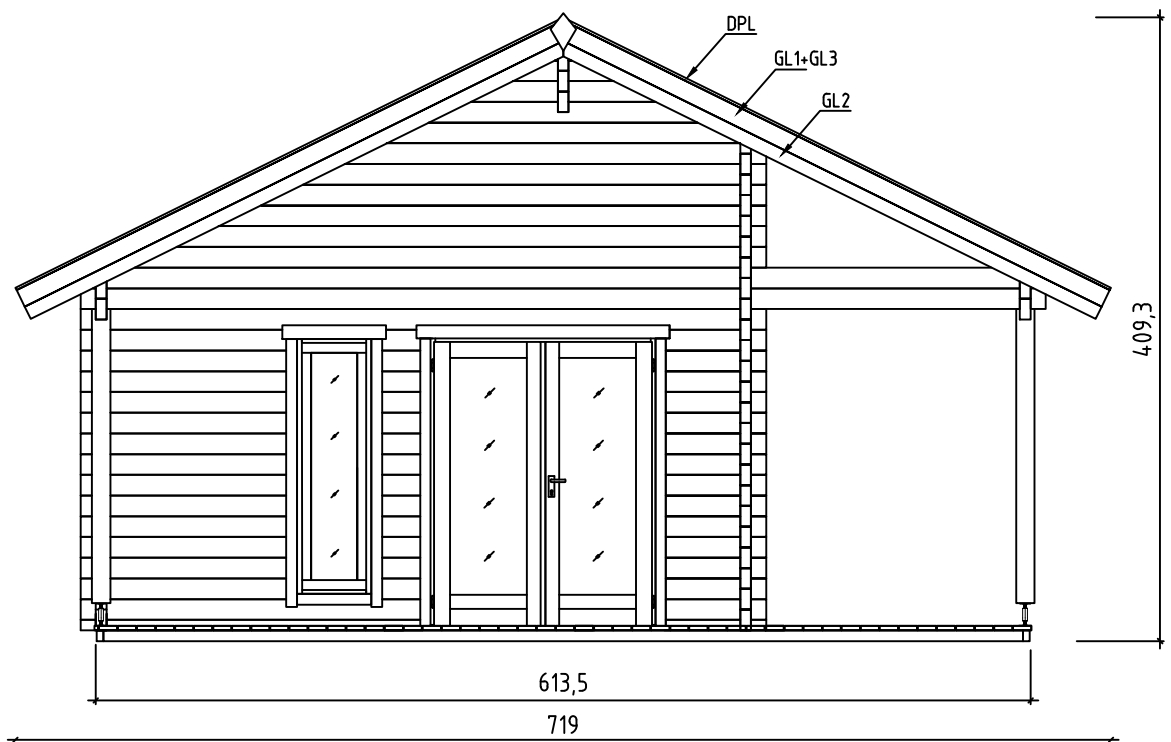
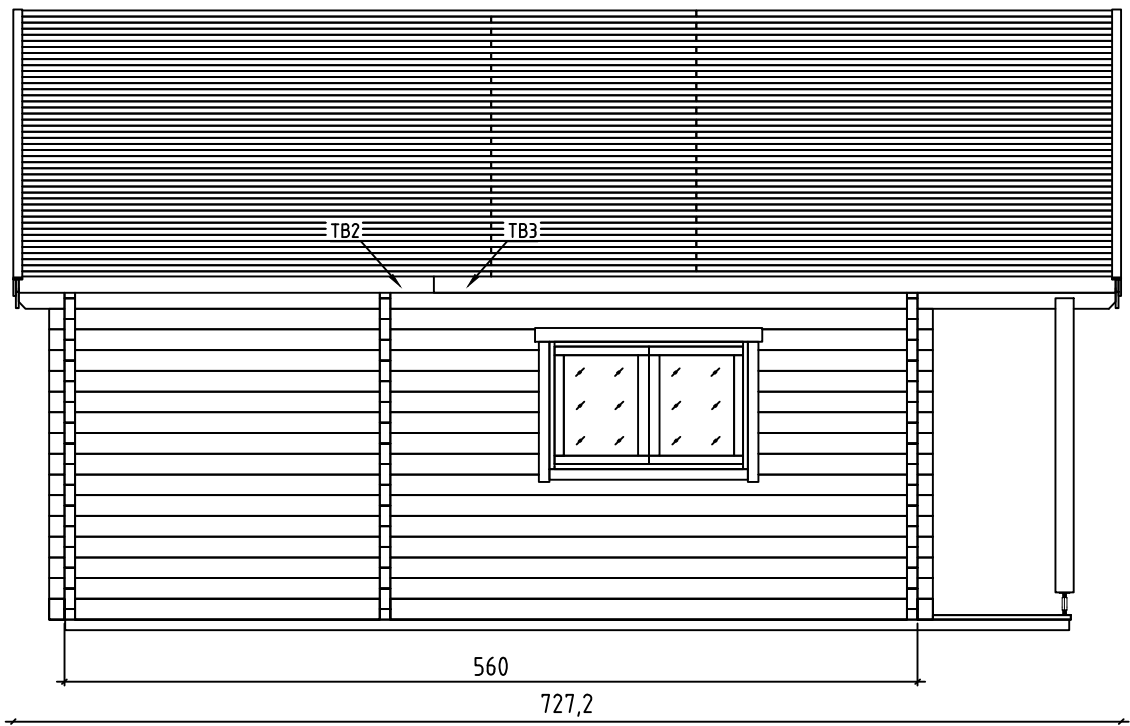

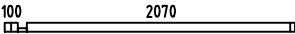

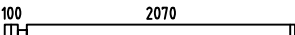

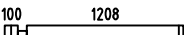
Missouri, Art.No.702541

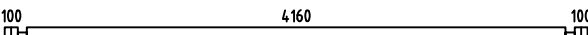
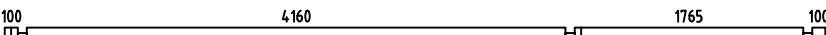
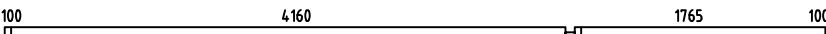
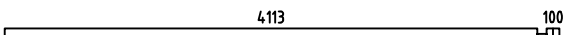
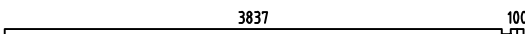
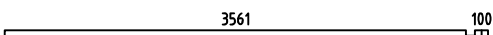
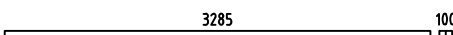
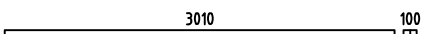
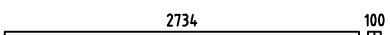
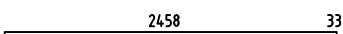





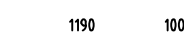



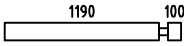
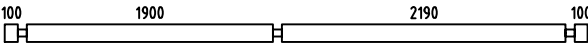
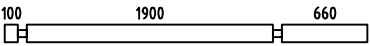

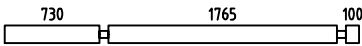
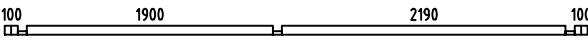
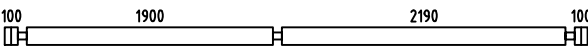
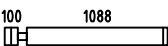
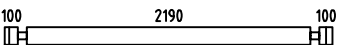
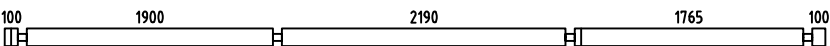
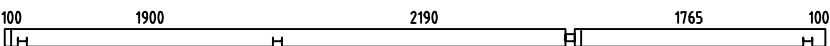
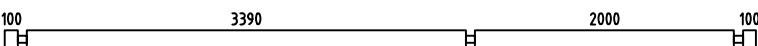
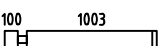
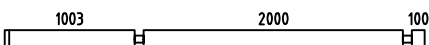
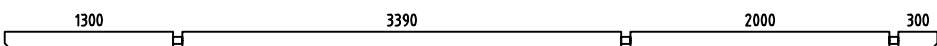
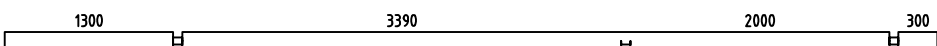

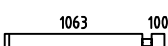

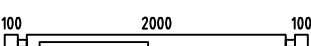
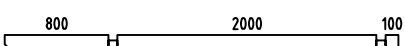
Missouri, Art.No.702541

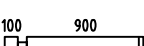

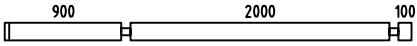
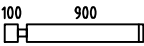
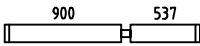

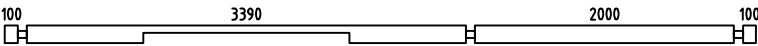
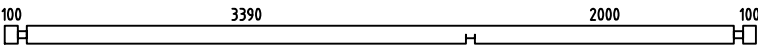
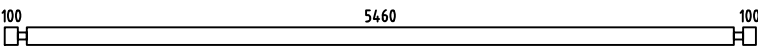
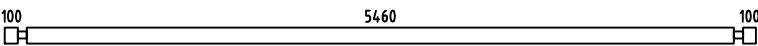
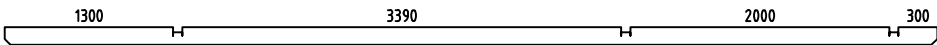
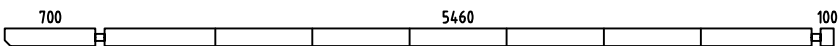
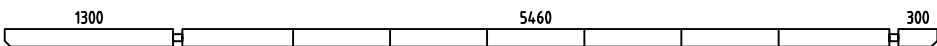
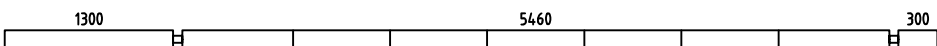
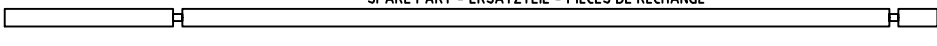

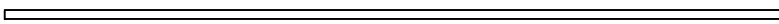
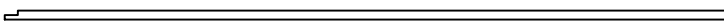
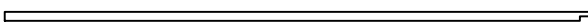
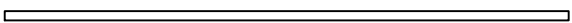
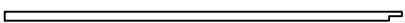
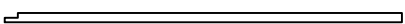





















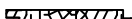
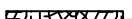
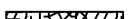











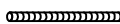
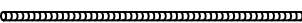
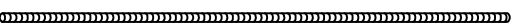



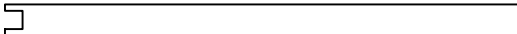
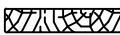
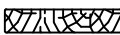
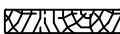
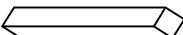







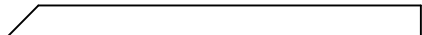
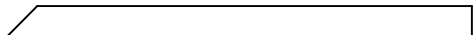

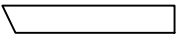

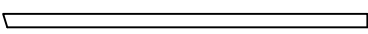
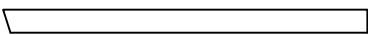
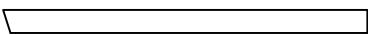



Pos	Missouri, Art.No.702541 Piece list - Stückliste - Liste des pieces	Q.	P (mm)	L (mm)
001		1	70x68	2240
002		1	70x68	670
003		1	70x136	2240
004		14	70x136	670
005		13	70x136	1378
006		13	70x136	300
007		1	70x136	4500
008		1	70x136	6335
009		1	70x136	6335
010		2	70x136	4283
011		2	70x136	4007
012		2	70x136	3731
013		2	70x136	3455
014		2	70x136	3180
015		2	70x136	2904
016		2	70x136	2562
017		2	70x136	2040
018		2	70x136	1489
019		2	70x136	938
020		2	70x136	386
021		1	70x68	2240
022		1	70x68	1360
023		14	70x136	2240

















Pos	Missouri, Art.No.702541 Piece list - Stückliste - Liste des pieces	Q.	P (mm)	L (mm)
024		14	70x136	1360
025		1	70x136	4500
026		1	70x136	2800
027		1	70x136	660
028		1	70x136	2735
029		1	70x68	4500
030		6	70x136	4500
031		9	70x136	1258
032		9	70x136	2530
033		1	70x136	6335
034		1	70x136	6335
035		9	70x136	5800
036		7	70x136	1173
037		7	70x136	3243
038		1	70x136	7200
039		2	70x136	7200
040		1	70x136	270
041		14	70x136	1233
042		13	70x136	270
043		1	70x136	2340
044		1	70x136	3040
045		1	70x136	3040
046		1	70x136	1070

Pos	Missouri, Art.No.702541 Piece list - Stückliste - Liste des pieces	Q.	P (mm)	L (mm)
047		7	70x136	3140
048		13	70x136	1070
049		7	70x136	1507
050		7	70x136	707
051		1	70x136	5800
052		1	70x136	5800
053		6	70x136	5800
054		1	70x124	5800
055		1	70x136	7200
056		1	70x136	6400
057		1	70x136	7200
058		1	70x136	7200
059	SPARE PART - ERSATZTEIL - PIÈCES DE RECHANGE 	1	70x136	7200
060		1	70x10	837
061		2	70x10	1590
IAR13	FOUNDATION - FUNDAMENT - FONDATION 	11	45x70	5990
IAR4	FOUNDATION - FUNDAMENT - FONDATION 	1	45x70	5565
IAR1	FOUNDATION - FUNDAMENT - FONDATION 	2	45x70	4540
IAR12	FOUNDATION - FUNDAMENT - FONDATION 	3	45x70	4355
IAR10	FOUNDATION - FUNDAMENT - FONDATION 	2	45x70	3068
IAR11	FOUNDATION - FUNDAMENT - FONDATION 	2	45x70	3068
IAR2	FOUNDATION - FUNDAMENT - FONDATION 	2	45x70	2150
IAR3	FOUNDATION - FUNDAMENT - FONDATION 	1	45x70	1035

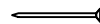
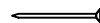

Pos	Missouri, Art.No.702541 Piece list - Stückliste - Liste des pieces	Q.	P (mm)	L (mm)
IAR8	FOUNDATION - FUNDAMENT - FONDATION 	5	45x70	532
IAR6	FOUNDATION - FUNDAMENT - FONDATION 	3	45x70	482
IAR7	FOUNDATION - FUNDAMENT - FONDATION 	1	45x70	467
IAR9	FOUNDATION - FUNDAMENT - FONDATION 	1	45x70	437
IAR5	FOUNDATION - FUNDAMENT - FONDATION 	2	45x70	417
VT4	MEZZANINE FLOOR JOISTS - HALBGESCHOSS BALKEN - SOLIVES DE PLANCHER MEZZANINE 	2	70x140	2870
VT3	MEZZANINE FLOOR JOISTS - HALBGESCHOSS BALKEN - SOLIVES DE PLANCHER MEZZANINE 	2	70x140	2000
VT1	MEZZANINE FLOOR JOISTS - HALBGESCHOSS BALKEN - SOLIVES DE PLANCHER MEZZANINE 	2	45x96	2000
VT5	MEZZANINE FLOOR JOISTS - HALBGESCHOSS BALKEN - SOLIVES DE PLANCHER MEZZANINE 	1	45x96	800
VT7	MEZZANINE FLOOR JOISTS - HALBGESCHOSS BALKEN - SOLIVES DE PLANCHER MEZZANINE 	1	45x70	2190
VT6	MEZZANINE FLOOR JOISTS - HALBGESCHOSS BALKEN - SOLIVES DE PLANCHER MEZZANINE 	2	45x70	1900
VT2	MEZZANINE FLOOR JOISTS - HALBGESCHOSS BALKEN - SOLIVES DE PLANCHER MEZZANINE 	2	45x45	2000
SR1	RAFTER - DACHSPARREN - CHEVRON 	28	70x140	3928
STP	CEILING BOARDS - DECKENBRETTER - VOLIGES SOUS PLAFOND 	42	111x15	5456
PTL	FLOOR BOARDS - FUSSBODENBRETTER - LAME DE PLANCHER 	19	112x28	4156
PTL	FLOOR BOARDS - FUSSBODENBRETTER - LAME DE PLANCHER 	38	112x28	3386
PTL	FLOOR BOARDS - FUSSBODENBRETTER - LAME DE PLANCHER 	7	112x28	2256
PTL	FLOOR BOARDS - FUSSBODENBRETTER - LAME DE PLANCHER 	37	112x28	1996
RB1	ROOF BOARDS - DACHBRETTER - VOLIGES 	44	90x18	4448
RB2	ROOF BOARDS - DACHBRETTER - VOLIGES 	44	90x18	4100
RB3	ROOF BOARDS - DACHBRETTER - VOLIGES 	44	90x18	3100
RB4	ROOF BOARDS - DACHBRETTER - VOLIGES 	44	90x18	2753
SV2	TERRACE BOARDS - TERRASSENBRETTER - PLANCHER DE TERRASSE 	7	120x28	5026

Pos	Missouri, Art.No.702541 Piece list - Stückliste - Liste des pieces	Q.	P (mm)	L (mm)
SV2	TERRACE BOARDS - TERRASSENBRETT - PLANCHER DE TERRASSE 	8	120x28	4468
SV2	TERRACE BOARDS - TERRASSENBRETT - PLANCHER DE TERRASSE 	8	120x28	2142
SV2	TERRACE BOARDS - TERRASSENBRETT - PLANCHER DE TERRASSE 	7	120x28	1584
SV2	TERRACE BOARDS - TERRASSENBRETT - PLANCHER DE TERRASSE 	35	120x28	1005
LL	CEILING FILLET - DECKELEISTE - PROFIL DE FINITION POUR SOUS PLAFOND 		15x40	30.9
	FLOOR FILLET-FUSSBODENLEISTE - CORNIERE DE FINITION DU PLANCHER 		15x40	45.3
DPL	ROOFING FELT FILLET - DACHPAPPENLEISTE - BAGUETTE DE FIXATION DU FEUTRE BITUMEUX 	4	18x58	4000
M12	TREADED ROD M12 - GEWINDESTANGE M12 - TIGE FILETÉE M12 	2		410
M12	TREADED ROD M12 - GEWINDESTANGE M12 - TIGE FILETÉE M12 	2		1226
M12	TREADED ROD M12 - GEWINDESTANGE M12 TIGE FILETÉE M12 	4		2000
LPL	FIXING FILLET - FIXIRUNGSLEISTE - PROFIL DE FIXATION 	1	18x70	791
LPL	FIXING FILLET - FIXIRUNGSLEISTE - PROFIL DE FIXATION 	2	18x70	1933
SWE1	DOORSTEP - SWELLE - SEUIL DE PORTE 	1	28x74	900
P1	POST - PFOSTEN - POTEAU 	5	120x120	1930
TB1	EAVES BOARD - TRAUFBRETT - BANDEAU DE TOIT 	32	18x120	604
TB2	EAVES BOARD - TRAUFBRETT - BANDEAU DE TOIT 	2	18x120	2426
TB3	EAVES BOARD - TRAUFBRETT - BANDEAU DE TOIT 	2	18x120	4774
SP	HIDDEN FIXING - HOLZDÜBEL - TOURILLON BOIS 	6	18x18	260
TBE6	FIXING FILLET FOR WINDOW - FIXIRUNGSLEISTE FÜR FENSTER - PROFIL DE FIXATION DES FENETRES 	4	28x34	919
TBE6	FIXING FILLET FOR WINDOW - FIXIRUNGSLEISTE FÜR FENSTER - PROFIL DE FIXATION DES FENETRES 	2	28x34	1190
TBE6	FIXING FILLET FOR WINDOW - FIXIRUNGSLEISTE FÜR FENSTER - PROFIL DE FIXATION DES FENETRES 	2	28x34	1729
TBE6	FIXING FILLET FOR DOOR - FIXIRUNGSLEISTE FÜR TÜR - PROFIL DE FIXATION DES PORTES 	4	28x34	1825
TBE6	FIXING FILLET FOR DOOR - FIXIRUNGSLEISTE FÜR TÜR - PROFIL DE FIXATION DES PORTES 	2	28x34	1890

Pos	Missouri, Art.No.702541 Piece list - Stückliste - Liste des pieces	Q.	P (mm)	L (mm)
TG1	GUARD-RAIL FOR TERRACE - TERRASSEN- GELÄNDER - MAIN COURANTE DE TERRASSE 	1	18x90	1107
TG2	GUARD-RAIL FOR TERRACE - TERRASSEN- GELÄNDER - MAIN COURANTE DE TERRASSE 	1	18x90	1326
TG3	GUARD-RAIL FOR TERRACE - TERRASSEN- GELÄNDER - MAIN COURANTE DE TERRASSE 	1	18x90	1727
TG4	GUARD-RAIL FOR TERRACE - TERRASSEN- GELÄNDER - MAIN COURANTE DE TERRASSE 	1	18x90	1900
TG5	GUARD-RAIL FOR TERRACE - TERRASSEN- GELÄNDER - MAIN COURANTE DE TERRASSE 	4	18x90	2260
P3	POST - PFOSTEN - POTEAU 	1	45x70	444
P2	POST - PFOSTEN - POTEAU 	6	45x70	600
GL1	GABLE MOULDING - GIBELLEISTE PLANCHE DE RIVE 	4	18x90	4000
GL2	GABLE MOULDING - GIBELLEISTE PLANCHE DE RIVE 	4	18x120	3956
GL3	GABLE MOULDING - GIBELLEISTE PLANCHE DE RIVE 	4	18x120	4000
KL4	LENGTHENING BOLT FOR TREADED ROD - VERLÄNGERUNGSMUTTER FÜR GEWINDESTANGE - MANCHON DE RACCORDEMENT DE TIGE FILETÉE 	4		
KL1	DRIVE NUT TREADED ROD - EINSHLAGMUTTER FÜR GEWINDESTANGE - ÉCROU A FRAPPER POUR TIGE FILITÉE 	4		
KL2	NUT FOR TREADED ROD - MUTTER FÜR GEWINDESTANGE - ÉCROU POUR TIGE FILETÉE 	4		
KL3	PLAIN WASHER TREADED ROD - UNTERLEGSCHIEBE FÜR GEWINDESTANGE - RONDELLE PLATE POUR TIGE FILETÉE 	4		
HS12	SCREW FOR GABLE SEGMENT - SCHRAUBEN FÜR DECKBLATT - VIS POUR FIXATION LOSANGE DE FINITION 	4	3.5x35	
HS83	SCREW FOR FIXING FILLET - SCHRAUBEN FÜR FIXIRUNGSLEISTE - VIS POUR PROFIL DE FIXATION 	13	3.5x50	
HS17	SCREW FOR DOORSTEP - SCHRAUBEN FÜR TÜR SWELLE - VIS POUR SEUIL DE PORTE 	4	3.5x50	
HS84	SCREW FOR FIXING FILLET - SCHRAUBEN FÜR FIXIRUNGSLEISTE - VIS POUR PROFIL DE FIXATION 	64	3.5x50	
HS14	SCREW FOR GUARD-RAIL FOR TERRACE - SCHRAUBEN FÜR TERRASSEN- GELÄNDER - VIS POUR MAIN COURANTE DE TERRASSE 	64	3.5x50	
HS16	SCREW FOR GABLE MOULDING - SCHRAUBEN FÜR GIBELLEISTE - VIS DE FIXATION POUR PLANCHE DE RIVE 	108	3.5x50	
NFD	SCREW FOR ROOFING FELT FILLET - SCHRAUBEN FÜR DACHPAPPENLEISTE - VIS POUR BAGUETTE FIXATION FEUTRE BITUMEUX 	36	4x40	
HS73	SCREW FOR CONNECTING PLATE - SCHRAUBE FÜR ANSCHLUSSPLATTE - VIS DE FIXATION DES PLAQUES DE CONNEXION 	112	4x40	
HS86	SCREW FOR RAFTER SLIDER - SCHRAUBEN FÜR DACHSPARREN SCHIEBEREGLER - VIS DE FIXATION CURSEUR POUR CHEVRON 	225	4x40	

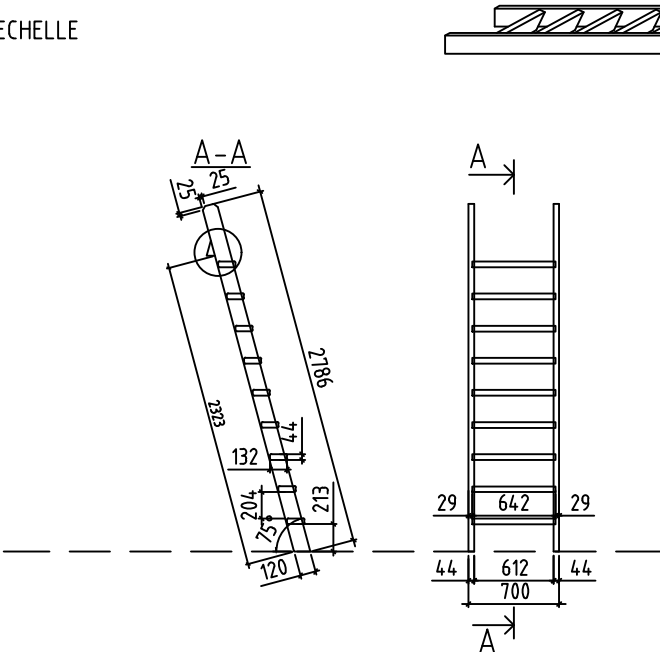
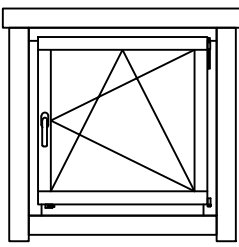
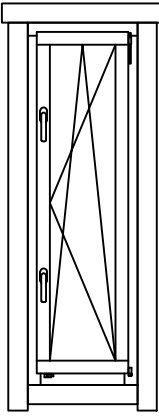
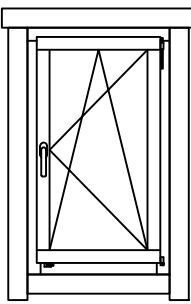
Pos	Missouri, Art.No.702541 Piece list - Stückliste - Liste des pieces	Q.	P (mm)	L (mm)
HS34	SCREW FOR POST - SCHRAUBEN FÜR PFOSTEN - VIS DE FIXATION DES POTEAUX		10	4x60
HS17	SCREW FOR FLOOR BOARDS - SCHRAUBEN FÜR FUSSBODENBRETTER VIS D'ASSEMBLAGE DES LAMES DE PLANCHER		640	4x60
HS36	SCREW FOR STEPLADDER - SCHRAUBE FÜR LEITER - VIS D'ASSEMBLAGE DES MARCHES DE L'ECHELLE		36	4x60
HS86	SCREW FOR MEZZANINE FLOOR JOISTS - SCHRAUBEN FÜR HALBGESCHOSS BALKEN - VIS DE FIXATION SOLIVES DE PLANCHER MEZZANINE		31	5x100
HS40	SCREW FOR 1. WALL BEAM - SCHRAUBE FÜR 1. BOHLENREIHE - VIS DE FIXATION DES FONDATIONS		17	5x120
HS39	SCREW FOR FUNDAMENT - SCHRAUBEN ZUR BEFESTIGUNG FUNDAMENT - VIS POUR FONDATION		80	5x90
HS41	SCREW FOR POST (P2) - SCHRAUBEN FÜR PFOSTEN (P2) VIS DE FIXATION DES POTEAUX (P2)		14	5x90
HS44	SCREW FOR RAFTER - SCHRAUBEN ZUR BEFESTIGUNG DACHSPARREN - VIS POUR CHEVRON		28	6x180
HS49	SCREW FOR POST HEIGHT ADJUSTMENT - SCHRAUBEN FÜR REGULIERUNGSSCHRAUBE FÜR PFOSTEN - VIS DE FIXATION DE SUPPORT RÉGLABLE DE POTEAU		40	6x50
MS	SCREW FOR DOORSTEP - SCHRAUBEN FÜR TÜRSCHWELLE - VIS DE FIXATION DU SEUIL DE PORTE		8	4.5x65
NF3	SCREW FOR TERRACE BOARD - SCHRAUBE FÜR TERRASSENBRETT VIS POUR PLANCHER DE TERRASSE		630	4.2x55
SH70	HAMMER BLOCK - SCHLAGHOLZ - CALLE DE FRAPPE		2	
NFF	ZN NAIL FOR FILLETS - ZN NÄGEL FÜR LEISTEN - POINTE POUR CORNIERE		152	1.4x40
NF2	ZN NAIL FOR ROOF - ZN NÄGEL FÜR DACHBRETTER - POINTE POUR TOIT		1350	2x50
NF2	ZN NAIL FOR CEILING BOARDS - ZN NÄGEL FÜR DECKENBRETTER - CLOUS POUR VOLIGES SOUS PLAFONDS		400	2x50
KR2	CONNECTING PLATE - ANSCHLUSSPLATTE - PLAQUE MÉTALLIQUE DE CONNEXION		14	
ORZ	MONTAGE SET FOR DOORS AND WINDOWS - MONTAGE-SET FÜR TÜREN UND FENSTER - JEU DE MONTAGE PORTES ET FENETRES		1	
GS	GABLE SEGMENT-DECKBLATT - LOSANGE DE FINITION		2	
RLGR	SLIDER FOR RAFTER - SCHIEBEREGLER FÜR DACHSPARREN - SABOT MÉTALLIQUE POUR FIXATION CHEVRON		28	
RFP	POST HEIGHT ADJUSTMENT - REGULIERUNGSSCHRAUBE FÜR PFOSTEN - SUPPORT RÉGLABLE DE POTEAU		5	

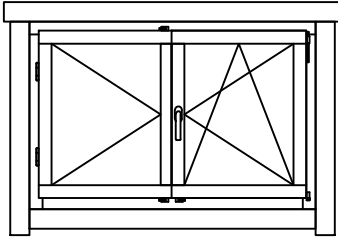
Pos	Missouri, Art.No.702541 Piece list - Stückliste - Liste des pieces	Q.	P (mm)	L (mm)
LR	LADDER - LEITER - ECHELLE 	1		
2+ A.OP.K	WINDOW-FENSTER-FENETRE 916x916 	1		
2+ A.OP.bK	WINDOW-FENSTER-FENETRE 552x1729 	1		
2+ A.OP.dK	WINDOW-FENSTER-FENETRE 702x1190 	1		

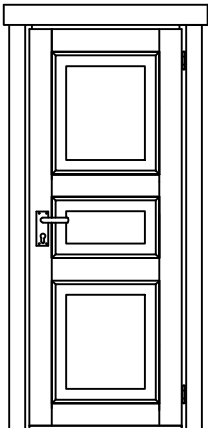
Pos	Missouri, Art.No.702541 Piece list - Stückliste - Liste des pieces	Q.	P (mm)	L (mm)
2+ TA.0P.K	WINDOW-FENSTER-FENETRE 1374x916 	1		
2+ TU.10P.K	DOOR-TÜR-PORTE 1580x1933 	1		
2+ TU.10V.K	DOOR-TÜR-PORTE 1580x1933 	1		
U.3TP	DOOR-TÜR-PORTE 827x1933 +LPL 	1		

