

Malmö
Art.No. 7015041

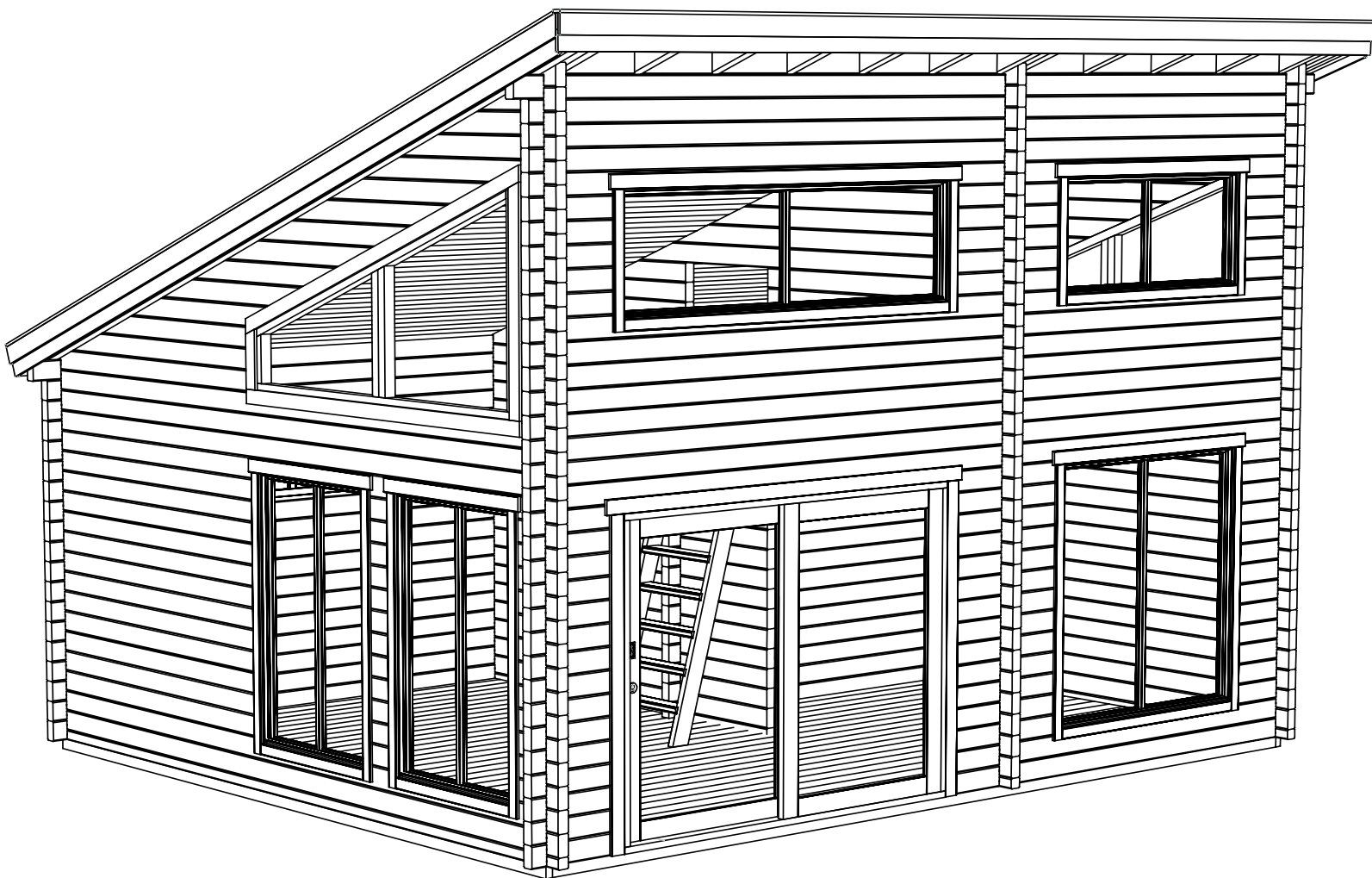

Grundplan - Grundplan - Plan de masse - Planimetria - Plattegrond -
Põhiplaan

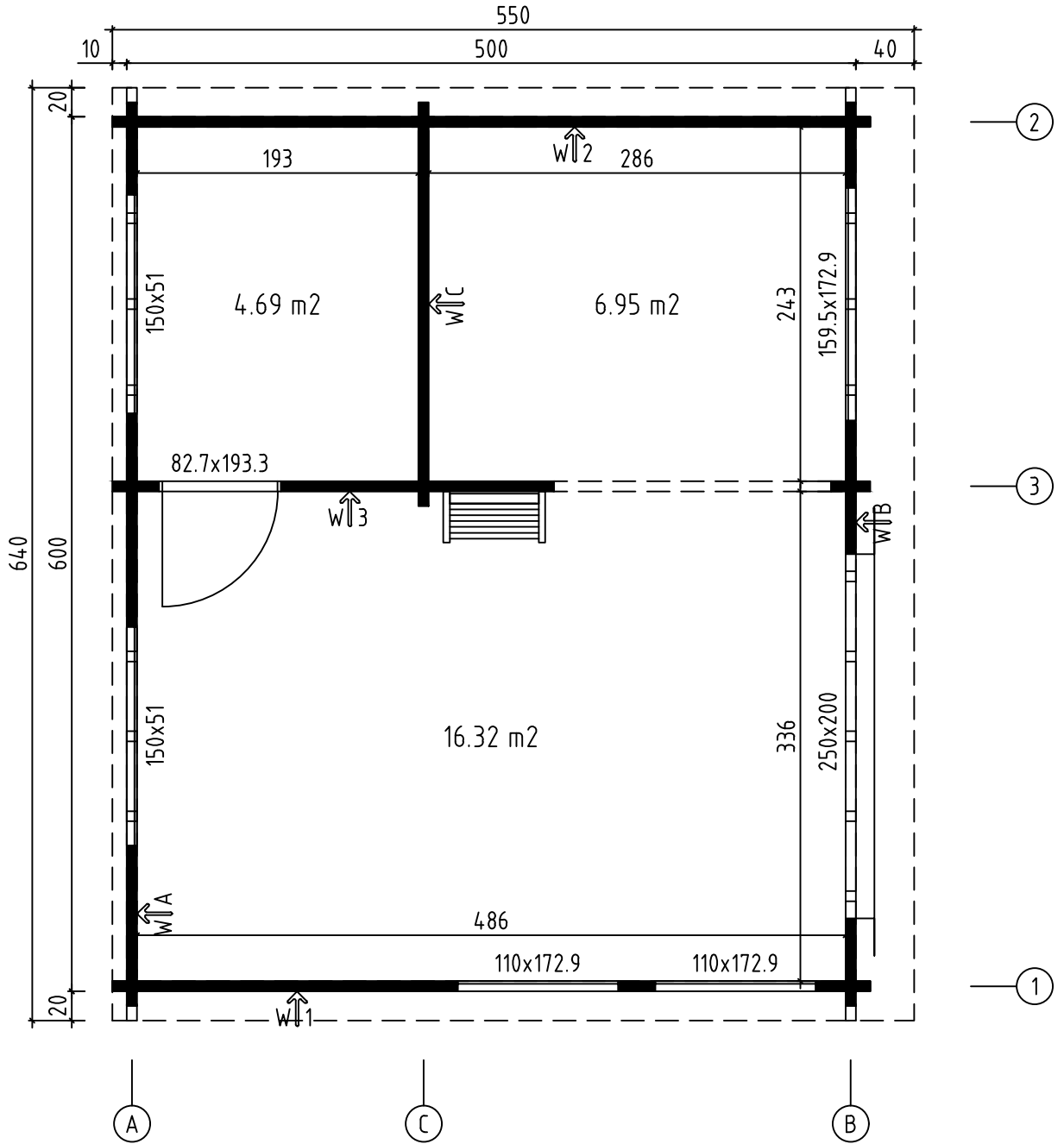

Malmö, Art.No.7015041

Grundplan - Grundplan - Plan de masse - Planimetria - Plattegrond -
Põhiplaan

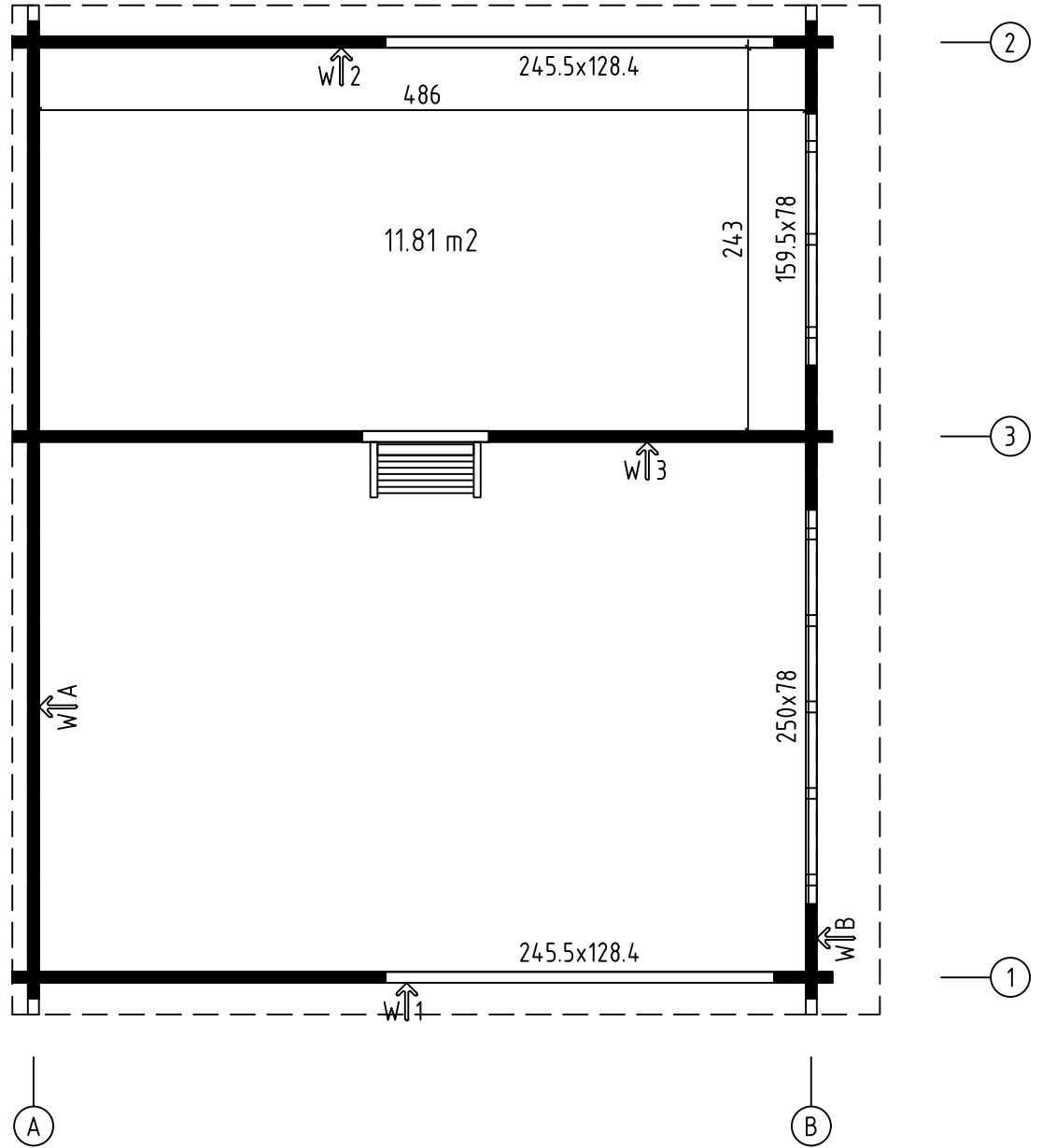

Foundation - Fundament - Fondation - Fondamenta - Fundering - Immutatud alusraam

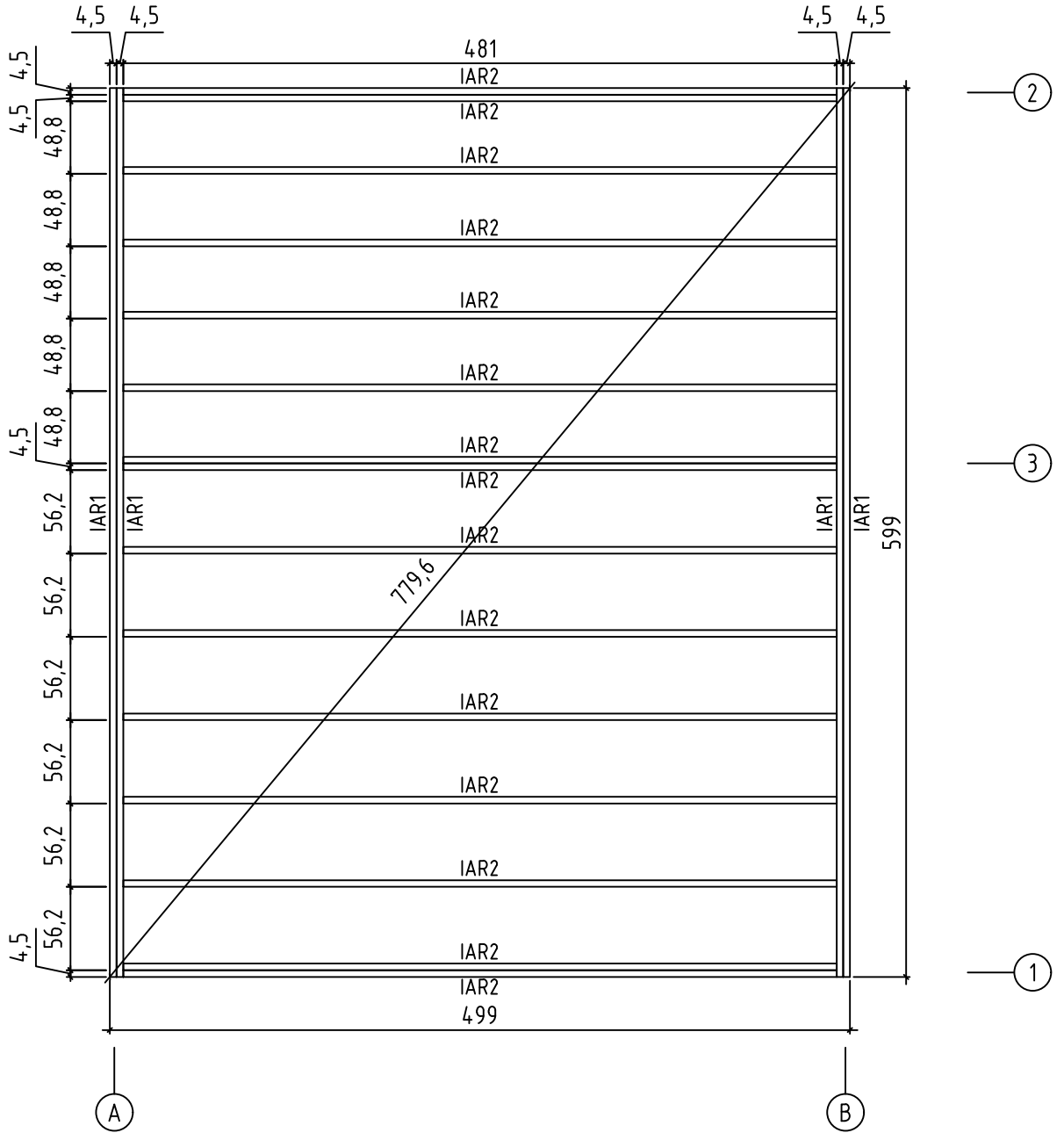

Rafters plan - Dachsparren - Plan de chevron - Piano di travi - Dak spar
constructie plattegrond - Sarikaplaan

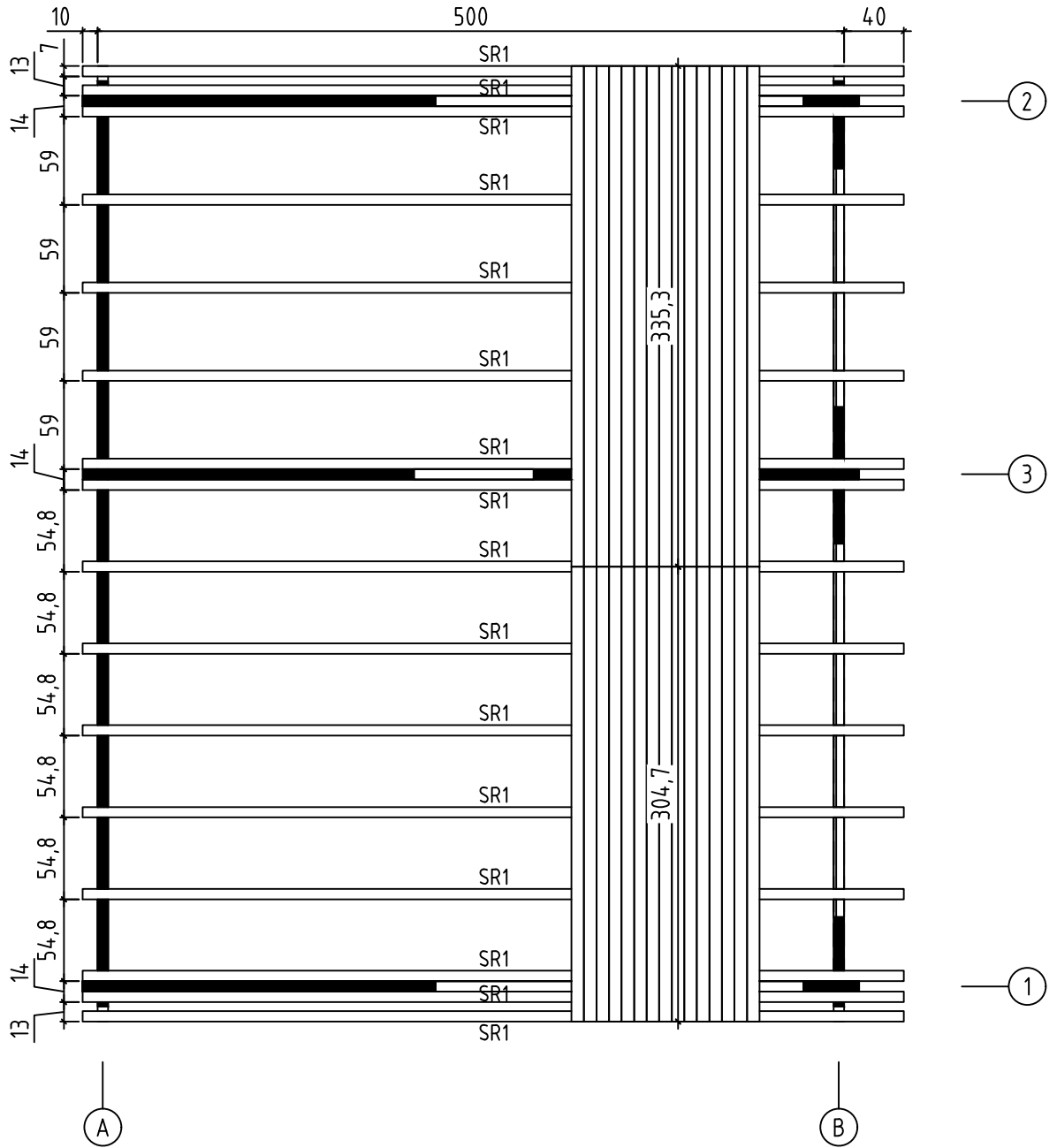

Mezzanine floor joists - Halbgeschoss balken - Solives de plancher mezzanine
- Travi del pavimento mezzanino - Plaatduim scharnier - Vahelaetalad

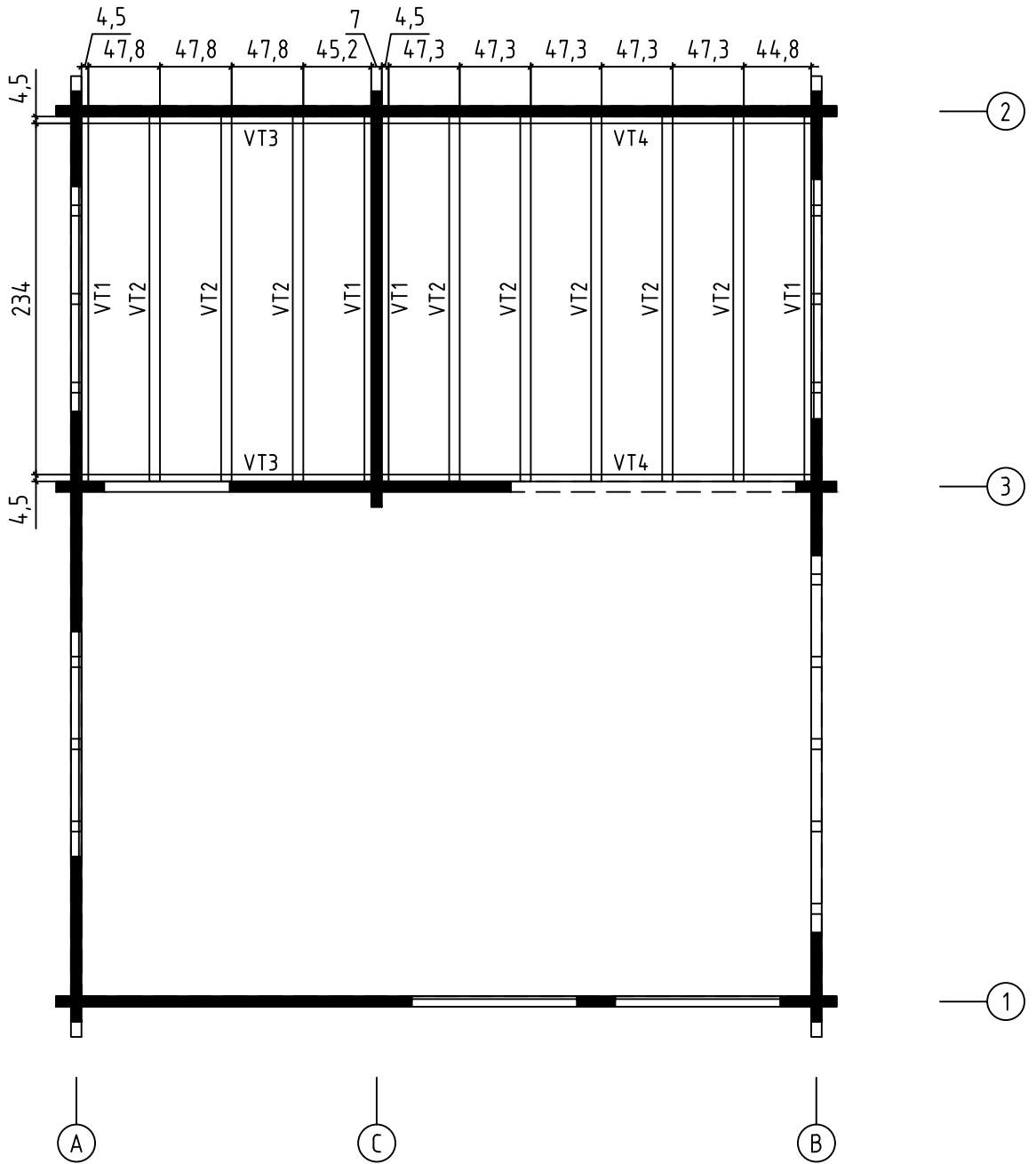

Malmö, Art.No.7015041

Floor boards - Fussbodenbretter - Plan pose plancher - Pavimento - Vloerhout
- Põrandalaudis

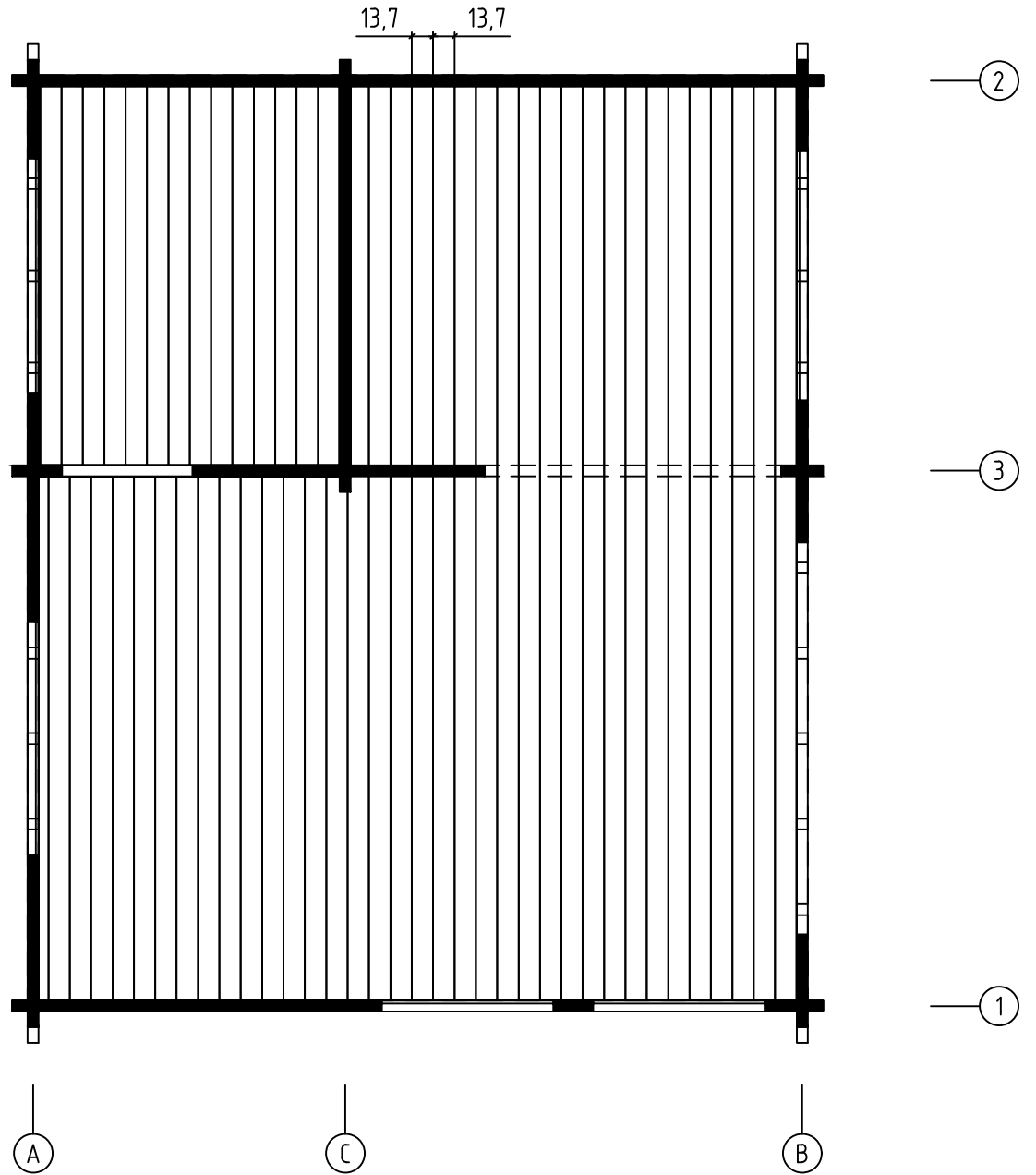

Malmö, Art.No.7015041

Floor boards - Fussbodenbretter - Plan pose plancher - Pavimento - Vloerhout
- Põrandalaudis

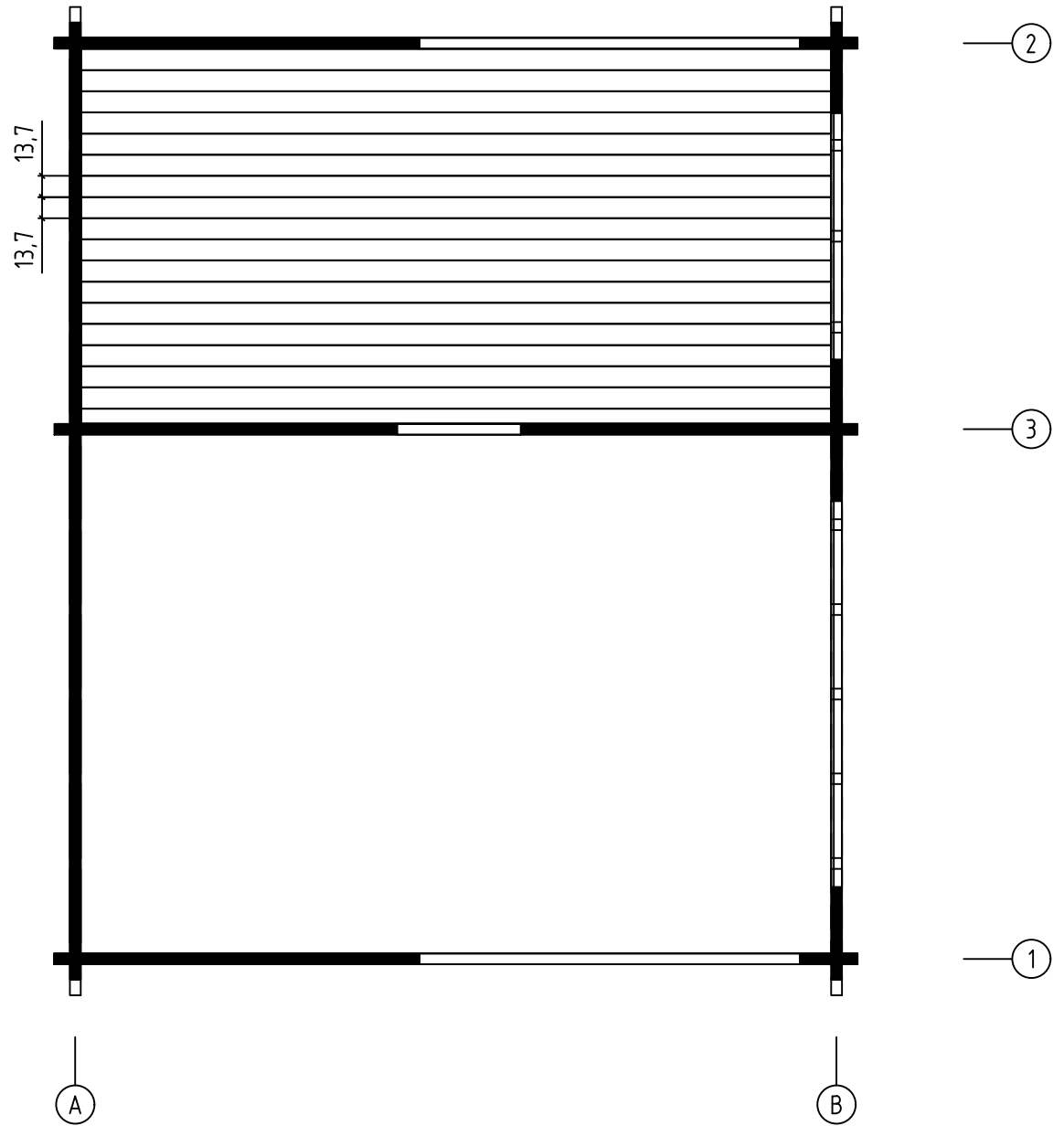

Malmö, Art.No.7015041

Ceiling boards - Deckenbrett - Voliges sous plafond - Tavole per piano soffitto
- Dakhout - Laelaud

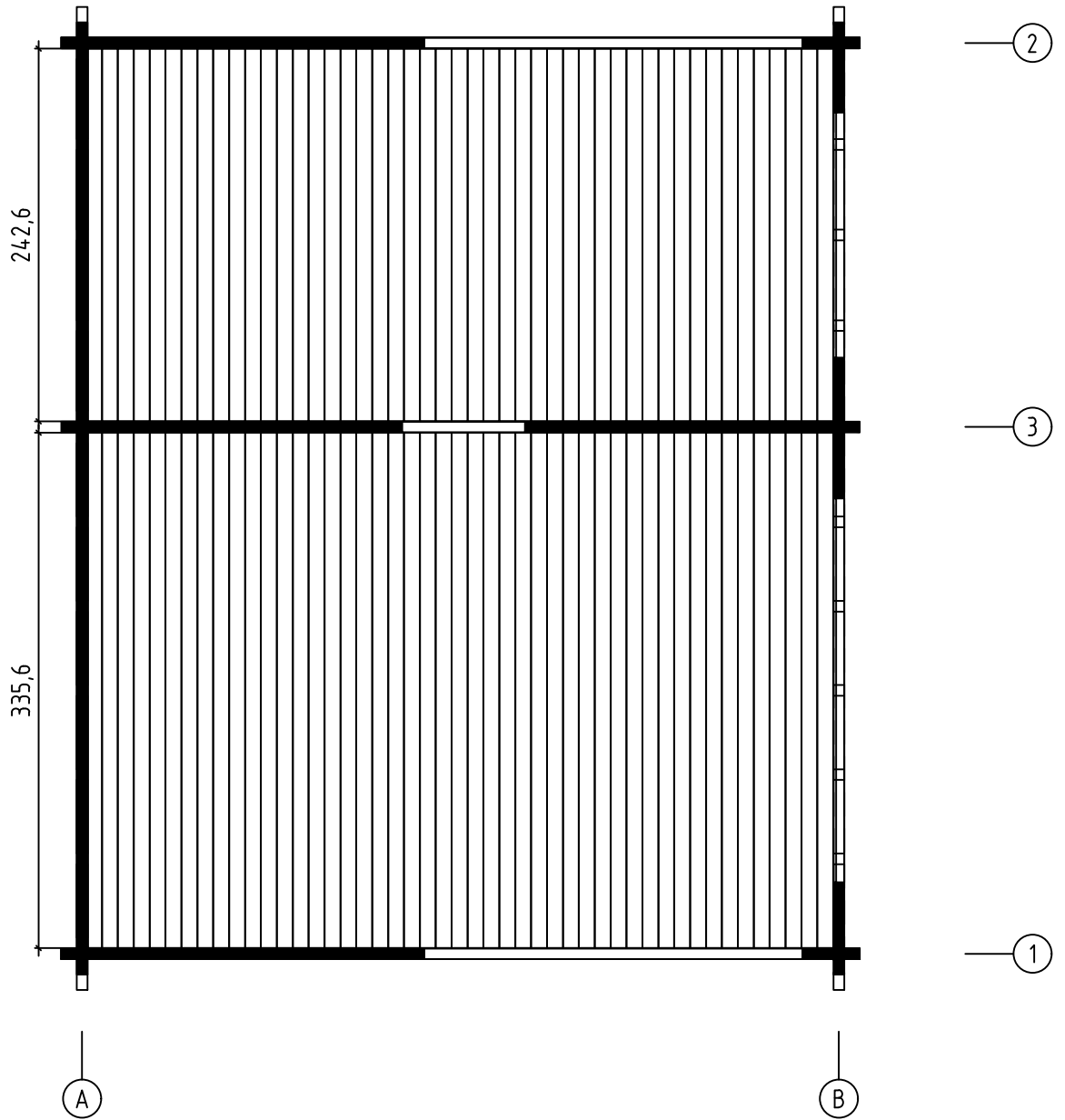

Malmö, Art.No.7015041

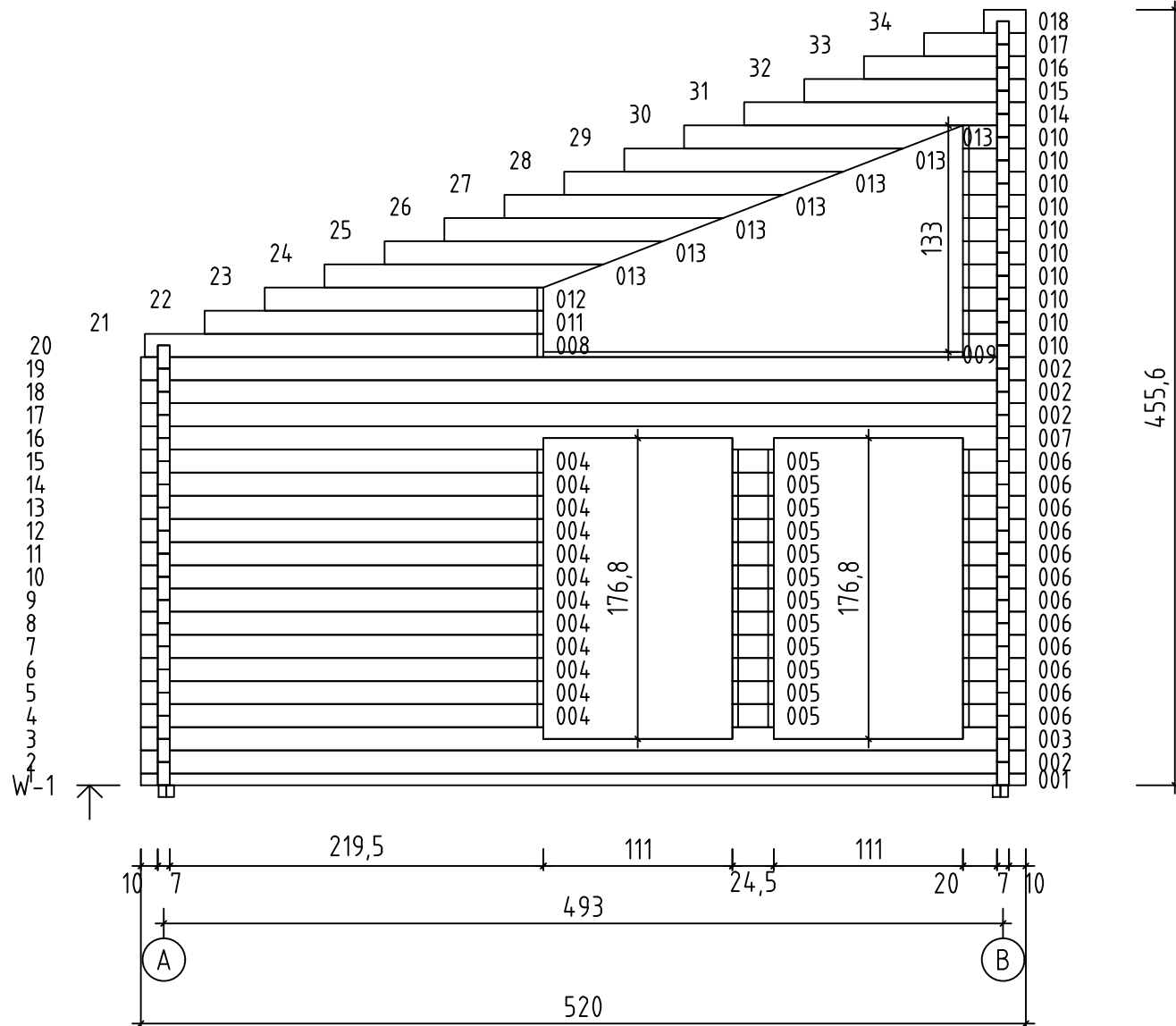

Malmö, Art.No.7015041

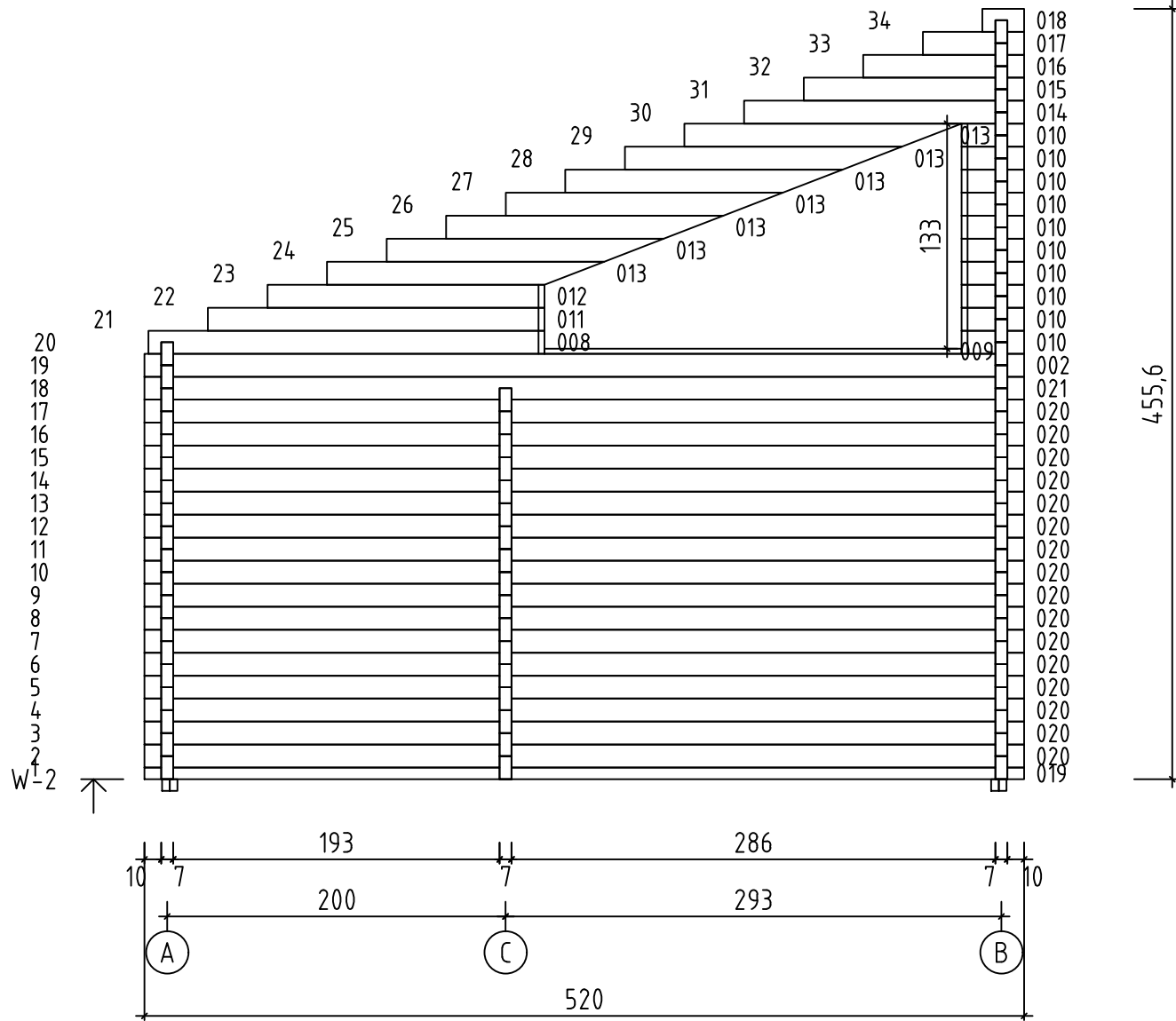

Malmö, Art.No.7015041

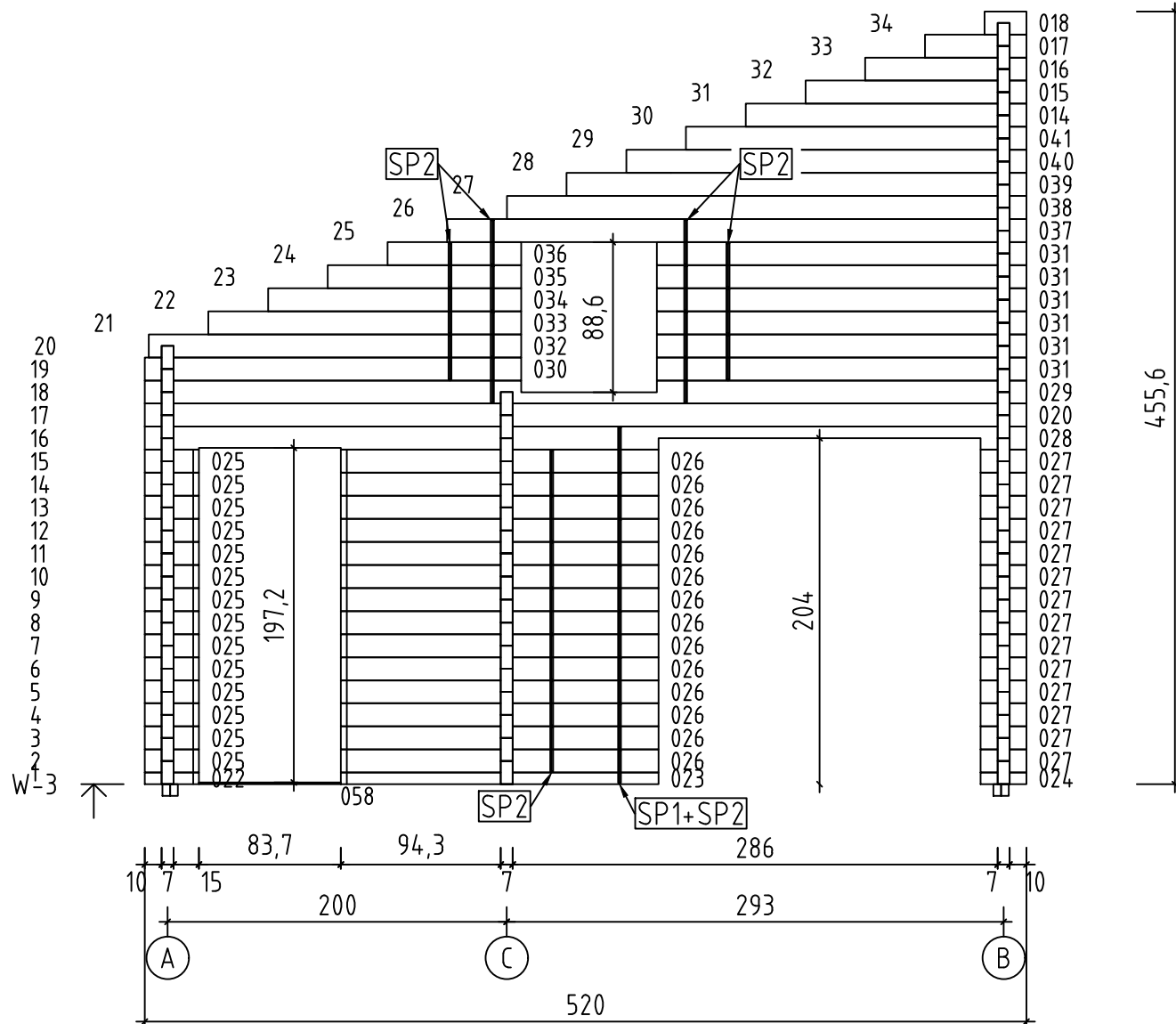

Malmö, Art.No.7015041

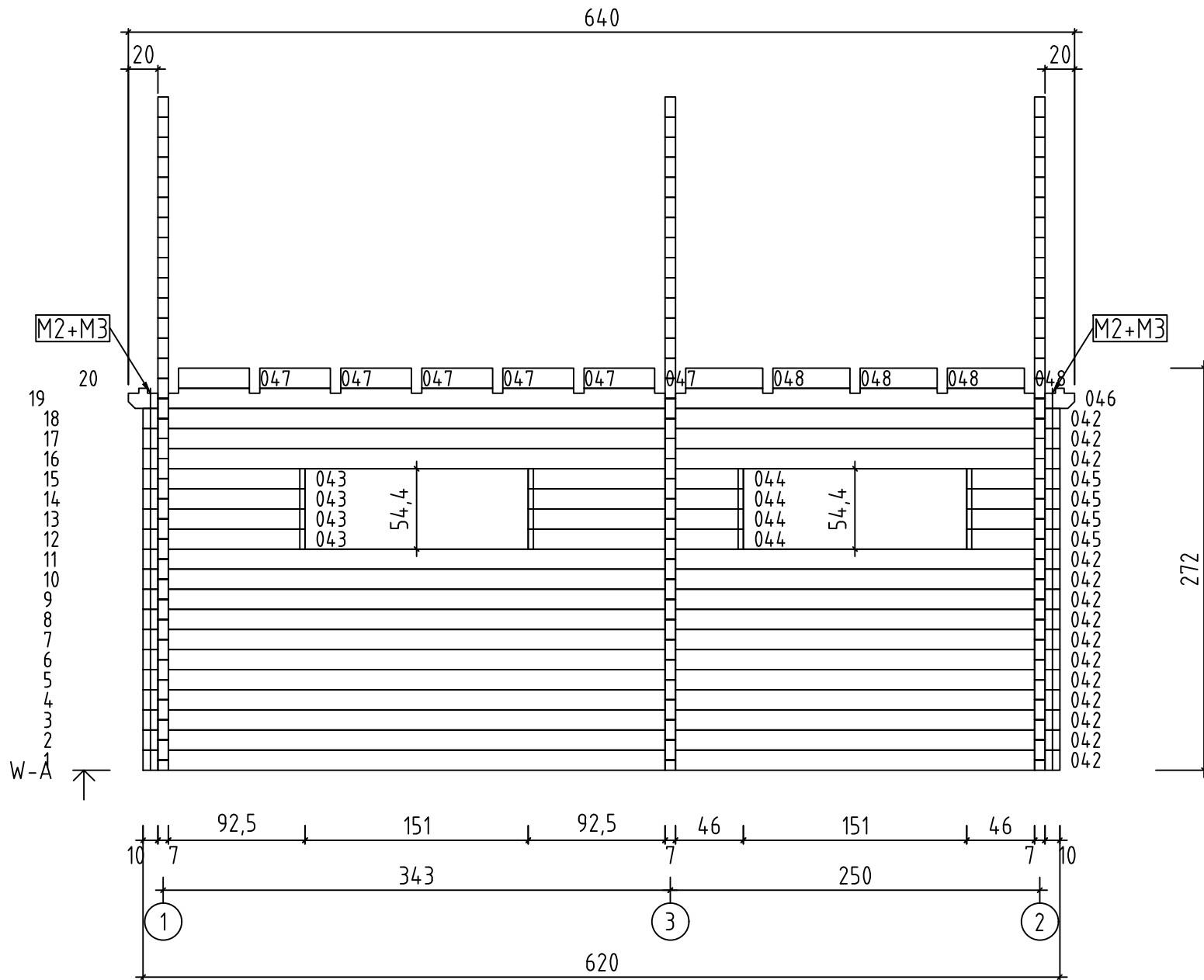



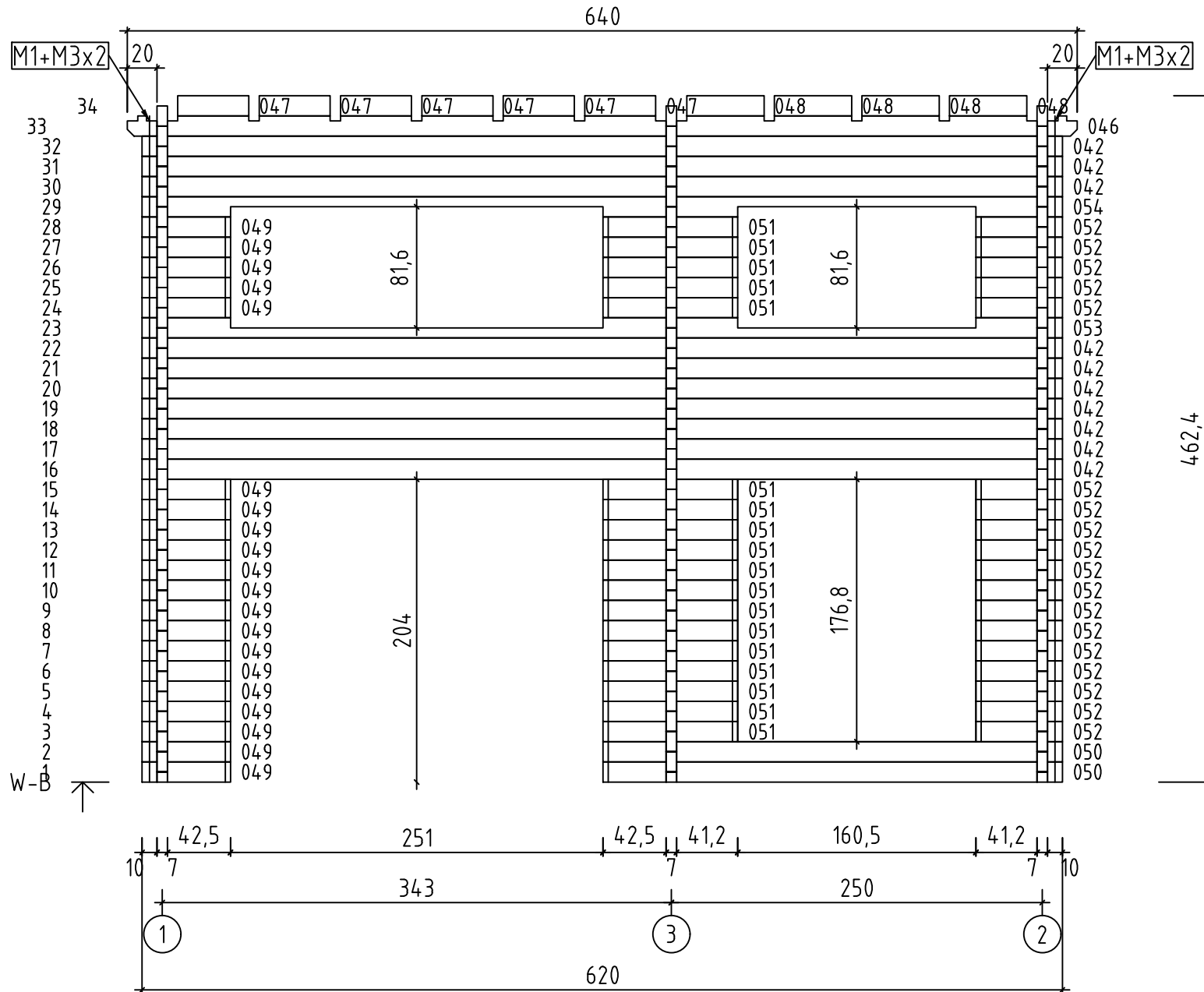



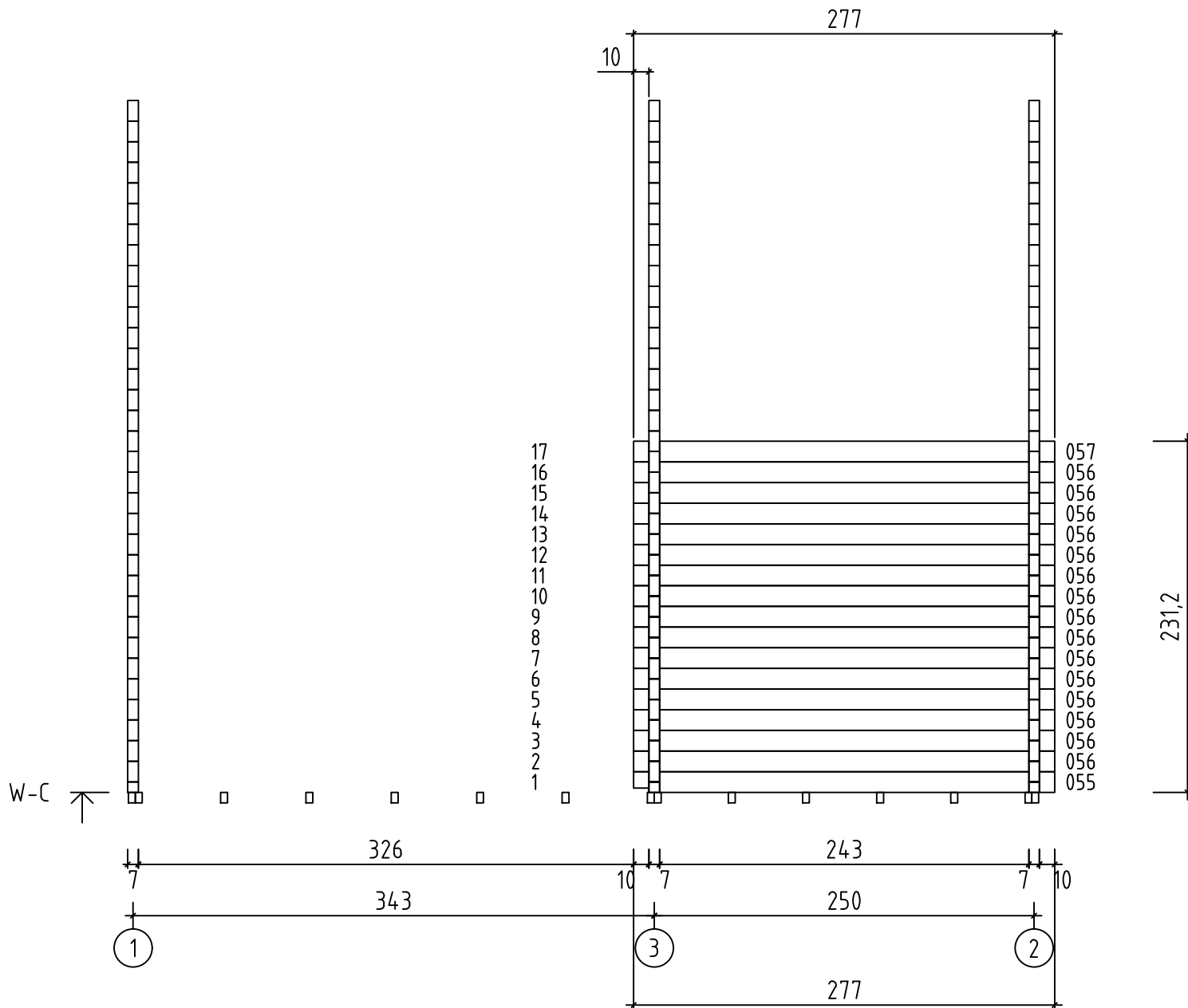

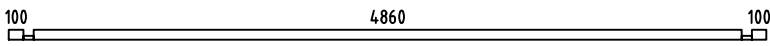
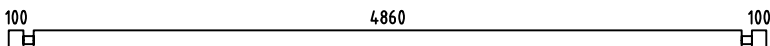
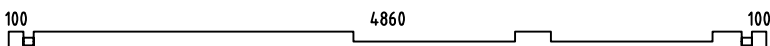
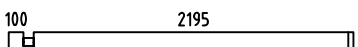

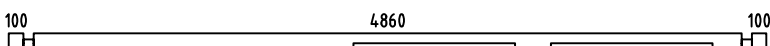
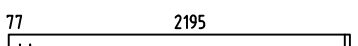
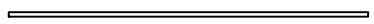

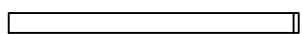

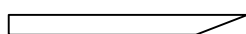
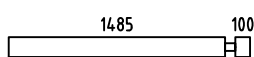
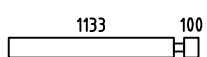
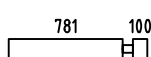
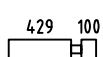

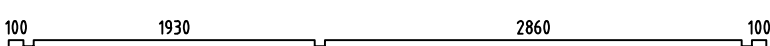
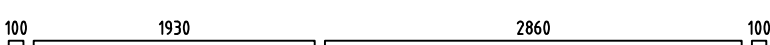

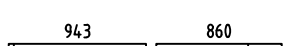

Malmö, Art.No.7015041

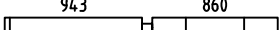



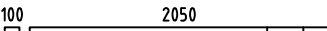
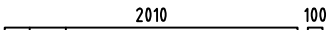
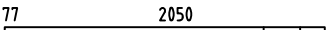
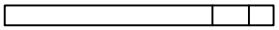
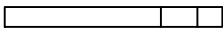
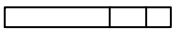
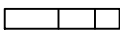
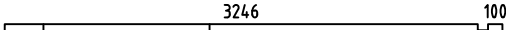
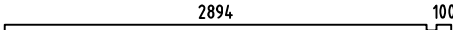
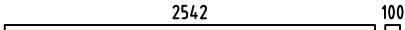
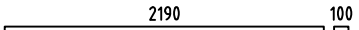
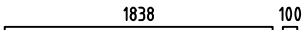

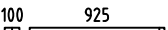

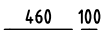
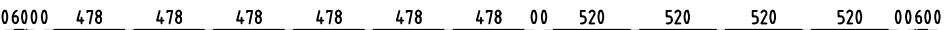

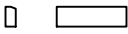
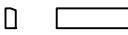

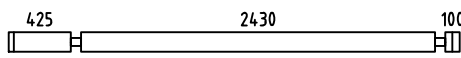
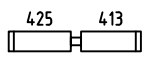

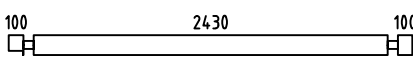
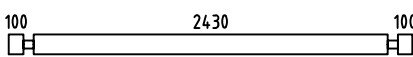
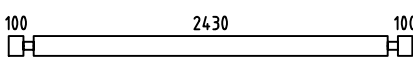

Malmö, Art.No.7015041

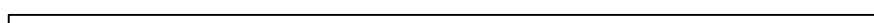

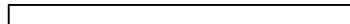
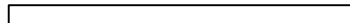
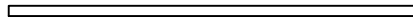
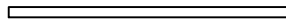
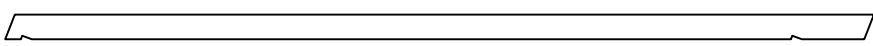
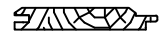
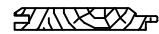
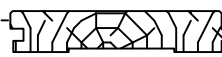







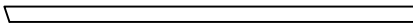
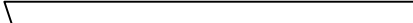
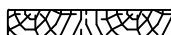

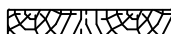

| Pos | Malmö, Art.No.7015041 Piece list - Stückliste - Liste des pièces - Elementi - Stuklijst - Tükítabel | Q | P (mm) | L (mm) |
|-----|--|----|-----------|-----------|
| 001 |  | 1 | 70x68 | 5200 |
| 002 |  | 5 | 70x136 | 5200 |
| 003 |  | 1 | 70x136 | 5200 |
| 004 |  | 12 | 70x136 | 2365 |
| 005 |  | 12 | 70x136 | 245 |
| 006 |  | 12 | 70x136 | 370 |
| 007 |  | 1 | 70x136 | 5200 |
| 008 |  | 2 | 70x136 | 2342 |
| 009 |  | 2 | 70x30 | 2466 |
| 010 |  | 20 | 70x136 | 369 |
| 011 |  | 2 | 70x136 | 1990 |
| 012 |  | 2 | 70x136 | 1638 |
| 013 |  | 14 | 70x136 | 1638 |
| 014 |  | 3 | 70x136 | 1655 |
| 015 |  | 3 | 70x136 | 1303 |
| 016 |  | 3 | 70x136 | 951 |
| 017 |  | 3 | 70x136 | 599 |
| 018 |  | 3 | 70x136 | 247 |
| 019 |  | 1 | 70x68 | 5200 |
| 020 |  | 17 | 70x136 | 5200 |
| 021 |  | 1 | 70x136 | 5200 |
| 022 |  | 1 | 70x68 | 320 |
| 023 |  | 1 | 70x68 | 1873 |

| Pos | Malmö, Art.No.7015041 Piece list - Stückliste - Liste des pièces - Elementi - Stuklijst - Tükitabel | Q | P (mm) | L (mm) |
|-----|--|----|-----------|-----------|
| 024 | 100 100  | 1 | 70x68 | 270 |
| 025 | 100 150  | 14 | 70x136 | 320 |
| 026 | 943 860  | 14 | 70x136 | 1873 |
| 027 | 100 100  | 14 | 70x136 | 270 |
| 028 | 100 1930 2860 100  | 1 | 70x136 | 5200 |
| 029 | 100 1930 2860 100  | 1 | 70x136 | 5200 |
| 030 | 100 2050  | 1 | 70x136 | 2220 |
| 031 | 2010 100  | 6 | 70x136 | 2180 |
| 032 | 77 2050  | 1 | 70x136 | 2197 |
| 033 |  | 1 | 70x136 | 1845 |
| 034 |  | 1 | 70x136 | 1493 |
| 035 |  | 1 | 70x136 | 1140 |
| 036 |  | 1 | 70x136 | 788 |
| 037 | 3246 100  | 1 | 70x136 | 3416 |
| 038 | 2894 100  | 1 | 70x136 | 3064 |
| 039 | 2542 100  | 1 | 70x136 | 2712 |
| 040 | 2190 100  | 1 | 70x136 | 2360 |
| 041 | 1838 100  | 1 | 70x136 | 2008 |
| 042 | 100 3360 2430 100  | 24 | 70x136 | 6200 |
| 043 | 100 925  | 4 | 70x136 | 1095 |
| 044 | 925 460  | 4 | 70x136 | 1455 |
| 045 | 460 100  | 4 | 70x136 | 630 |
| 046 | 06000 478 478 478 478 478 478 00 520 520 520 520 00600  | 2 | 70x136 | 6400 |

| Pos | Malmö, Art.No.7015041 Piece list - Stückliste - Liste des pièces - Elementi - Stuklijst - Tükitabel | Q | P (mm) | L (mm) |
|-------|---|----|-----------|-----------|
| 047 |  | 12 | 70x136 | 478 |
| 048 |  | 8 | 70x136 | 520 |
| 049 |  | 20 | 70x136 | 595 |
| 050 |  | 2 | 70x136 | 3095 |
| 051 |  | 18 | 70x136 | 908 |
| 052 |  | 18 | 70x136 | 583 |
| 053 |  | 1 | 70x136 | 6200 |
| 054 |  | 1 | 70x136 | 6200 |
| 055 |  | 1 | 70x136 | 2770 |
| 056 |  | 15 | 70x136 | 2770 |
| 057 |  | 1 | 70x136 | 2770 |
| 058 |  | 1 | 70x10 | 837 |
| IAR1 | Foundation - Fundament - Fondation - Fondamenta - Fundering - Immutatud alusraam  | 4 | 45x70 | 5990 |
| IAR2 | Foundation - Fundament - Fondation - Fondamenta - Fundering - Immutatud alusraam  | 15 | 45x70 | 4810 |
| VT2 | Mezzanine floor joists - Halbgeschoss balken - Solives de plancher mezzanine - Travi del pavimento mezzanino - Plaatduim scharnier - Vahelaetalad  | 8 | 70x140 | 2430 |
| VT1 | Mezzanine floor joists - Halbgeschoss balken - Solives de plancher mezzanine - Travi del pavimento mezzanino - Plaatduim scharnier - Vahelaetalad  | 4 | 45x140 | 2430 |
| VT4 | Mezzanine floor joists - Halbgeschoss balken - Solives de plancher mezzanine - Travi del pavimento mezzanino - Plaatduim scharnier - Vahelaetalad  | 2 | 45x70 | 2860 |
| VT3 | Mezzanine floor joists - Halbgeschoss balken - Solives de plancher mezzanine - Travi del pavimento mezzanino - Plaatduim scharnier - Vahelaetalad  | 2 | 45x70 | 1930 |
| SR1 | Rafter - Dachsparren - Chevron - Trave - Dak spar - Sarikas  | 16 | 70x170 | 5962 |
| STP-1 | Ceiling boards - Deckenbrett - Voliges sous plafond - Tavole per piano soffitto - Dakhout - Laelaud  | 47 | 111x14 | 3356 |
| STP-2 | Ceiling boards - Deckenbrett - Voliges sous plafond - Tavole per piano soffitto - Dakhout - Laelaud  | 47 | 111x14 | 2426 |
| HLL-1 | Floor boards - Fussbodenbretter - Lame de plancher - Pavimento - Vloerhout - Põrandalaud  | | 137x28 | 322 m. |
| | Roof boards - Dachbretter - Voliges - Perlina per tetto - Dakhout - Katuselaud  | 66 | 90x18 | 3353 |

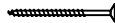
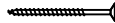
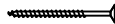
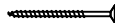
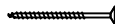
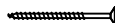
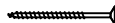
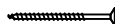
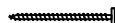
| Pos | Malmö, Art.No.7015041 Piece list - Stückliste - Liste des pièces - Elementi - Stuklijst - Tükítabel | Q | P (mm) | L (mm) |
|-------|---|----|-----------|-----------|
| | Roof boards - Dachbretter - Voliges - Perlina per tetto - Dakhout - Katuselaud  | 66 | 90x18 | 3047 |
| LL-1 | Ceiling fillet - Deckeleiste - Profil de finition sous plafond - Massello per soffitto - Dakafdekljst - Laeliist  | | 15x40 | 33 m. |
| FL-1 | Floor fillet - Fussbodenleiste - Corniere de finition du plancher - Finitura per pavimento (battisco pa) - Vloerafwerkljst - Põrandaliist  | | 15x40 | 45 m. |
| DPL-1 | Roofing felt fillet - Dachpappenleiste - Bague de fixation du feutre bitumeux - Asse per fissaggio guaina bituminosa - Afdekljst asfaltpapier - Katusepapiilist  | 4 | 18x58 | 2990 |
| DPL-2 | Roofing felt fillet - Dachpappenleiste - Bague de fixation du feutre bitumeux - Asse per fissaggio guaina bituminosa - Afdekljst asfaltpapier - Katusepapiilist  | 2 | 18x58 | 3236 |
| M1 | Treaded rod m12 - Gewindestange m12 - Tige filetée m12 - Barra filettata passo m12 - Draadstang 12m - Keermelatt  | 2 | | 500 |
| M2 | Treaded rod m12 - Gewindestange m12 - Tige filetée m12 - Barra filettata passo m12 - Draadstang 12m - Keermelatt  | 2 | | 600 |
| M3 | Treaded rod m12 - Gewindestange m12 - Tige filetée m12 - Barra filettata passo m12 - Draadstang 12m - Keermelatt  | 6 | | 2000 |
| TB-1 | Fascia board - Traufbrett - Bandeau de toit - Finitura lati tetto - Gevelljst - Räästalaud  | 2 | 18x120 | 2841 |
| TB-2 | Fascia board - Traufbrett - Bandeau de toit - Finitura lati tetto - Gevelljst - Räästalaud  | 2 | 18x120 | 3083 |
| TB-3 | Fascia board - Traufbrett - Bandeau de toit - Finitura lati tetto - Gevelljst - Räästalaud  | 2 | 18x120 | 3389 |
| TB-4 | Fascia board - Traufbrett - Bandeau de toit - Finitura lati tetto - Gevelljst - Räästalaud  | 2 | 18x120 | 3631 |
| TB-1 | Fascia board - Traufbrett - Bandeau de toit - Finitura lati tetto - Gevelljst - Räästalaud  | 2 | 18x90 | 3083 |
| TB-2 | Fascia board - Traufbrett - Bandeau de toit - Finitura lati tetto - Gevelljst - Räästalaud  | 2 | 18x90 | 3389 |
| TBE6 | Fixing fillet - Fixierungsleiste - Profil de fixation - Massello di fissaggio - Bevestiging lijstwerk - Tenderliist  | 2 | 28x34 | 340 |
| TBE6 | Fixing fillet - Fixierungsleiste - Profil de fixation - Massello di fissaggio - Bevestiging lijstwerk - Tenderliist  | 4 | 28x34 | 510 |
| TBE6 | Fixing fillet - Fixierungsleiste - Profil de fixation - Massello di fissaggio - Bevestiging lijstwerk - Tenderliist  | 4 | 28x34 | 645 |
| TBE6 | Fixing fillet - Fixierungsleiste - Profil de fixation - Massello di fissaggio - Bevestiging lijstwerk - Tenderliist  | 2 | 28x34 | 1290 |
| TBE6 | Fixing fillet - Fixierungsleiste - Profil de fixation - Massello di fissaggio - Bevestiging lijstwerk - Tenderliist  | 4 | 28x34 | 1592 |
| TBE6 | Fixing fillet - Fixierungsleiste - Profil de fixation - Massello di fissaggio - Bevestiging lijstwerk - Tenderliist  | 2 | 28x34 | 1729 |
| TBE6 | Fixing fillet - Fixierungsleiste - Profil de fixation - Massello di fissaggio - Bevestiging lijstwerk - Tenderliist  | 2 | 28x34 | 1922 |
| TBE6 | Fixing fillet - Fixierungsleiste - Profil de fixation - Massello di fissaggio - Bevestiging lijstwerk - Tenderliist  | 2 | 28x34 | 2000 |
| GL3 | Gable moulding - Giebelleiste - Planche de rive - Finitura per frontale e retro del tetto - Gevelljst - Viilulaud  | 2 | 18x90 | 3000 |

| Pos | Malmö, Art.No.7015041 Piece list - Stückliste - Liste des pièces - Elementi - Stuklijst - Tükítabel | Q | P (mm) | L (mm) |
|------|--|-----|-----------|-----------|
| GL3 | Gable moulding - Giebelleiste - Planche de rive - Finitura per frontale e retro del tetto - Gevellijst - Viilulaud  | 2 | 18x90 | 3000 |
| GL-1 | Gable moulding - Giebelleiste - Planche de rive - Finitura per frontale e retro del tetto - Gevellijst - Viilulaud  | 2 | 18x120 | 2983 |
| GL-1 | Gable moulding - Giebelleiste - Planche de rive - Finitura per frontale e retro del tetto - Gevellijst - Viilulaud  | 2 | 18x120 | 2983 |
| GL-2 | Gable moulding - Giebelleiste - Planche de rive - Finitura per frontale e retro del tetto - Gevellijst - Viilulaud  | 2 | 18x120 | 3000 |
| GL-2 | Gable moulding - Giebelleiste - Planche de rive - Finitura per frontale e retro del tetto - Gevellijst - Viilulaud  | 2 | 18x120 | 3000 |
| KL4 | Lengthening bolt for threaded rod - Verlängerungsmutter für gewindestange - Manchon de raccordement de tige filetée - Bullone per barra filettata passo - Extensie moer voor draadstang - Jätkumutter keermelatile  | 6 | | |
| KL1 | Drive nut threaded rod - Einschlagmutter für gewindestange - Écrou a frapper pour tige filetée - Dado guida per barra filettata - Aandrijfmoer / aanslagmoer voor draadstang - Löökmutter keermelatile  | 4 | | |
| KL2 | Nut for threaded rod - Mutter für gewindestange - Écrou pour tige filetée - Dado per barra filettata - Moer voor draadstang - Mutter keermelatile  | 4 | | |
| KL3 | Plain washer threaded rod - Unterlegscheibe für gewindestange - Rondelle plate pour tige filetée - Rondella per barra filettata - Sluistring voor draadeind - Seib keermelatile  | 4 | | |
| HS25 | Screw for floor - Schrauben für fussbodenbretter - Vis pour plancher - Viti per le perline del pavimento - Schroef voor vloerhout - Krugi põrandale  | 726 | 3.5x50 | |
| HS32 | Screw for fascia boards - Schrauben für traufbretter - Vis pour fixation bandeau de toit - Viti x striscia del tetto - Schroef voor gevelijst - Krugi räästalaualle  | 140 | 3.5x50 | |
| HS84 | Screw for fixing fillet of door and window - Schrauben für fixierungleiste - Vis pour profil vertical de fixation pour ouvertures des fenetres et portes - Viti per massello di fissaggio - Schroeven voor bevestiging van deur en raam lijsten - Krugi tenderliistudele  | 94 | 3.5x50 | |
| HS16 | Screw for gable moulding - Schrauben für giebelleiste - Vis pour fixation planche de rive - Vite per fissare finiture davanti e dietro del tetto - Schroef voor gevelijst - Krugi viilulauale  | 120 | 3.5x50 | |
| NFD | Screw for roofing felt fillet - Schrauben für dachpappenleiste - Vis pour fixation baguette de fixation feutre bitumeux - Vite per massellino del feltro del tetto - Schroef voor asfaltpaier afdekljst - Krugi katusepapiliistule  | 44 | 4x40 | |
| HS36 | Screw for stepladder - Schraube für leiter - Vis d'assemblage des marches de l'échelle - Vite per scaletta - Schroef voor trapladder - Krugi redeli montaažiks  | 36 | 4x60 | |
| HS89 | Screw for loft support - Schraube für dachbefestigung - Vis pour cornière de renfort de fixation - Viti per supporto del soppalco - Schroef voor dakbevestiging - Krugi vahelae kandurliistule  | 96 | 5x100 | |
| HS40 | Screw for 1. wall beam - Schraube für 1. bohnenreihe - Vis de fixations 1ere rangée de madriers avec poutrelles de fondations - Vite fissaggio alle fondamenta - Schroef voor 1 wandbalk - Krugi poolaualle  | 15 | 5x120 | |
| HS39 | Screw for foundation - Schrauben zur befestigung fundament - Vis de fixations des poutrelles de fondations - Viti x fondamenta - Schroef voor fundering - Krugi alusraamile  | 46 | 5x90 | |
| HS15 | Screw for wall details - Schraube für wand details - Vis pour mur details - Viti per elementi della porta - Schroef voor wand details - Krugi seinadetailidele  | 78 | 6x180 | |
| HS44 | Screw for rafter - Schrauben für dachsparren - Vis pour chevron - Vite per trave - Schroef voor dakspar - Krugi sarikatele  | 32 | 8x220 | |
| MS | Screw for doorstep - Schrauben für swelle - Vis pour fixation barre de seuil - Vite per soglia della porta - Schroef voor deurdorpel - Krugi lävepakule  | 7 | 4.5x65 | |
| SH70 | Hammer block - Schlagholz - Calle de frappe - Blocco di legno da usare come cuscinetto quando si usa il martello - Slagklos - Löögiklots  | 2 | | |
| NFC | Zn nail for ceiling fillet - Zn nägel deckeleiste - Pointe pour profil de finition sous plafond - Chiodi zincati per massellini del soffitto - Spijker(nagel) voor plafond afdekljst - Nael laeliistule  | 66 | 1.4x40 | |

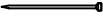
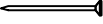
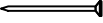
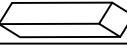
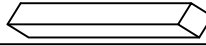
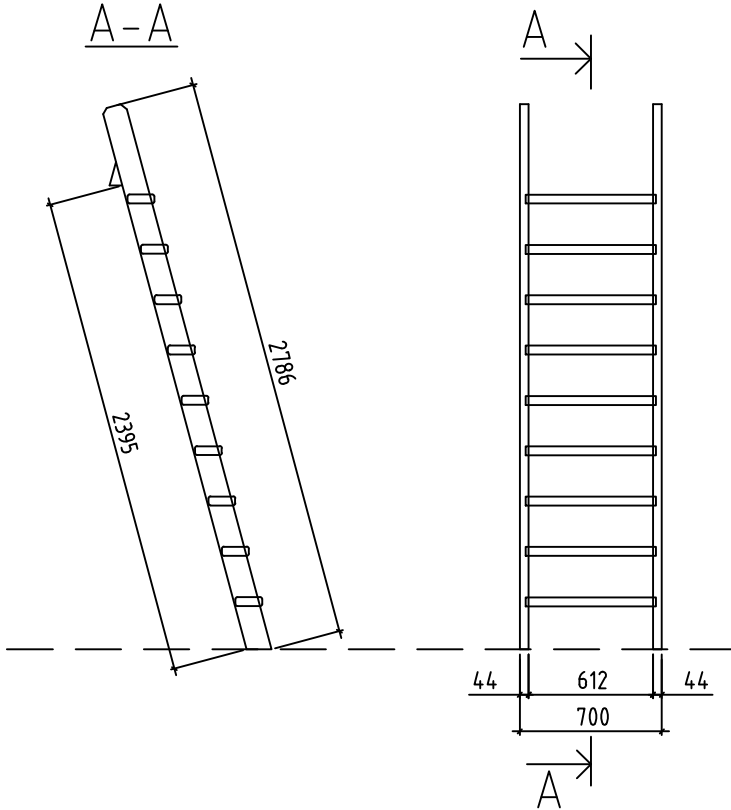
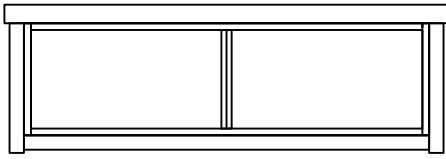
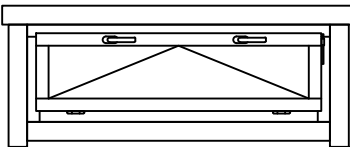
| Pos | Malmö, Art.No.7015041 Piece list - Stückliste - Liste des pièces - Elementi - Stuklijst - Tükítabel | Q | P (mm) | L (mm) |
|-----|---|------|-----------|-----------|
| NFF | Zn nail for floor fillet - Zn năgel für fussbodenteiste - Pointe pour corniere de finition du plancher - Chiodi x fissaggio pavimento - Spijker(nagel) voor vloer afdekljst - Nael pörändalistule  | 90 | 1.4x40 | |
| NF2 | Zn nail for roof - Zn năgel für dachbretter - Pointe pour fixation voliges de toit - Chiodi x perline tetto - Spijker(nagel) voor dakhout - Nael katuselauale  | 1122 | 2.1x50 | |
| NF2 | Zn nail for ceiling boards - Zn năgel für deckenbretter - Clous pour voliges sous plafonds - Chiodo per il tavolo del soffitto - Spijkers voor plafondplaat - Nael laelauale  | 658 | 2.1x50 | |
| ORZ | Montage set for doors and windows - Montage set für türen und fenster - Jeu de montage portes et fenetres - Set di assemblaggio per porte e finestre - Montage set voor deur en raam - Orthez akna ja ukse montaaživahendid | 1 | | |
| SP1 | Hidden fixing - Holzdübel - Tourillon bois - Fissaggio a scomparsa - Verloren kop spijker  | 1 | | |
| SP2 | Hidden fixing - Holzdübel - Tourillon bois - Fissaggio a scomparsa - Verloren kop spijker  | 28 | | |
| LR | Ladder - Leiter - Echelle - Scala a pioli - Ladder - Redel  | 1 | | |
| | Window - Fenster - Fenetre - Finestra - Raam - Aken  2500x780 2+ A.0M.K | 1 | | |
| | Window - Fenster - Fenetre - Finestra - Raam - Aken  1500x510 2+ A.0Ü.K | 2 | | |

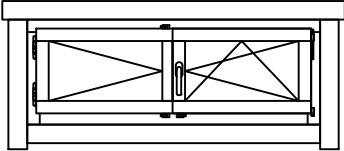
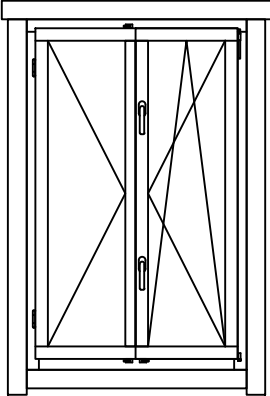
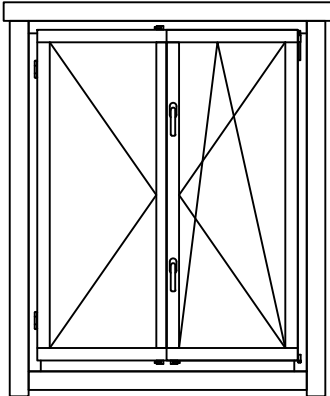
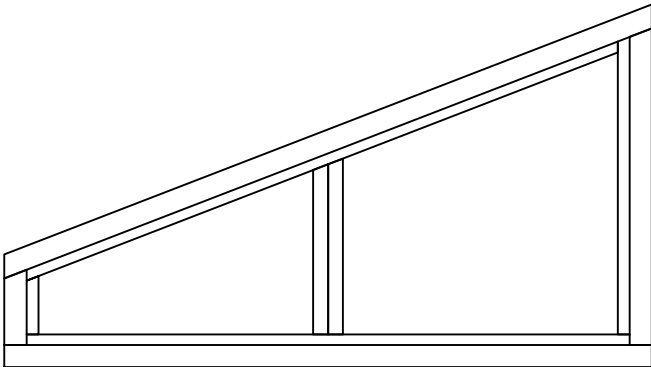
| Pos | Malmö, Art.No.7015041 Piece list - Stückliste - Liste des pièces - Elementi - Stuklijst - Tükitabel | Q | P (mm) | L (mm) |
|-----|---|---|-----------|-----------|
| | Window - Fenster - Fenetre - Finestra - Raam - Aken 1595x780 2+ TA.0P.bK  | 1 | | |
| | Window - Fenster - Fenetre - Finestra - Raam - Aken 1100x1729 2+ TA.0P.bK  | 2 | | |
| | Window - Fenster - Fenetre - Finestra - Raam - Aken 1595x1729 2+ TA.0P.bK  | 1 | | |
| | Window - Fenster - Fenetre - Finestra - Raam - Aken 2455x1284 2+ KA.0P.K  | 1 | | |
| | | | | |

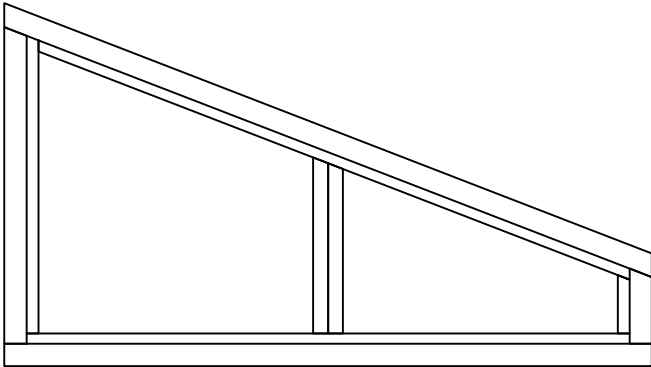
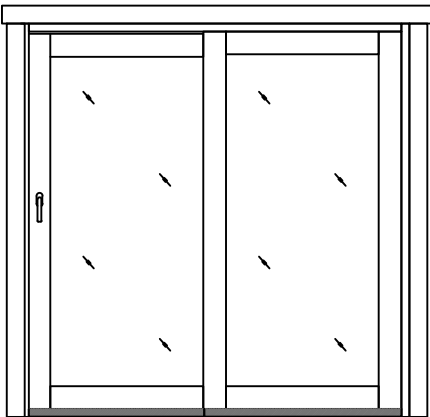
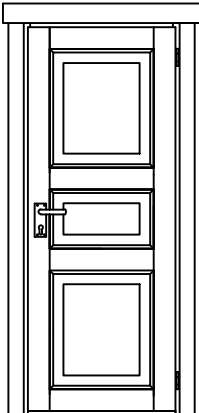
| Pos | Malmö, Art.No.7015041 Piece list - Stückliste - Liste des pièces - Elementi - Stuklijst - Tükitabel | Q | P (mm) | L (mm) |
|-----|---|---|-----------|-----------|
| | <p>Window - Fenster - Fenetre - Finestra - Raam - Aken 2455x1284 2+ KA.0V.K</p>  | 1 | | |
| | <p>Door - Tür - Porte - Porte - Deur - Uks 2500x2000 3+ TU2L.10P.K</p>  | 1 | | |
| | <p>Door - Tür - Porte - Porte - Deur - Uks 827x1933 U.3TP</p>  | 1 | | |
| | | | | |
| | | | | |
| | | | | |
| | | | | |
| | | | | |

