

Hawaii
Art. Nr. 4410693
1/13

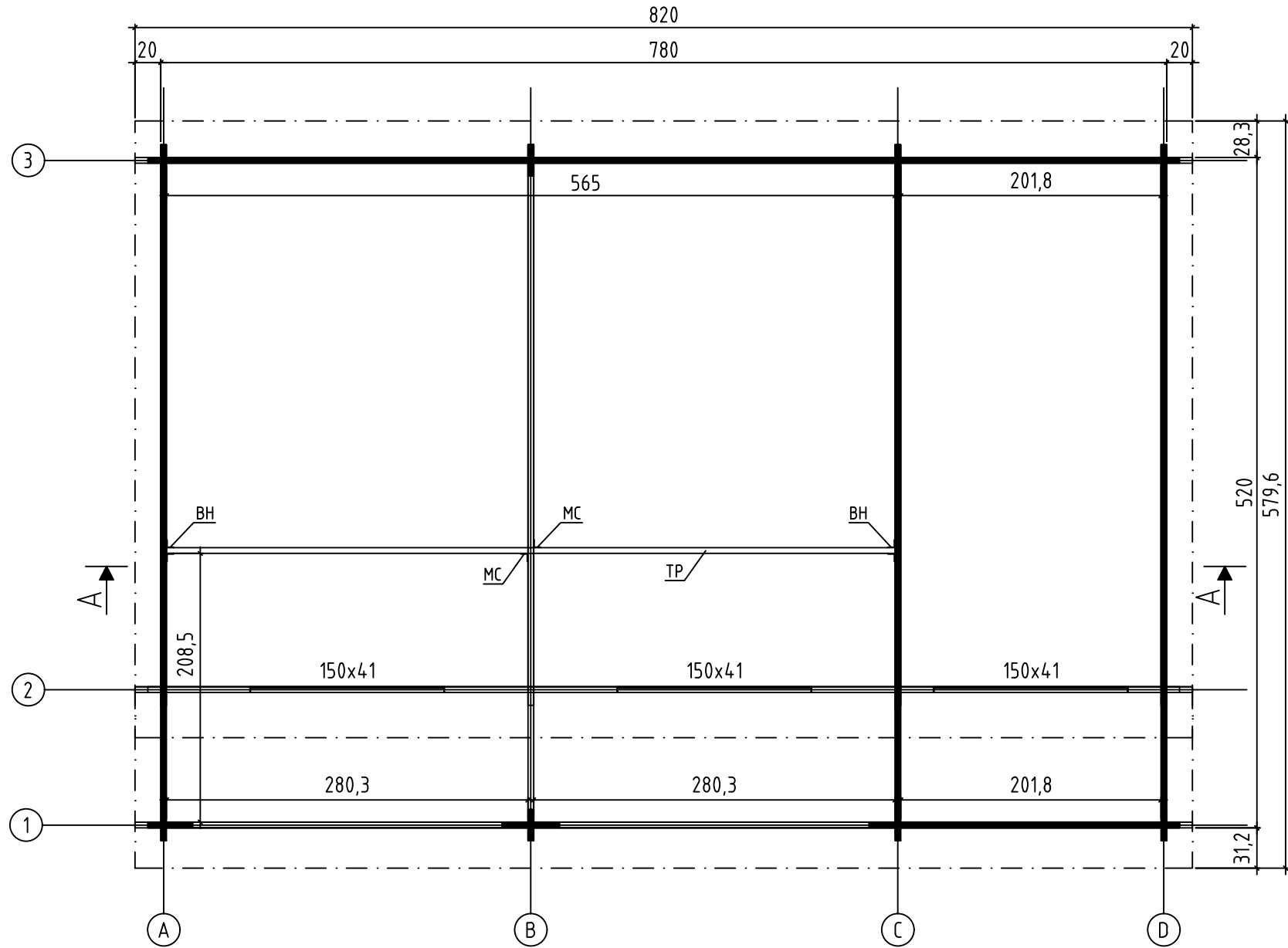

18.01.2017

Art.Nr. 4410693
GROUNDPLAN - GRUNDPLAN - PLAN DE MASSE



Art.Nr. 4410693
FOUNDATION - FUNDAMENT - FONDATION

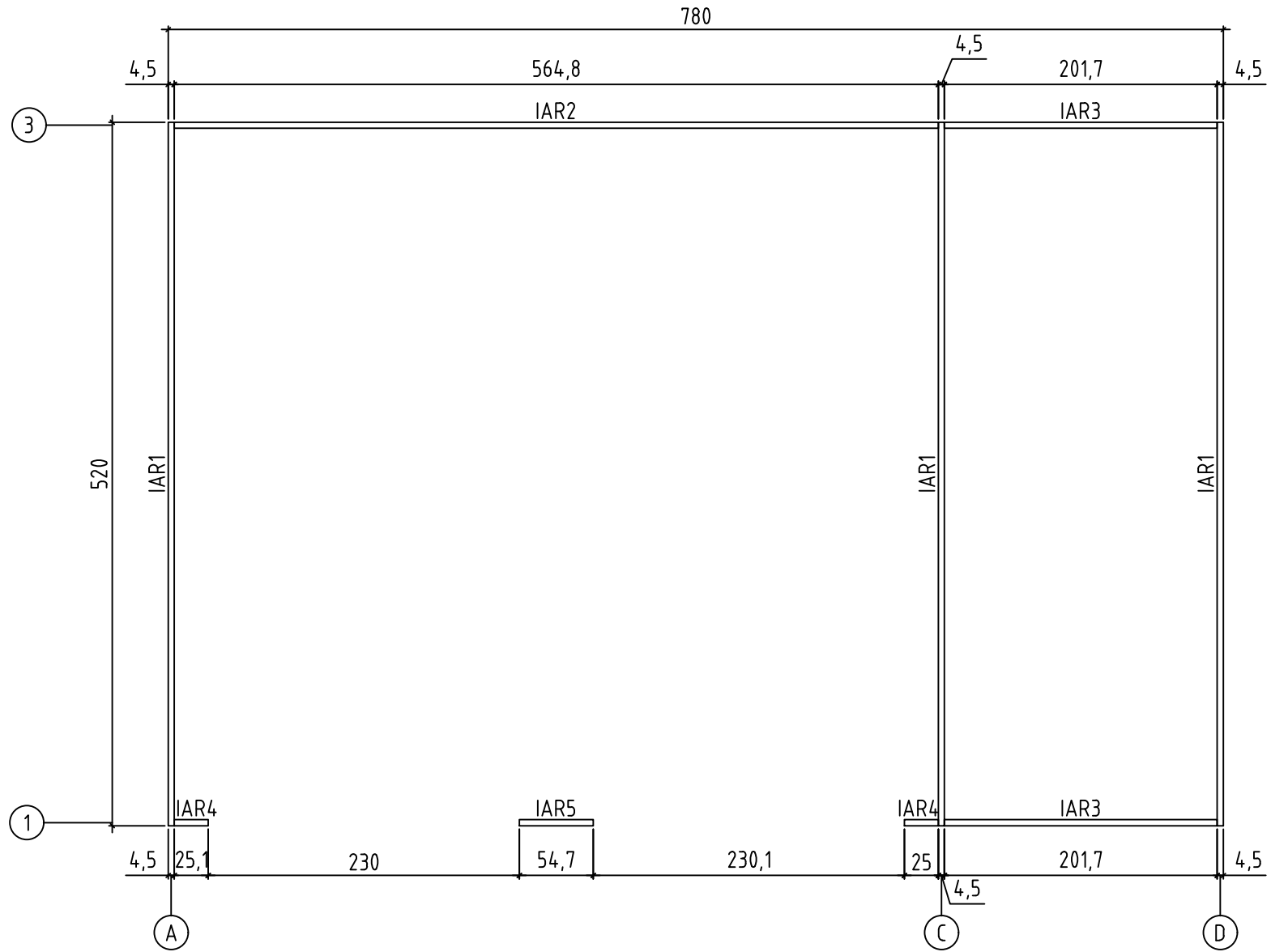

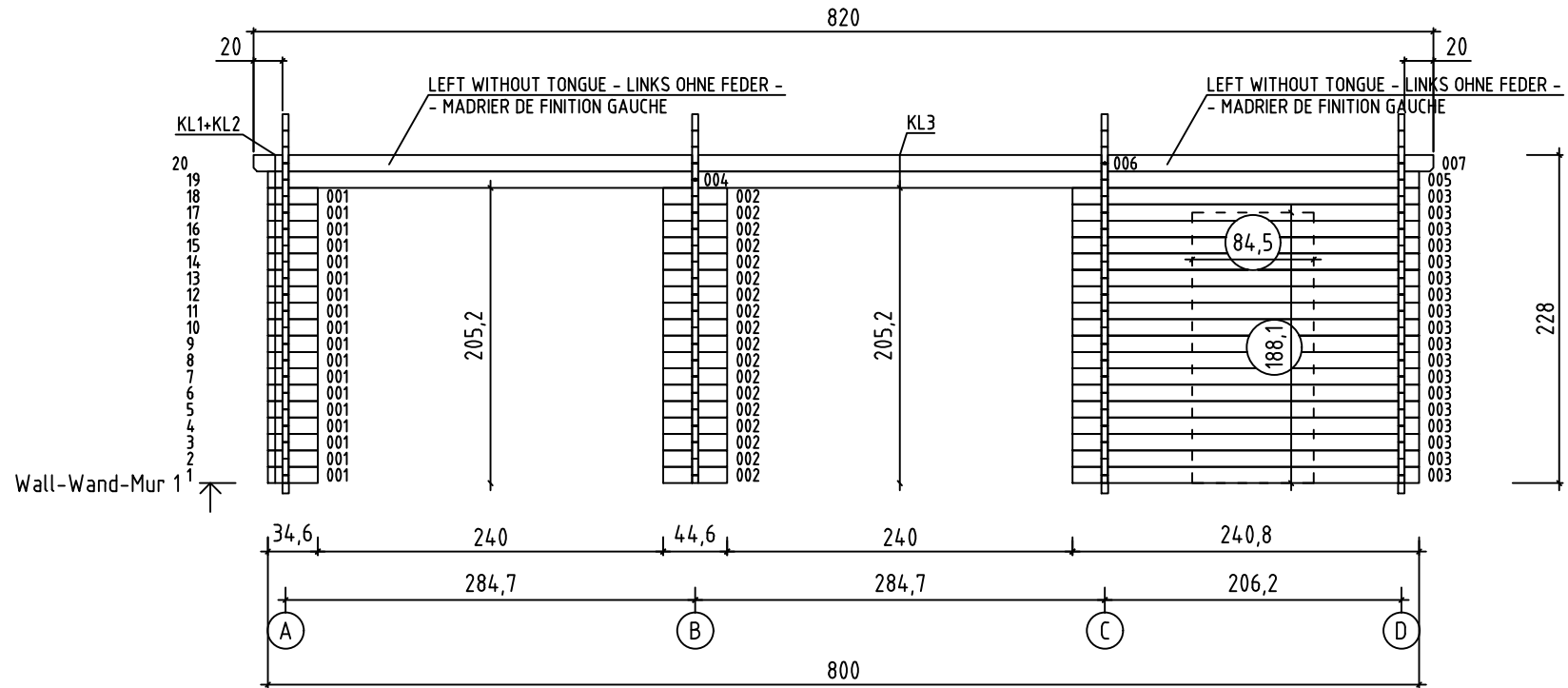

A SINGLE DOOR (83.5x185 CM) HAS BEEN DELIVERED TOGETHER WITH THE BUILDING. YOU CAN CHOOSE THE LOCATION FOR THE DOOR BY YOURSELF BY CUTTING THE WALL LOGS AS SHOWN IN THE PICTURE (SEE THE DOTTED LINE)

IM LIEFERUMFANG IST EINE EINZELTÜR ENTHALTEN. DAFÜR SIND ABER WERKSSEITIG KEINE AUSSPARUNGEN VORGESEHEN SO DASS SIE TÜR INDIVIDUELL VERBAUEN KÖNNEN. EINE ANLEITUNG HIERFÜR ENTNEHMEN SIE BITTE DER MONTAGEANLEITUNG (SIEHE BILD)

LE POSITIONNEMENT DE LA PORTE DE SERVICE NÉCESSITE LA DÉCOUPE PRÉALABLE DES MADRIERS. VEILLEZ RESPECTER LES COTES DE DÉCOUPES DANS LES MADRIERS INDIQUÉES SUR LE SCHÉMA. VOUS POUVEZ POSITIONNER, SELON VOTRE CONVENANCE, LES OUVERTURES DE CHAQUE CÔTÉ OU À L'ARRIÈRE DU GARAGE.



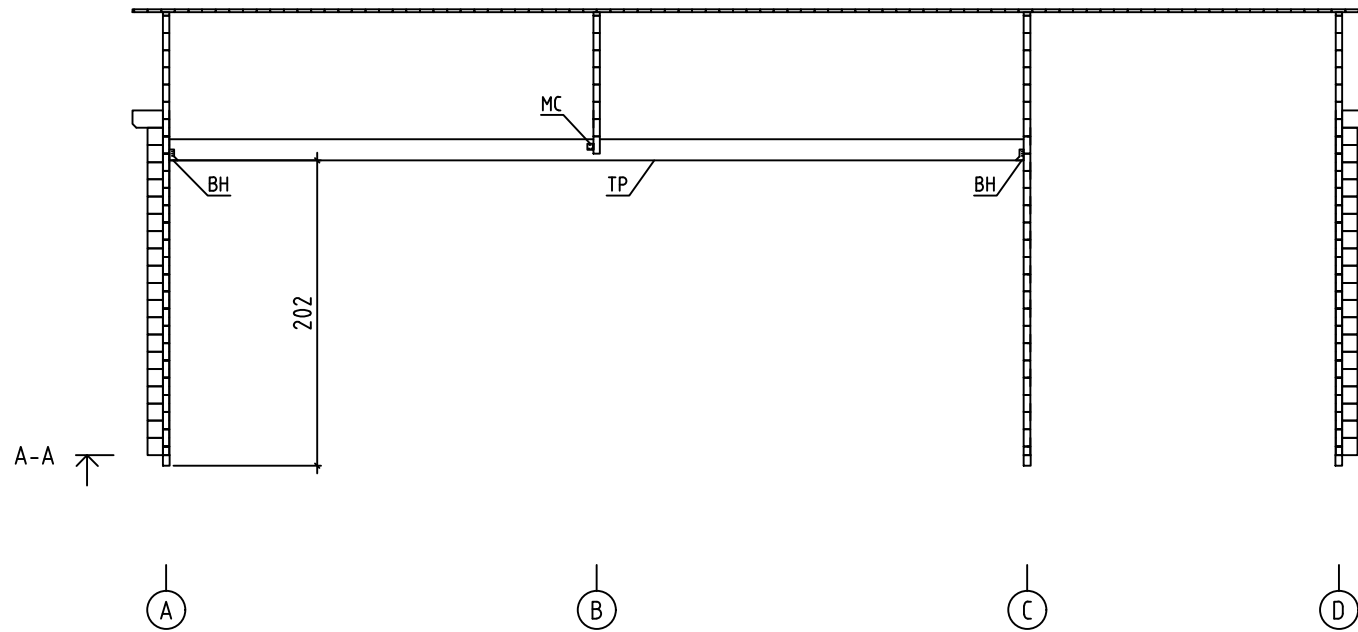

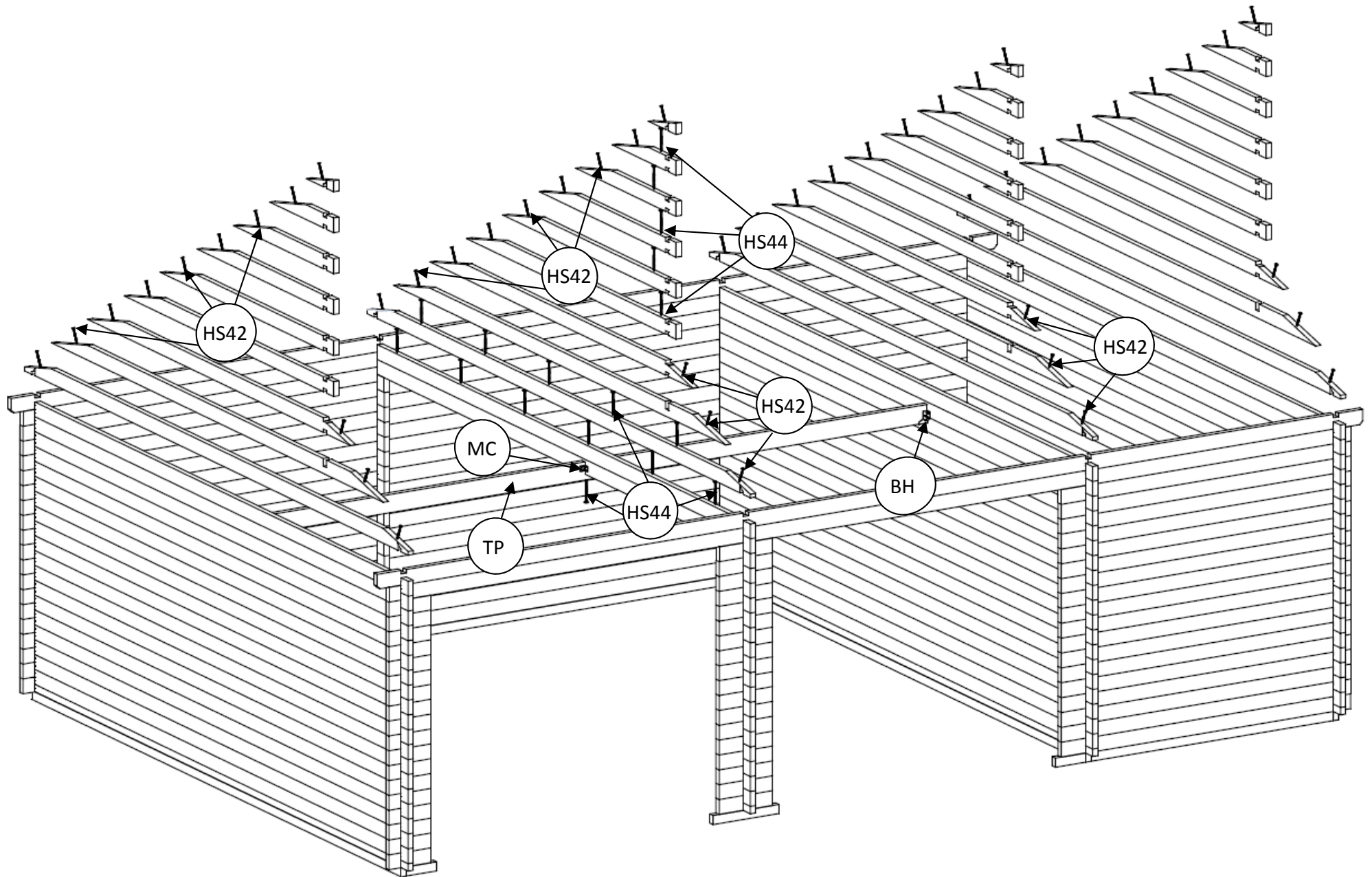

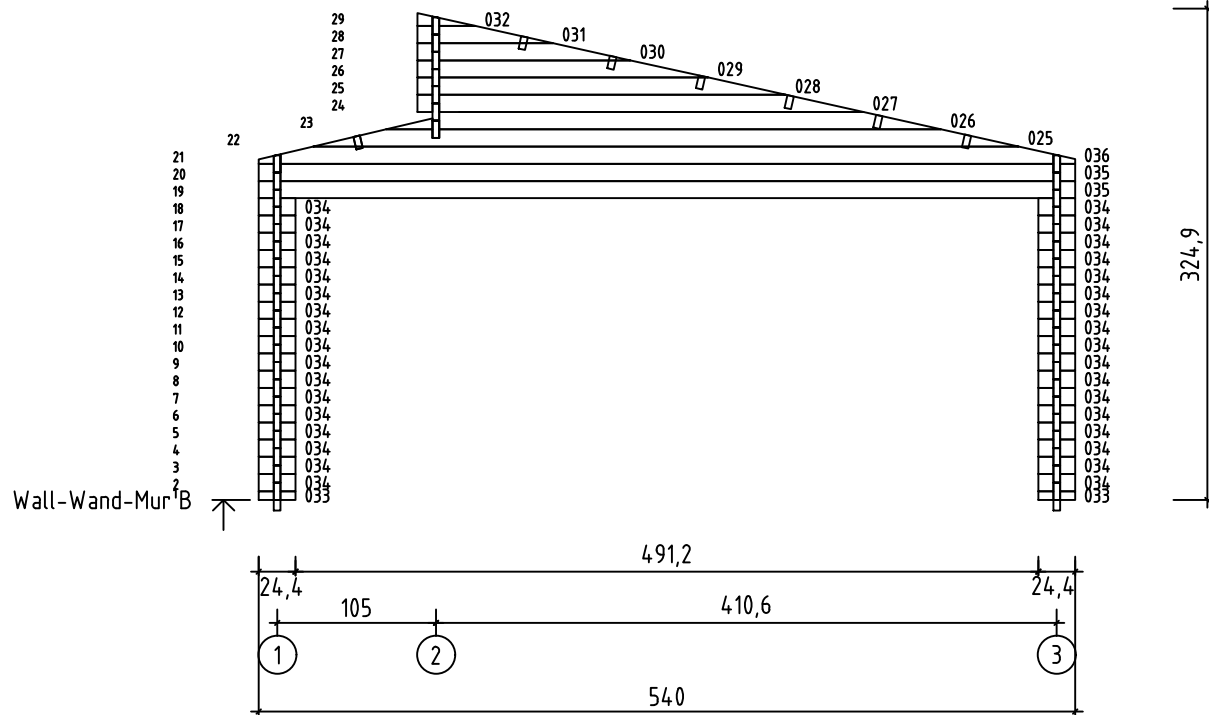
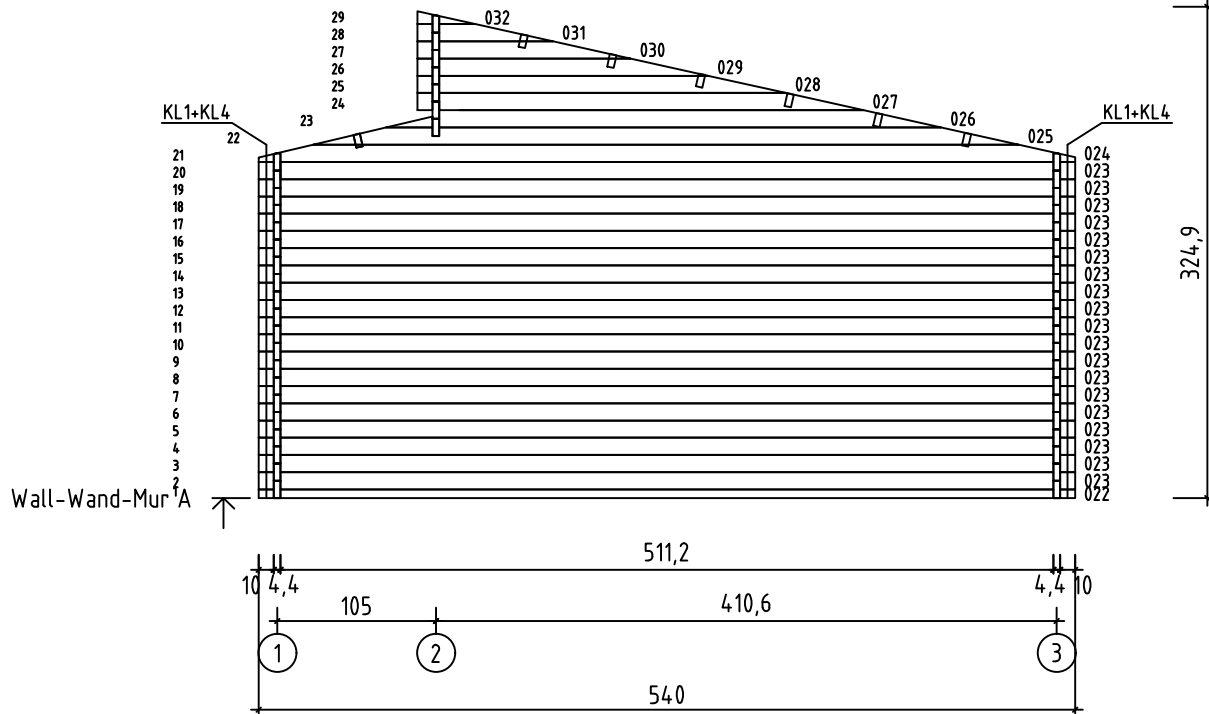

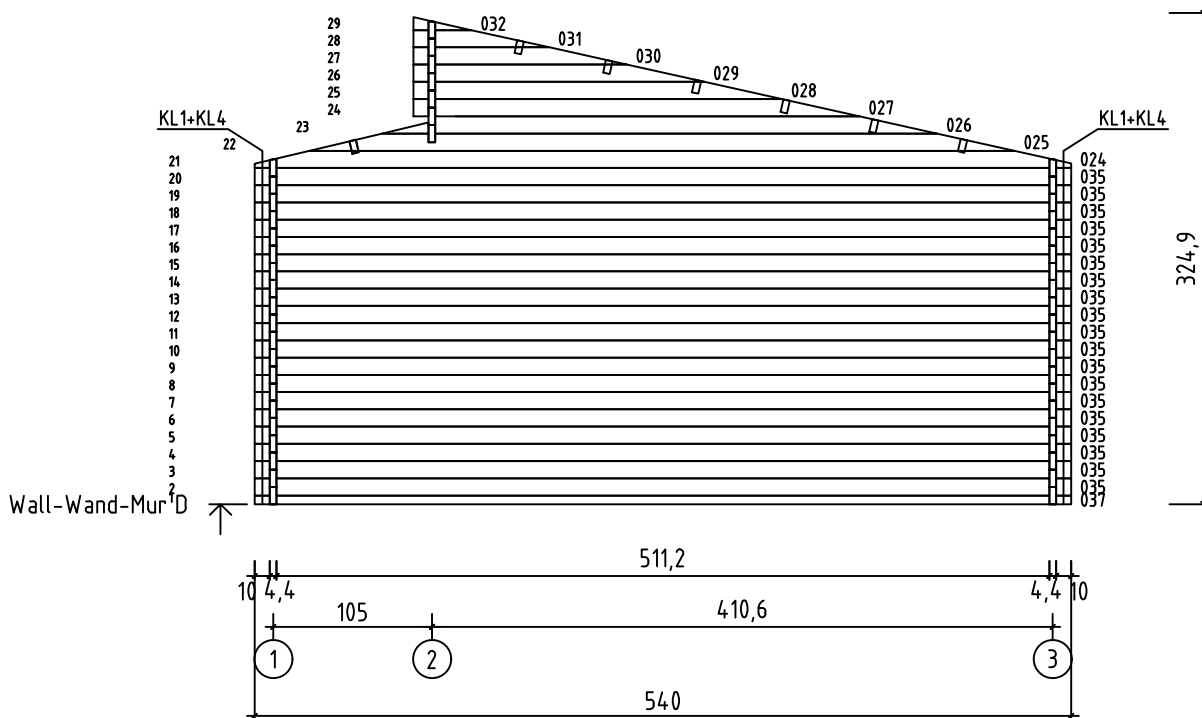
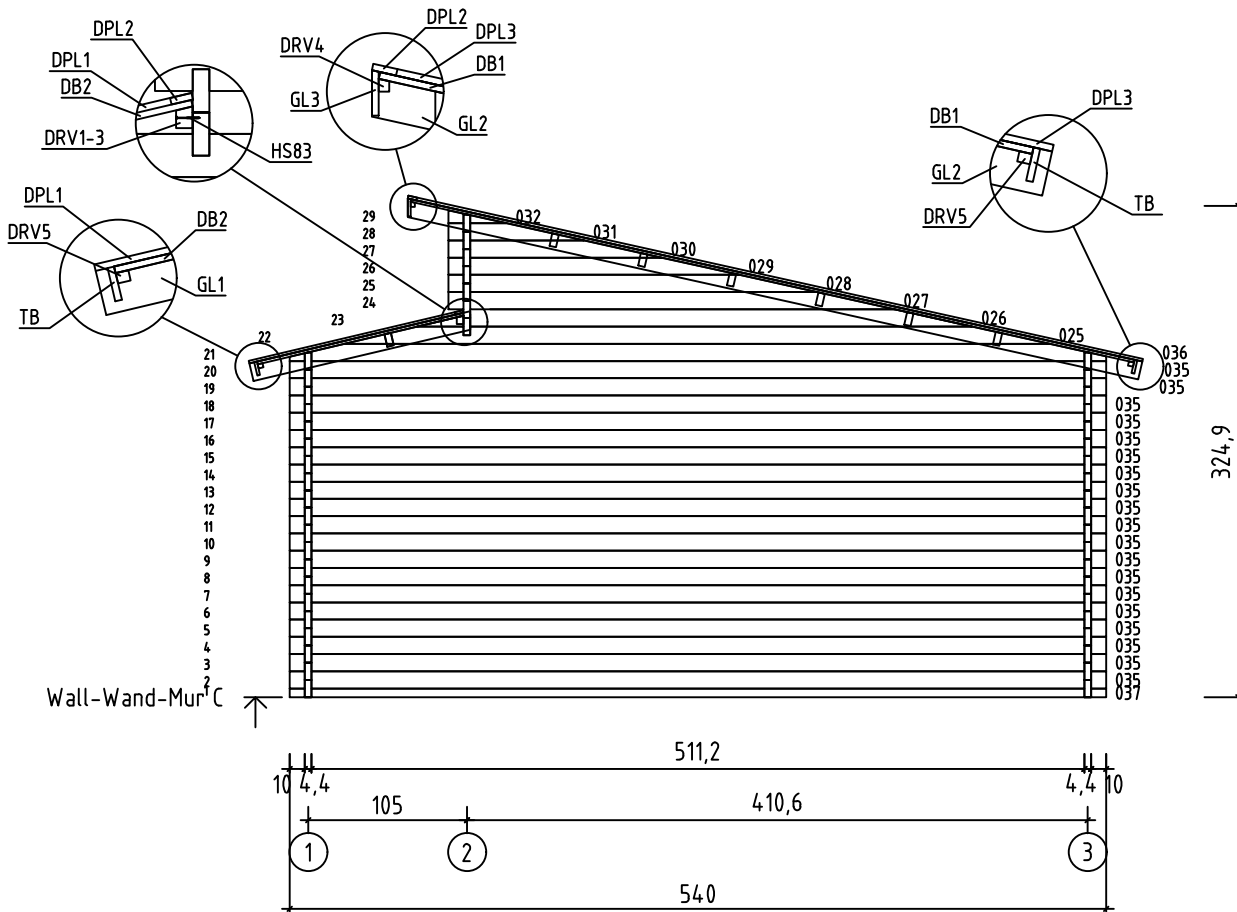
Art.Nr. 4410693



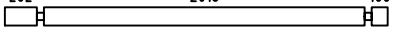
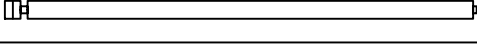
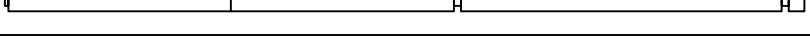
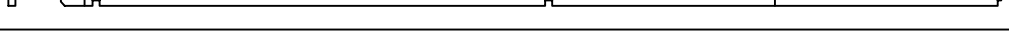
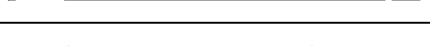
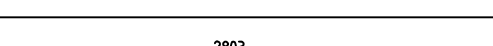
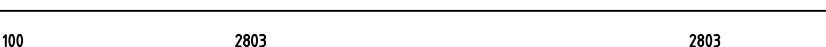
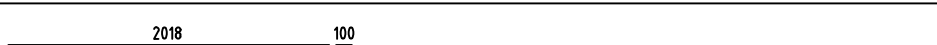

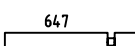
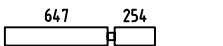
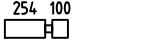

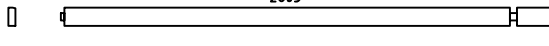
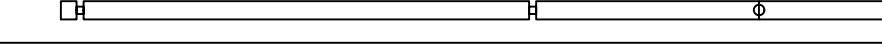
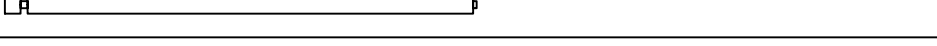
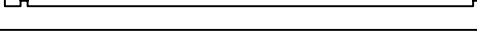
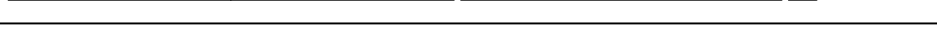
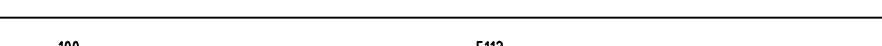
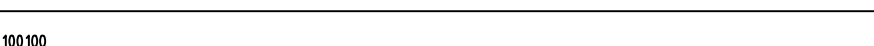
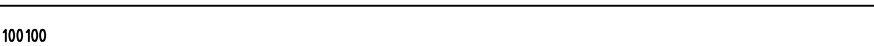



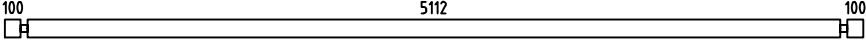
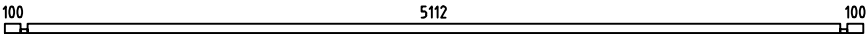
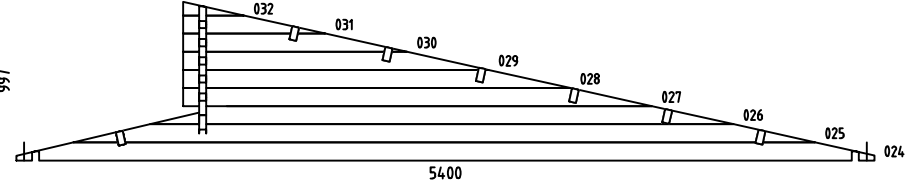
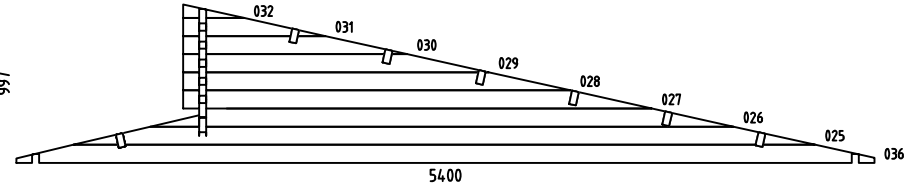
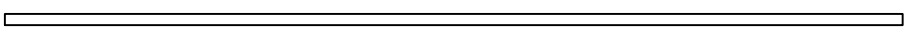
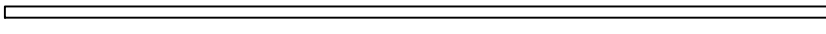
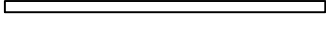

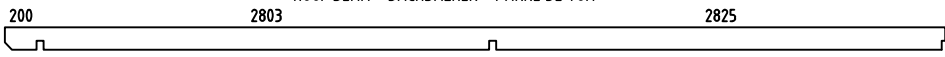
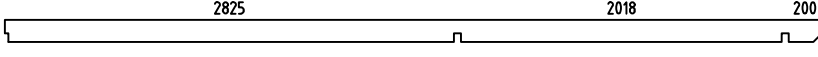
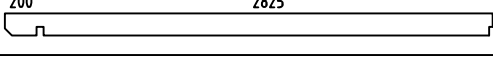
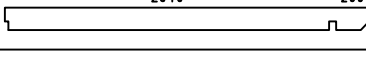





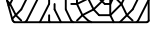





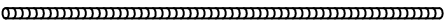



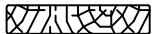

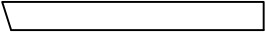
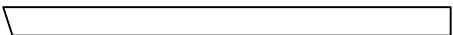
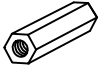



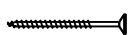

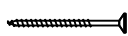

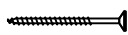





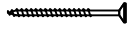

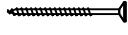

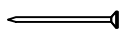

Pos	18.01.2017	Piecelist - Stücklist - Liste des composants Art.Nr. 4410693	10/13	Q.	P. (mm)	L. (mm)
001				18	44x114	346
002				18	44x114	446
003				18	44x114	2408
004				1	44x114	2969
005				10	44x114	5031
006				1	44x120	5916
007				1	44x120	2284
008				1	44x114	3069
009				1	44x114	5131
010				1	44x114	5816
011				11	44x114	2184
012				4	44x114	791
013				4	44x114	1338
014				4	44x114	945
015				4	44x114	398
016				2	44x120	3069
017				1	44x120	5131
018				1	44x114	5816
019				9	44x114	2969
020				9	44x114	5816
021				1	44x120	5131
022				2	44x57	5400
023				38	44x114	5400
033				2	44x57	244
034				34	44x114	244

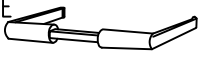
Pos	18.01.2017	Piecelist - Stücklist - Liste des composants Art.Nr. 4410693	11/13	Q.	P. (mm)	L. (mm)
035				21	44x114	5400
037				1	44x57	5400
WA-1 WD-1				1 1		
WB-1 WC-1				1 1		
IAR2		FOUNDATION - FUNDAMENT - FONDATION 		1	45x70	5648
IAR1		FOUNDATION - FUNDAMENT - FONDATION 		3	45x70	5200
IAR3		FOUNDATION - FUNDAMENT - FONDATION 		2	45x70	2017
IAR5		FOUNDATION - FUNDAMENT - FONDATION 		1	45x70	547
IAR4		FOUNDATION - FUNDAMENT - FONDATION 		2	45x70	251
A-PR1		ROOF BEAM - DACHBALKEN - PANNE DE TOIT 		3	44x140	5916
A-PR4		ROOF BEAM - DACHBALKEN - PANNE DE TOIT 		4	44x140	5131
A-PR3		ROOF BEAM - DACHBALKEN - PANNE DE TOIT 		4	44x140	3069
A-PR2		ROOF BEAM - DACHBALKEN - PANNE DE TOIT 		3	44x140	2284
DB1	ROOF BOARDS - DACHBRETTER - VOLIGES			92	90x18	4900
DB2	ROOF BOARDS - DACHBRETTER - VOLIGES			92	90x18	1400
DRV1	ROOF EDGE REINFORCEMENT - DACHRANDVERSTÄRKUNG - CORNIERE DE RENFORT DE BORD DE TOIT			2	44x57	200
DRV2	ROOF EDGE REINFORCEMENT - DACHRANDVERSTÄRKUNG - CORNIERE DE RENFORT DE BORD DE TOIT			1	44x57	2016
DRV3	ROOF EDGE REINFORCEMENT - DACHRANDVERSTÄRKUNG - CORNIERE DE RENFORT DE BORD DE TOIT			2	44x57	2801
DRV4	ROOF EDGE REINFORCEMENT - DACHRANDVERSTÄRKUNG - CORNIERE DE RENFORT DE BORD DE TOIT			2	28x34	4100
GL3	GABLE MOULDING - GIEBELLEISTE - PLANCHE DE RIVE			2	18x120	4100
DPL1	ROOFING FELT FILLET - DACHPAPPENLEISTE - BAGUETTE DE FIXATION DU FEUTRE BITUMEUX			2	18x58	1455

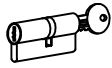
Pos	18.01.2017	Piecelist - Stücklist - Liste des composants Art.Nr. 4410693	12/13	Q.	P. (mm)	L. (mm)
DPL2	ROOFING FELT FILLET - DACHPAPPENLEISTE - BAGUETTE DE FIXATION DU FEUTRE BITUMEUX		4	18x58	4060	
DPL3	ROOFING FELT FILLET - DACHPAPPENLEISTE - BAGUETTE DE FIXATION DU FEUTRE BITUMEUX		2	18x58	4975	
KL1	TREADED ROD M10 - GEWINDESTANGE M10 - - TIGE FILETÉE M10		6		2000	
KL2	TREADED ROD M10 - GEWINDESTANGE M10 - TIGE FILETÉE M10		1		310	
KL3	TREADED ROD M10 - GEWINDESTANGE M10 - TIGE FILETÉE M10		1		260	
KL4	TREADED ROD M10 - GEWINDESTANGE M10 - TIGE FILETÉE M10		4		300	
KL5	TREADED ROD M10 - GEWINDESTANGE M10 - TIGE FILETÉE M10		1		220	
TB	EAVES BOARD - TRAUFBRETT - BANDEAU DE TOIT		4	18x90	4100	
DRV5	ROOF EDGE REINFORCEMENT - DACHRANDVERSTÄRKUNG - CORNIERE DE RENFORT DE BORD DE TOIT		4	28x34	4100	
TP	SUPPORT BEAM FOR GATE FRAME - STUTZBOHLE FÜR TORZARGE - - MADRIER DE SUPPORT DU CADRE DE LA PORTE BASCULANTE		1	44x140	5648	
GL1	GABLE MOULDING - GIEBELLEISTE - - PLANCHE DE RIVE		2	18x120	1500	
GL2	GABLE MOULDING - GIEBELLEISTE - - PLANCHE DE RIVE		2	18x120	4975	
KL4	LENGTHENING BOLT FOR TREADED ROD - VERLÄNGERUNGSMUTTER FÜR GEWINDESTANGE - MANCHON DE RACCORDEMENT DE TIGE FILETÉE		6			
KL1	DRIVE NUT TREADED ROD - EINSCHLAGMUTTER FÜR GEWINDESTANGE - ÉCROU A FRAPPER POUR TIGE FILETÉE		7			
KL2	NUT FOR TREADED ROD - MUTTER FÜR GEWINDESTANGE - ÉCROU POUR TIGE FILETÉE		7			
KL3	PLAIN WASHER TREADED ROD - UNTERLEGSCHIEBE FÜR GEWINDESTANGE - RONDELLE PLATE POUR TIGE FILETÉE		7			
LD1	LID FOR TREADED ROD HOLE - ABDECKUNG FÜR GEWINDESTANGENÖFFNUNG - COUVERCLE POUR ACCÈS RÉGLAGÉ TIGE FILETÉE		1			
HS83	SCREW FOR ROOF EDGE REINFORCEMENT - SCHRAUBEN FÜR DACHRANDVERSTÄRKUNG - VIS POUR RENFORT DE BORD DE TOIT		23	4.5x80		
HS32	SCREW FOR EAVES BOARDS - SCHRAUBEN FÜR TRAUFBRETT - VIS DE FIXATION POUR BANDEAU DE TOIT		54	4x40		
HS26	SCREW FOR ROOF EDGE REINFORCEMENT - SCHRAUBEN FÜR DACHRANDVERSTÄRKUNG - VIS POUR RENFORT DE BORD DE TOIT		54	4x40		
HS43	SCREW FOR ROOF BEAMS - SCHRAUBEN FÜR DACHBALKEN - VIS POUR PANNE DE TOIT		35	5x120		
HS42	SCREW FOR GABLE - SCHRAUBEN FÜR GIEBEL - VIS POUR FIXATION DES PIGNONS		48	5x120		
HS40	SCREW FOR 1. WALL BEAM - SCHRAUBE FÜR 1. BOHLENREIHE - VIS DE FIXATION DES FONDATIONS		14	5x90		
HS39	SCREW FOR FUNDAMENT - SCHRAUBEN ZUR BEFESTIGUNG FUNDAMENT - VIS POUR FONDATION		8	5x90		
	SCREW FOR 1. WALL BEAM - SCHRAUBE FÜR 1. BOHLENREIHE - VIS DE FIXATION DES FONDATIONS		3	6x150		

Pos	18.01.2017	Piecelist - Stücklist - Liste des composants Art.Nr. 4410693	13/13	Q.	P. (mm)	L. (mm)
HS44	SCREW FOR GABLE - SCHRAUBEN FÜR GIEBEL - VIS POUR FIXATION DES PIGNONS		17	6x180		
	SCREW FOR GABLE MOULDING - SCHRAUBEN FÜR GIEBELLEISTE - VIS DE FIXATION POUR PLANCHE DE RIVE		66	3.5x50		
MC	METAL CORNER - METALLWINKEL - CORNIERE EN MÉTAL		2	40x40		
	SCREW FOR METAL CORNER - HOLZSCHRAUBE FÜR METALLWINKEL - VIS POUR COIN EN MÉTAL		16	4x40		
HS51	SCREW FOR BEAM HOLDER - SCHRAUBEN FÜR BALKENHALTER - VIS DE FIXATION SUPPORT U GALVANISÉ		216	5x40		
SH44	HAMMER BLOCK - SCHLAGHOLZ - CALLE DE FRAPPE		1			
MS	SCREW FOR DOORSTEP - SCHRAUBEN FÜR SWELLE - VIS DE FIXATION DU SEUIL DE PORTE		2	4.5x65		
	ZN NAIL FOR ROOF - ZN NÄGEL FÜR DACHBRETTTER - POINTES DE FIXATIONS DES VOLIGES DE TOIT		1023	2x50		
	ZN NAIL FOR ROOFING FELT FILLET - ZN NÄGEL FÜR DACHPAPPENLEISTE - POINTE POUR BAGUETTE FIXATION FEUTRE BITUMEUX		66	2x40		
BH	BEAM HOLDER - BALKENHALTER - SUPPORT EN U GALVANISÉ		18	45x97		
TS3	DOOR HANDLE FITTINGS - TÜRGRIF - SET DE GARNITURES DE SERRURE DE PORTE		1			
TS4	SET OF DOOR LOCK COVERS - SCHLOSSBLENDEN - SET DE GARNITURES DE SERRURE DE PORTE		1			
TS6	CYLINDER LOCK - ZYLINDERSCHLOSS - CYLINDRE DE SERRURE		1	30x35		
	WINDOW - FENSTER - FENETRE 1500x410	AK.1.100.SM0.k SGC	3			
						
	DOOR - TÜR - PORTE 835x1850	UL.2.100.IVP.MMa TC	1			
	