

Faro 3
Art. Nr. 290600
1/9

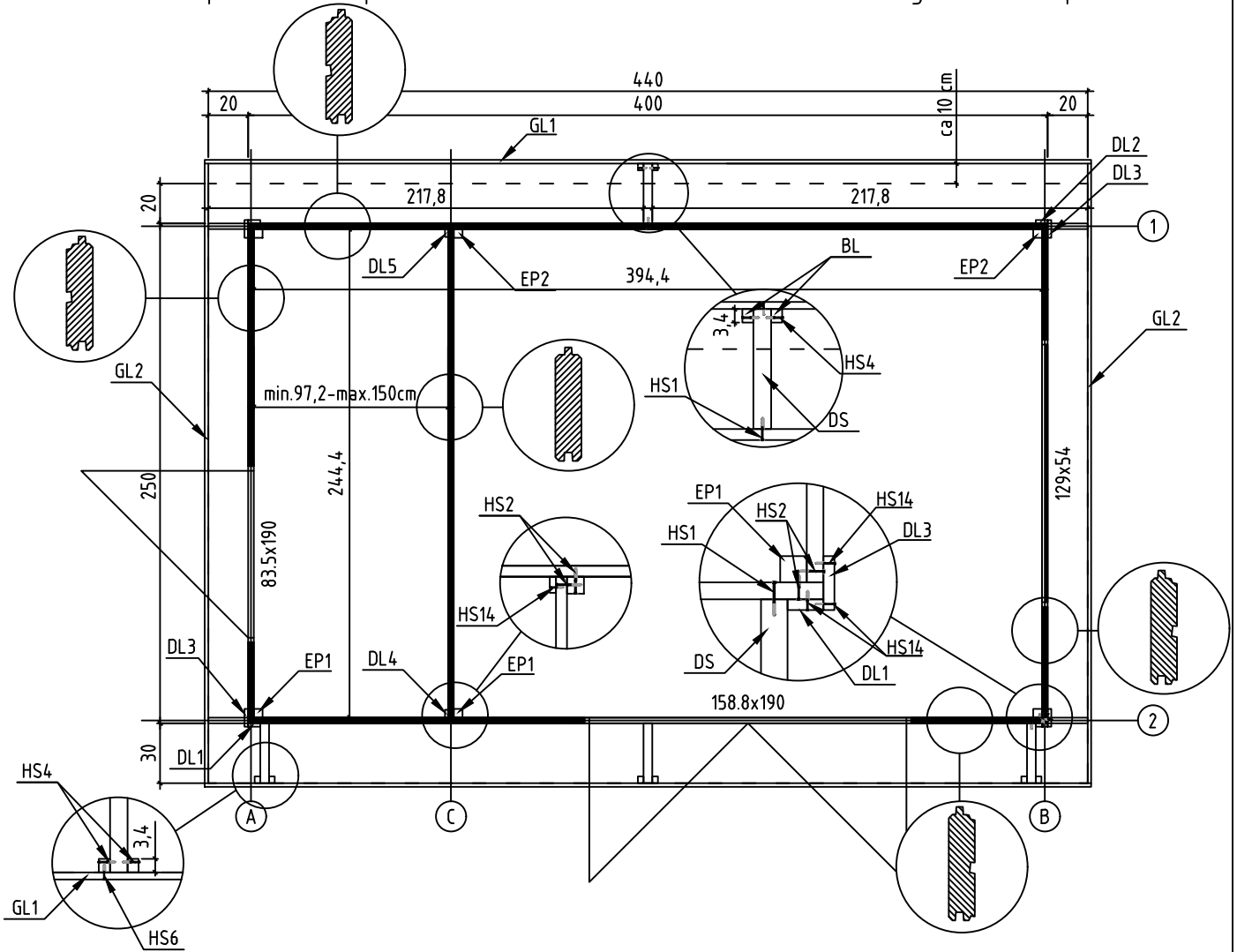

19.02.2018

Groundplan - Grundplan - Plan de masse - Planimetria - Plattegrond - Põhiplaan



Foundation - Fundament - Fondation - Fondamenta - Fundering - Immutatud alusraam

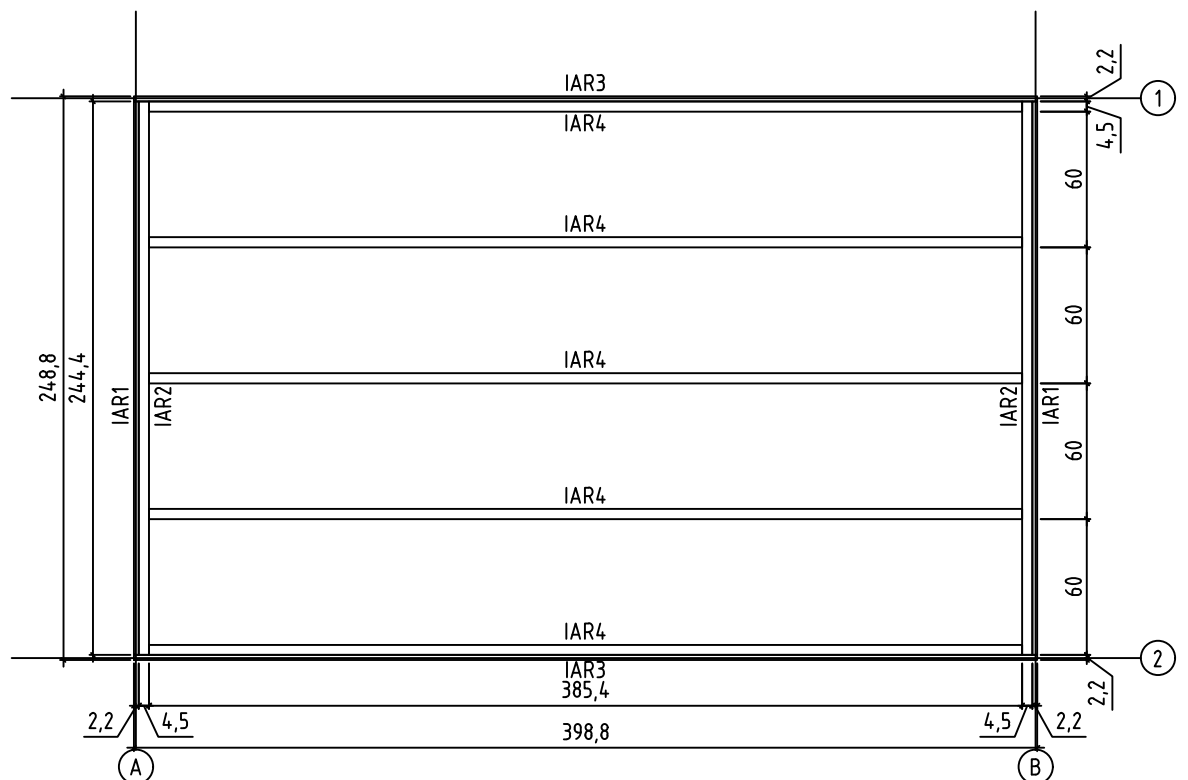

Floor boards - Fussbodenbretter - Plan pose plancher - Pavimento - Vloerhout - Põrandalaudis

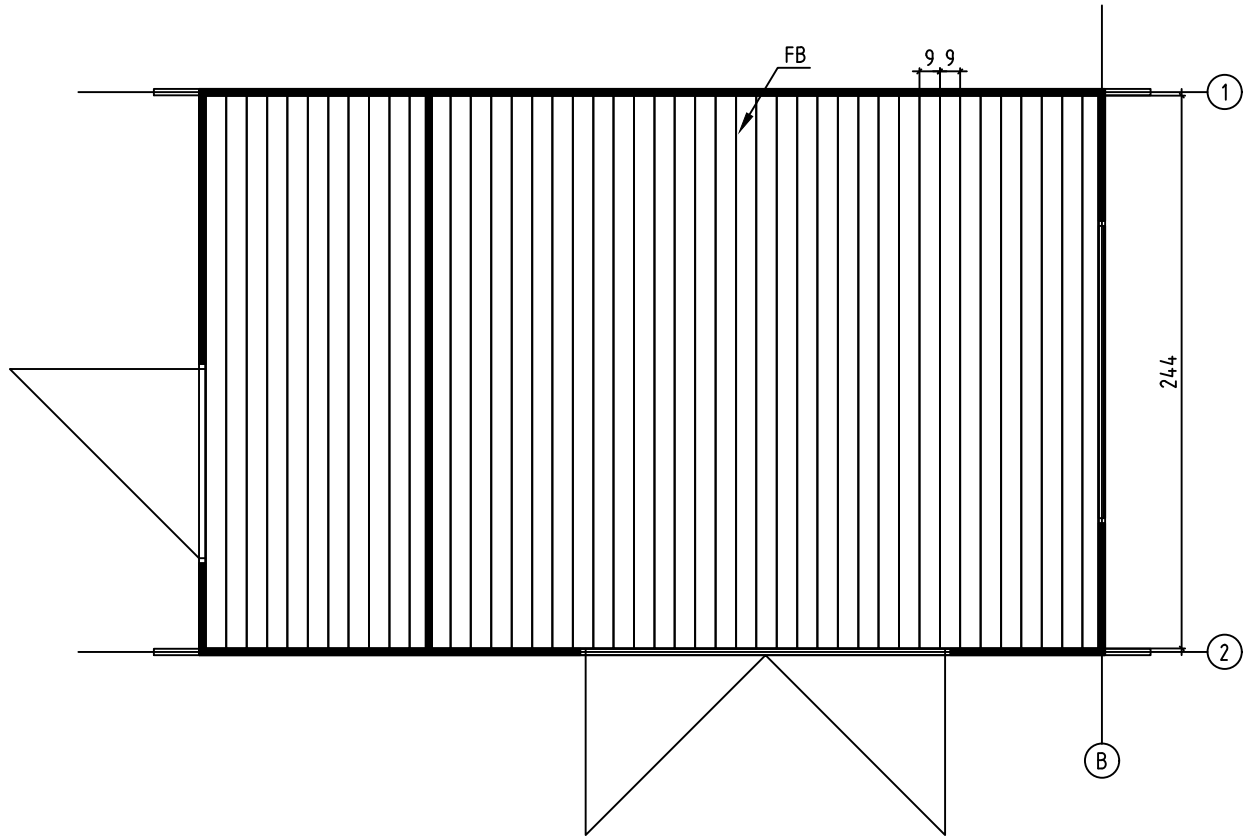



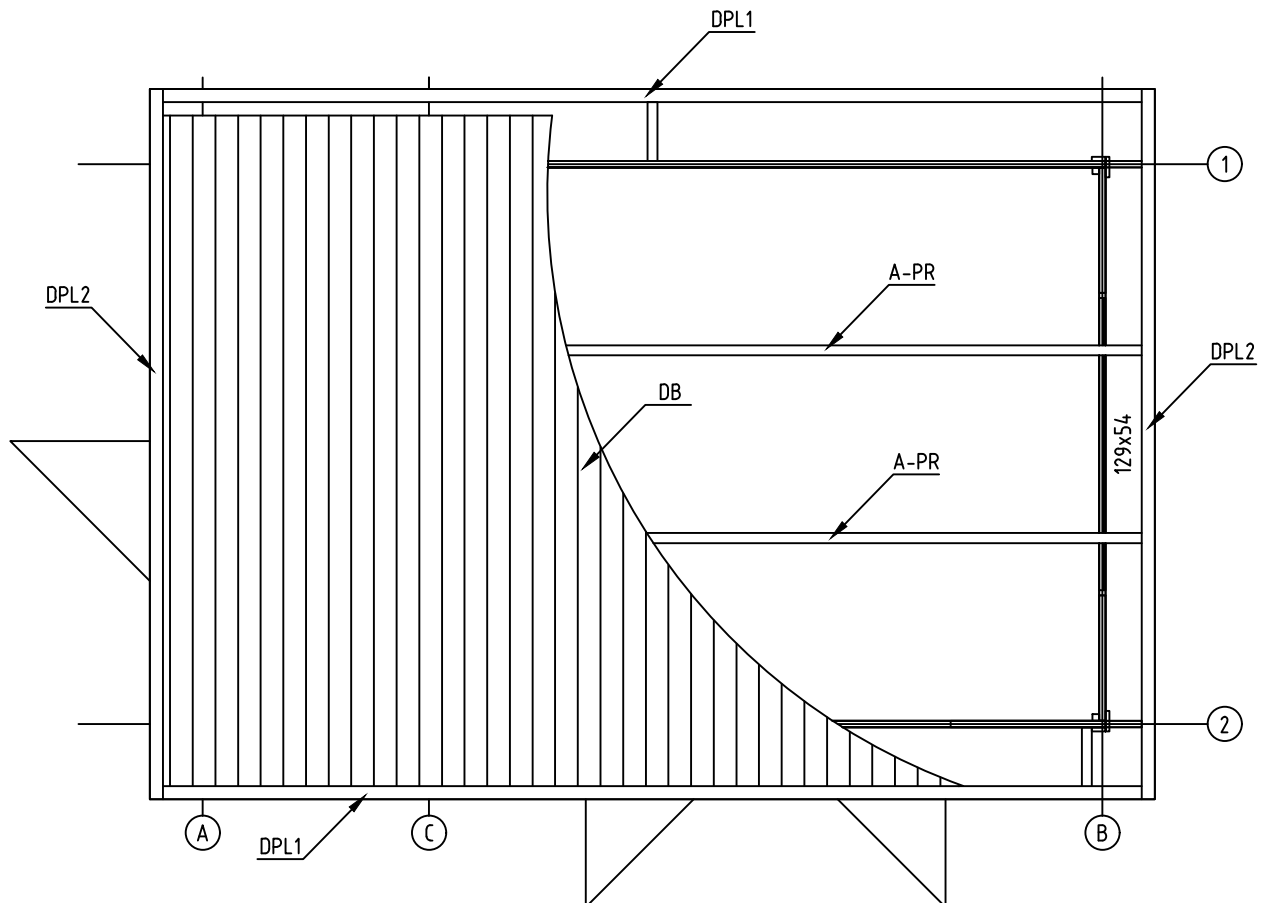

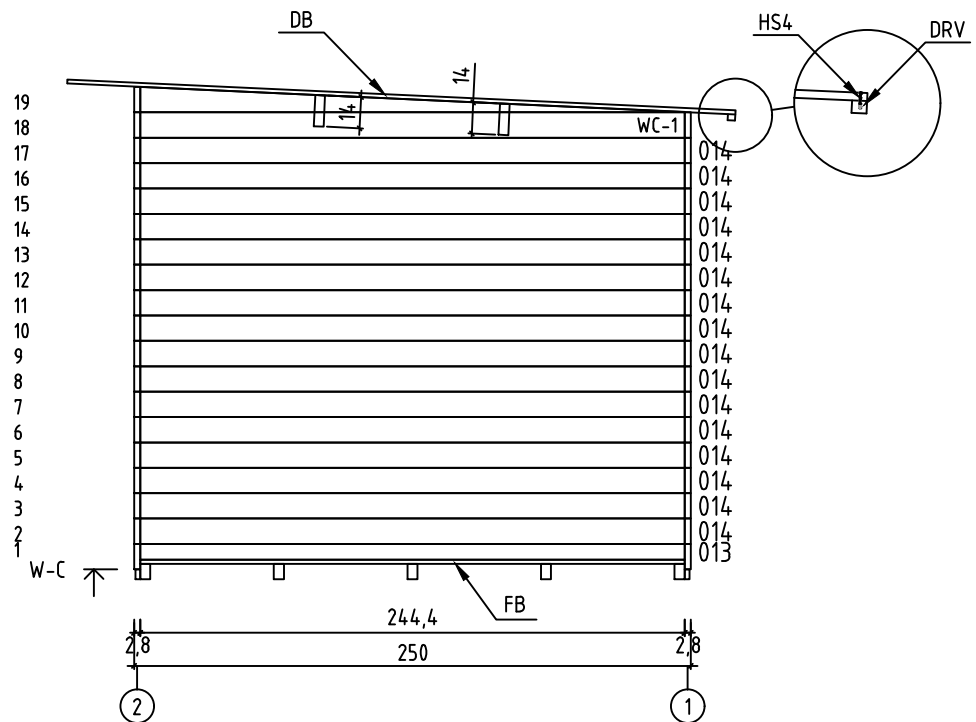
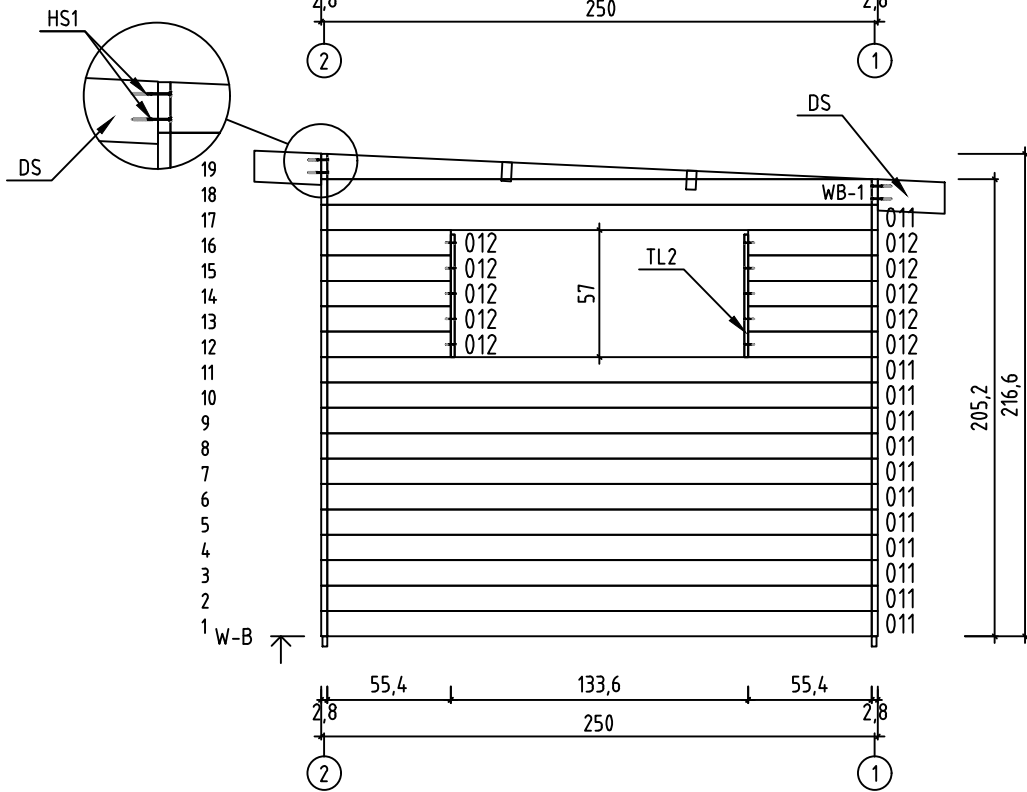
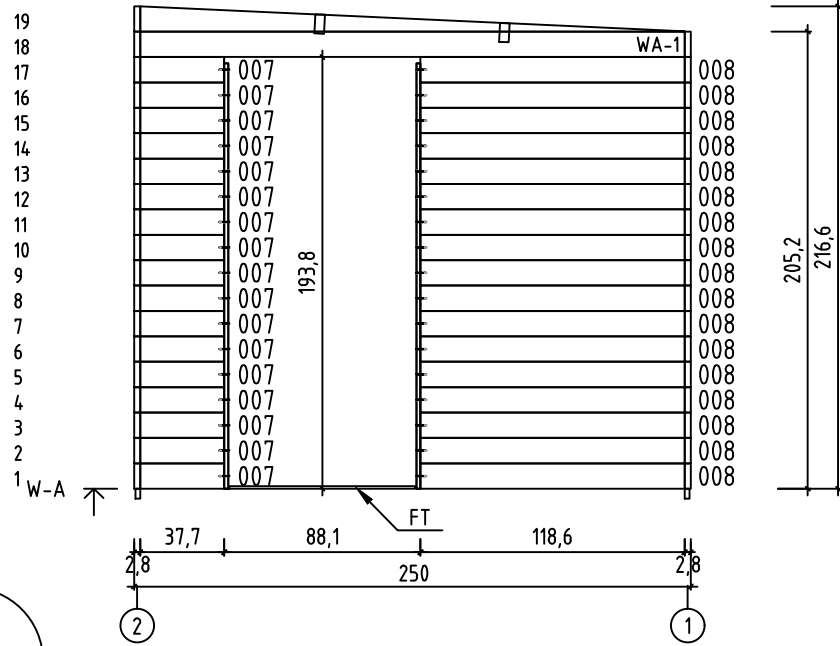

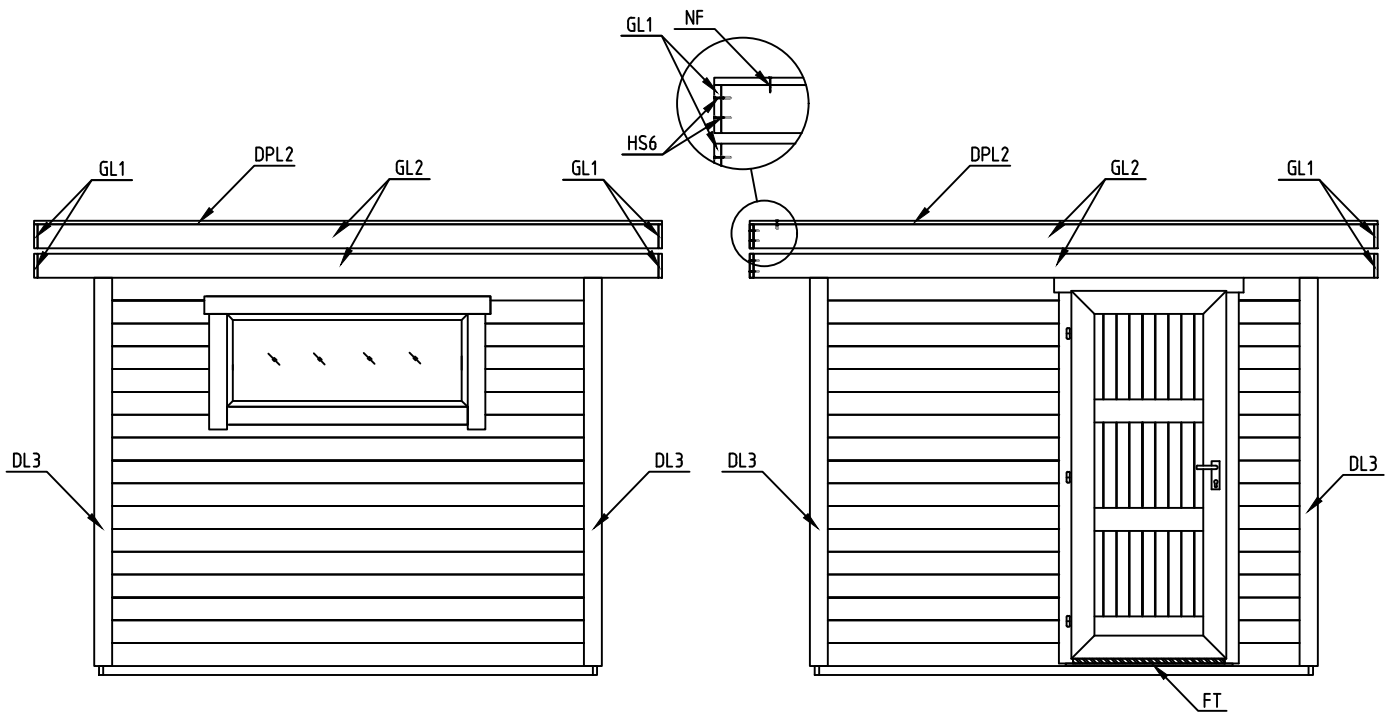
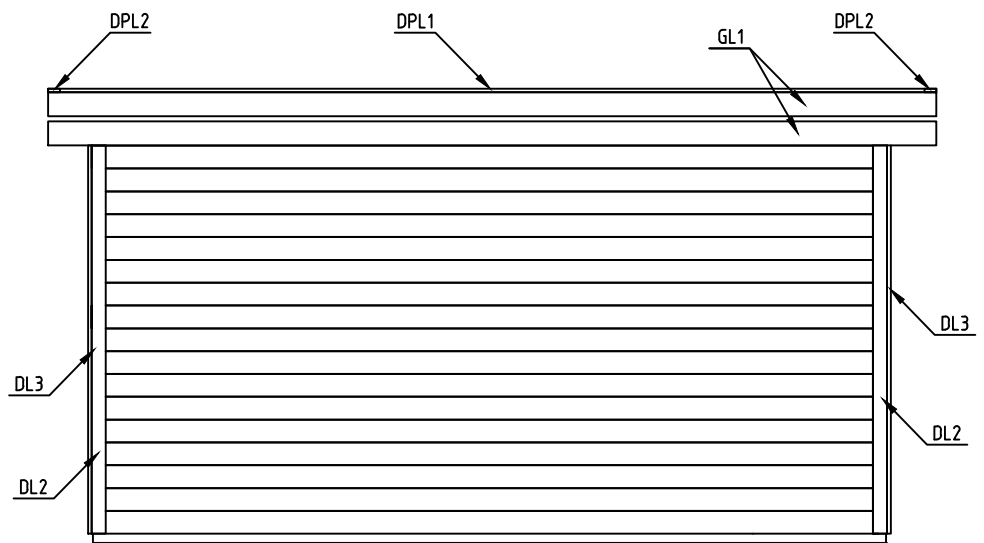
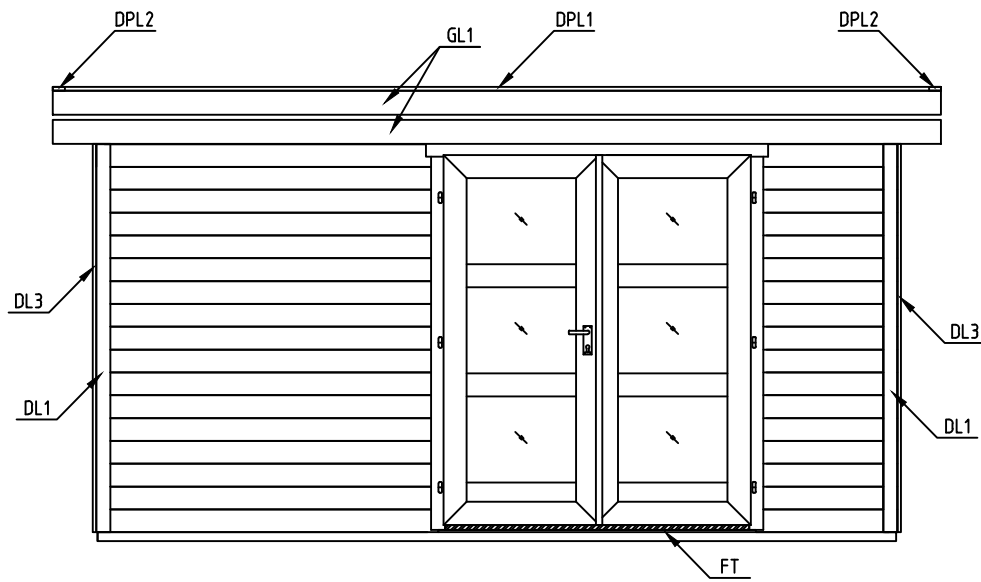











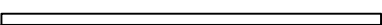
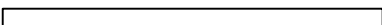

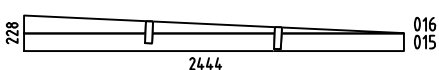
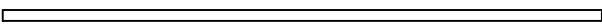
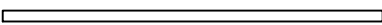
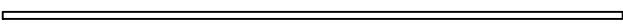
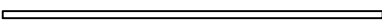
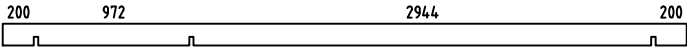











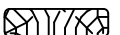
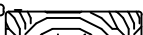

Roof plan - Dach-plan - Plan du toit - Piano del tetto - Dak plattegrond - Katuseplaan









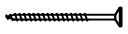
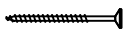
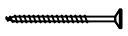

| Pos | 19.02.2018 Piece list - Stückliste - Liste des pièces - Elementi - Stuklijst - Tükitalabel Art.nr. 290600 | 7/9 | Q | P (mm) | L (mm) |
|-------|---|-----|----|-----------|-----------|
| 001 |  | | 17 | 28x114 | 4000 |
| 002 |  | | 1 | 28x114 | 4400 |
| 003 |  | | 17 | 28x114 | 1683 |
| 004 |  | | 17 | 28x114 | 683 |
| 005 |  | | 1 | 28x114 | 4400 |
| 006 |  | | 1 | 28x114 | 4400 |
| 007 |  | | 17 | 28x114 | 377 |
| 008 |  | | 17 | 28x114 | 1186 |
| 011 |  | | 12 | 28x114 | 2444 |
| 012 |  | | 10 | 28x114 | 554 |
| 013 |  | | 1 | 28x71 | 2444 |
| 014 |  | | 16 | 28x114 | 2444 |
| WA-1 |  | | 1 | | |
| WB-1 |  | | 1 | | |
| WC-1 |  | | 1 | | |
| IAR4 | Foundation - Fundament - Fondation - Fondamenta - Fundering - Immutatud alusraam  | | 5 | 45x70 | 3854 |
| IAR2 | Foundation - Fundament - Fondation - Fondamenta - Fundering - Immutatud alusraam  | | 2 | 45x70 | 2444 |
| IAR3 | Foundation - Fundament - Fondation - Fondamenta - Fundering - Immutatud alusraam  | | 2 | 22x45 | 3988 |
| IAR1 | Foundation - Fundament - Fondation - Fondamenta - Fundering - Immutatud alusraam  | | 2 | 22x45 | 2444 |
| A-PR1 | Roof beam - Dachbalken - Panne de toit - Perlina del tetto - Gordingen / dakbalk - Pärtin  | | 2 | 44x140 | 4400 |
| FB | Floor boards - Fussbodenbretter - Lame de plancher - Pavimento - Vloerhout - Põrandalaud  | | 44 | 90x18 | 2440 |
| DB | Roof boards - Dachbretter - Voliges - Perlina per tetto - Dakhout - Katuselaud  | | 49 | 90x18 | 2988 |
| | Floor fillet - Fussbodenleiste - Corniere de finition du plancher - Finitura per pavimento (battisco pa) - Vloerafwerklijst - Põrandaliist  | | | 18x18 | 12.76 |



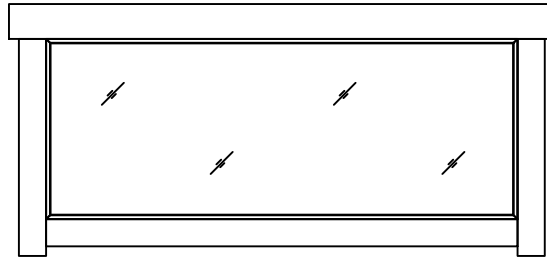

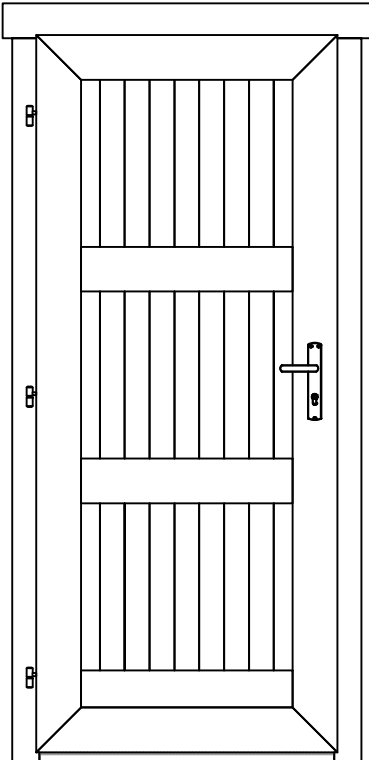
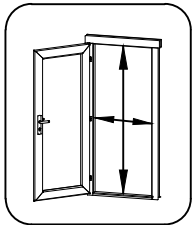

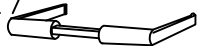
| Pos | 19.02.2018 Piece list - Stückliste - Liste des pièces - Elementi - Stuklijst - Tükítabel Art.nr. 290600 | 8/9 | Q | P (mm) | L (mm) |
|------|---|-----|----|-----------|-----------|
| DL5 | Batten - Deckleiste - Profils de finition angles a l'exterieur - Asse - Afdek lijst - Katteliist  | | 1 | 15x40 | 1970 |
| DL4 | Batten - Deckleiste - Profils de finition angles a l'exterieur - Asse - Afdek lijst - Katteliist  | | 1 | 15x40 | 2085 |
| DPL2 | Roofing felt fillet - Dachpappenleiste - Baguette de fixation du feutre bitumeux - Asse per fissaggio guaina bituminosa - Afdeklijst asfaltpapier - Katusepapiliist  | | 2 | 18x58 | 3136 |
| DPL1 | Roofing felt fillet - Dachpappenleiste - Baguette de fixation du feutre bitumeux - Asse per fissaggio guaina bituminosa - Afdeklijst asfaltpapier - Katusepapiliist  | | 2 | 18x58 | 4320 |
| FT | Fillet - Leiste - Lattes - Massellino di guarnizione per ringhiera - Lijst - Liist lävepaku alla  | | 1 | 12x22 | 835 |
| FT | Fillet - Leiste - Lattes - Massellino di guarnizione per ringhiera - Lijst - Liist lävepaku alla  | | 1 | 12x22 | 1588 |
| DL2 | Corner fillet - Deckleiste - Profils de finition angles a l'exterieur - Massello d'angolo - (hoek)lijst - Nurgaliist  | | 2 | 18x70 | 2052 |
| DL1 | Corner fillet - Deckleiste - Profils de finition angles a l'exterieur - Massello d'angolo - (hoek)lijst - Nurgaliist  | | 2 | 18x70 | 2166 |
| DL3 | Corner fillet - Deckleiste - Profils de finition angles a l'exterieur - Massello d'angolo - (hoek)lijst - Nurgaliist  | | 4 | 18x90 | 1938 |
| EP2 | Corner stud - Eckpfosten - Poteaux d'angle pour fixation des madriers - Perno angolare - Hoek staander (kolom) - Nurgapost  | | 3 | 44x44 | 1970 |
| EP1 | Corner stud - Eckpfosten - Poteaux d'angle pour fixation des madriers - Perno angolare - Hoek staander (kolom) - Nurgapost  | | 3 | 44x44 | 2085 |
| DRV | Roof edge reinforcement - Dachrandverstärkung - Corniere de renfort de bord de toit - Rinforzo x tetto - Dakrand versterking - Räästatugevdus  | | 2 | 28x34 | 2177 |
| TL2 | Fixing fillet - Fixierungsleiste - Profil de fixation - Massello di fissaggio - Bevestiging lijstwerk - Tenderliist  | | 2 | 18x28 | 550 |
| TL1 | Fixing fillet - Fixierungsleiste - Profil de fixation - Massello di fissaggio - Bevestiging lijstwerk - Tenderliist  | | 4 | 18x28 | 1910 |
| DS | Fixing slat for distance spacers - Befestigungsteile - Renforts planches de rives - Stecca per fissare i distanziatori - Bevestigingslat afstandhouders - Viilulaua kinnitus  | | 8 | 28x34 | 230 |
| BL | Distance spacers for gable moulding - Dachstützen - Supports extension toiture - Distanziatori per la modanatura del timpano - Daksteun / afstand houder - Viilulaua tugiklots  | | 4 | 44x140 | 307 |
| GL2 | Gable moulding - Giebelleiste - Planche de rive - Finitura per frontale e retro del tetto - Gevellijst - Viilulaud  | | 4 | 18x120 | 3100 |
| GL1 | Gable moulding - Giebelleiste - Planche de rive - Finitura per frontale e retro del tetto - Gevellijst - Viilulaud  | | 4 | 18x120 | 4436 |
| HS6 | Screw for gable moulding - Schrauben für giebelleiste - Vis pour fixation planche de rive - Vite per fissare finiture davanti e dietro del tetto - Schroef voor gevellijst - Kruvi viilulauale  | | 68 | 3.5x50 | |
| HS14 | Screw for corner batten - Schrauben für deckleisten - Vis de fixation profils de finition angles a l'exterieur - Viti per stecca d'angolo - Schroef voor afdeklát - Kruvi nurgaliistule  | | 56 | 3.5x35 | |
| HS4 | Screw for roof edge reinforcement - Schrauben für dachrandverstärkung - Vis pour fixation corniere renfort de bord de toit - Viti x rinforzo bordo tetto - Schroef voor dakrand versterking - Kruvi räästatugevdusele  | | 14 | 4x40 | |
| HS4 | Screw for fixing fillet of door and window - Schrauben für fixierungsleiste - Vis pour profil vertical de fixation pour ouvertures des fenetres et portes - Viti per massello di fissaggio - Schroeven voor bevestiging van deur en raam lijsten - Kruvi tenderliistudele  | | 78 | 4x40 | |
| HS4 | Screw for distance spacer fixing slat - Schrauben für befestigungsleiste - Vis de fixation renforts planches de rives - Viti per distanziatore della stecca di fissaggio - Schroef voor afstand houder lat - Kruvi viilulaua kinnitusele  | | 16 | 4x40 | |

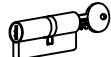
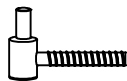
| | | | | | |
|-----|--|-----|---|-----------|-----------|
| Pos | 17.11.2017 Piece list - Stückliste - Liste des pièces - Elementi - Stuklijst - Tükítabel 1290x540 AK.1.100.TSM0.c SGC | 1/1 | Q | P (mm) | L (mm) |
|-----|--|-----|---|-----------|-----------|

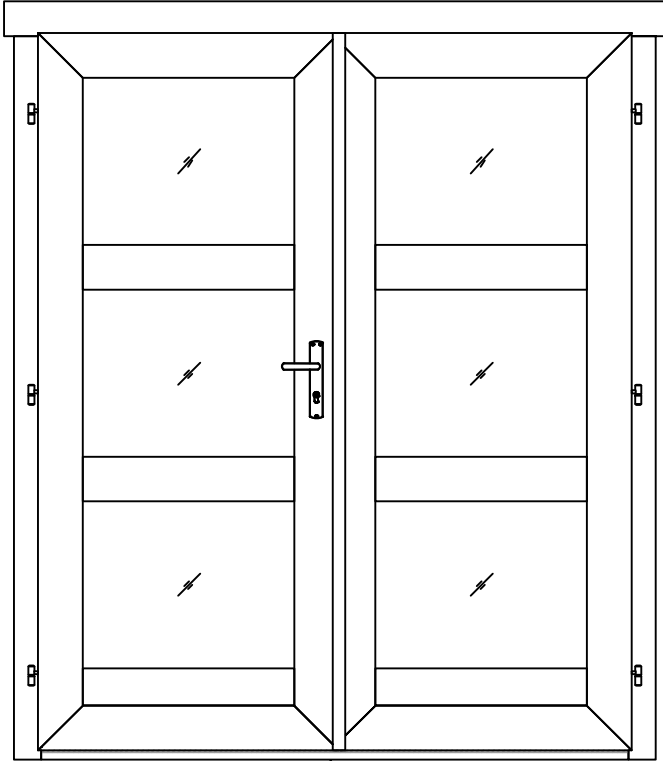
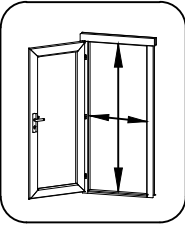
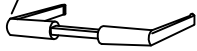
Glass size - Glasgröße - Taille de la vitre - Misura del vetro - Glas afmeting - Klaasi mõõt: 1210x460 mm

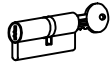
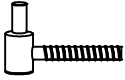

| Pos | 04.04.2017 | Piece list - Stückliste - Liste des pièces - Elementi - Stuklijst - Tükitalabel 835x1900 UL.3.030.IVV.MMTb TC | 1/1 | Q | P (mm) | L (mm) |
|------|--|--|-----|--------|-----------|-----------|
| | |   <p>735x1818 mm</p> | | | | |
| HS25 | Screw for doorstep - Schrauben für swelle - Vis pour fixation barre de seuil - Vite per soglia della porta - Schroef voor deurdorpel - Kruvi lävepakule |  | 2 | 4.5x65 | | |
| HS16 | Screw for door jamb - Schraube für türrahmen - Vis de fixation partie haute avec montants du cadre de porte - Viti x fissaggio montanti porte - Schroef voor deurkozijn - Kruvi ukse lengile |  | 4 | 5x90 | | |
| TL4 | Door handle fittings - Türgriff - Poignée de porte - Maniglie - Deurhendel / klink - Ukse käepide |  | 1 | | | |
| TL5 | Set of door lock covers - Schlossblenden - Set de garnitures de porte - Copertura serrature - Slot sluitplaat set - Ukse lukuplaat |  | 1 | | | |
| | Cylinder lock - Zylinderschloss - Barillet de porte - Serratura - Cylinder slot - Ukse lukusüdamik |  | 1 | 30x35 | | |
| | Male bolt hinge for door - Türband - Partie male de paumelle de porte - Cerniera anube x porta - Scharnier bout - Ukse polthing isane |  | 3 | | | |

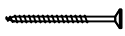
| Pos | 17.11.2017 | Piece list - Stückliste - Liste des pièces - Elementi - Stuklijst - Tükitalabel 1588x1900 TUK.3.030.TSVV.MMTb SGC | 1/1 | Q | P (mm) | L (mm) |
|------|--|--|-----|--------|-----------|-----------|
| | | Glass size - Glasgröße - Taille de la vitre - Misura del vetro - Glas afmeting - Klaasi mõõt: 561x446 mm | | | | |
| | |   <p>1488x1816 mm</p> | | | | |
| TL4 | Door handle fittings - Türgriff - Poignée de porte - Maniglie - Deurhendel / klink - Ukse käepide |  | 1 | | | |
| TL5 | Set of door lock covers - Schlossblenden - Set de garnitures de porte - Copertura serrature - Slot sluitplaat set - Ukse lukuplaat |  | 1 | | | |
| | Cylinder lock - Zylinderschloss - Barillet de porte - Serratura - Cylinder slot - Ukse lukusüdamik |  | 1 | 30x35 | | |
| | Male bolt hinge for door - Türband - Partie male de paumelle de porte - Cerniera anube x porta - Scharnier bout - Ukse polthing isane |  | 6 | | | |
| | Striker for barrel bolt - Hülse für grendelriegel - Gache au sol du targette - Boccola per fermo della porta - Huls voor vergrendelingsschuif - Vasturaud ukse servariivile |  | 2 | | | |
| HS4 | Screw for door fillet - Schraube zur befestigung türleiste - Vis pour fixation baguette d'arret de porte - Viti per massellino della porta - Schroef voor deurlijst - Kruvi ukse kokkuvaltšiliistule |  | 5 | 3x30 | | |
| HS16 | Screw for door jamb - Schraube für türrahmen - Vis de fixation partie haute avec montants du cadre de porte - Viti x fissaggio montanti porte - Schroef voor deurkozijn - Kruvi ukse lengile |  | 4 | 5x90 | | |
| HS25 | Screw for doorstep - Schrauben für swelle - Vis pour fixation barre de seuil - Vite per soglia della porta - Schroef voor deurdorpel - Kruvi lävepakule |  | 3 | 4.5x65 | | |

GENERAL INSTALLATION INSTRUCTIONS- ALLGEMEINE AUFBAUANLEITUNG- CONSIGNES GÉNÉRALES DE MONTAGE- ISTRUZIONI PER L'ASSEMBLAGGIO- ALGEMENE OPBOUWHANDLEIDING- ÜLDINE PÜSTITUSJUHEND

