

Exeter 1
Art.No. 7012202

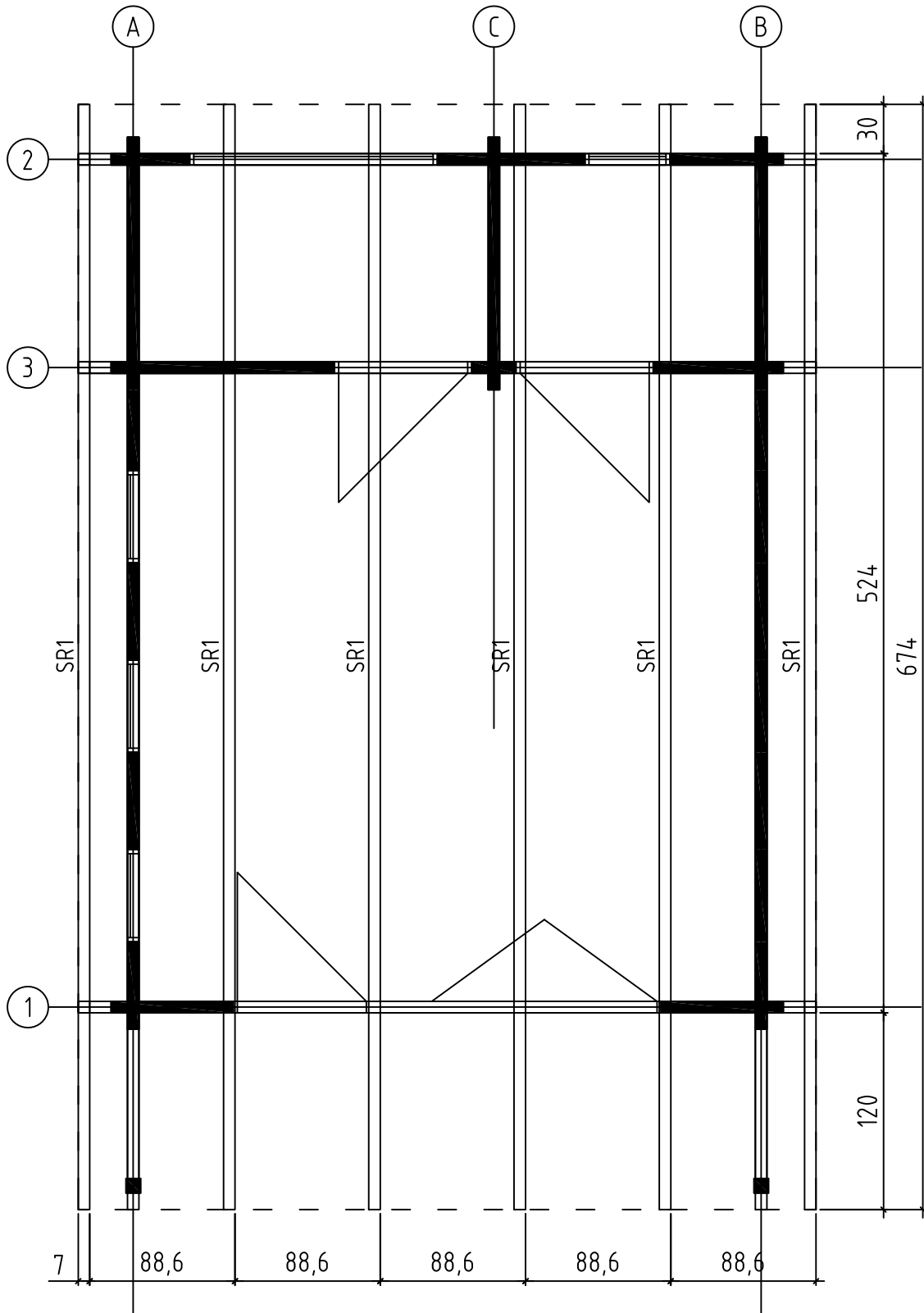

Exeter 1 - Art.No.7012202
RAFTERS PLAN - DACHSPARREN - PLAN DE CHEVRON



Exeter 1 - Art.No.7012202
FLOOR BOARDS - FUSSBODENBRETTER - PLAN POSE PLANCHER

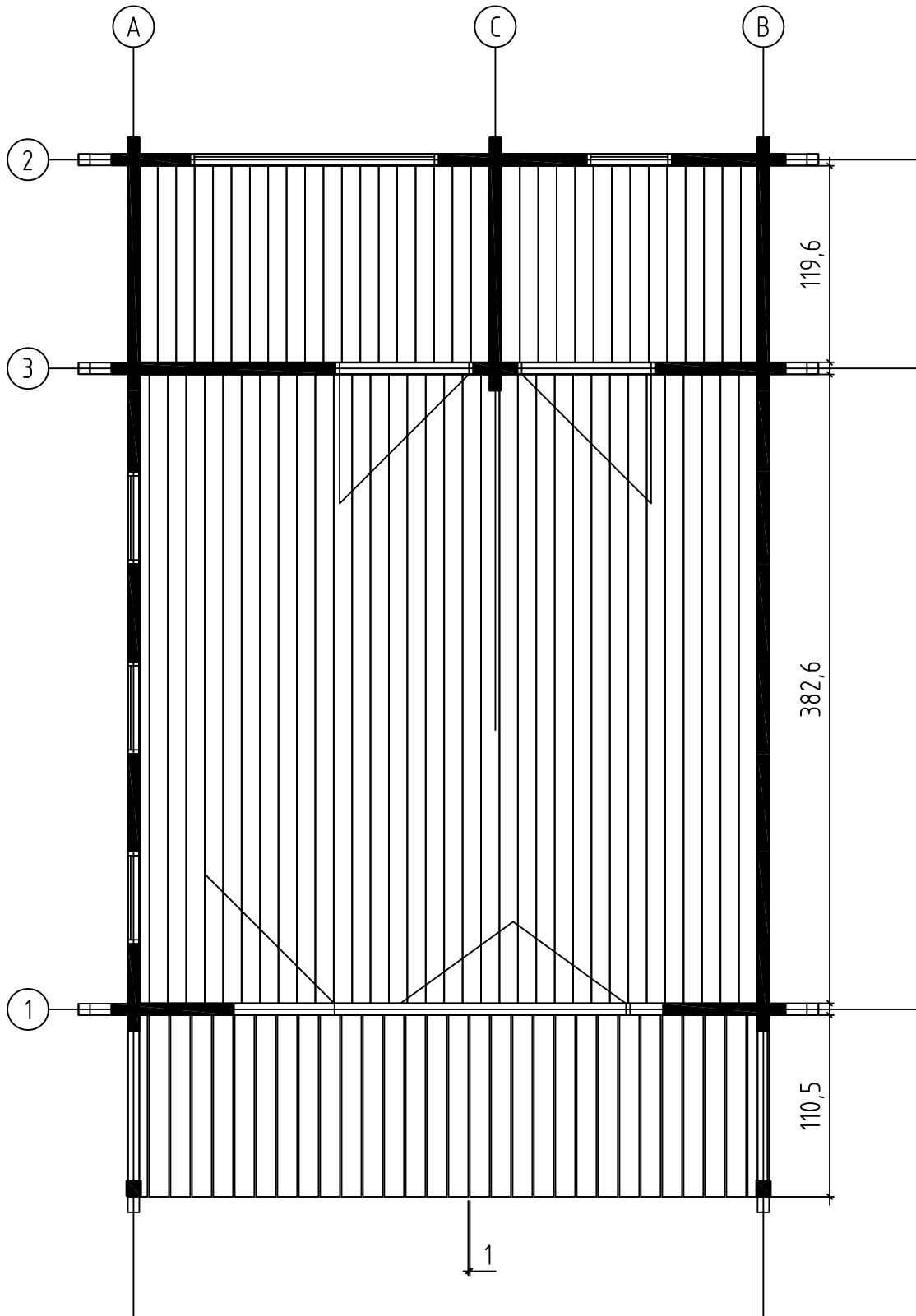

Exeter 1 - Art.No.7012202

450

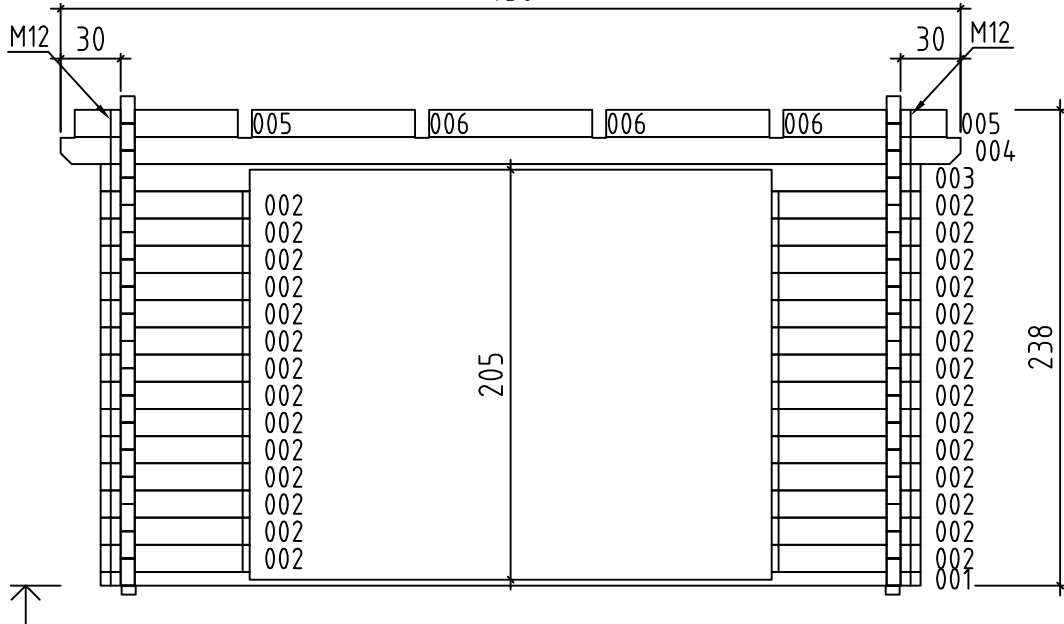

Wall-Wand-Mur 1

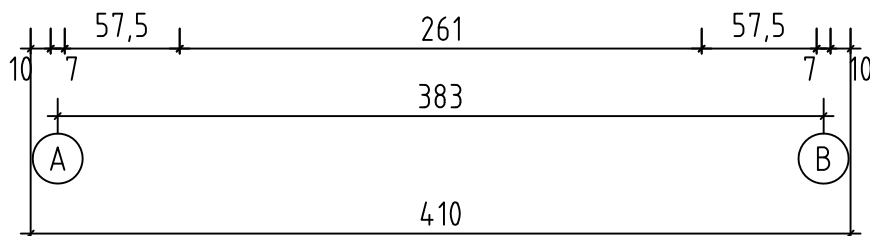

450

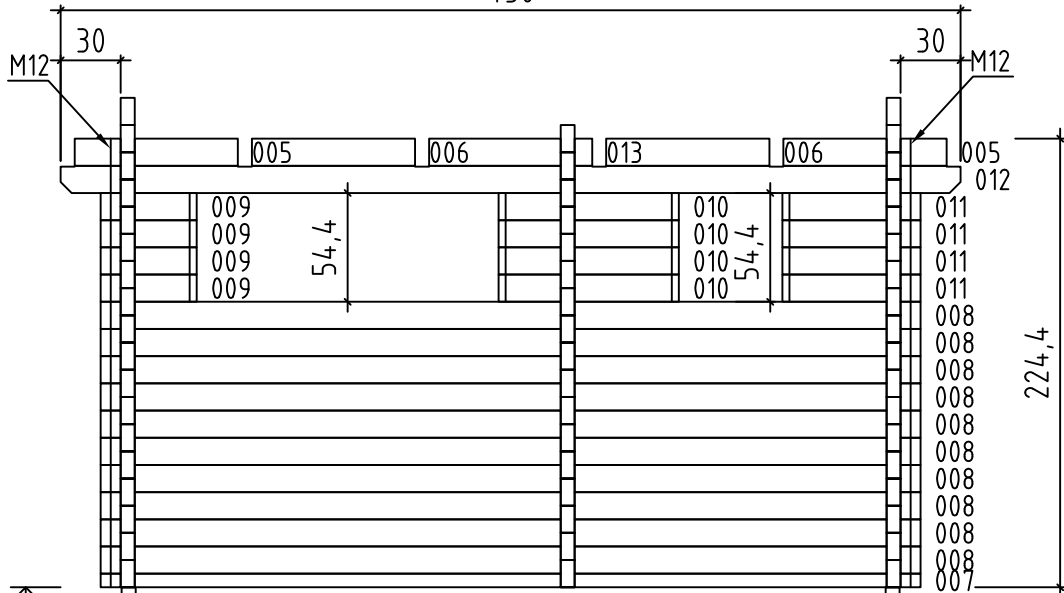



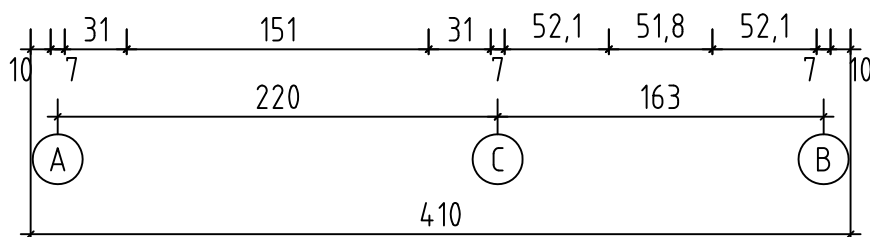

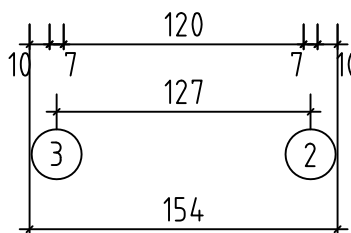
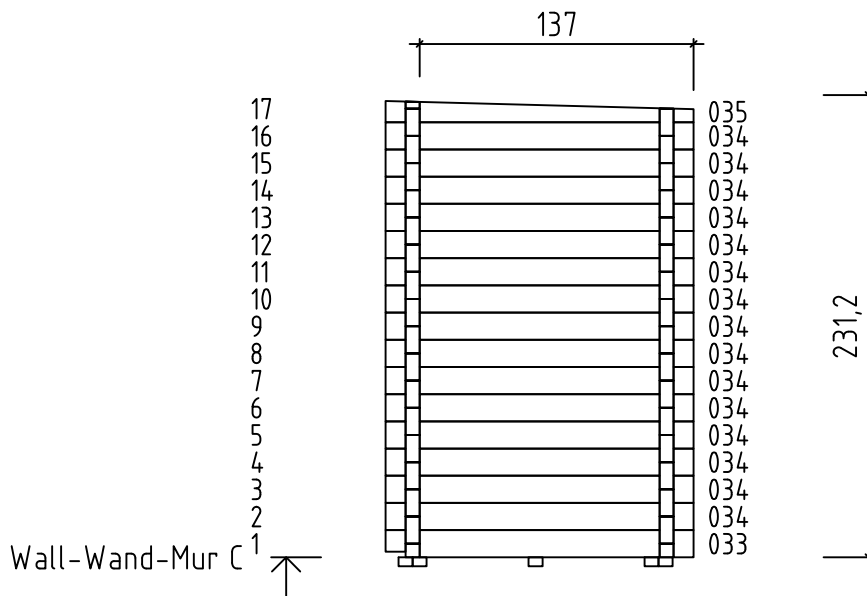
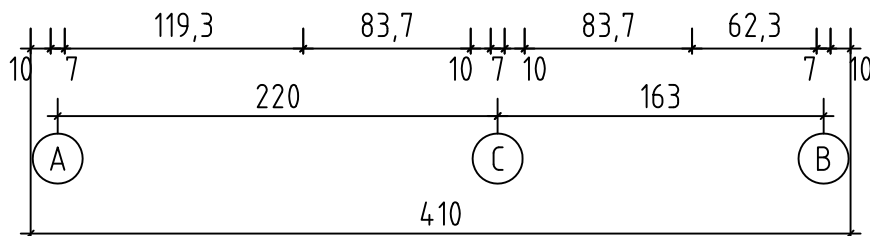
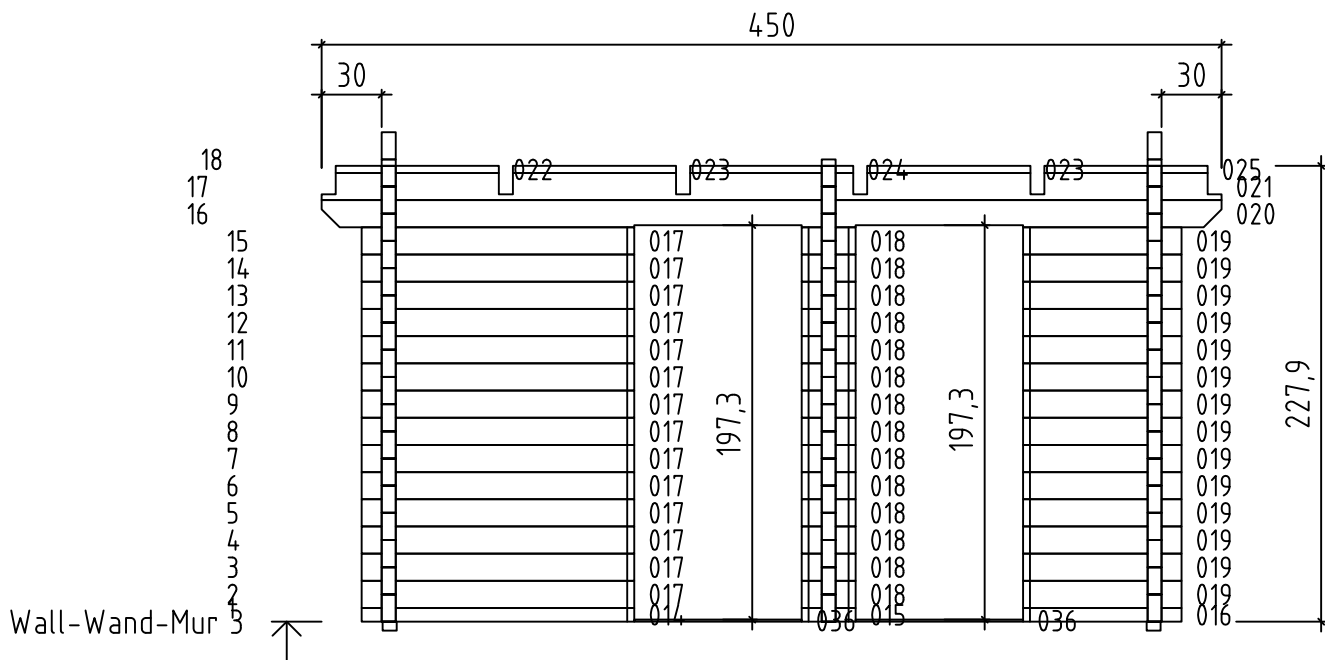

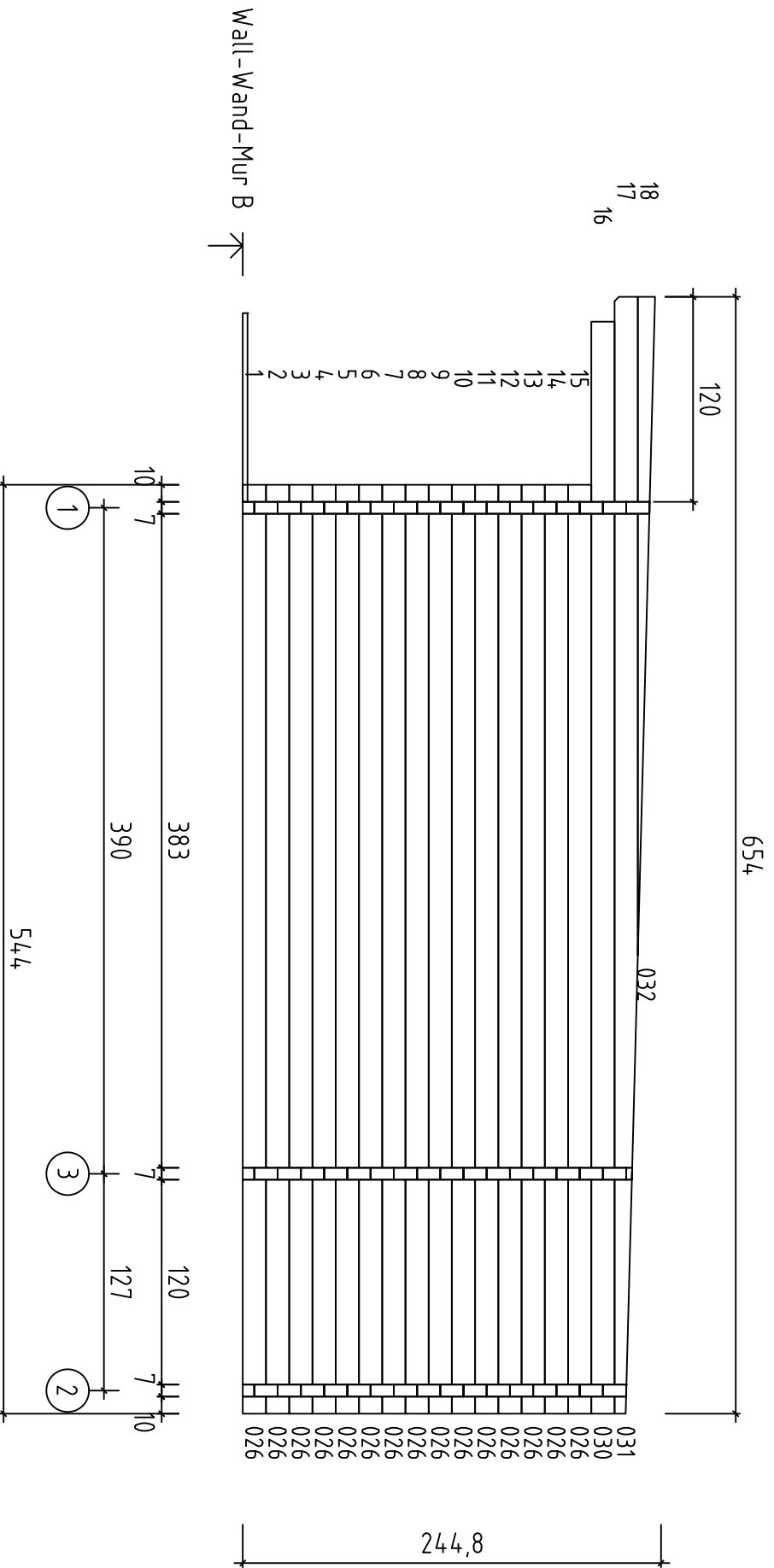
Wall-Wand-Mur 2

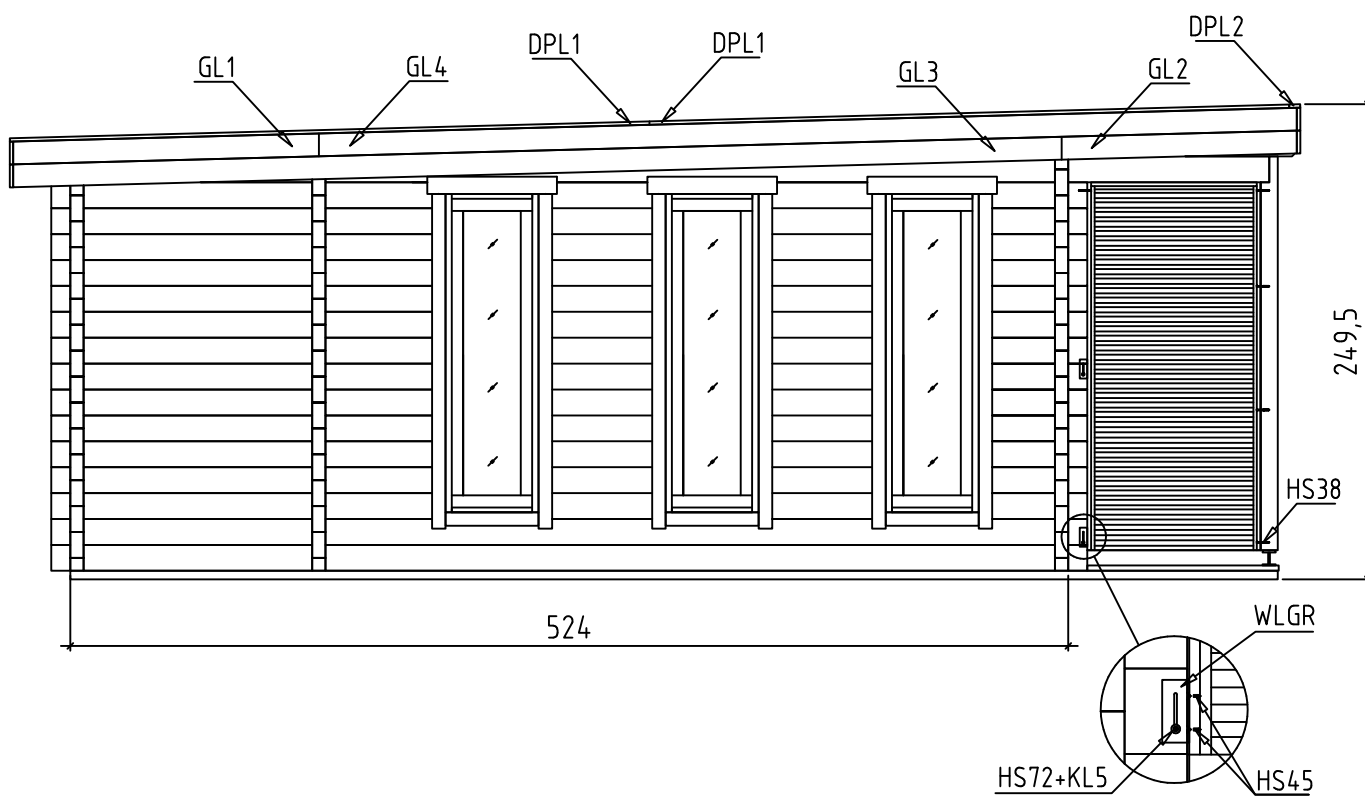
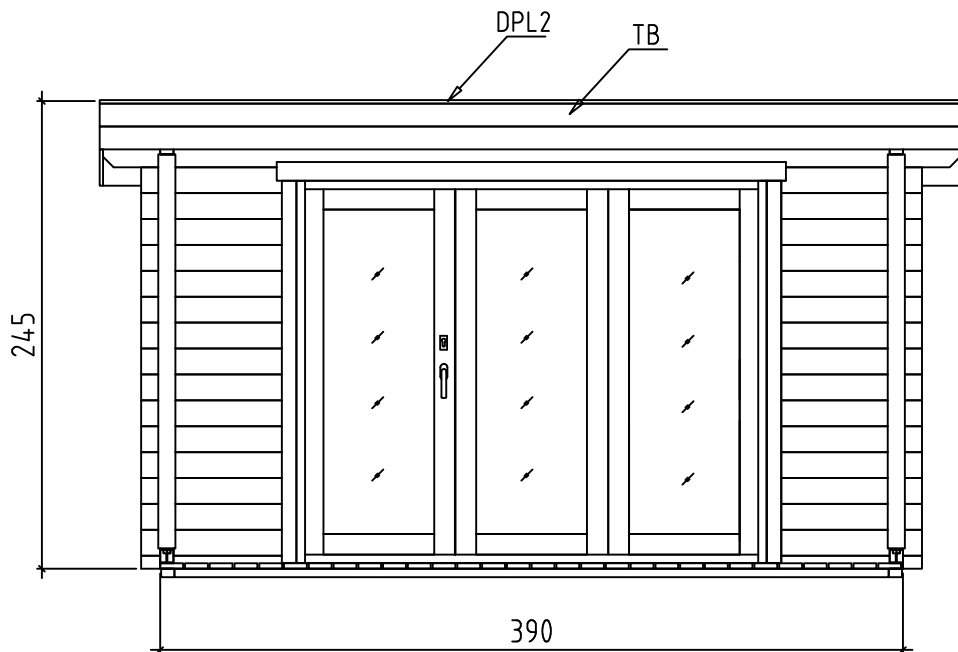

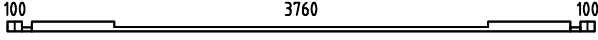
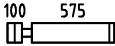
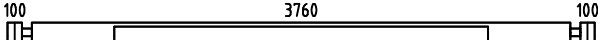
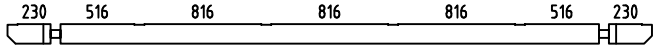
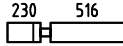
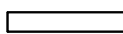
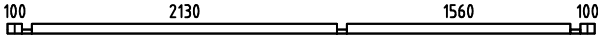
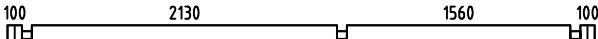

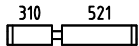
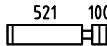
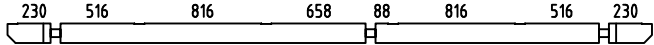
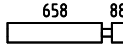
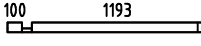

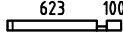
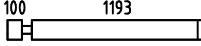

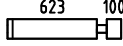
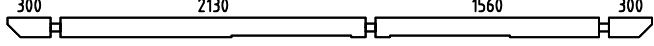
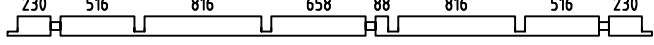
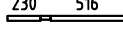
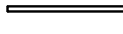
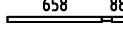
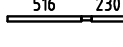

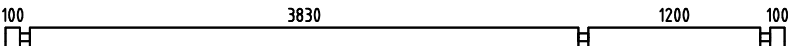

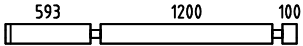
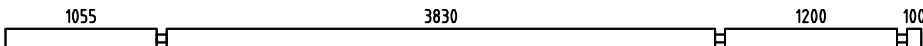
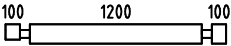
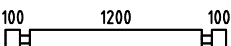
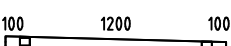
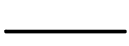
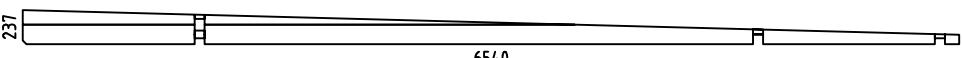
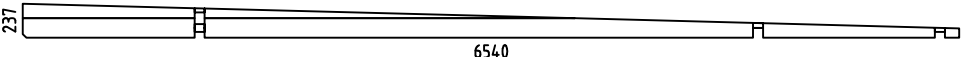
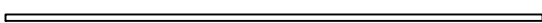



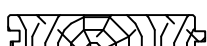



















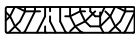



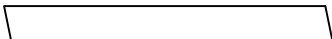
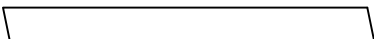
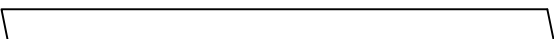
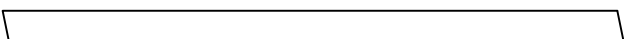

Pos	Exeter 1 - Art.No.7012202 Piece list - Stückliste - Liste des pieces	Q.	P (mm)	L (mm)
001		1	70x68	4100
002		28	70x136	745
003		1	70x136	4100
004		1	70x136	4500
005		4	70x136	816
006		5	70x136	816
007		1	70x68	4100
008		10	70x136	4100
009		4	70x136	480
010		4	70x136	901
011		4	70x136	691
012		1	70x136	4500
013		1	70x136	816
014		1	70x68	1363
015		1	70x68	270
016		1	70x68	793
017		14	70x136	1363
018		14	70x136	270
019		14	70x136	793
020		1	70x136	4500
021		1	70x136	4500
022		1	70x35	816
023		2	70x35	816
024		1	70x35	816
025		1	70x35	816

Pos	Exeter 1 - Art.No.7012202 Piece list - Stückliste - Liste des pieces	Q.	P (mm)	L (mm)
026		17	70x136	5440
027		13	70x136	533
028		26	70x136	593
029		13	70x136	2034
030		2	70x136	6395
033		1	70x136	1540
034		15	70x136	1540
035		1	70x106	1540
036		2	70x10	837
WA-1		1		
WB-1		1		
IAR3	FOUNDATION - FUNDAMENT - FONDATION 	15	70x45	3750
IAR2	FOUNDATION - FUNDAMENT - FONDATION 	2	70x45	3218
IAR1	FOUNDATION - FUNDAMENT - FONDATION 	2	70x45	3218
SR1	RAFTER - DACHSPARREN - CHEVRON 	6	70x140	6746
PTL	FLOOR BOARDS - FUSSBODENBRETTER - LAME DE PLANCHER 	34	112x28	3826
PTL	FLOOR BOARDS - FUSSBODENBRETTER - LAME DE PLANCHER 	33	112x28	1196
	ROOF BOARDS - DACHBRETTER - VOLIGES 	75	90x18	4500
SV2	TERRACE BOARDS - TERRASSENBRETTER - PLANCHER DE TERRASSE 	30	120x28	1105
	FLOOR FILLET-FUSSBODENLEISTE - CORNIERE DE FINITION DU PLANCHER 		15x40	27.3 m.
DPL1	ROOFING FELT FILLET - DACHPAPPENLEISTE - BAGUETTE DE FIXATION DU FEUTRE BITUMEUX 	4	18x58	3360
DPL2	ROOFING FELT FILLET - DACHPAPPENLEISTE - BAGUETTE DE FIXATION DU FEUTRE BITUMEUX 	1	18x58	4538
M12	TREADED ROD M12 - GEWINDESTANGE M12 - TIGE FILETÉE M12 	2		270
M12	TREADED ROD M12 - GEWINDESTANGE M12 - TIGE FILETÉE M12 	2		410
M12	TREADED ROD M12 - GEWINDESTANGE M12 - TIGE FILETÉE M12 	4		2000

Pos	Exeter 1 - Art.No.7012202 Piece list - Stückliste - Liste des pieces	Q.	P (mm)	L (mm)
LPL	FIXING FILLET - FIXIRUNGSLEISTE - PROFIL DE FIXATION 	2	20x70	470
LPL	FIXING FILLET - FIXIRUNGSLEISTE - PROFIL DE FIXATION 	4	20x70	510
LPL	FIXING FILLET - FIXIRUNGSLEISTE - PROFIL DE FIXATION 	6	20x70	512
LPL	FIXING FILLET - FIXIRUNGSLEISTE - PROFIL DE FIXATION 	2	20x70	787
LPL	FIXING FILLET - FIXIRUNGSLEISTE - PROFIL DE FIXATION 	2	20x70	1460
LPL	FIXING FILLET - FIXIRUNGSLEISTE - PROFIL DE FIXATION 	6	20x70	1729
LPL	FIXING FILLET - FIXIRUNGSLEISTE - PROFIL DE FIXATION 	4	20x70	1933
LPL	FIXING FILLET - FIXIRUNGSLEISTE - PROFIL DE FIXATION 	2	20x70	2000
LPL	FIXING FILLET - FIXIRUNGSLEISTE - PROFIL DE FIXATION 	1	20x70	2560
P	POST - PFOSTEN - POTEAU 	2	90x90	2070
TB	EAVES BOARD - TRAUFBRETT - BANDEAU DE TOIT 	4	18x120	4538
TBE6	FIXING FILLET FOR WINDOW - FIXIRUNGSLEISTE FÜR FENSTER - PROFIL DE FIXATION DES FENETRES 	4	28x34	510
TBE6	FIXING FILLET FOR WINDOW - FIXIRUNGSLEISTE FÜR FENSTER - PROFIL DE FIXATION DES FENETRES 	6	28x34	1729
TBE6	FIXING FILLET FOR DOOR - FIXIRUNGSLEISTE FÜR TÜR - PROFIL DE FIXATION DES PORTES 	2	28x34	1836
TBE6	FIXING FILLET FOR DOOR - FIXIRUNGSLEISTE FÜR TÜR - PROFIL DE FIXATION DES PORTES 	4	28x34	1933
GL1	GABLE MOULDING - GIEBELLEISTE PLANCHE DE RIVE 	2	18x120	1237
GL2	GABLE MOULDING - GIEBELLEISTE PLANCHE DE RIVE 	2	18x120	1609
GL3	GABLE MOULDING - GIEBELLEISTE PLANCHE DE RIVE 	2	18x120	5140
GL4	GABLE MOULDING - GIEBELLEISTE PLANCHE DE RIVE 	2	18x120	5510
KL4	LENGTHENING BOLT FOR TREADED ROD - VERLÄNGERUNGSMUTTER FÜR GEWINDESTANGE - MANCHON DE RACCORDEMENT DE TIGE FILETÉE 	4		
KL1	DRIVE NUT TREADED ROD - EINSHLAGMUTTER FÜR GEWINDESTANGE - ÉCROU A FRAPPER POUR TIGE FILITÉE 	4		
KL2	NUT FOR TREADED ROD - MUTTER FÜR GEWINDESTANGE - ÉCROU POUR TIGE FILETÉE 	4		
KL3	PLAIN WASHER TREADED ROD - UNTERLEGSCHIEBE FÜR GEWINDESTANGE - RONDELLE PLATE POUR TIGE FILETÉE 	4		
HS83	SCREW FOR FIXING FILLET - SCHRAUBEN FÜR FIXIRUNGSLEISTE - VIS POUR PROFIL DE FIXATION 	121	3.5x50	
HS32	SCREW FOR EAVES BOARDS - SCHRAUBEN FÜR TRAUFBRETT - VIS DE FIXATION POUR BANDEAU DE TOIT 	56	3.5x50	

Pos	Exeter 1 - Art.No.7012202 Piece list - Stückliste - Liste des pieces		Q.	P (mm)	L (mm)
HS84	SCREW FOR FIXING FILLET - SCHRAUBEN FÜR FIXIRUNGSLEISTE - VIS POUR PROFIL DE FIXATION		72	3.5x50	
HS16	SCREW FOR GABLE MOULDING - SCHRAUBEN FÜR GIEBELLEISTE - VIS DE FIXATION POUR PLANCHE DE RIVE		66	3.5x50	
HS38	SCREW FOR FIXING TERRACE RAILING - SCHRAUBE FÜR TERRASSE VIS DE FIXATION DE GARDE-CORPS DE TERRASSE		10	4.5x80	
HS45	SCREW FOR SLIDING WALL TIE - SCHRAUBEN FÜR WAND SCHIEBEREGLER SCHIEBEREGLER - VIS POUR FIXATION ÉQUERRE MÉTALLIQUE AU PARAVENT		16	4x20	
NFD	SCREW FOR ROOFING FELT FILLET - SCHRAUBEN FÜR DACHPAPPENLEISTE VIS POUR BAGUETTE FIXATION FEUTRE BITUMEUX		42	4x40	
HS34	SCREW FOR POST - SCHRAUBEN FÜR PFOSTEN - VIS DE FIXATION DES POTEAUX		4	4x60	
HS40	SCREW FOR 1. WALL BEAM - SCHRAUBE FÜR 1. BOHLENREIHE - VIS DE FIXATION DES FONDATIONS		12	5x120	
HS39	SCREW FOR FUNDAMENT - SCHRAUBEN ZUR BEFESTIGUNG FUNDAMENT - VIS POUR FONDATION		64	5x120	
HS42	SCREW FOR GABLE - SCHRAUBEN FÜR GIEBEL - VIS POUR FIXATION DES PIGNONS		8	5x120	
HS48	SCREW FOR Pos. 005; 006; 013 - SCHRAUBEN FÜR für Pos. 005; 006; 013 VIS POUR FIXATION DERNIÈRE RANGÉE MADRIERS (Pos. 005; 006; 013)		20	6x180	
HS44	SCREW FOR RAFTER - SCHRAUBEN ZUR BEFESTIGUNG DACHSPARREN - VIS POUR CHEVRON		18	6x180	
HS49	SCREW FOR POST HEIGHT ADJUSTMENT - SCHRAUBEN FÜR REGULIERUNGSSCHRAUBE FÜR PFOSTEN - VIS DE FIXATION DE SUPPORT RÉGLABLE DE POTEAU		16	6x50	
MS	SCREW FOR DOORSTEP - SCHRAUBEN FÜR TÜRSCHWELLE - VIS DE FIXATION DU SEUIL DE PORTE		4	4.5x65	
HS72	SCREW FOR SLIDING WALL TIE - SCHRAUBEN FÜR WAND SCHIEBEREGLER - VIS POUR FIXATION ÉQUERRE MÉTALLIQUE AU PARAVENT		4	5x60	
SH70	HAMMER BLOCK - SCHLAGHOLZ - CALLE DE FRAPPE		1		
NF3	ZN NAIL FOR TERRACE - ZN NÄGEL FÜR TERRASSENBRETT - POINTE POUR PLANCHER DE TERRASSE		200	2x50	
NFF	ZN NAIL FOR FLOOR FILLETS - ZN NÄGEL FÜR FUSSBODENLEISTEN - POINTE POUR PANNEAUX DE PLANCHER		55	1.4x40	
NF2	ZN NAIL FOR ROOF - ZN NÄGEL FÜR DACHBRETT - POINTE POUR TOIT		640	2x50	
NH1	ZN NAIL FOR FLOOR - ZN NÄGEL FÜR FUSSBODENBRETT - CLOUS POUR PLANCHER		360	2x50	
KL5	PLAIN WASHER FOR SLIDING WALL TIE - UNTERLEGSCHEIBE FÜR WAND SCHIEBEREGLER - RONDELLE POUR SABOT MÉTALLIQUE		4		
WLGR	SLIDING WALL TIE - SCHIEBEREGLER FÜR WAND - EQUERRE MÉTALLIQUE DE FIXATION DU PARAVENT		4		
RFP	POST HEIGHT ADJUSTMENT - REGULIERUNGSSCHRAUBE FÜR PFOSTEN - SUPPORT RÉGLABLE DE POTEAU		2		
ORZ	MONTAGE SET FOR DOORS AND WINDOWS - MONTAGE-SET FÜR TÜREN UND FENSTER - JEU DE MONTAGE PORTES ET FENETRES		1		

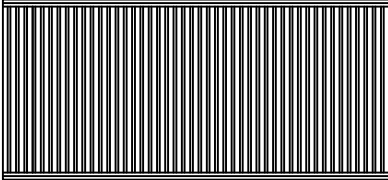
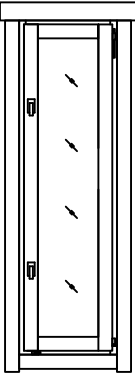
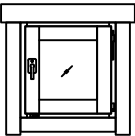
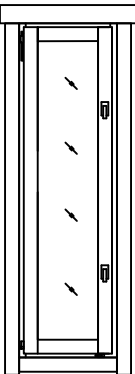
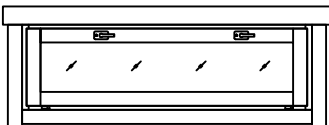
Pos	Exeter 1 - Art.No.7012202 Piece list - Stückliste - Liste des pieces	Q.	P (mm)	L (mm)
TRR2	TERRACE RAILING - TERRASSE - GARDE-CORPS DE TERRASSE 	1	910	1932
2+ A .0P.b	WINDOW-FENSTER-FENETRE 552x1729 	2		
2+ A .0P.h	WINDOW-FENSTER-FENETRE 510x510 	1		
2+ A .0V.b	WINDOW-FENSTER-FENETRE 552x1729 	1		
2+ A.0Ü	WINDOW-FENSTER-FENETRE 1500x510 	1		

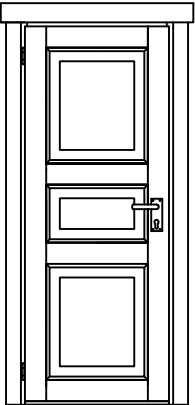
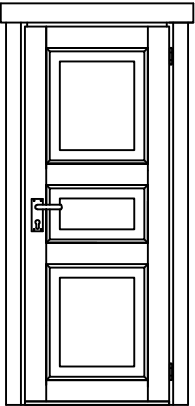
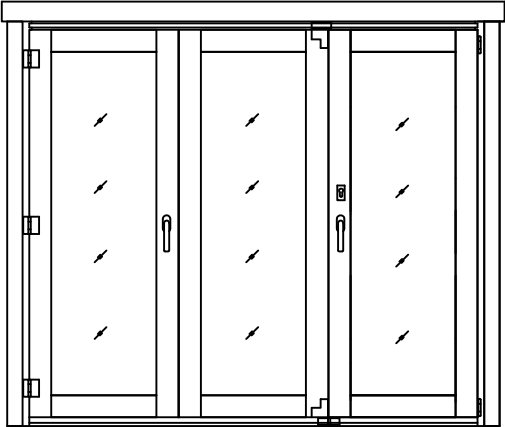
Pos	Exeter 1 - Art.No.7012202 Piece list - Stückliste - Liste des pieces	Q.	P (mm)	L (mm)
U.3TV	DOOR-TÜR-PORTE 827x1933 	1		
U.3TP	DOOR-TÜR-PORTE 827x1933 	1		
2+	DOOR-TÜR-PORTE 2600x2000  Montage video for 2600x2000 door - Montage video für 2600x2000 Tür - Video de montage porte 2600x2000 http://www.orthez.ee/Folding_new.mp4	1		

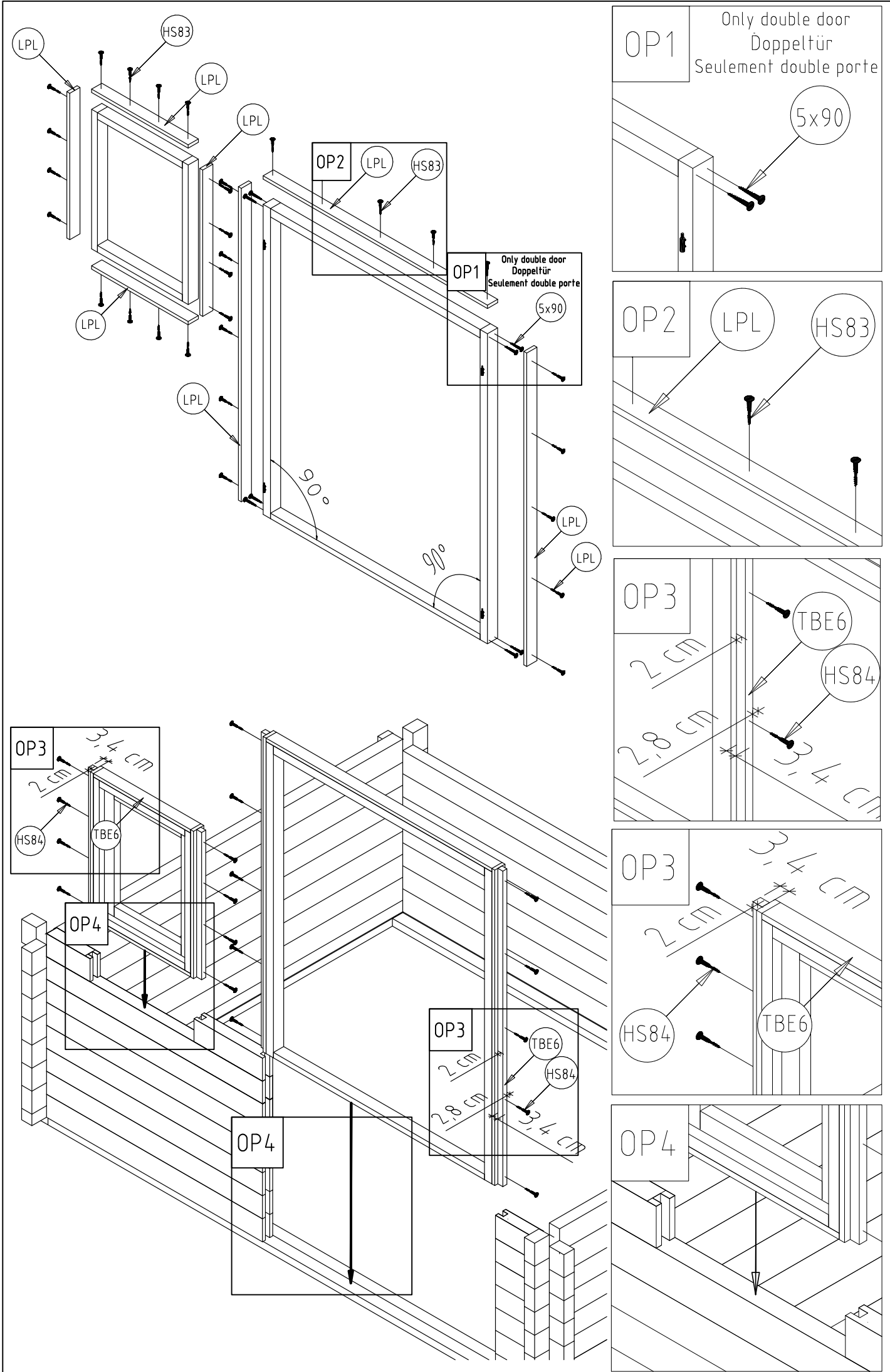

OP1 Only double door
Doppeltür
Seulement double porte

