

Columbia
Art.No. 703241

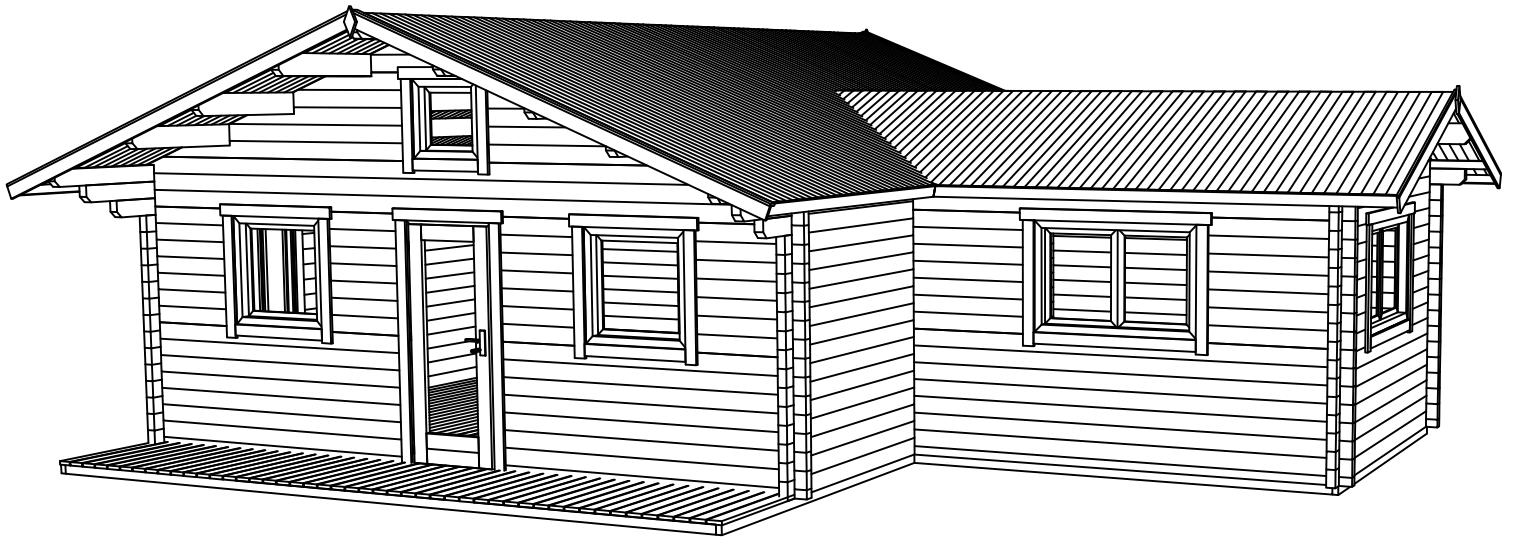

Columbia, Art.No.70324.1
GRUNDPLAN - GRUNDPLAN - PLAN DE MASSE

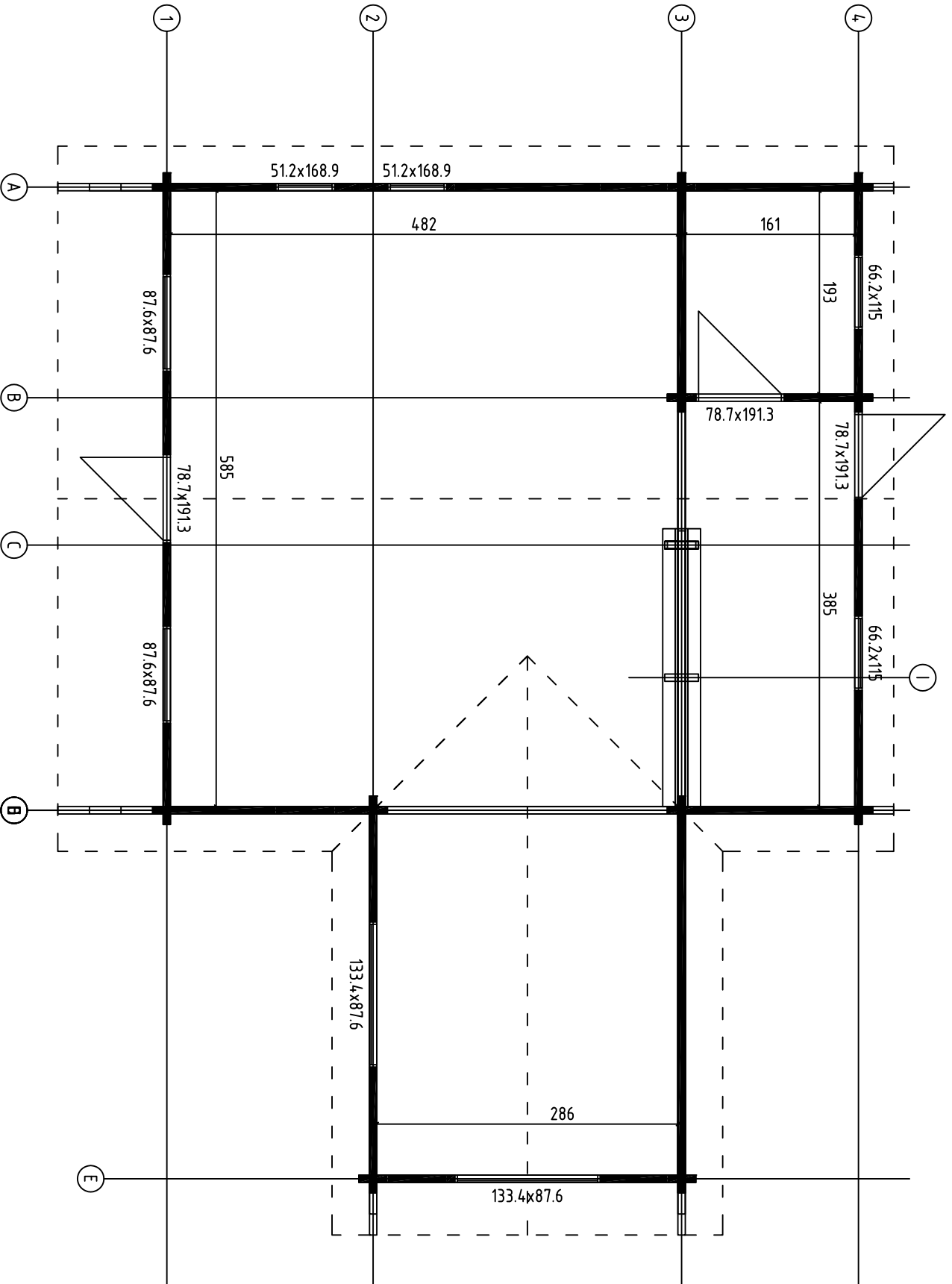

Columbia, Art.No.70324.1
 FOUNDATION - FUNDAMENT - FONDATION

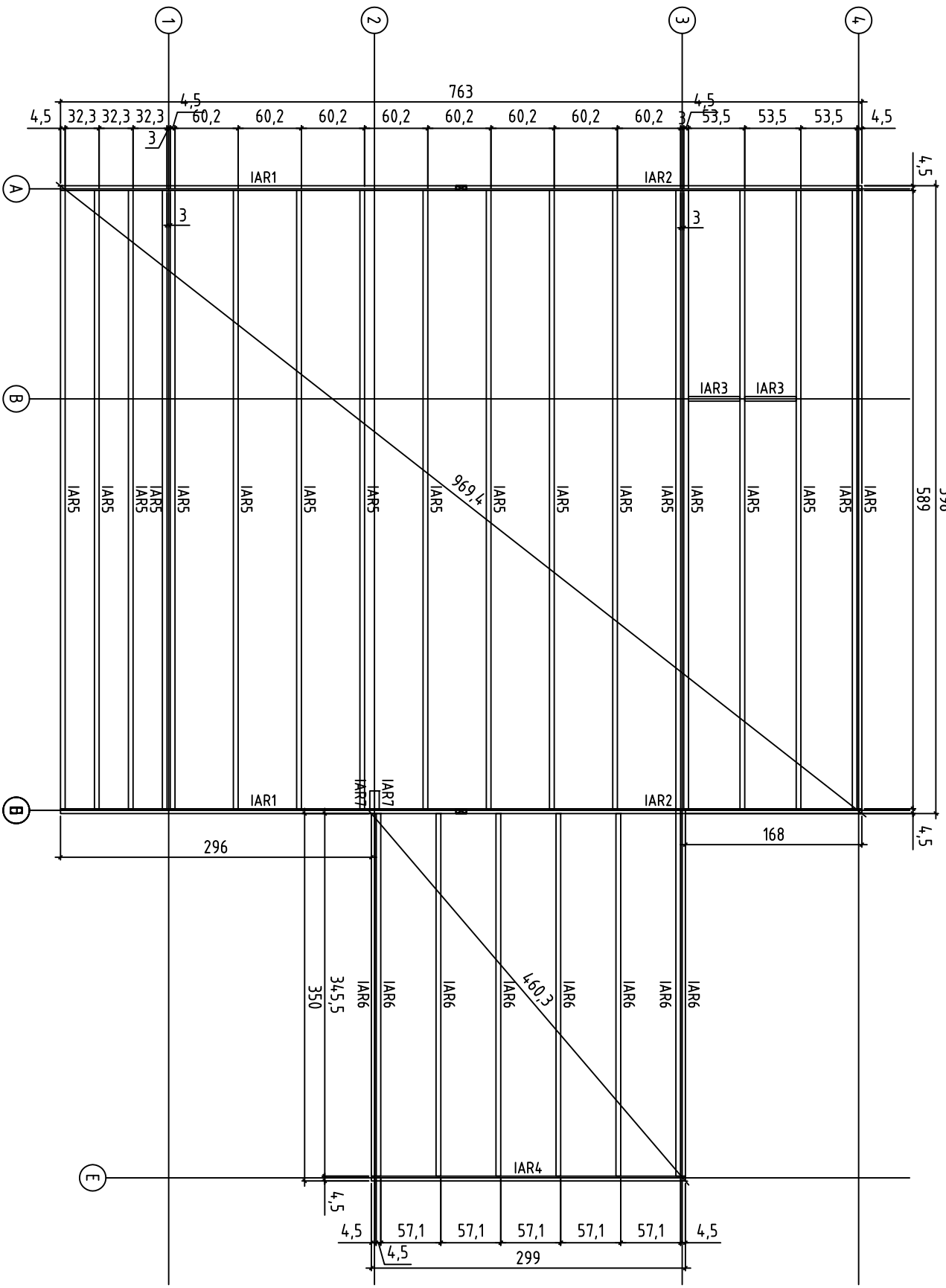

Columbia, Art.No.703241
FLOOR BOARDS - FUSSBODENBREITER - PLAN POSE PLANCHER

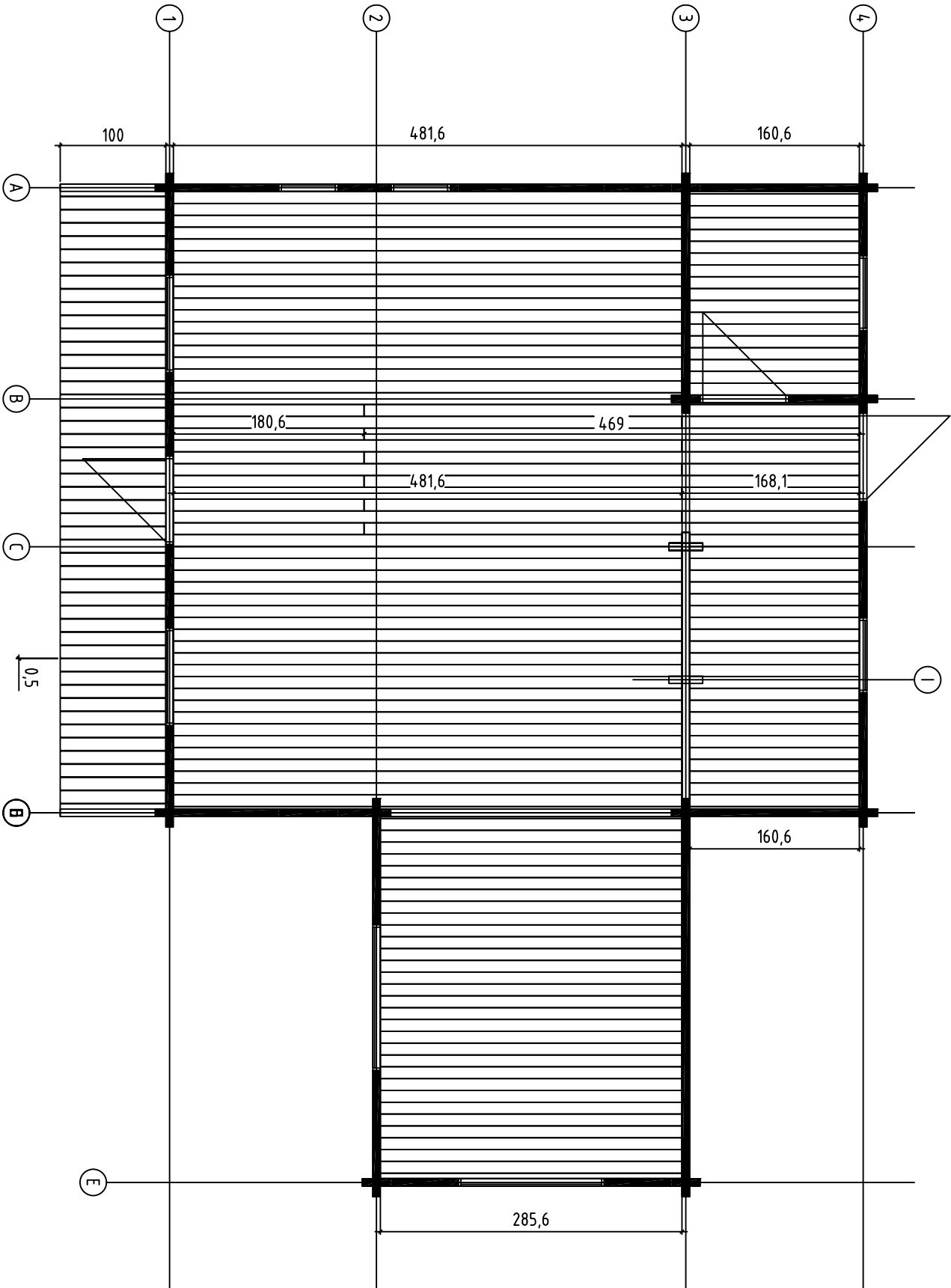

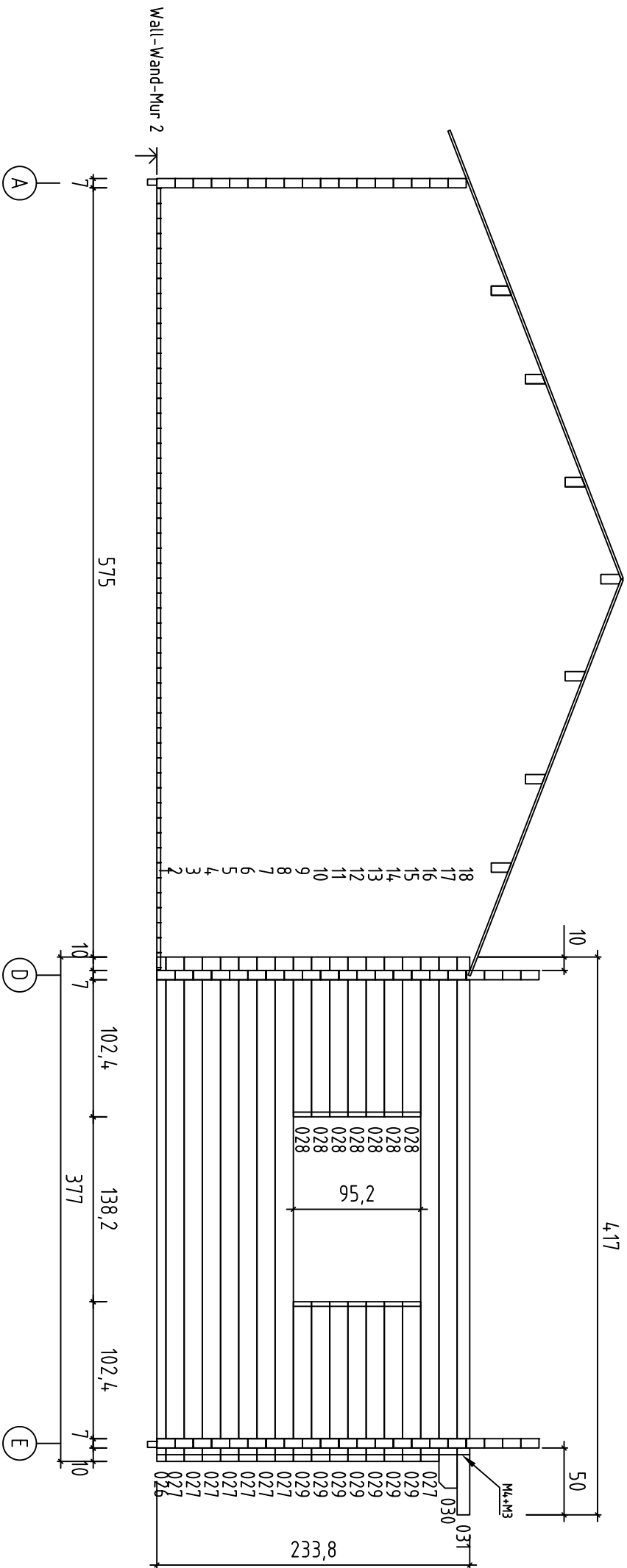

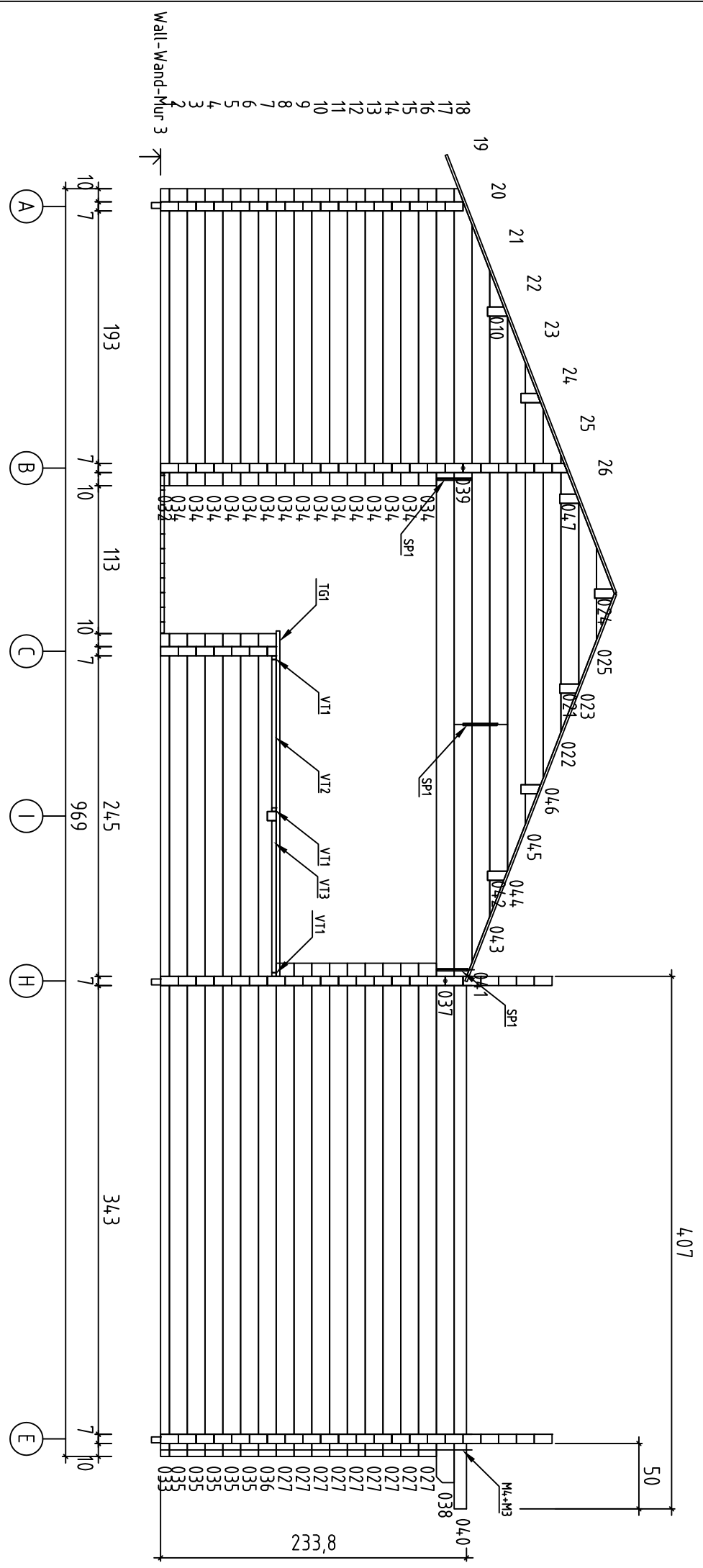

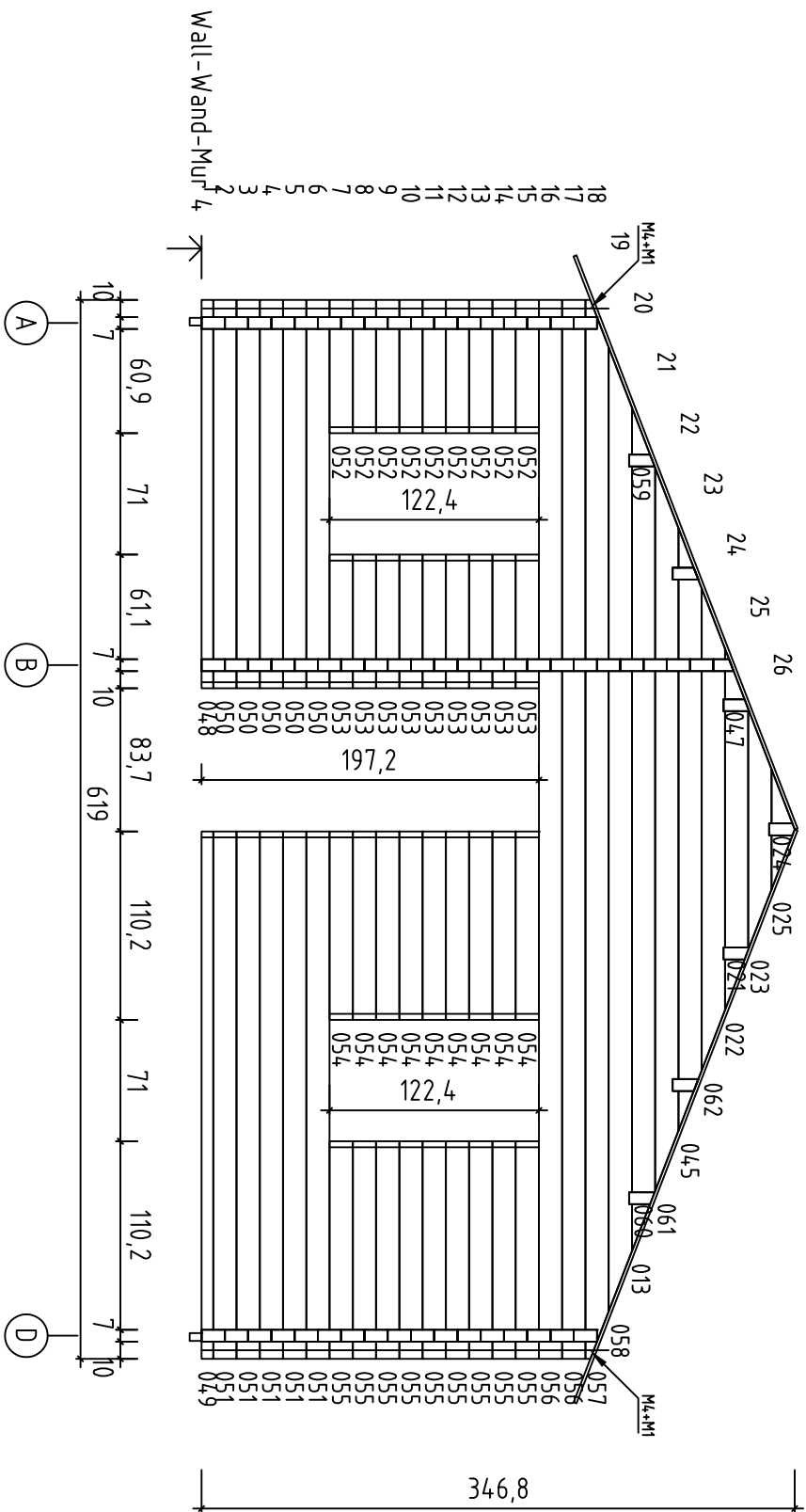

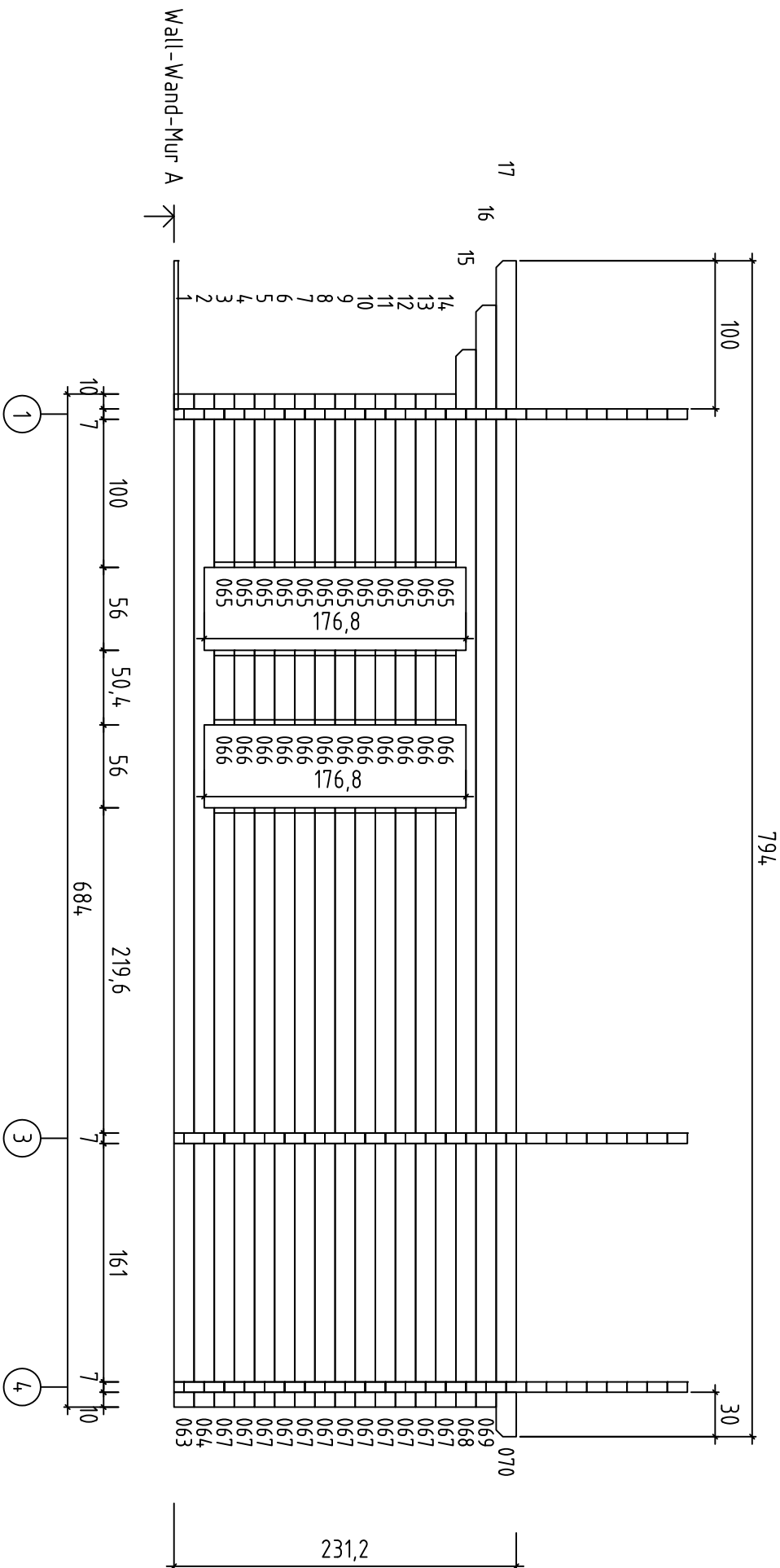

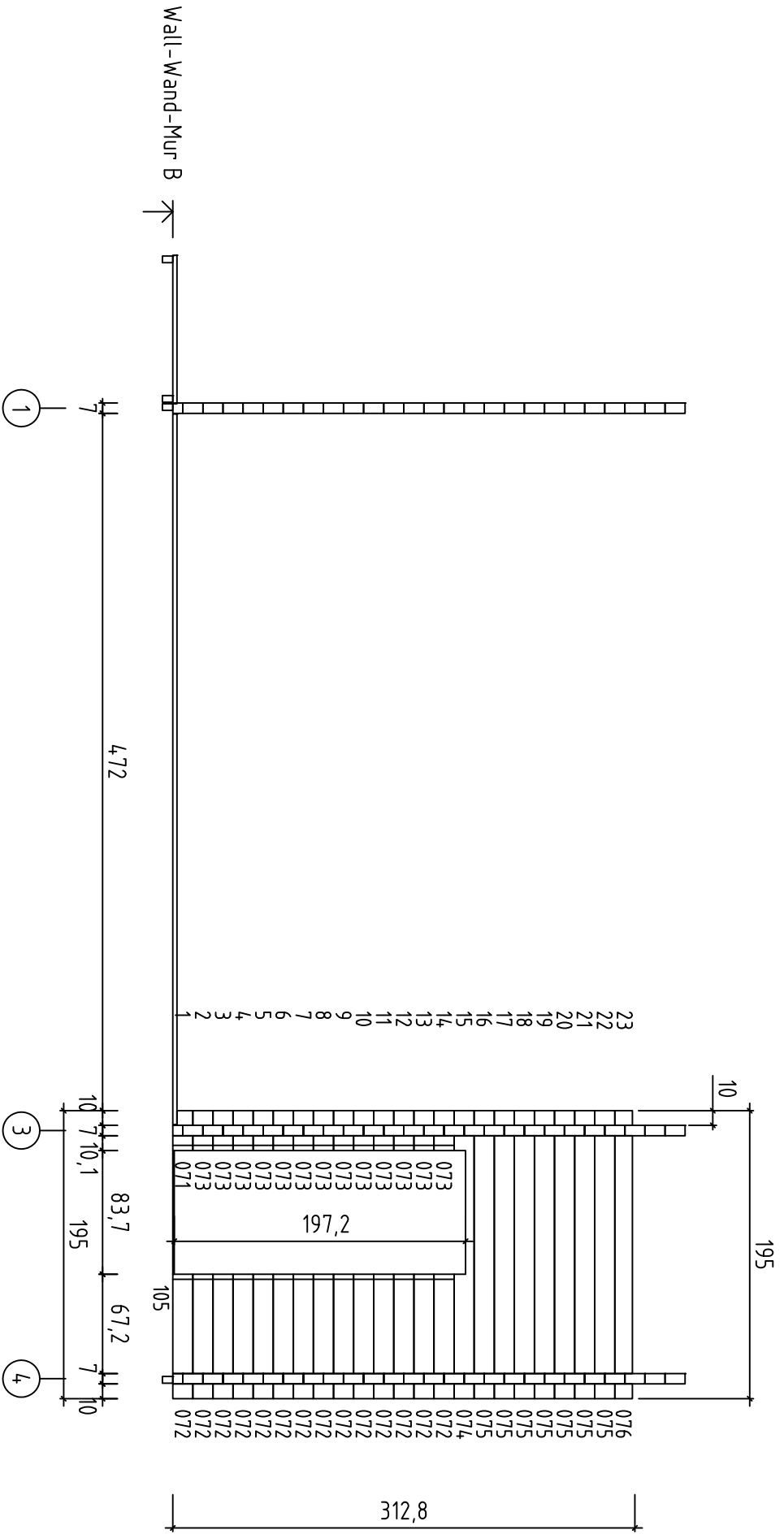

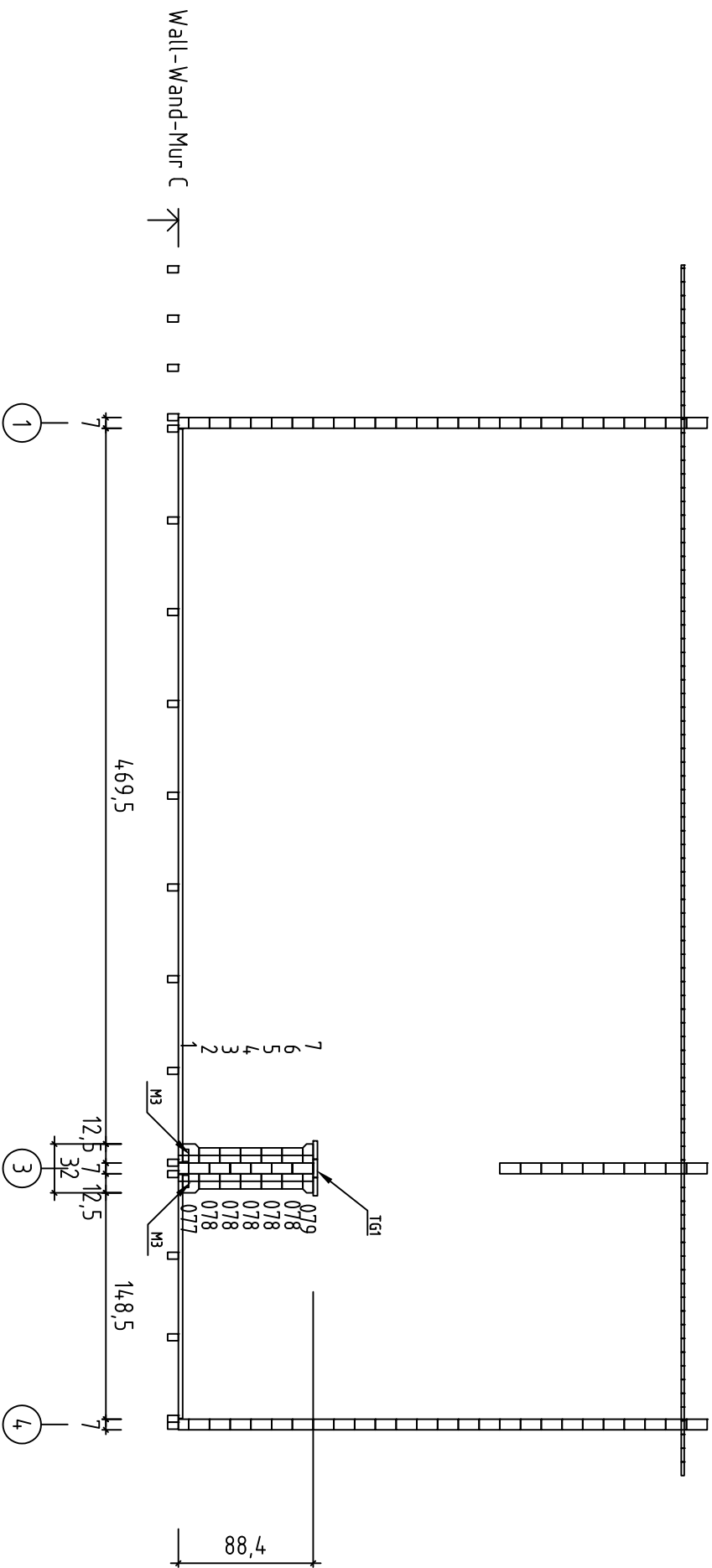

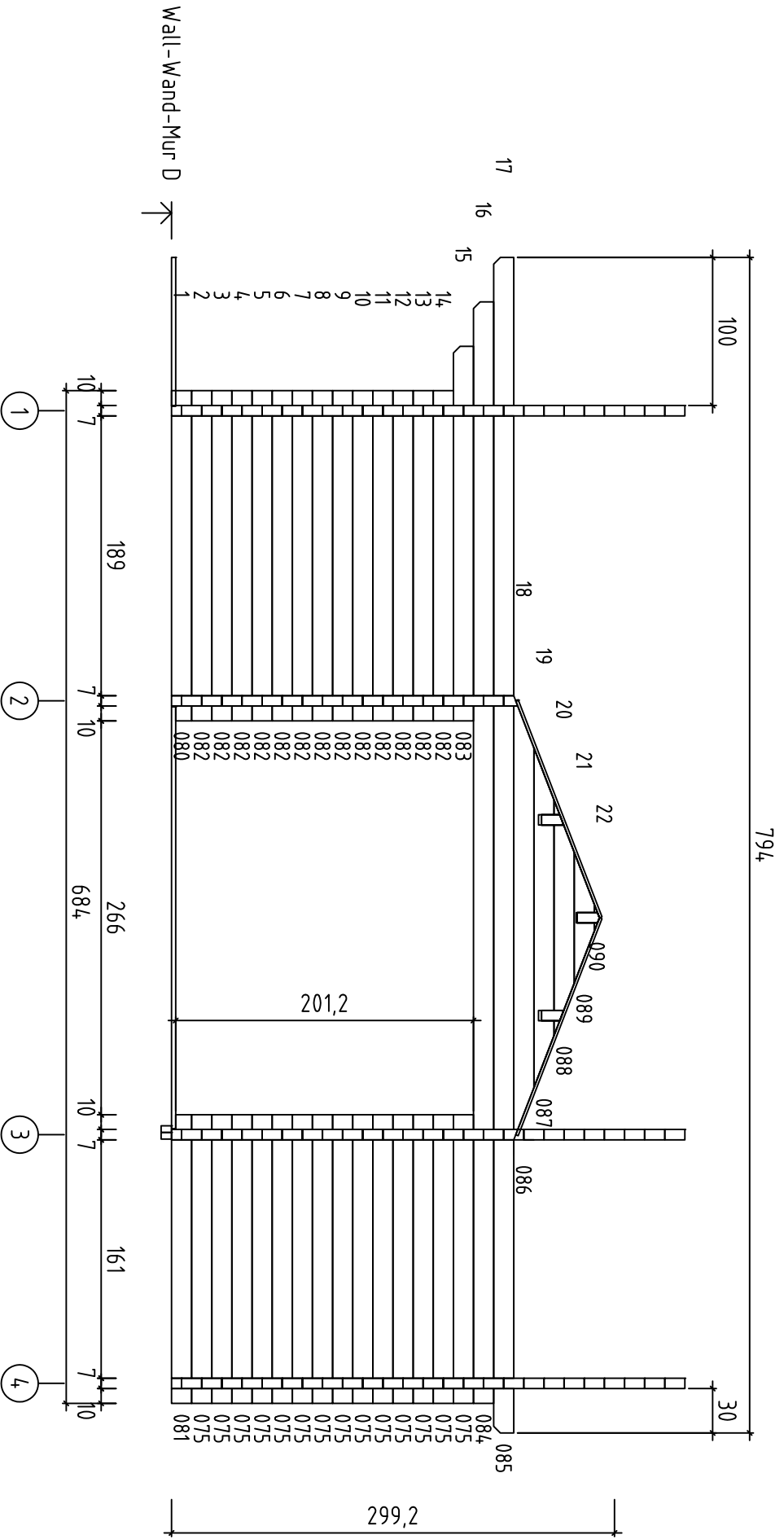

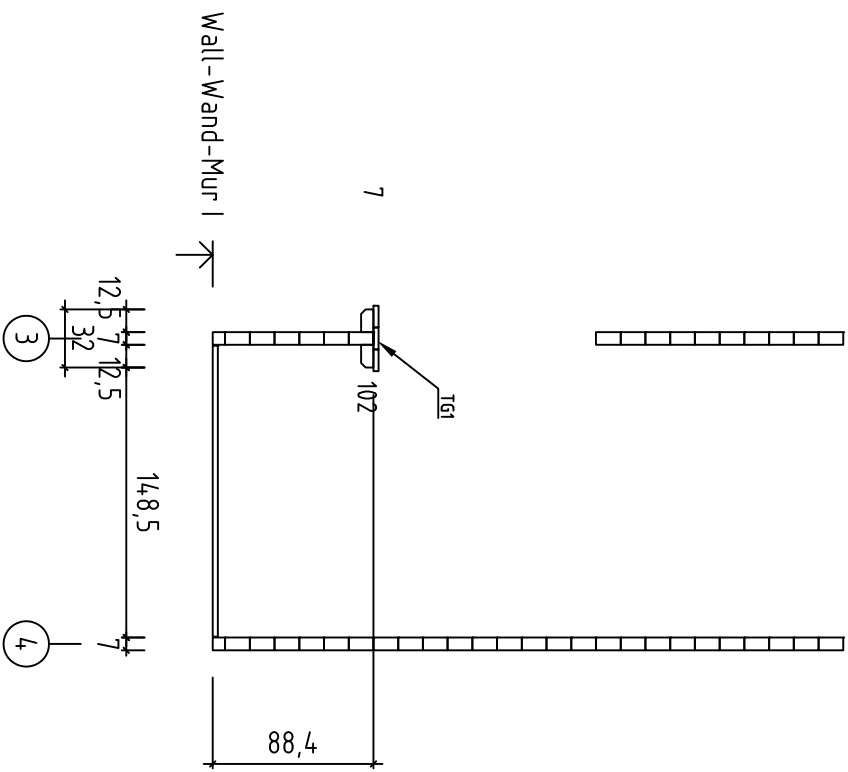
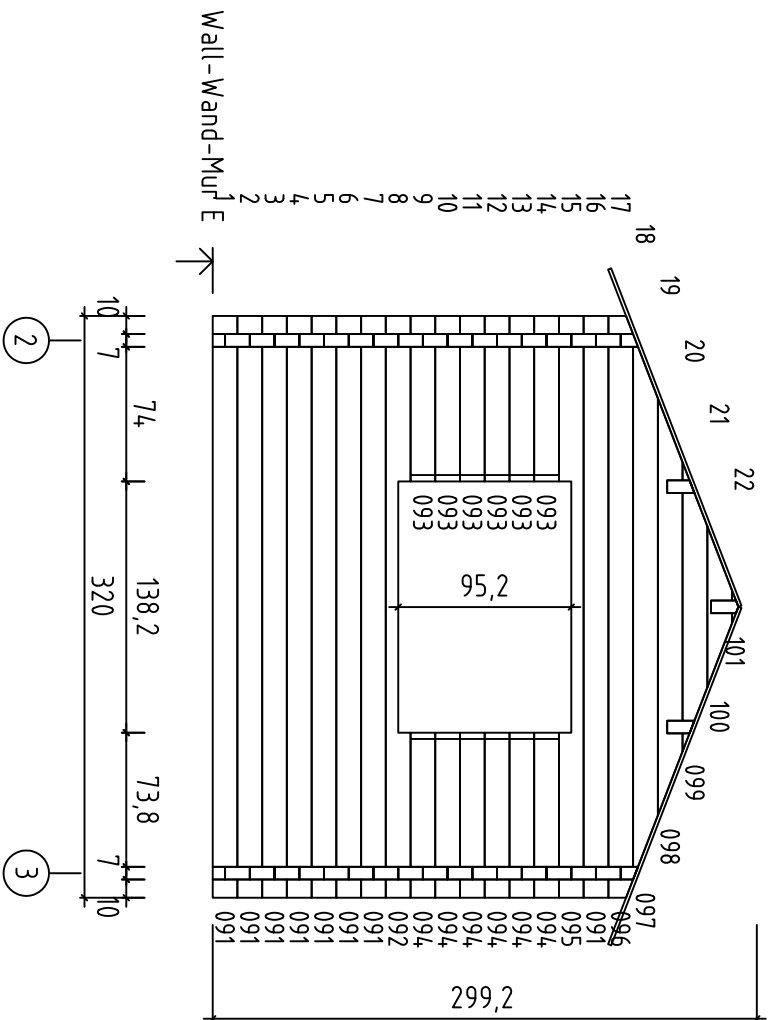

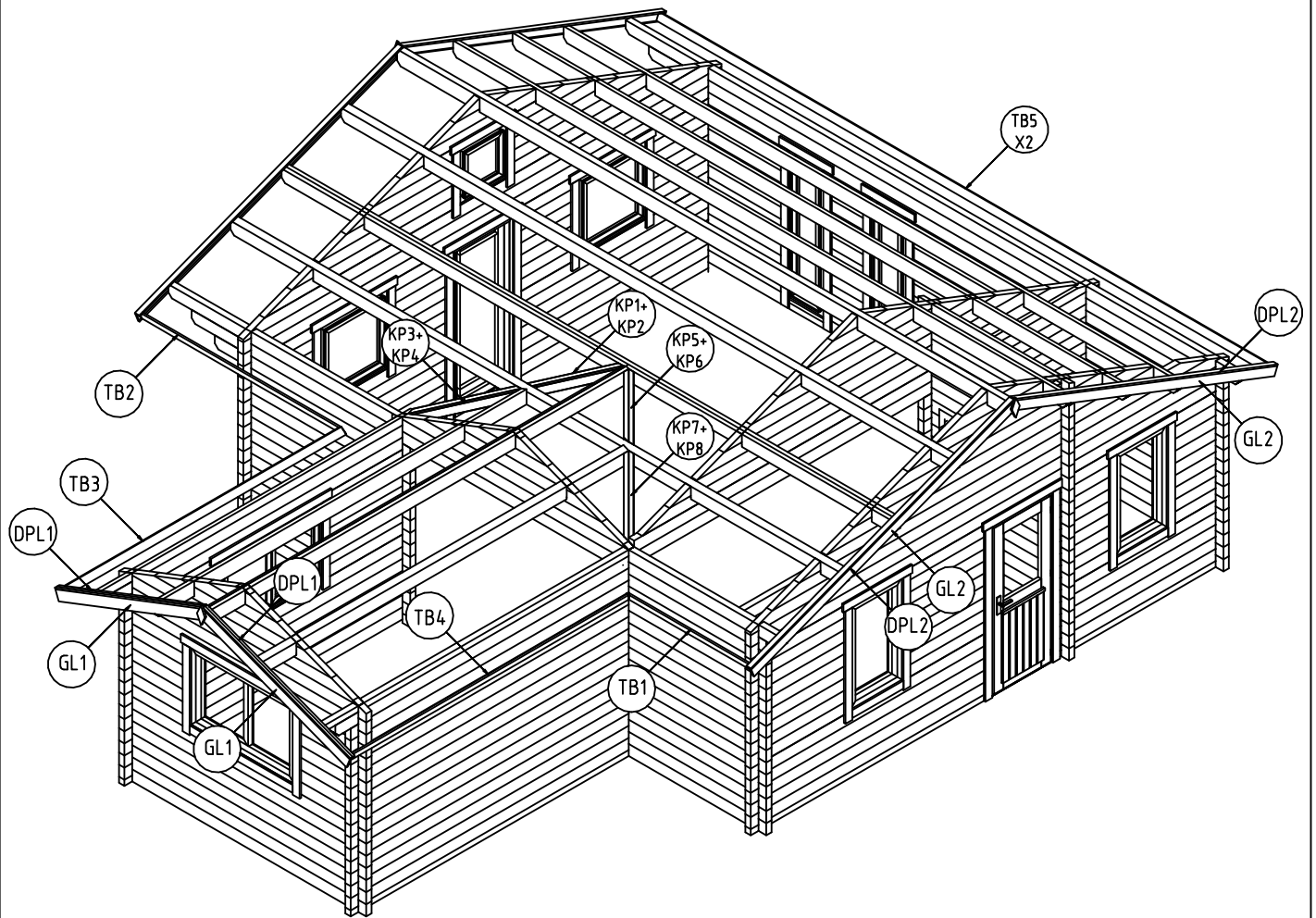

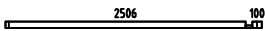
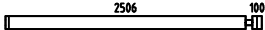

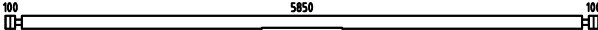
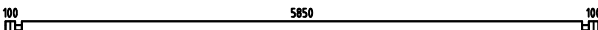
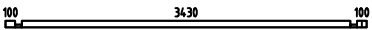
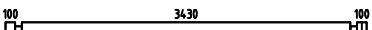
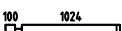
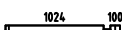
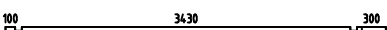
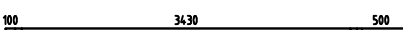









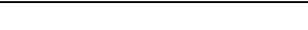



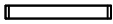
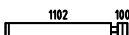

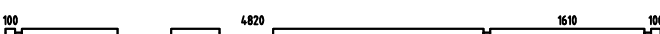

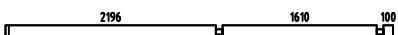





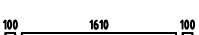











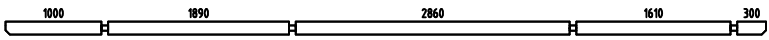
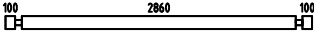
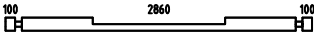

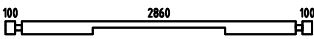

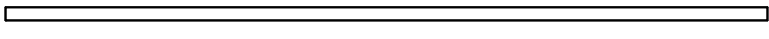

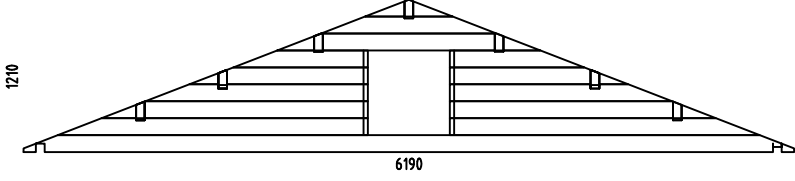
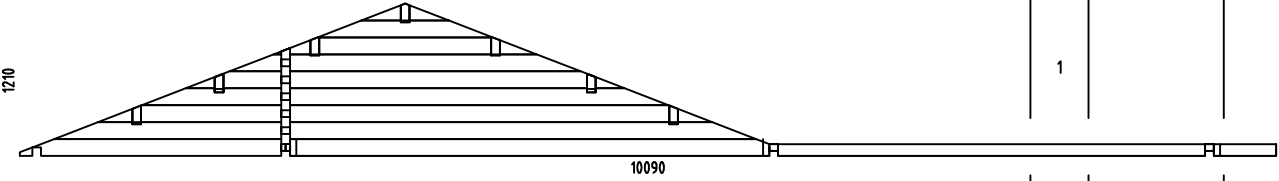
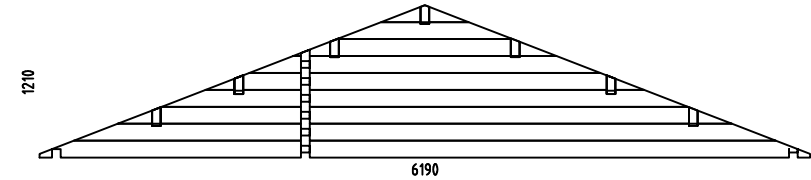
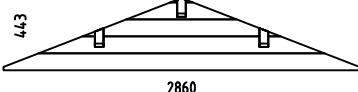
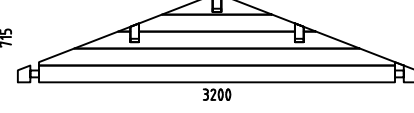
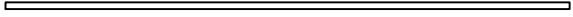



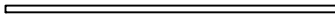
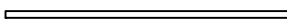

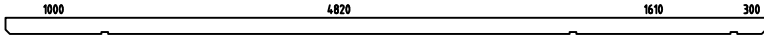
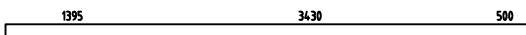
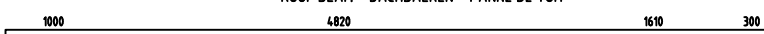
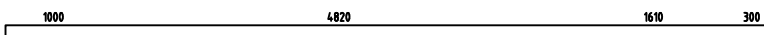
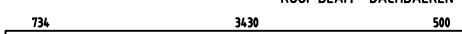
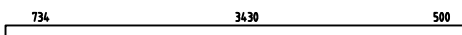
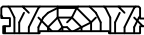

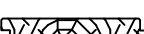
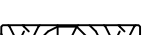
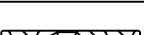
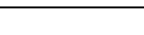













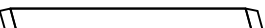

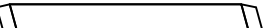

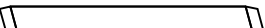











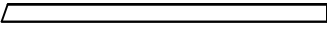
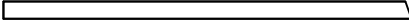
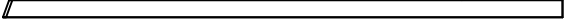
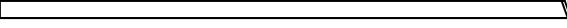



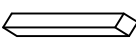











Pos	Columbia, Art.No.703241 Piece list - Stückliste - Liste des pieces	Q.	P (mm)	L (mm)
001		2	70x68	2676
002		14	70x136	2676
003		14	70x136	961
004		14	70x136	791
005		1	70x136	6190
006		1	70x136	6190
026		1	70x68	3770
027		17	70x136	3770
028		7	70x136	1194
029		7	70x136	1194
030		1	70x136	3970
031		1	70x94	4170
032		1	70x68	2270
033		1	70x68	6290
034		15	70x136	2270
035		5	70x136	6290
036		1	70x136	6290
037		1	70x136	6055
038		1	70x136	3835
048		1	70x68	2270
049		1	70x68	3083
050		5	70x136	2270
051		5	70x136	3083
052		9	70x136	779
053		9	70x136	781



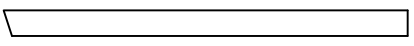
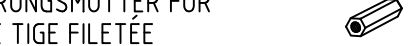















Pos	Columbia, Art.No.703241 Piece list - Stückliste - Liste des pieces	Q.	P (mm)	L (mm)
054		9	70x136	1102
055		9	70x136	1272
056		2	70x136	6190
063		1	70x136	6840
064		1	70x136	6840
065		12	70x136	1170
066		12	70x136	504
067		12	70x136	4046
068		1	70x136	7140
069		1	70x136	7440
070		1	70x136	7940
071		1	70x136	271
072		14	70x136	843
073		13	70x136	271
074		1	70x136	1950
075		21	70x136	1950
076		1	70x119	1950
077		1	70x136	320
078		5	70x136	270
079		1	70x68	320
080		1	70x136	2230
081		1	70x136	1950
082		13	70x136	2230
083		1	70x136	2530
084		1	70x136	7440

Pos	Columbia, Art.No.703241 Piece list - Stückliste - Liste des pieces	Q.	P (mm)	L (mm)
085		1	70x136	7940
091		8	70x136	3200
092		1	70x136	3200
093		6	70x136	910
094		6	70x136	908
095		1	70x136	3200
102		1	70x68	320
103	SPARE PART - ERSATZTEIL - PIECES DE RECHANGE 	1	70x136	7955
104		1	70x10	838
105		1	70x10	837
W1-1		1		
W3-1		1		
W4-1		1		
WD-1		1		
WE-1		1		
IAR5	FOUNDATION - FUNDAMENT - FONDATION 	18	45x70	5890
IAR2	FOUNDATION - FUNDAMENT - FONDATION 	2	45x70	3865
IAR1	FOUNDATION - FUNDAMENT - FONDATION 	2	45x70	3865

Pos	Columbia, Art.No.703241 Piece list - Stückliste - Liste des pieces	Q.	P (mm)	L (mm)
IAR6	FOUNDATION - FUNDAMENT - FONDATION 	8	45x70	3455
IAR4	FOUNDATION - FUNDAMENT - FONDATION 	1	45x70	2990
IAR3	FOUNDATION - FUNDAMENT - FONDATION 	2	45x70	490
IAR7	FOUNDATION - FUNDAMENT - FONDATION 	2	45x70	170
PR11	ROOF BEAM - DACHBALKEN - PANNE DE TOIT 	1	70x170	7940
PR12	ROOF BEAM - DACHBALKEN - PANNE DE TOIT 	1	70x170	5465
PR22	ROOF BEAM - DACHBALKEN - PANNE DE TOIT 	3	70x170	7940
PR21	ROOF BEAM - DACHBALKEN - PANNE DE TOIT 	3	70x170	7940
PR24	ROOF BEAM - DACHBALKEN - PANNE DE TOIT 	1	70x170	4804
PR23	ROOF BEAM - DACHBALKEN - PANNE DE TOIT 	1	70x170	4804
PTL	FLOOR BOARDS - FUSSBODENBRETTER - LAME DE PLANCHER 	47	112x28	4816
PTL	FLOOR BOARDS - FUSSBODENBRETTER - LAME DE PLANCHER 	6	112x28	4690
PTL	FLOOR BOARDS - FUSSBODENBRETTER - LAME DE PLANCHER 	31	112x28	2856
PTL	FLOOR BOARDS - FUSSBODENBRETTER - LAME DE PLANCHER 	6	112x28	1806
PTL	FLOOR BOARDS - FUSSBODENBRETTER - LAME DE PLANCHER 	6	112x28	1681
PTL	FLOOR BOARDS - FUSSBODENBRETTER - LAME DE PLANCHER 	42	112x28	1606
	ROOF BOARDS - DACHBRETTER - VOLIGES 	178	90x18	3590
	ROOF BOARDS - DACHBRETTER - VOLIGES 	86	90x18	1989
SV2	TERRACE BOARDS - TERRASSENBRETTER - PLANCHER DE TERRASSE 	48	120x28	1000
	FLOOR FILLET-FUSSBODENLEISTE - CORNIERE DE FINITION DU PLANCHER 		15x40	44 m.
DPL1	ROOFING FELT FILLET - DACHPAPPENLEISTE - BAGUETTE DE FIXATION DU FEUTRE BITUMEUX 	2	18x58	2050
DPL2	ROOFING FELT FILLET - DACHPAPPENLEISTE - BAGUETTE DE FIXATION DU FEUTRE BITUMEUX 	4	18x58	3650
M1	TREADED ROD M12 - GEWINDESTANGE M12 - TIGE FILETÉE M12 	4		323
M2	TREADED ROD M12 - GEWINDESTANGE M12 - TIGE FILETÉE M12 	2		370
M3	TREADED ROD M12 - GEWINDESTANGE M12 - TIGE FILETÉE M12 	2		835

Pos	Columbia, Art.No.703241 Piece list - Stückliste - Liste des pieces	Q.	P (mm)	L (mm)
M4	TREADED ROD M12 - GEWINDESTANGE M12 TIGE FILETÉE M12 	6		2000
KP1	ROOF CONSTRUCTION - DACHKONSTRUKTION - STRUCTURE DE TOIT 	1	45x96	937
KP2	ROOF CONSTRUCTION - DACHKONSTRUKTION - STRUCTURE DE TOIT 	1	45x96	890
KP3	ROOF CONSTRUCTION - DACHKONSTRUKTION - STRUCTURE DE TOIT 	1	45x96	1099
KP4	ROOF CONSTRUCTION - DACHKONSTRUKTION - STRUCTURE DE TOIT 	1	45x96	1099
KP5	ROOF CONSTRUCTION - DACHKONSTRUKTION - STRUCTURE DE TOIT 	1	45x96	937
KP6	ROOF CONSTRUCTION - DACHKONSTRUKTION - STRUCTURE DE TOIT 	1	45x96	890
KP7	ROOF CONSTRUCTION - DACHKONSTRUKTION - STRUCTURE DE TOIT 	1	45x96	1099
KP8	ROOF CONSTRUCTION - DACHKONSTRUKTION - STRUCTURE DE TOIT 	1	45x96	1099
LL	CEILING FILLET - DECKELEISTE - PROFIL DE FINITION POUR SOUS PLAFOND 		15x40	17.2 m.
LPL	FIXING FILLET - FIXIRUNGSLEISTE - PROFIL DE FIXATION 	4	20x70	512
LPL	FIXING FILLET - FIXIRUNGSLEISTE - PROFIL DE FIXATION 	2	20x70	610
LPL	FIXING FILLET - FIXIRUNGSLEISTE - PROFIL DE FIXATION 	2	20x70	650
LPL	FIXING FILLET - FIXIRUNGSLEISTE - PROFIL DE FIXATION 	4	20x70	662
LPL	FIXING FILLET - FIXIRUNGSLEISTE - PROFIL DE FIXATION 	3	20x70	787
LPL	FIXING FILLET - FIXIRUNGSLEISTE - PROFIL DE FIXATION 	4	20x70	876
LPL	FIXING FILLET - FIXIRUNGSLEISTE - PROFIL DE FIXATION 	8	20x70	916
LPL	FIXING FILLET - FIXIRUNGSLEISTE - PROFIL DE FIXATION 	4	20x70	1190
LPL	FIXING FILLET - FIXIRUNGSLEISTE - PROFIL DE FIXATION 	4	20x70	1334
LPL	FIXING FILLET - FIXIRUNGSLEISTE - PROFIL DE FIXATION 	4	20x70	1729
LPL	FIXING FILLET - FIXIRUNGSLEISTE - PROFIL DE FIXATION 	6	20x70	1933
TB1	EAVES BOARD - TRAUFBRETT - BANDEAU DE TOIT 	1	18x90	1651
TB2	EAVES BOARD - TRAUFBRETT - BANDEAU DE TOIT 	1	18x90	2631
TB3	EAVES BOARD - TRAUFBRETT BANDEAU DE TOIT 	1	18x90	3672
TB4	EAVES BOARD - TRAUFBRETT BANDEAU DE TOIT 	1	18x90	3672

Pos	Columbia, Art.No.703241 Piece list - Stückliste - Liste des pieces	Q.	P (mm)	L (mm)
TB5	EAVES BOARD - TRAUFBRETT - BANDEAU DE TOIT 	2	18x90	3970
SP1	HIDDEN FIXING - HOLZDÜBEL - TOURILLON BOIS 	3	18x18	260
DRV	ROOF EDGE REINFORCEMENT - DACHRANDVERSTÄRKUNG - CORNIERE DE RENFORT DE BORD DE TOIT 	1	28x34	1651
DRV	ROOF EDGE REINFORCEMENT - DACHRANDVERSTÄRKUNG - CORNIERE DE RENFORT DE BORD DE TOIT 	1	28x34	2631
DRV	ROOF EDGE REINFORCEMENT - DACHRANDVERSTÄRKUNG - CORNIERE DE RENFORT DE BORD DE TOIT 	2	28x34	2672
DRV	ROOF EDGE REINFORCEMENT - DACHRANDVERSTÄRKUNG - CORNIERE DE RENFORT DE BORD DE TOIT 	2	28x34	3970
TBE6	FIXING FILLET FOR WINDOW - FIXIRUNGSLEISTE FÜR FENSTER - PROFIL DE FIXATION DES FENETRES 	2	28x34	650
TBE6	FIXING FILLET FOR WINDOW - FIXIRUNGSLEISTE FÜR FENSTER - PROFIL DE FIXATION DES FENETRES 	2	28x34	748
TBE6	FIXING FILLET FOR WINDOW - FIXIRUNGSLEISTE FÜR FENSTER - PROFIL DE FIXATION DES FENETRES 	6	28x34	916
TBE6	FIXING FILLET FOR WINDOW - FIXIRUNGSLEISTE FÜR FENSTER - PROFIL DE FIXATION DES FENETRES 	4	28x34	1190
TBE6	FIXING FILLET FOR WINDOW - FIXIRUNGSLEISTE FÜR FENSTER - PROFIL DE FIXATION DES FENETRES 	4	28x34	1564
TBE6	FIXING FILLET FOR DOOR - FIXIRUNGSLEISTE FÜR TÜR - PROFIL DE FIXATION DES PORTES 	2	28x34	1826
TBE6	FIXING FILLET FOR DOOR - FIXIRUNGSLEISTE FÜR TÜR - PROFIL DE FIXATION DES PORTES 	4	28x34	1920
TG1	DESK BOARDS - TISCHBRETTER - PLATEAUX DE TABLE 	3	28x120	2640
VT3	HOLDER FOR DESK BOARDS - FIXIRUNGSLEISTE FÜR TISCHBRETTER - PROFIL DE FIXATION DES PLATEAUX DE TABLE 	2	28x34	1162
VT2	HOLDER FOR DESK BOARDS - FIXIRUNGSLEISTE FÜR TISCHBRETTER - PROFIL DE FIXATION DES PLATEAUX DE TABLE 	2	28x34	1134
VT1	HOLDER FOR DESK BOARDS - FIXIRUNGSLEISTE FÜR TISCHBRETTER - PROFIL DE FIXATION DES PLATEAUX DE TABLE 	6	28x34	125
GL1	GABLE MOULDING - GIBELLEISTE PLANCHE DE RIVE 	2	18x120	2050
GL2	GABLE MOULDING - GIBELLEISTE PLANCHE DE RIVE 	4	18x120	3650
KL4	LENGTHENING BOLT FOR TREADED ROD - VERLÄNGERUNGSMUTTER FÜR GEWINDESTANGE - MANCHON DE RACCORDEMENT DE TIGE FILETÉE 	6		
KL1	DRIVE NUT TREADED ROD - EINSHLAGMUTTER FÜR GEWINDESTANGE - ÉCROU A FRAPPER POUR TIGE FILITÉE 	8		
KL2	NUT FOR TREADED ROD - MUTTER FÜR GEWINDESTANGE - ÉCROU POUR TIGE FILETÉE 	8		
KL3	PLAIN WASHER TREADED ROD - UNTERLEGSCHIEBE FÜR GEWINDESTANGE - RONDELLE PLATE POUR TIGE FILETÉE 	8		
HS12	SCREW FOR GABLE SEGMENT - SCHRAUBEN FÜR DECKBLATT - VIS POUR FIXATION LOSANGE DE FINITION 	6	3.5x35	
HS83	SCREW FOR FIXING FILLET - SCHRAUBEN FÜR FIXIRUNGSLEISTE - VIS POUR PROFIL DE FIXATION 	186	3.5x50	

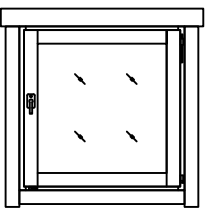
Pos	Columbia, Art.No.703241 Piece list - Stückliste - Liste des pieces	Q.	P (mm)	L (mm)
HS84	SCREW FOR FIXING FILLET - SCHRAUBEN FÜR FIXIRUNGSLEISTE - VIS POUR PROFIL DE FIXATION 	94	3.5x50	
HS16	SCREW FOR GABLE MOULDING - SCHRAUBEN FÜR GIEBELLEISTE - VIS DE FIXATION POUR PLANCHE DE RIVE 	52	3.5x50	
HS37	SCREW FOR ROOF CONSTRUCTION - SCHRAUBEN FÜR DACHKONSTRUKTION VIS POUR FIXATION DES STRUCTURE DE TOIT 	16	4.5x80	
HS37	SCREW FOR DESK BOARDS - SCHRAUBEN FÜR TISCHBRETTER - VIS POUR FIXATION DES PLATEAUX DE TABLE 	60	4.5x80	
HS32	SCREW FOR EAVES BOARDS - SCHRAUBEN FÜR TRAUFBRETTER - VIS DE FIXATION POUR BANDEAU DE TOIT 	44	4x40	
HS26	SCREW FOR ROOF EDGE REINFORCEMENT - SCHRAUBEN FÜR DACHRANDVERSTÄRKUNG - VIS POUR RENFORT DE BORD DE TOIT 	44	4x40	
HS17	SCREW FOR FLOOR BOARDS - SCHRAUBEN FÜR FUSSBODENBRETTER - VIS D'ASSEMBLAGE DES LAMES DE PLANCHER 	915	4x60	
HS40	SCREW FOR 1. WALL BEAM - SCHRAUBE FÜR 1. BOHLENREIHE - VIS DE FIXATION DES FONDATIONS 	21	5x120	
HS42	SCREW FOR GABLE - SCHRAUBEN FÜR GIEBEL - VIS POUR FIXATION DES PIGNONS 	40	5x120	
HS43	SCREW FOR ROOF BEAMS - SCHRAUBEN FÜR DACHBALKEN - VIS POUR PANNE DE TOIT 	50	5x120	
HS39	SCREW FOR FUNDAMENT - SCHRAUBEN ZUR BEFESTIGUNG FUNDAMENT - VIS POUR FONDATION 	68	5x90	
NF3	SCREW FOR TERRACE BOARD - SCHRAUBE FÜR TERRASSENBRETT - VIS POUR LAME DE SEUIL D'ENTREE DE TERRASSE 	384	4.5x55	
MS	SCREW FOR DOORSTEP - SCHRAUBEN FÜR TÜRSCHWELLE - VIS DE FIXATION DU SEUIL DE PORTE 	6	4.5x65	
NFD	ZN NAIL FOR ROOFING FELT FILLET - ZN NÄGEL FÜR DACHPAPPENLEISTE - POINTE POUR BAGUETTE FIXATION FEUTRE BITUMEUX 	42	2x40	
NFF	ZN NAIL FOR FILLETS - ZN NÄGEL FÜR LEISTEN - POINTE POUR CORNIERE 	123	1.4x40	
NF2	ZN NAIL FOR ROOF - ZN NÄGEL FÜR DACHBRETTER - POINTE POUR TOIT 	1280	2x50	
ORZ	MONTAGE SET FOR DOORS AND WINDOWS - MONTAGE-SET FÜR TÜREN UND FENSTER - JEU DE MONTAGE PORTES ET FENETRES	1		
GS	GABLE SEGMENT-DECKBLATT - LOSANGE DE FINITION 	3		
SH70	HAMMER BLOCK - SCHLAGHOLZ - CALLE DE FRAPPE 	2		
2+ A.OP	WINDOW-FENSTER-FENETRE 916x916 	1		

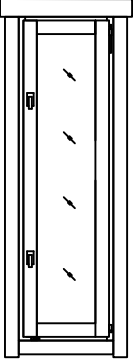
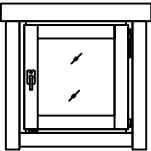
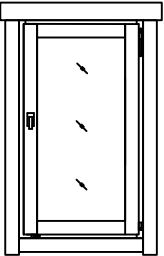
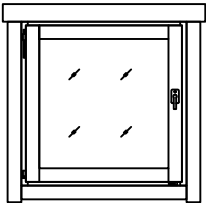
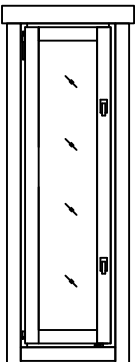
Pos	Columbia, Art.No.703241 Piece list - Stückliste - Liste des pieces	Q.	P (mm)	L (mm)
2+ A.0P.b	WINDOW-FENSTER-FENETRE 552x1729 	1		
2+ A.0P.c	WINDOW-FENSTER-FENETRE 650x650 Aken 610x610 	1		
2+ A.0P.d	WINDOW-FENSTER-FENETRE 702x1190 Aken 662x1150 	2		
2+ A.0V	WINDOW-FENSTER-FENETRE 916x916 Aken 876x876 	1		
2+ A.0V.b	WINDOW-FENSTER-FENETRE 552x1729 Aken 512x1689 	1		

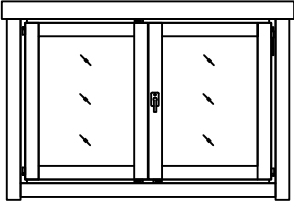
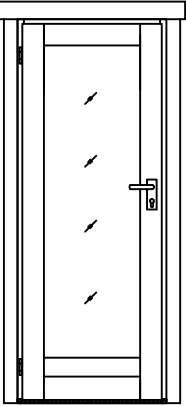
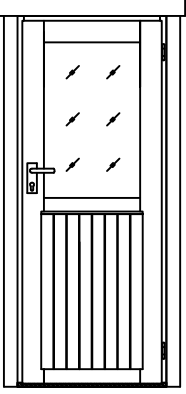
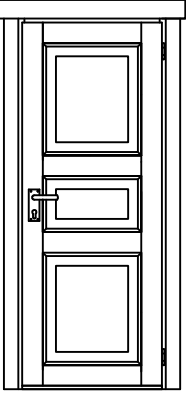
Pos	Columbia, Art.No.703241 Piece list - Stückliste - Liste des pieces	Q.	P (mm)	L (mm)
2+ T.A.0P	WINDOW-FENSTER-FENETRE 1374x916 	2		
2+ U.10V	DOOR-TÜR-PORTE 827x1933 	1		
2+ U.20P	DOOR-TÜR-PORTE 827x1933 	1		
U.3TP	DOOR-TÜR-PORTE 827x1933 	1		

