

*Bristol*  
Art. Nr. 4423502  
1/8

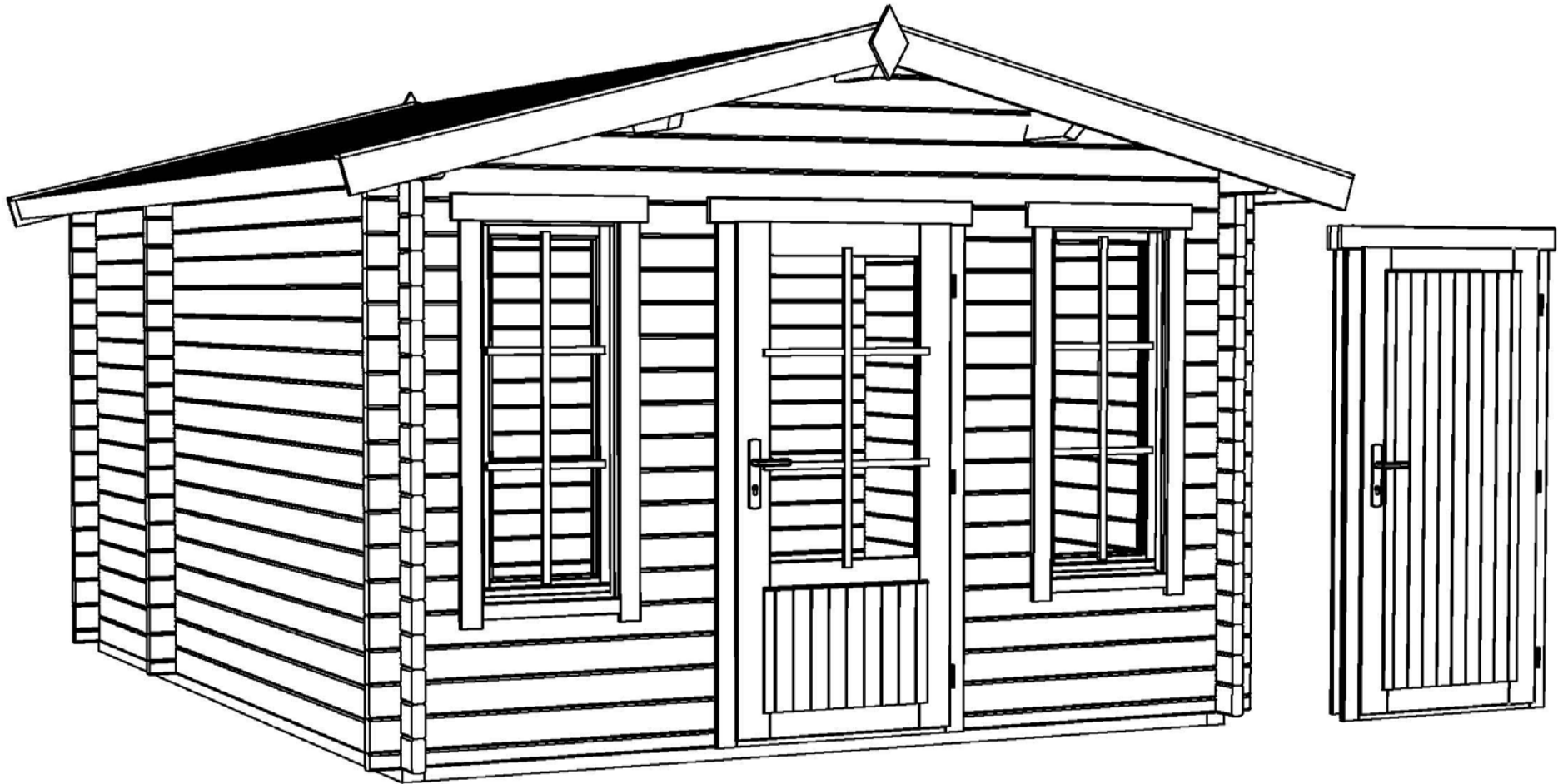

Groundplan - Grundplan - Plan de masse - Planimetria - Plattegrond - Põhiplaan

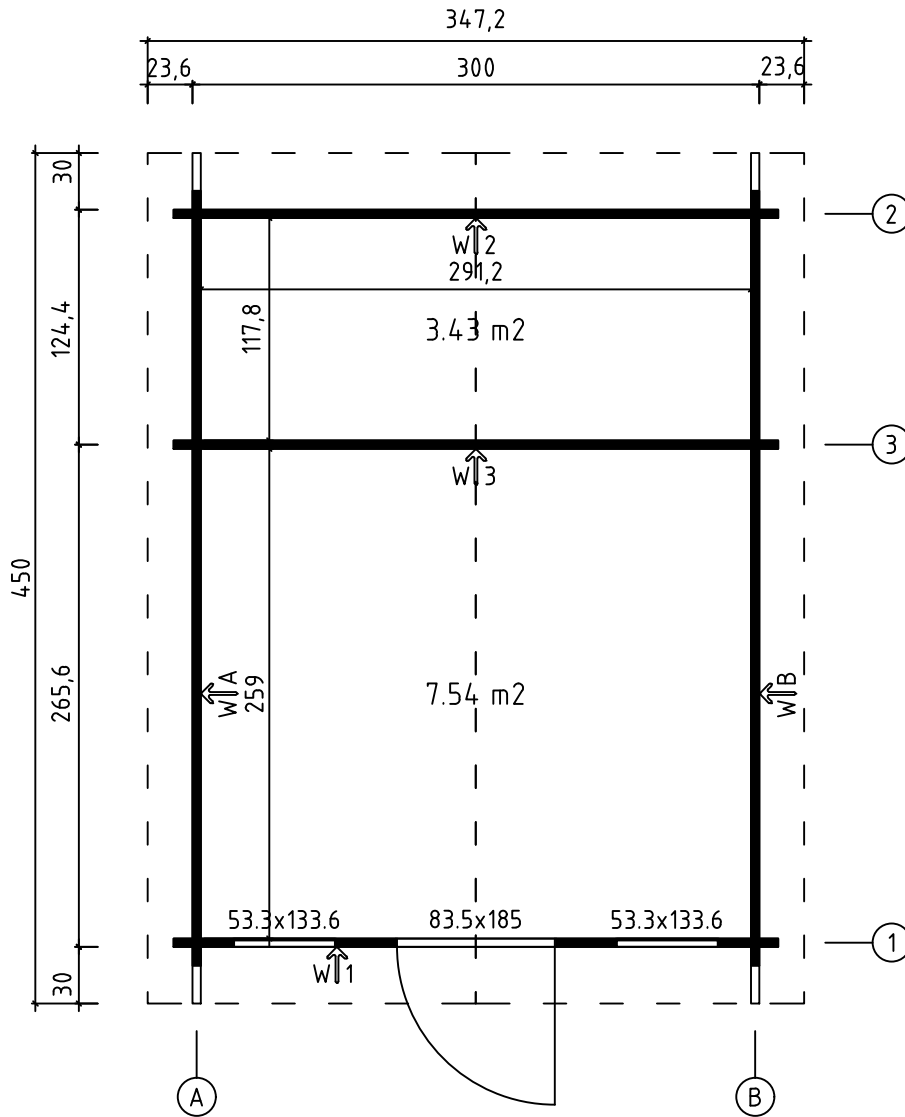

Art.Nr. 4423502

Foundation - Fundament - Fondation -  
Fondamenta -Fundering - Immutatud alusraam

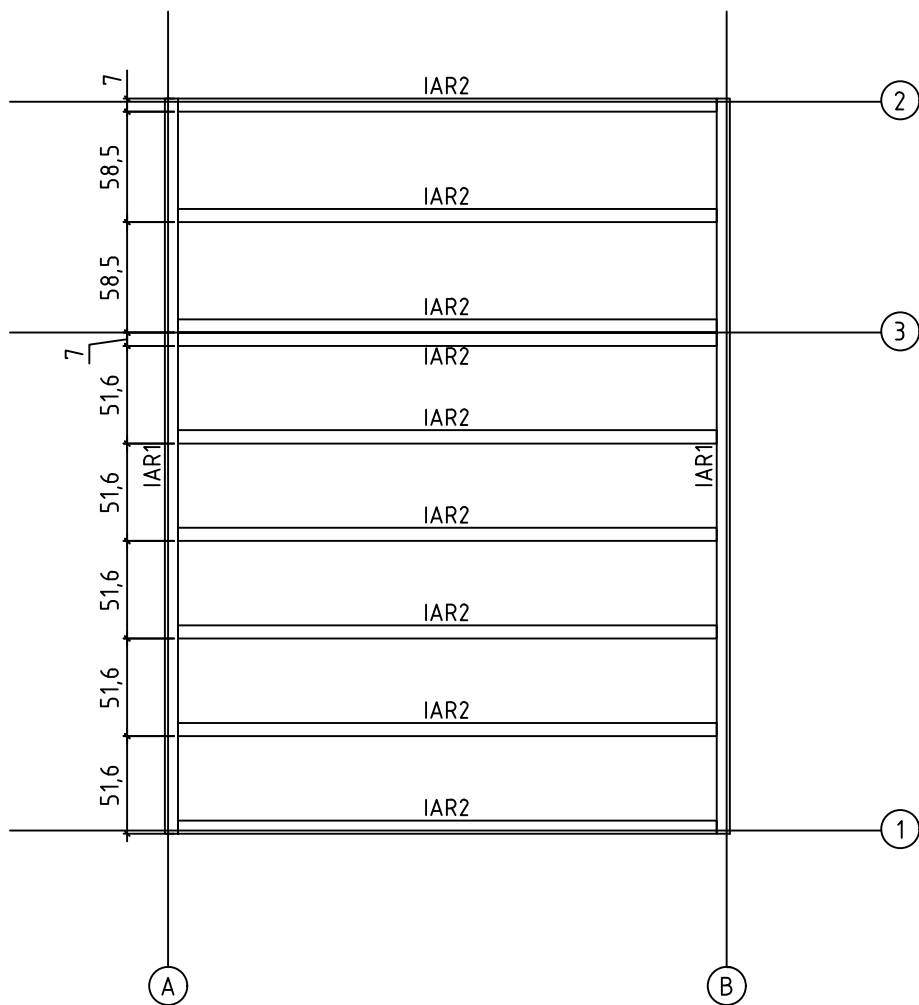

Floor boards - Fussbodenbretter - Plan pose plancher -  
Pavimento - Vloerhout - Põrandalaudis

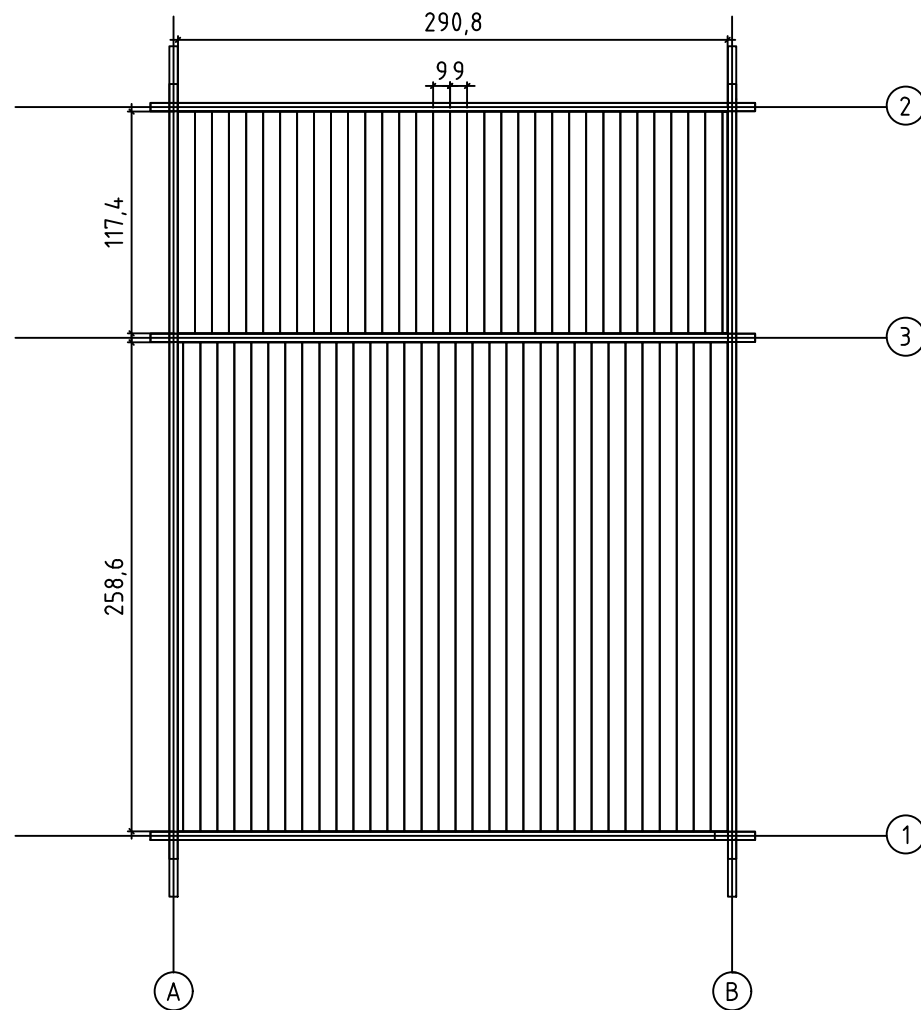

# Art.Nr. 4423502

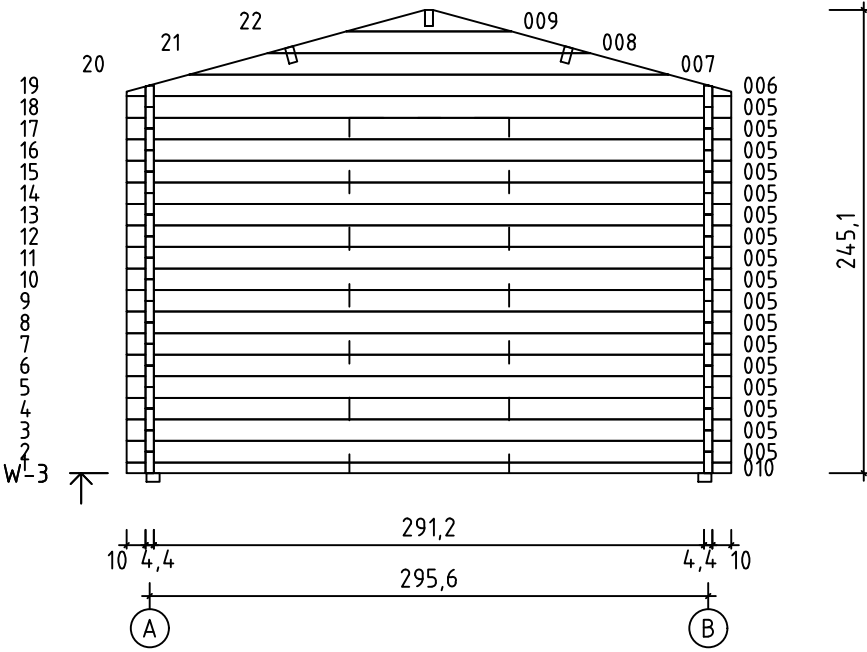
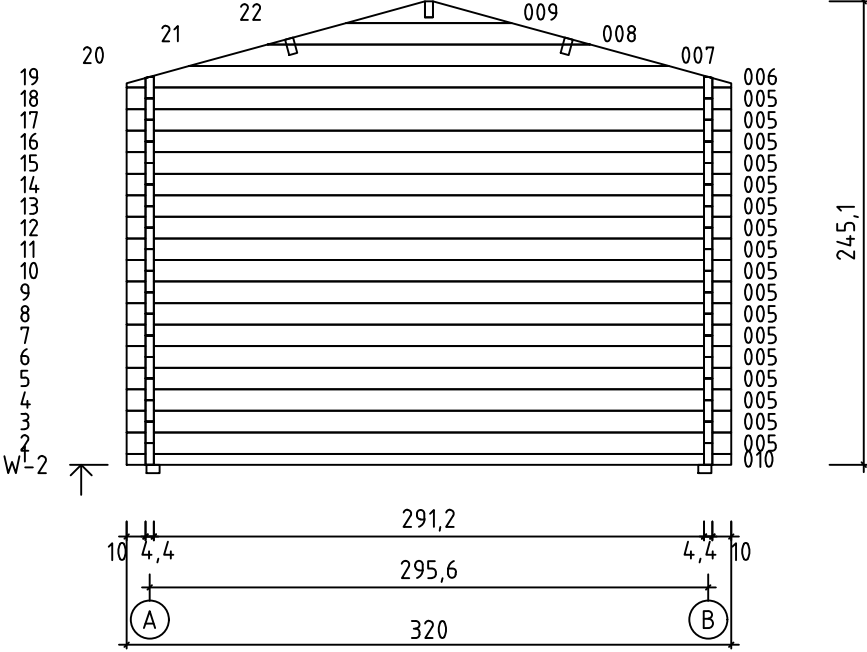
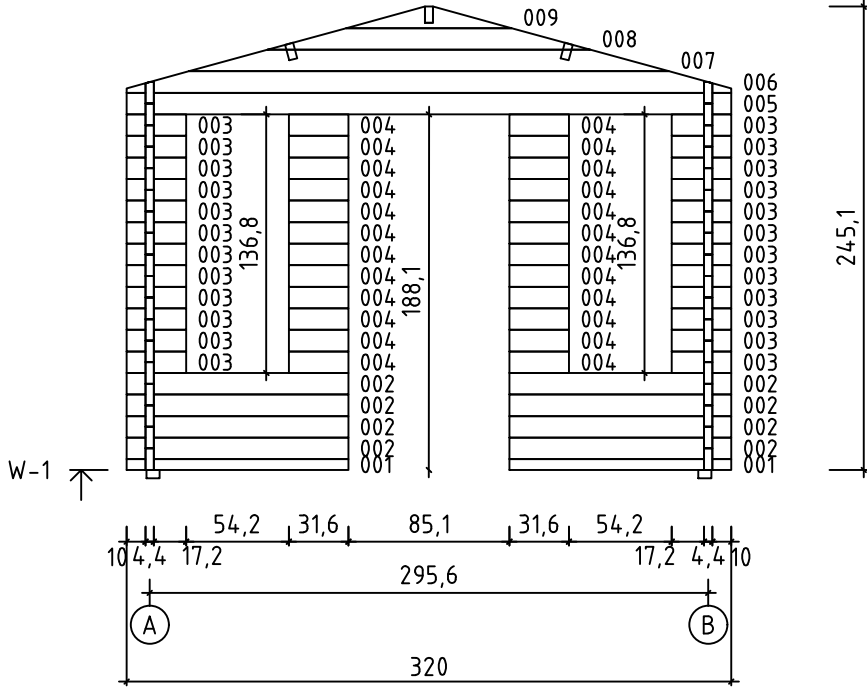

Art.Nr. 4423502

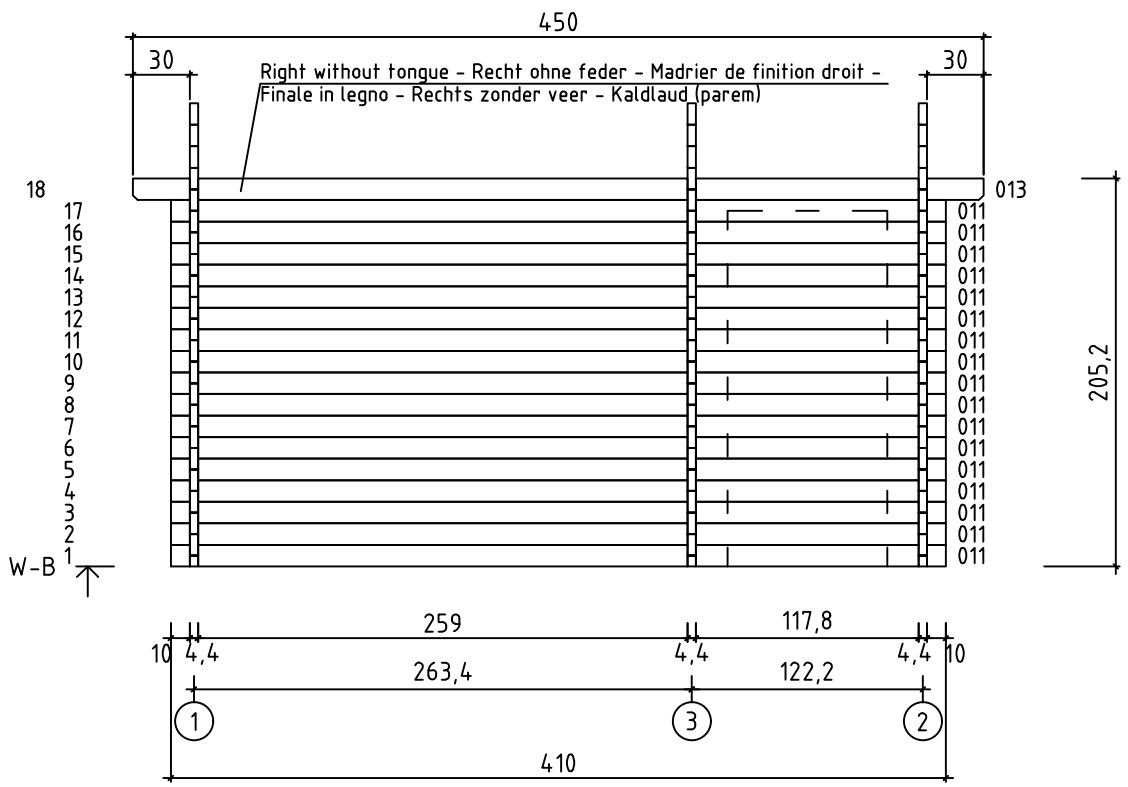
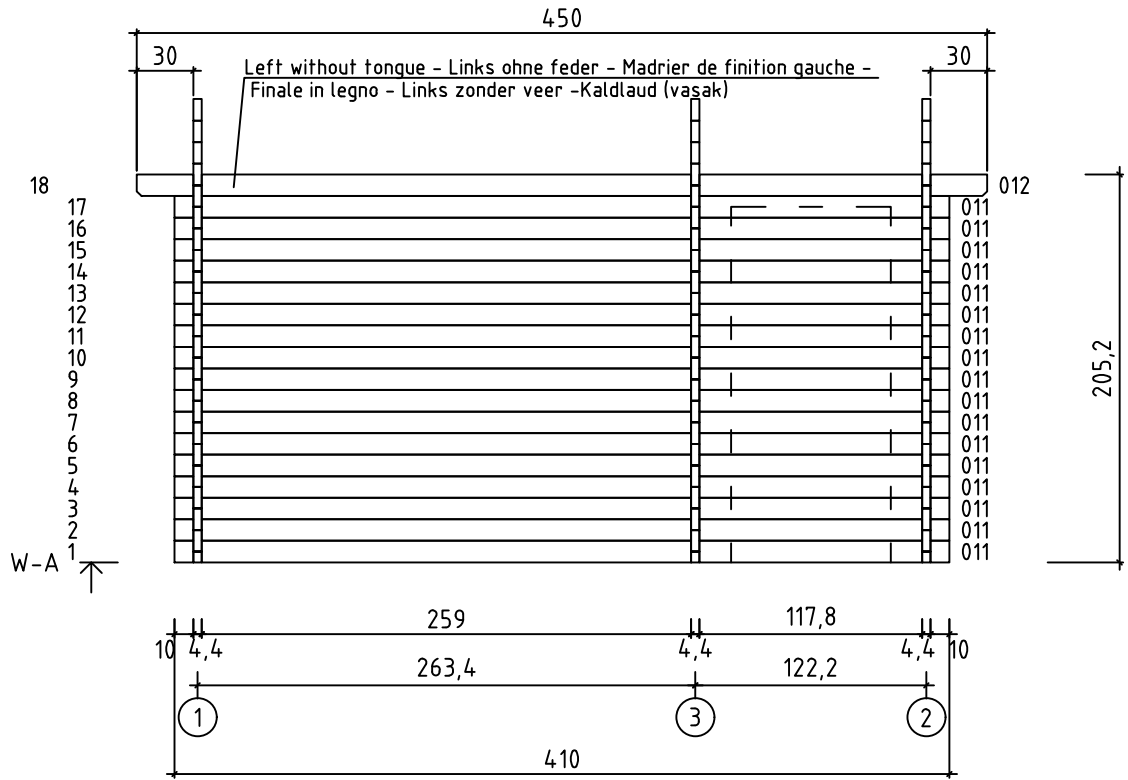

A single door (83.5x185 cm) has been delivered together with the building. You can choose the location for the door by yourself by cutting the wall logs as shown in the picture (see the dotted line).

Eine Einzeltür (83.5 x 185 cm) ist im Lieferumfang enthalten. Über die Positionierung der Tür entscheiden Sie selbst, indem Sie den Ausschnitt für die Tür in Eigenregie einschneiden (siehe Bild unter der gestrichelten Linie).









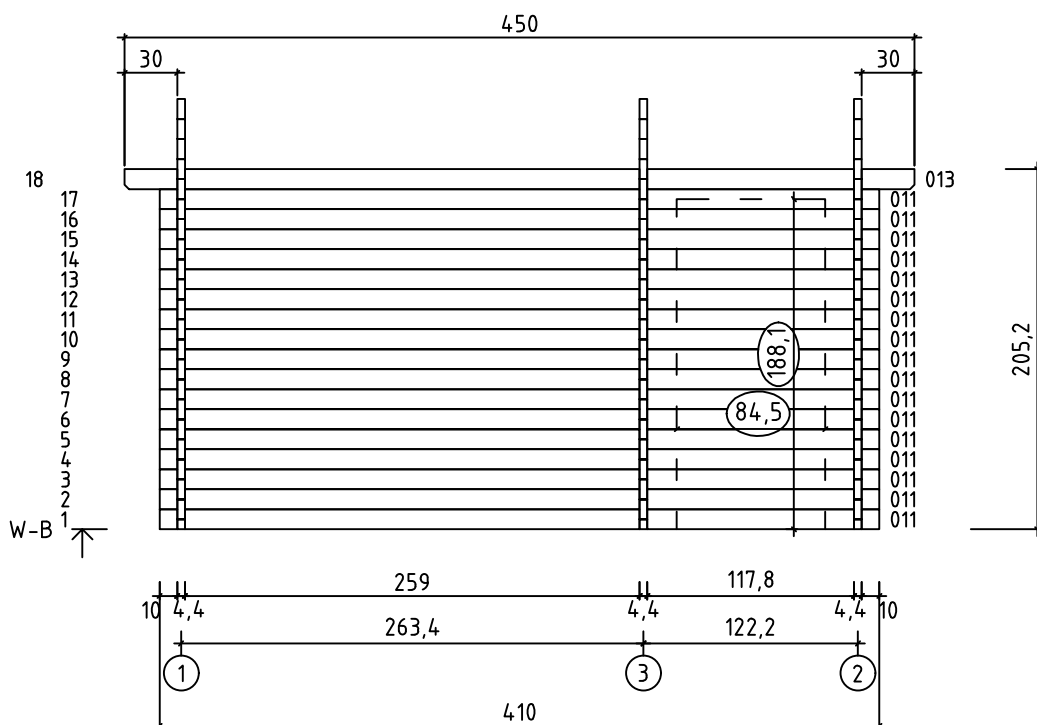

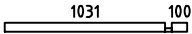
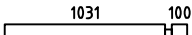

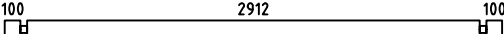
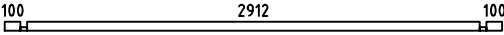
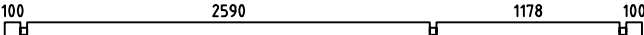
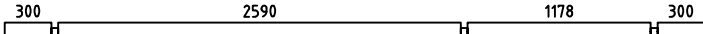
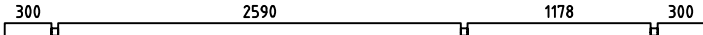
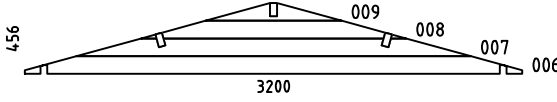
Une porte simple (83.5x185 cm) est livree avec l'abri. Vous pouvez choisir l'endroit ou vous voulez monter la porte en decoupant les madriers tel qu'illustre dans le schema (voir ligne en pointilles).

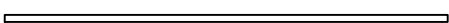
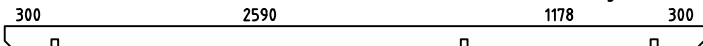





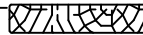

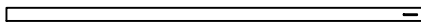
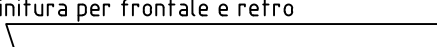

Una porta singola (83.5x185 cm) é stata consegnata con la casa. Tu puoi scegliere la posizione della porta secondo il tuo gradimento. tagliando la parete come raffigurato nella fotografia (segui la linea tratteggiata).

Bij uw huisje is een losse enkele deur (83.5x185 cm) geleverd. U heeft hierin een vrije keuze waar u deze wilt inbouwen, door het inzagen van de wandbalk zoals op de tekening (zie de stippellijn).

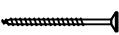
Majakomplekt sisaldab üksikut (83.5x185 cm), mille asukoht on võimalik ise valida. Ukseava tuleb lõigata joonisel näidatud mõõtudes (vaadake punktiirjooni).

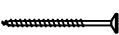
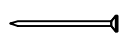

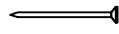
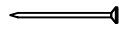
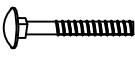





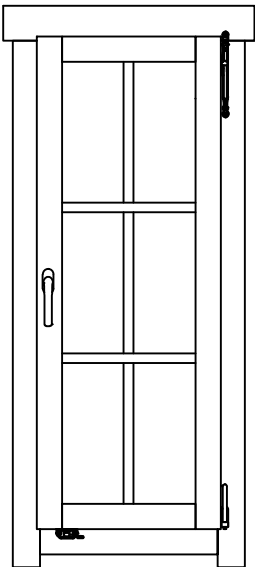
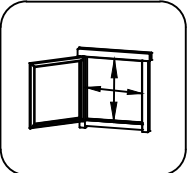
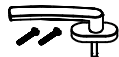
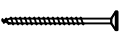

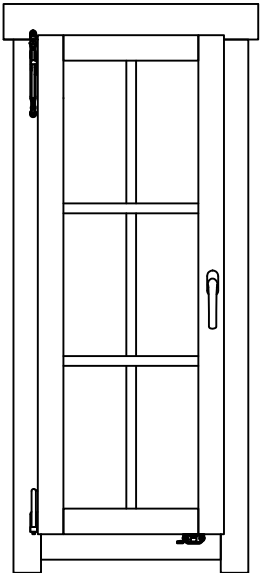
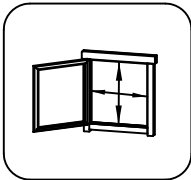
Pos	6.11.2018 Piece list - Stückliste - Liste des pièces - Elementi - Stuklijst - Tükitalabel Art.Nr. 4423502	7/8	Q	P (mm)	L (mm)
001			2	44x57	1175
002			8	44x114	1175
003			24	44x114	316
004			24	44x114	316
005			35	44x114	3200
010			2	44x57	3200
011			34	44x114	4100
012			1	44x120	4500
013			1	44x120	4500
W1-1 W2-1 W3-1			1 1 1		
IAR1	Foundation - Fundament - Fondation - Fondamenta - Fundering - Immutatud alusraam 		2	70x45	3890
IAR2	Foundation - Fundament - Fondation - Fondamenta - Fundering - Immutatud alusraam 		9	70x45	2850
A-PR1	Roof beam - Dachbalken - Panne de toit - Perlina del tetto - Gordingen / dakbalk - Pärilin 		3	44x140	4500
	Floor boards - Fussbodenbretter - Lamme de plancher - Pavimento - Vloerhout - Põrandalaud 		33	90x18	2586
	Floor boards - Fussbodenbretter - Lamme de plancher - Pavimento - Vloerhout - Põrandalaud 		33	90x18	1174
	Roof boards - Dachbretter - Voliges - Perlina per tetto - Dakhout - Katuselaud 		100	90x18	1800
	Floor fillet - Fussbodenleiste - Corniere de finition du plancher - Finitura per pavimento (battisco pa) - Vloerafwerklijst - Põrandaliist 			18x18	19.15
	Roofing felt fillet - Dachpappenleiste - Baguette de fixation du feutre bitumeux - Asse per fissaggio guaina bituminosa - Afdeklijst asfaltpapier - Katusepapiiist 		4	18x58	1850
TB-1	Fascia board - Traufbrett - Bandeau de toit - Finitura lati tetto - Gevellijst Räästalaud 		2	18x90	4500
DRV-1	Roof edge reinforcement - Dachrandverstärkung - Corniere de renfort de bord de toit - Rinforzo x tetto - Dakrand versterking - Räästatugevdus 		2	28x34	4500
KFS-1	Storm protection - Sturmleiste - Latte anti-tempete - Protezione anti vento - Stormverankering / beveliging - Tormikinnusliist 		4	22x45	2050
	Gable moulding - Giebelleiste - Planche de rive - Finitura per frontale e retro del tetto - Gevellijst - Viilulaud 		4	18x120	1850



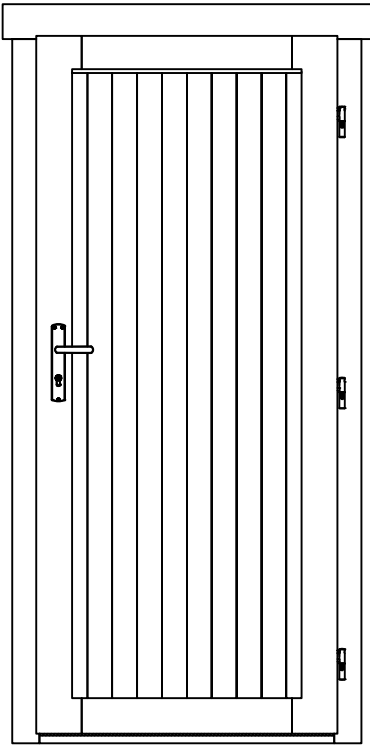
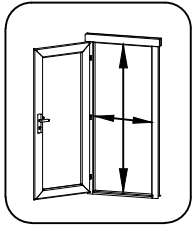
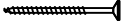

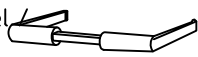

Pos	6.11.2018 Piece list - Stückliste - Liste des pièces - Elementi - Stuklijst - Tükítabel Art.Nr. 4423502	8/8	Q	P (mm)	L (mm)
HS8	Screw for gable segment - Schrauben für deckblatt - Vis pour fixation losange de finition - Viti x frontali tetto - Schroef voor gevelpunt segment - Kruvi rombile 		4	3.5x35	
HS9	Screw for gable moulding - Schrauben für giebelleiste - Vis pour fixation planche de rive - Vite per fissare finiture davanti e dietro del tetto - Schroef voor gevellijst - Kruvi viilulauale 		24	3.5x50	
HS12	Screw for fascia boards - Schrauben für traufbretter - Vis pour fixation bandeau de toit - Viti x striscia del tetto - Schroef voor gevellijst - Kruvi räästalauale 		20	4x40	
HS12	Screw for roof edge reinforcement - Schrauben für dachrandverstärkung - Vis pour fixation corniere renfort de bord de toit - Viti x rinforzo bordo tetto - Schroef voor dakrand versterking - Kruvi räästatugevdusele 		20	4x40	
HS18	Screw for 1. wall beam - Schraube für 1. bohlenreihe - Vis de fixations 1ere rangée de madriers avec poutrelles de fondations - Vite fissaggio alle fondamenta - Schroef voor 1 wandbalk - Kruvi poollauale 		10	5x120	
HS18	Screw for foundation - Schrauben zur befestigung fundament - Vis de fixations des poutrelles de fondations - Viti x fondamenta - Schroef voor fundering - Kruvi alusraamile 		18	5x120	
HS18	Screw for roof beams - Schrauben für dachbalken - Vis pour fixation pannes de toit - Viti per perline del tetto - Schroef voor gordingen / dakbalken - Kruvi pärlinitele 		6	5x120	
HS18	Screw for foundation - Schrauben zur befestigung fundament - Vis de fixations des poutrelles de fondations - Viti x fondamenta - Schroef voor fundering - Kruvi alusraamile 		2	5x120	
HS18	Screw for gable - Schrauben für giebel - Vis pour fixation des pignons - Viti per timpano - Schroef voor gevelpunt - Kruvi viilude kinnitamiseks 		6	5x120	
NF2	Zn nail for floor fillet - Zn nägel für fussbodenleiste - Pointe pour corniere de finition du plancher - Chiodi x fissaggio pavimento - Spijker(nagel) voor vloer afdekljst - Nael põrandaliistule 		39	1.4x40	
SH44	Hammer block - Schlagholz - Calle de frappe - Blocco di legno da usare come cuscinetto quando si usa il martello - Slagklos - Löögiklots 		1		
SFS	Nut for storm protection - Schraubenmutter für sturmleiste - Ecrou pour latte anti-tempete - Dado x asta protezione vento - Moer voor stromverankering - Mutter tormikinnusliistule 		8	D8	
NF4	Zn nail for roof - Zn nägel für dachbretter - Pointe pour fixation voliges de toit - Chiodi x perline tetto - Spijker(nagel) voor dakhout - Nael katuselauale 		318	2x50	
NF4	Zn nail for floor - Zn nägel für fussbodenbretter - Clous pour plancher - Chiodi x perline pavimento - Spijker(nagel) voor vloer - Nael põrandalauale 		306	2x50	
NF5	Zn nail for roofing felt fillet - Zn nägel für dachpappenleiste - Pointe pour baguette de fixation feutre bitumeux - Chiodi x carta bituminosa x tetto - Spijker(nagel) voor asfaltpapier afdekljst - Papiilistunael 		20	2x40	
BFS	Bolt for storm protection - Bolzen für sturmleiste - Boulon pour latte anti-tempete - Bullone x asta protezione vento - Bout voor stormankerlat - Puidupolt tormikinnusliistule 		8	8x80	
GS	Gable segment - Deckblatt - Losange de finition - Decorazione in legno x frontale tetto - Gevelpunt segment - Romb 		2		
DFS	Washer for storm protection - Dichtscheibe für sturmleiste - Rondelle pour latte anti-tempete - Rondella x asta protezione vento - Afdichtring voor storm strip - Seib tormikinnusliistule 		8	D8	
	Window - Fenster - Fenetre - Finestra - Raam - Aken	533x1336 AK.1.106.TPSP.g DGP+	1		
	Window - Fenster - Fenetre - Finestra - Raam - Aken	533x1336 AK.1.106.TPSV.g DGP+	1		
	Door - Tür - Porte - Porte - Deur - Uks	835x1850 UL.2.100.IVP.MMWa TP+	1		
	Door - Tür - Porte - Porte - Deur - Uks	835x1850 UK.2.066.TPVP.MMWa DGP+	1		

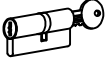

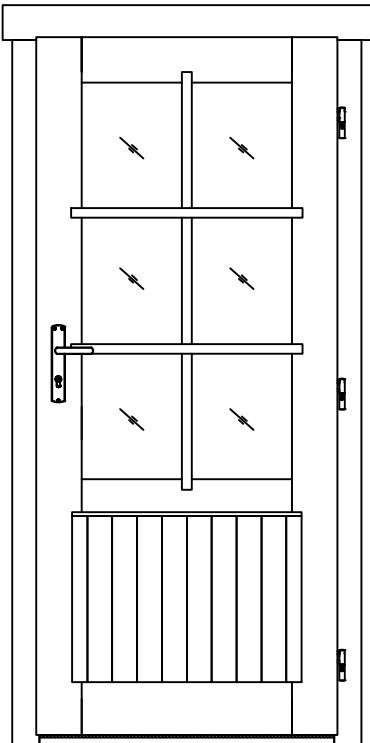
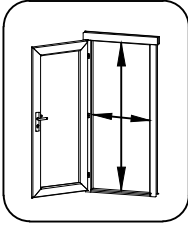
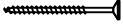
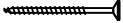
Pos	04.01.2018 Piece list - Stückliste - Liste des pièces - Elementi - Stuklijst - Tükítabel 533x1336 AK.1.106.TPSP.g DGP+	1/1	Q	P (mm)	L (mm)
	<p data-bbox="258 152 1284 183">Glass size - Glasgröße - Taille de la vitre - Misura del vetro - Glas afmeting - Klaasi mõõt: 363x1158 mm</p> <div data-bbox="726 241 981 806" style="text-align: center;">  </div> <div data-bbox="1337 152 1524 324" style="text-align: right;">  <p data-bbox="1364 347 1497 376">433x1240 mm</p> </div>				
FS2	<p data-bbox="258 2038 1021 2094">Window handle fittings - Fenstergriff - Poignée de fenetre - Maniglia c/ferramenta - Raamhendel -/grendel -/klink - Aknalink</p>		1		
HS1	<p data-bbox="258 2116 1109 2195">Screw for georgian bars - Schraube für sprossen - Vis pour croisillons - Viti per unire la griglia georgiana della finestra - Schroeven voor raamverdeling - Kruvi akna petfeliistule</p>		6	2.5x20	

Pos	04.05.2017 Piece list - Stückliste - Liste des pièces - Elementi - Stuklijst - Tükitabel 533x1336 AK.1.106.TPSV.g DGP+	1/1	Q	P (mm)	L (mm)
	<p data-bbox="193 136 1235 165">Glass size - Glasgröße - Taille de la vitre - Misura del vetro - Glas afmeting - Klaasi mõõt: 363x1158 mm</p>   <p data-bbox="1315 338 1442 367">433x1240 mm</p>				
FS2	<p data-bbox="193 2051 967 2107">Window handle fittings - Fenstergriff - Poignée de fenetre - Maniglia c/ferramenta - Raamhendel -/grendel -/klink - Aknalink</p>		1		
HS1	<p data-bbox="193 2130 1054 2208">Screw for georgian bars - Schraube für sprossen - Vis pour croisillons - Viti per unire la griglia georgiana della finestra - Schroeven voor raamverdeling - Kruvi akna petteliistule</p>		6	2.5x20	

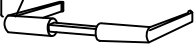
Pos	05.04.2016 Piece list - Stückliste - Liste des pièces - Elementi - Stuklijst - Tükítabel 835x1850 UL.2.100.IVP.MMWa TP+	1/1	Q	P (mm)	L (mm)
<div style="display: flex; justify-content: space-around; align-items: center;">   </div> <p style="text-align: right; margin-right: 100px;">735 x 1766 mm</p>					
HS16	Screw for door jamb - Schraube für türrahmen - Vis de fixation partie haute avec montants du cadre de porte - Viti x fissaggio montanti porte - Schroef voor deurkozijn - Kruvi ukse lengile		4	5x90	
HS25	Screw for doorstep - Schrauben für swelle - Vis pour fixation barre de seuil - Vite per soglia della porta - Schroef voor deurdorpel - Kruvi lävepakule		2	4.5x65	
HC	Covers for door hinges - Schutzkappe für türband - Couverture de paumelle de porte - Copertura delle cerniere della porta - Afdek kap voor deurscharnier - Reguleeritava polthinge kate		6		
MH	Male bolt hinge for door - Türband - Partie male de paumelle de porte - Cerniera anube x porta - Scharnier bout - Reguleeritav polthing isane		3	14x80	
TL4	Door handle fittings - Türgriff - Poignée de porte - Maniglie - Deurhendel klink - Ukse käepide		1		
TL5	Set of door lock covers - Schlossblenden - Set de garnitures de porte - Copertura serrature - Slot sluitplaat set - Ukse lukuplaat		1		
	Cylinder lock - Zylinderschloss - Barillet de porte - Serratura - Cylinder slot - Ukse lukusüdamik		1	30x35	

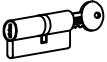
Pos	Piece list - Stückliste - Liste des pièces - Elementi - Stuklijst - Tükítabel 27.03.2018 835x1850 UK.2.066.TPVP.MMWa DGP+	1/1	Q	P (mm)	L (mm)
	<p>Glass size - Glasgröße - Taille de la vitre - Misura del vetro - Glas afmeting - Klaasi mõõt: 561x1041 mm</p>   <p>735x1768 mm</p>				
HS1	Screw for georgian bars - Schraube für sprossen - Vis pour croisillons - Viti per unire la griglia georgiana della finestra - Schroeven voor raamverdeling - Kruvi ukse petteliistule		6	2.5x20	
HS16	Screw for door jamb - Schraube für Türrahmen - Vis de fixation partie haute avec montants du cadre de porte - Viti x fissaggio montanti porte - Schroef voor deurkozijn - Kruvi ukse lengile		4	5x90	
HS25	Screw for doorstep - Schrauben für swelle - Vis pour fixation barre de seuil - Vite per soglia della porta - Schroef voor deurdorpel - Kruvi lävepakule		2	4.5x65	
MH	Male bolt hinge for door - Türband - Partie male de paumelle de porte - Cerniera anube x porta - Scharnier bout - Reguleeritav polthing isane		3	14x80	
HC	Covers for door hinges - Schutzkappe für Türband - Couverture de paumelle de porte - Copertura delle cerniere della porta - Afdek kap voor deurscharnier - Reguleeritava polthinge kate		6		
TL4	Door handle fittings - Türgriff - Poignée de porte - Maniglie - Deurhendel klink - Ukse käepide		1		
TL5	Set of door lock covers - Schlossblenden - Set de garnitures de porte - Copertura serrature - Slot sluitplaat set - Ukse lukuplaat		1		
	Cylinder lock - Zylinderschloss - Barillet de porte - Serratura - Cylinder slot - Ukse lukusüdamik		1	30x35	