

Brighton 44
Art. Nr. 4416902
1/10



9.03.2018

Art.Nr. 4416902

Groundplan - Grundplan - Plan de masse - Planimetria - Plattegrond - Põhiplaan

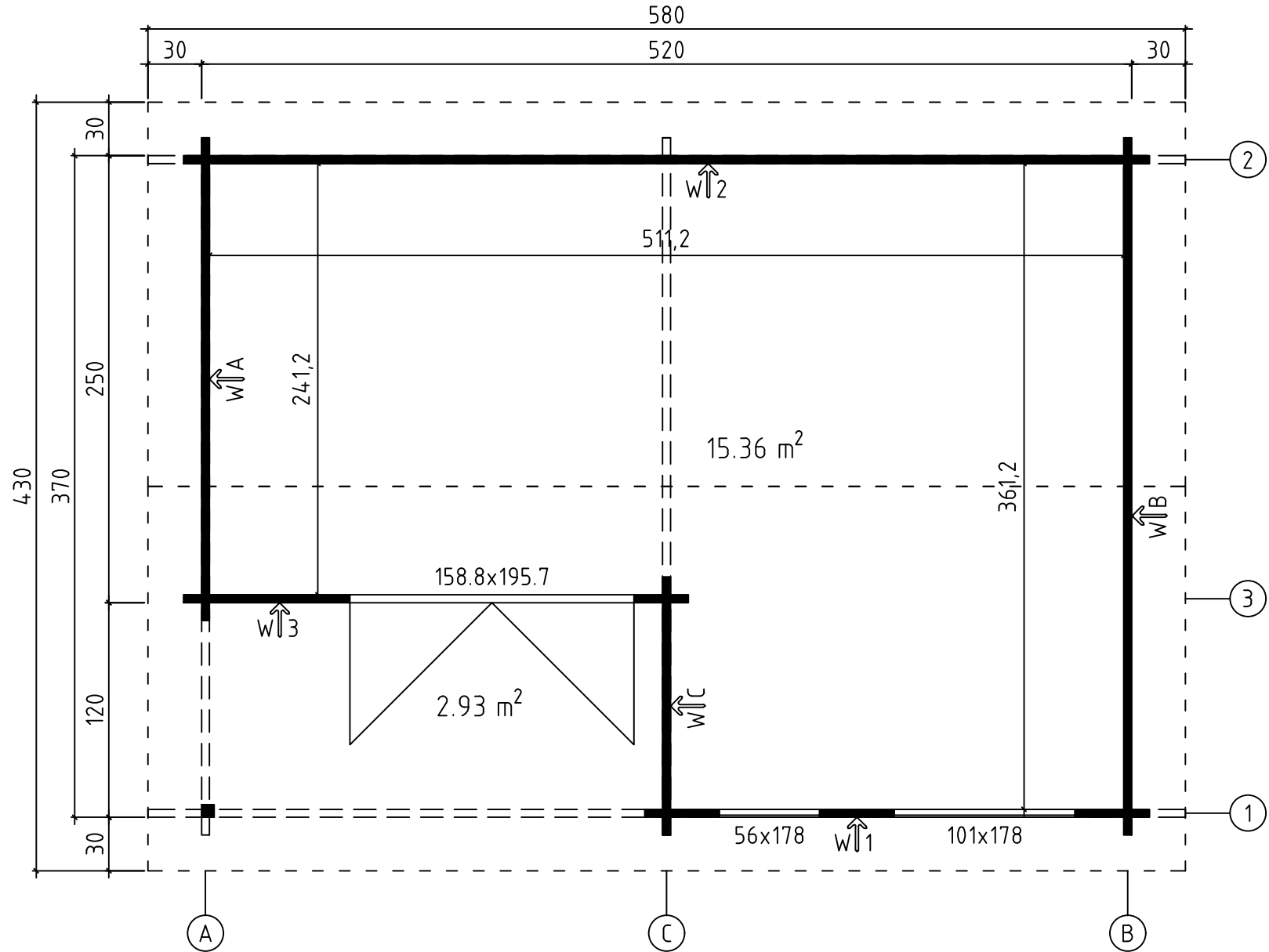

Foundation - Fundament - Fondation - Fondamenta - Fundering - Immutatud alusraam

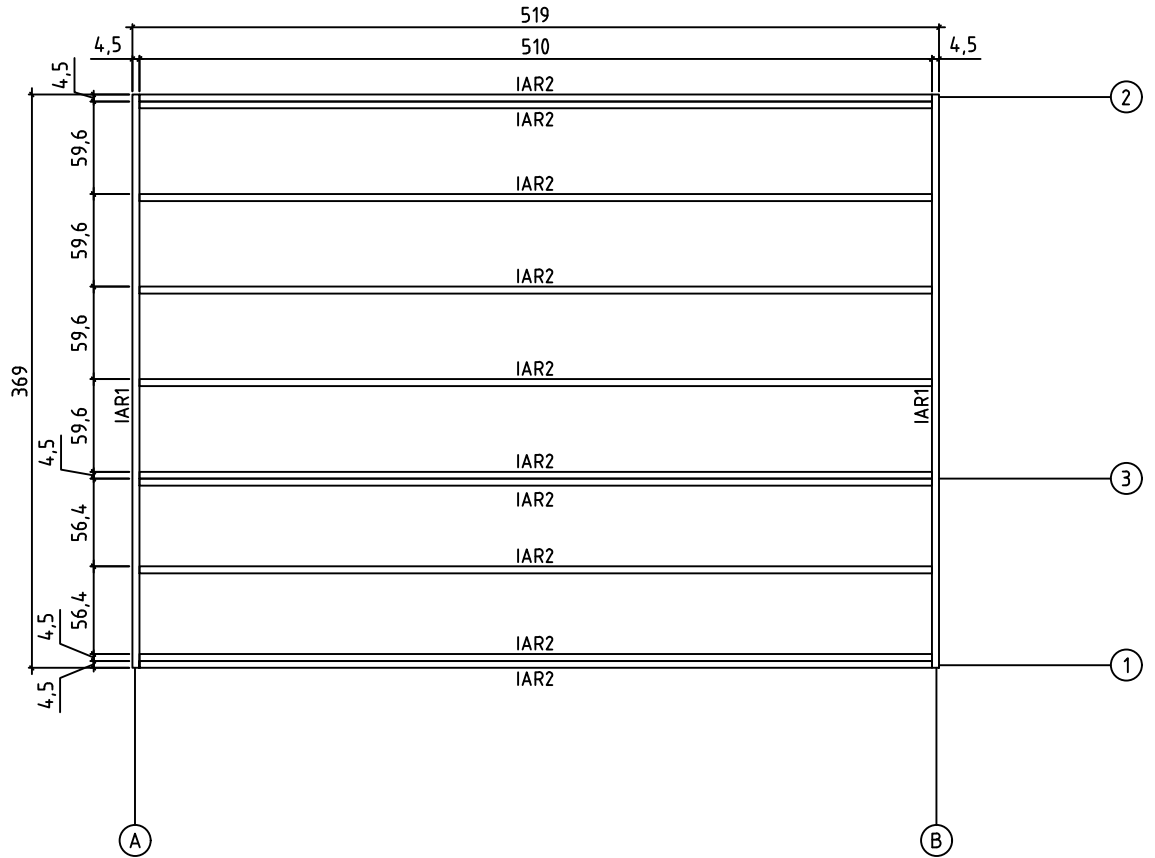

Floor boards - Fussbodenbretter - Plan pose plancher -
Pavimento - Vloerhout - Põrandalaudis

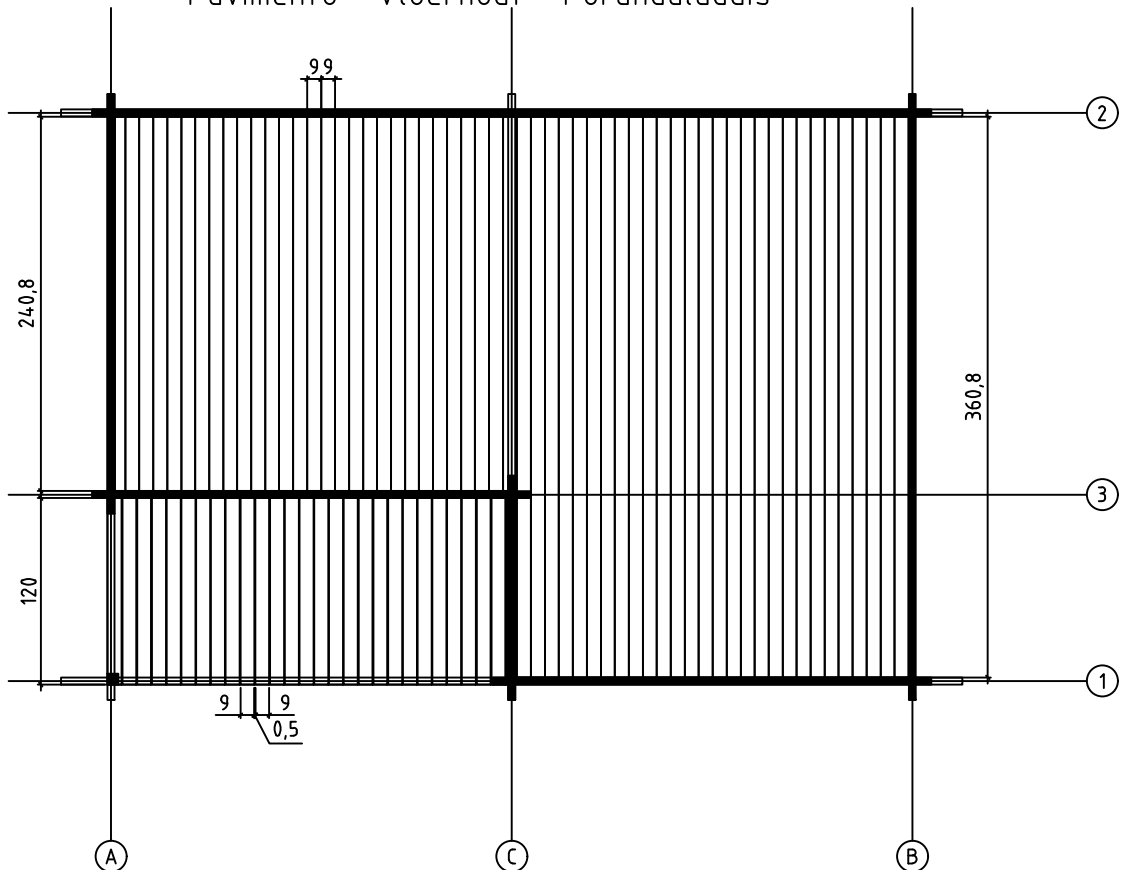

Terrace boards - Terrassenbretter - Plancher de terrasse -
Piattaforme terrazzo - Terrasyvloer - Terrassilaudis

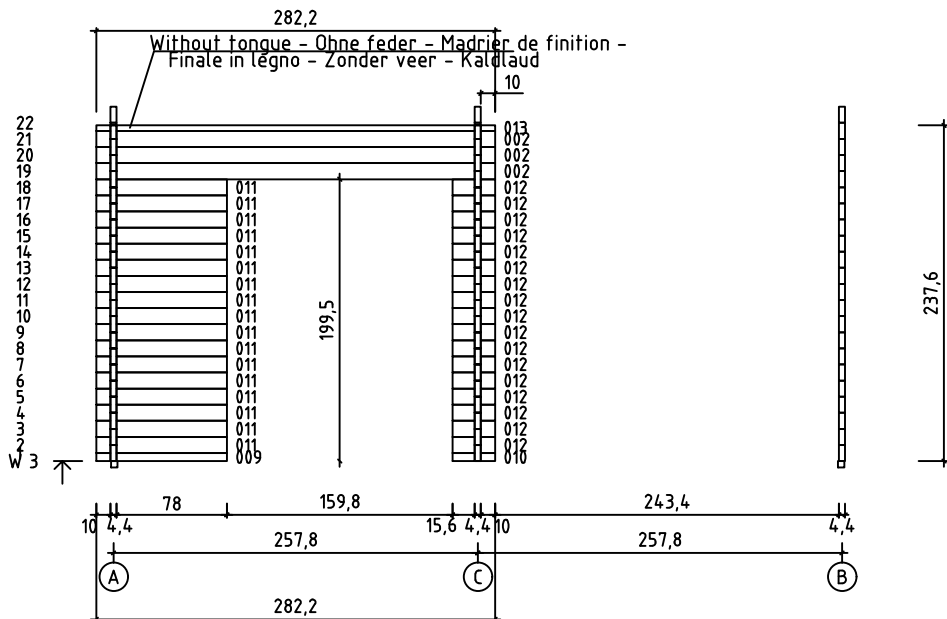
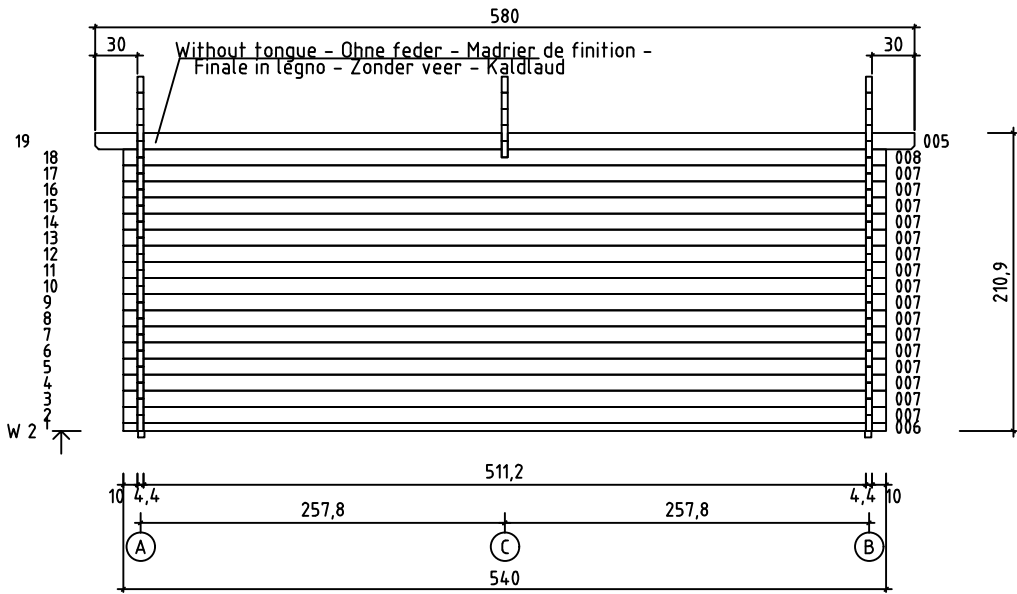
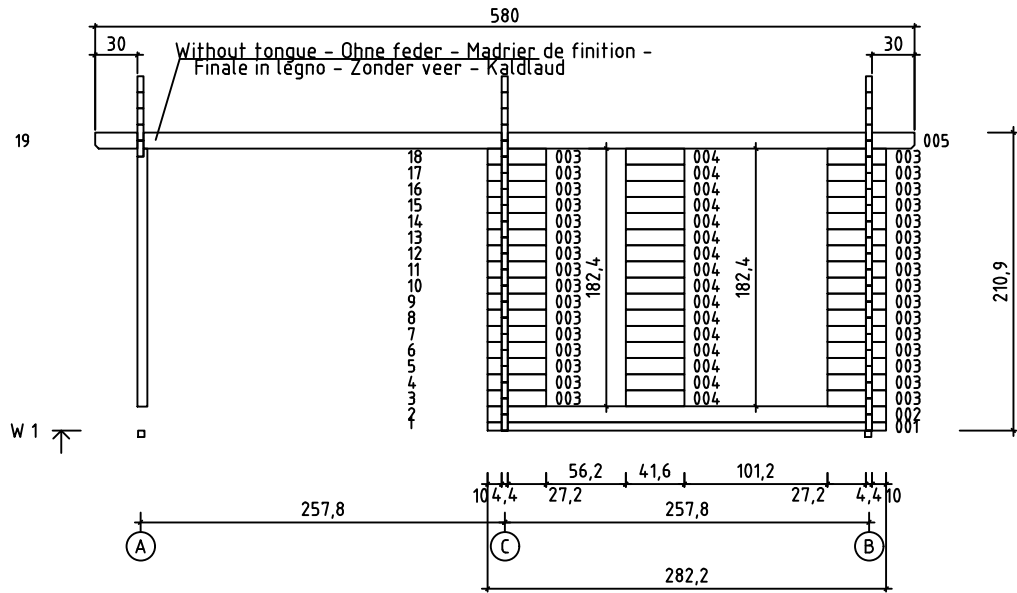

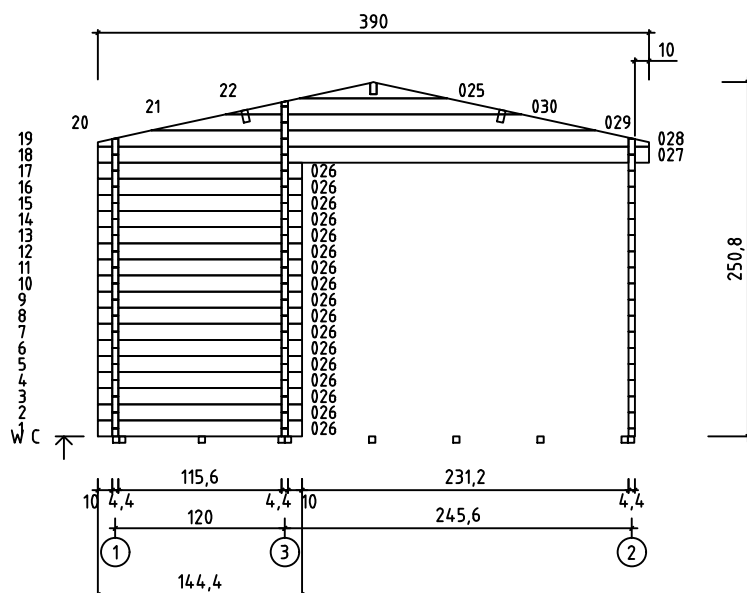
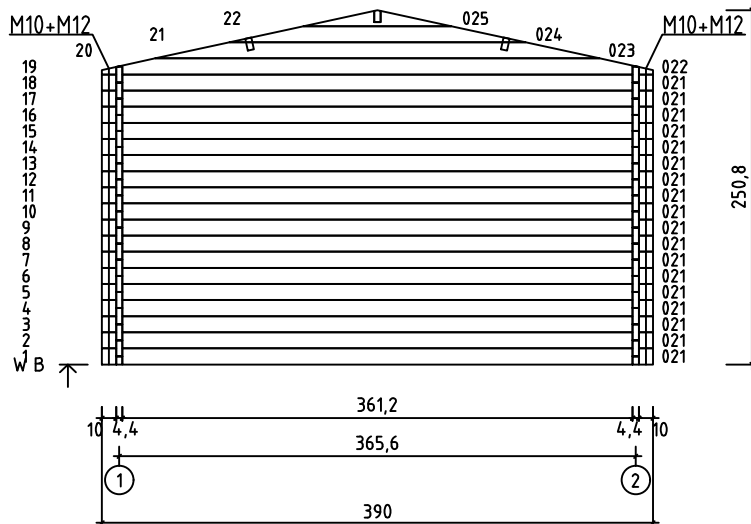
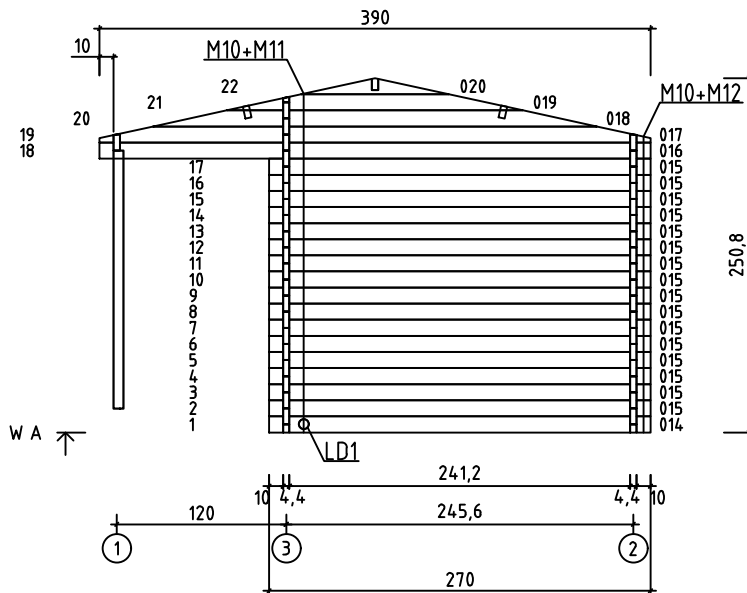

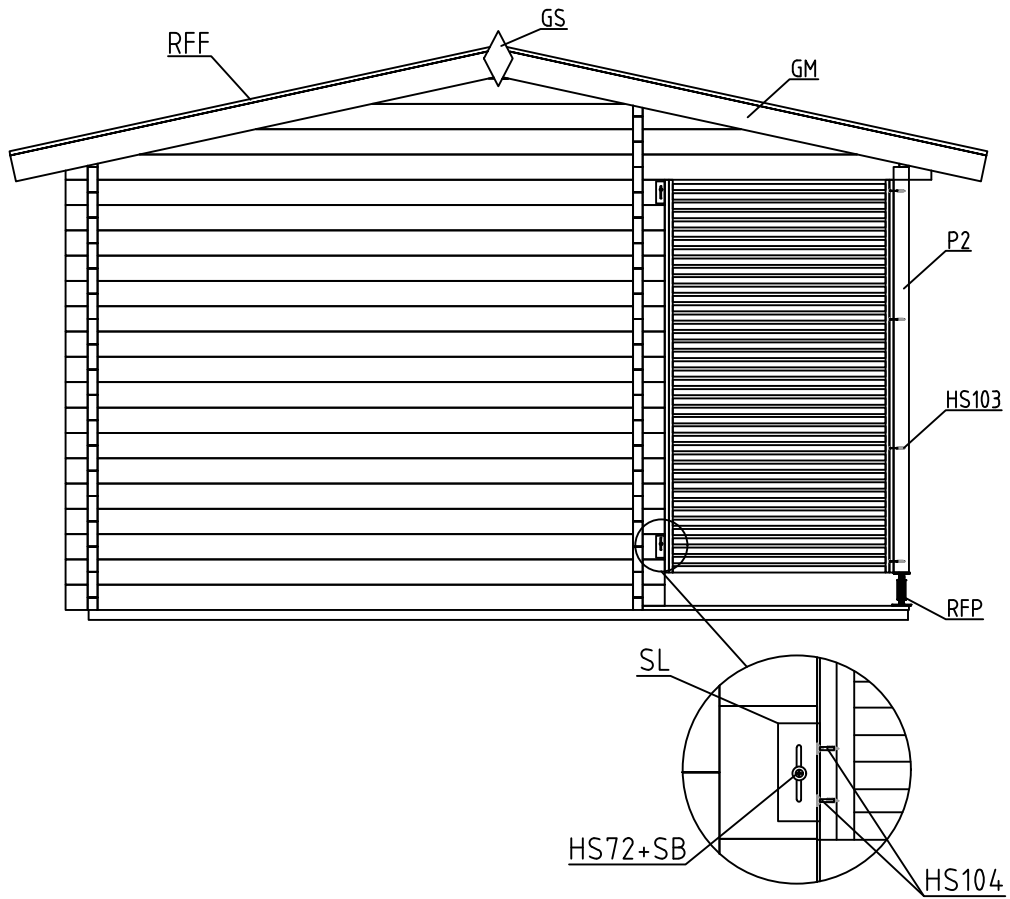



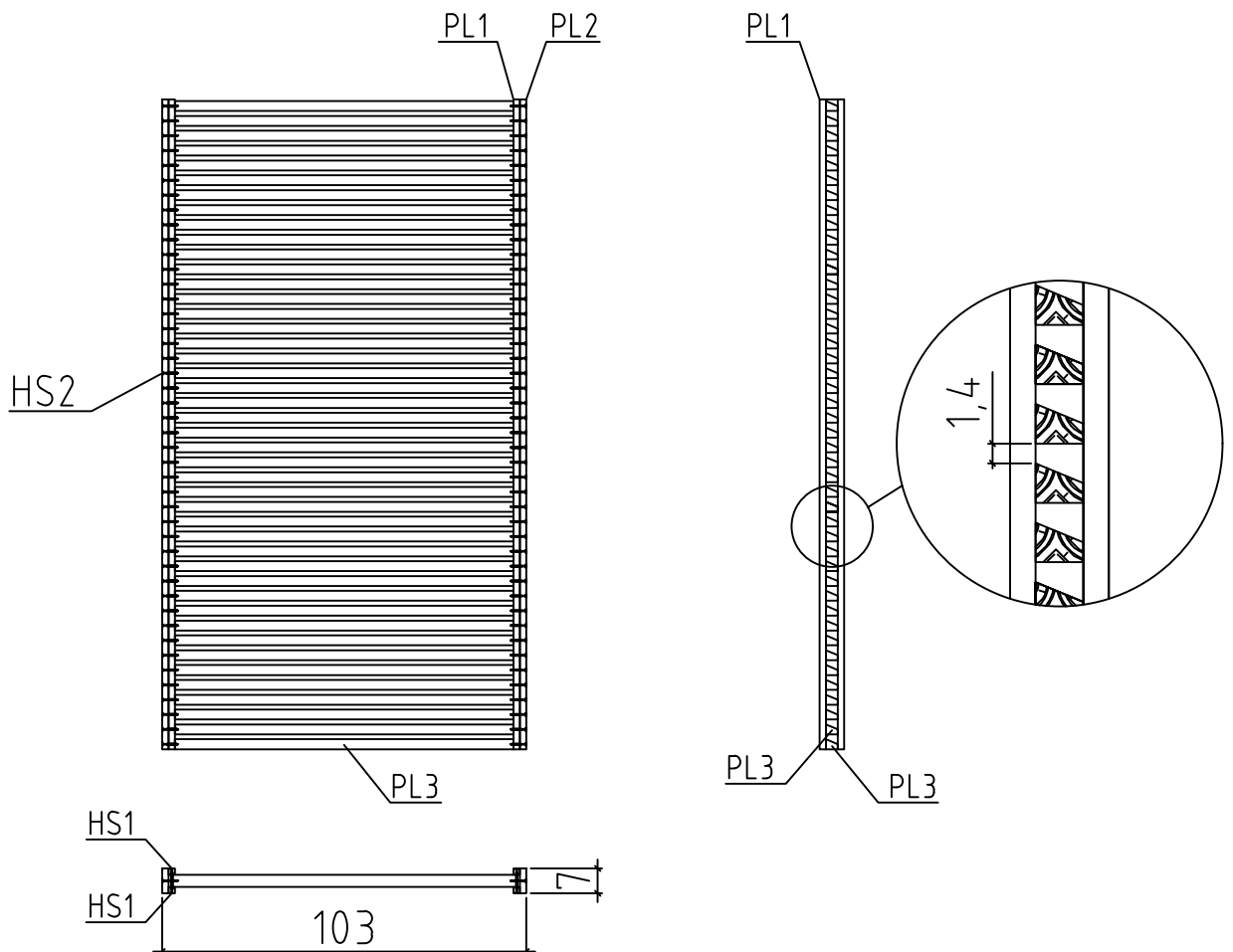

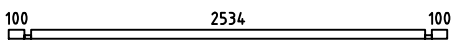
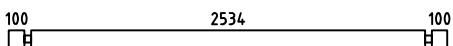

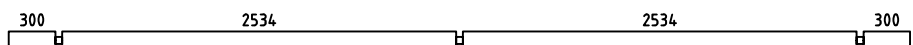
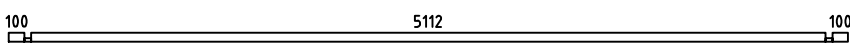
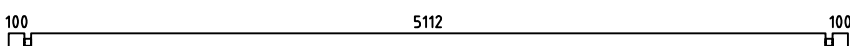
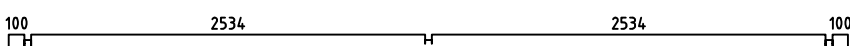
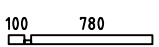

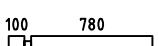

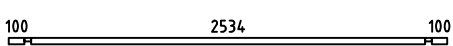
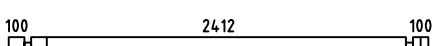
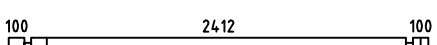
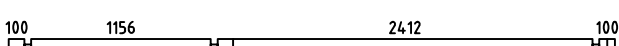
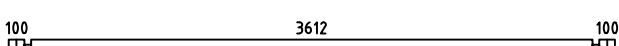
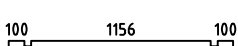
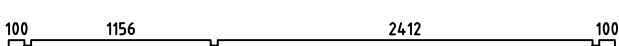
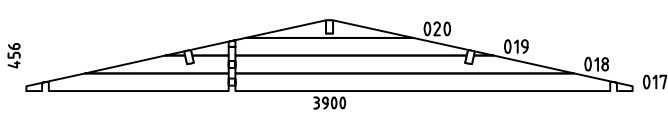
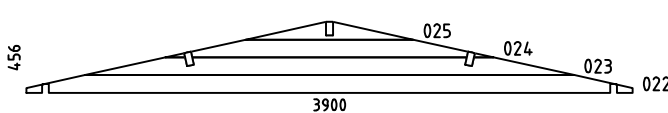







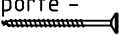
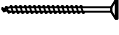
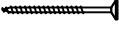

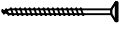
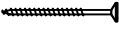
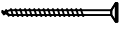
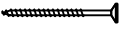

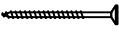

Terrace railing - Terrassenzaun - Garde-corps de terrasse -
 Ringhiera per terrazza - Terras rails (leuning) - Piiirdeaed

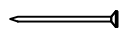
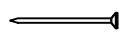
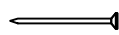

Pos	Piece list - Stückliste - Liste des pièces - Elementi - Stuklijst - Tükítabel 09.03.2018 Art.Nr. 4416902	7/10	Q	P (mm)	L (mm)
001			1	44x57	2822
002			4	44x114	2822
003			32	44x114	416
004			16	44x114	416
005			2	44x120	5800
006			1	44x57	5400
007			16	44x114	5400
008			1	44x114	5400
009			1	44x57	924
010			1	44x57	300
011			17	44x114	924
012			17	44x114	300
013			1	44x42	2822
014			1	44x114	2700
015			16	44x114	2700
016			1	44x114	3900
021			18	44x114	3900
026			17	44x114	1444
027			1	44x114	3900
WA-1			1		
WB-1			1		

Pos	Piece list - Stückliste - Liste des pièces - Elementi - Stuklijst - Tükitalabel 09.03.2018 Art.Nr. 4416902	8/10	Q	P (mm)	L (mm)
WC-1			1		
IAR2	Foundation - Fundament - Fondation - Fondamenta - Fundering - Immutatud alusraam 		10	45x45	5100
IAR1	Foundation - Fundament - Fondation - Fondamenta - Fundering - Immutatud alusraam 		2	45x45	3690
A-PR1	Roof beam - Dachbalken - Panne de toit - Perlina del tetto - Gordingen / dakbalk - Pärilin 		3	44x140	5800
	Floor boards - Fussbodenbretter - Lame de plancher - Pavimento - Vloerhout - Põrandalaud		29	90x18	3608
	Floor boards - Fussbodenbretter - Lame de plancher - Pavimento - Vloerhout - Põrandalaud		28	90x18	2408
	Terrace boards - Terrassenbretter - Plancher de terrasse - Piattaforme terrazzo - Terrasvloer - Terrasilaud		28	90x19	1200
DB	Roof boards - Dachbretter - Voliges - Perlina per tetto - Dakhout - Katuselaud		130	90x18	2200
	Floor fillet - Fussbodenleiste - Corniere de finition du plancher - Finitura per pavimento (battisco pa) - Vloerafwerkljst - Põrandaliist			18x18	17.43
RFF	Roofing felt fillet - Dachpappenleiste - Baguette de fixation du feutre bitumeux - Asse per fissaggio guaina bituminosa - Afdekljst asfaltpapier - Katusepapiilist		4	18x58	2250
M12	Treaded rod m10 - Gewindestange m10 - Tige filetée m10 - Barra filettata passo m10 - Draadstang 10m - Keermelatt		3		125
M11	Treaded rod m10 - Gewindestange m10 - Tige filetée m10 - Barra filettata passo m10 - Draadstang 10m - Keermelatt		1		340
M10	Treaded rod m10 - Gewindestange m10 - Tige filetée m10 - Barra filettata passo m10 - Draadstang 10m - Keermelatt		4		2000
PL1	Fillet for terrace railing - Leiste für terrasse - Baguette pour corps de terrasse - Massellino di guarnizione per ringhiera - Terras lijst - Päärde liist		4	18x18	1769
PL2	Fillet for terrace railing - Leiste für terrasse - Baguette pour corps de terrasse - Massellino di guarnizione per ringhiera - Terras lijst - Päärde liist		2	18x70	1769
PL3	Fillet for terrace railing - Leiste für terrasse - Baguette pour corps de terrasse - Massellino di guarnizione per ringhiera - Terras lijst - Päärde liist		42	28x34	994
P2	Post - Pfosten - Poteau - Piede registrabile - Stijl - Post 		1	70x70	1826
TB-1	Fascia board - Traufbrett - Bandeau de toit - Finitura lati tetto - Gevellijst Räästalaud		4	18x90	2900
DRV-1	Roof edge reinforcement - Dachrandverstärkung - Corniere de renfort de bord de toit - Rinforzo x tetto - Dakrand versterking - Räästatugevdus		4	28x34	2900
GM	Gable moulding - Giebelleiste - Planche de rive - Finitura per frontale e retro del tetto - Gevellijst - Viilulaud		4	18x120	2250
LD1	Lid for treaded rod hole - Abdeckung für gewindestangenöffnung - Couvercle pour acces réglagé tige filetée - Copeerchio per foro barra filettata - Afdekprofiel voor draadstang - Kaas keermelati avale		1		
	Lengthening bolt for treaded rod - Verlängerungsmutter für gewindestange - Manchon de raccordement de tige filetée - Bullone per barra filettata passo - Extensie moer voor draadstang - Keermelati jätkumutter		4	D10	

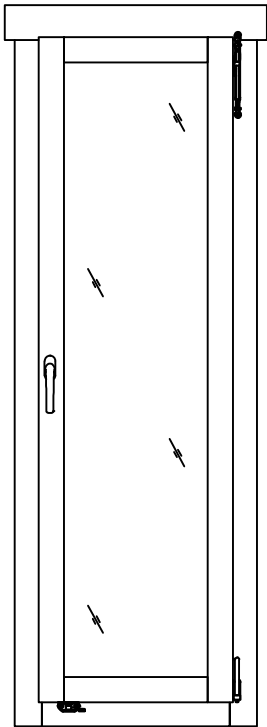
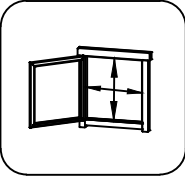
Pos	Piece list - Stückliste - Liste des pièces - Elementi - Stuklijst - Tükítabel 09.03.2018 Art.Nr. 4416902	9/10	Q	P (mm)	L (mm)
HS104	Screw for sliding wall tie - Schieberegler für wand - Sabot métallique pour fixation mur - Vite per fissare scorrimento a c su slitta fissata alla parete - Schuifdeur instellingen wand - Kruvi seinaliugurile		8	3.5x20	
HS8	Screw for gable segment - Schrauben für deckblatt - Vis pour fixation losange de finition - Viti x frontali tetto - Schroef voor gevelpunt segment - Kruvi rombile		4	3.5x35	
HS9	Screw for gable moulding - Schrauben für giebelleiste - Vis pour fixation planche de rive - Vite per fissare finiture davanti e dietro del tetto - Schroef voor gevellijst - Kruvi viilulauale		24	3.5x50	
HS1	Screw for covering moulding - Schrauben für deckungsprofil - Vis de fixation profils horizontaux haut intérieur et extérieur d'encadrement de porte - Vite per cornice di copertura - Schroef voor afdekprofiel - Kruvi piirdelauale		20	3x30	
HS103	Screw for fixing terrace railing - Schraube für terrasse - Vis de fixation de garde-corps de terrasse - Vite per fissaggio della ringhiera al terrazzo - Schroef voor terras - Kruvi piirdeaia kinnituseks		4	4.5x80	
HS2	Screw for covering moulding - Schrauben für deckungsprofil - Vis de fixation profils horizontaux haut intérieur et extérieur d'encadrement de porte - Vite per cornice di copertura - Schroef voor afdekprofiel - Kruvi piirdelauale		88	4x40	
HS12	Screw for fascia boards - Schrauben für traufbretter - Vis pour fixation bandeau de toit - Viti x striscia del tetto - Schroef voor gevellijst - Kruvi räästalauale		28	4x40	
HS12	Screw for roof edge reinforcement - Schrauben für dachrandverstärkung - Vis pour fixation corniere renfort de bord de toit - Viti x rinforzo bordo tetto - Schroef voor dakrand versterking - Kruvi räästatugevdusele		28	4x40	
HS13	Screw for post - Schrauben für pfosten - Vis de fixation des poteaux - Viti per inviare - Schroef voor stijlen - Kruvi postile		2	4x60	
HS18	Screw for roof beams - Schrauben für dachbalken - Vis pour fixation pannes de toit - Viti per perline del tetto - Schroef voor gordingen / dakbalken - Kruvi pärlinitele		17	5x120	
HS18	Screw for gable - Schrauben für giebel - Vis pour fixation des pignons - Viti per timpano - Schroef voor gevelpunt - Kruvi viilude kinnitamiseks		16	5x120	
HS16	Screw for 1. wall beam - Schraube für 1. bohlenreihe - Vis de fixations 1ere rangée de madriers avec poutrelles de fondations - Vite fissaggio alle fondamenta - Schroef voor 1 wandbalk - Kruvi poollauale		10	5x90	
HS16	Screw for foundation - Schrauben zur befestigung fundament - Vis de fixations des poutrelles de fondations - Viti x fondamenta - Schroef voor fundering - Kruvi alusraamile		32	5x90	
HS72	Screw for sliding wall tie - Schieberegler für wand - Sabot métallique pour fixation mur - Vite per fissare scorrimento a c su slitta fissata alla parete - Schuifdeur instellingen wand - Kruvi seinaliugurile		2	6x40	
HS20	Screw for post height adjustment - Schrauben für regulierungsschraube für pfosten - Vis de fixation de support réglable de poteau - Viti per fissare ed aggiustare l'altezza del palo verticale - Schroef voor hoogte instelling stijlen - Kruvi vajumisplidile		8	6x50	
NF2	Zn nail for floor fillet - Zn nagel für fussbodenleiste - Pointe pour corniere de finition du plancher - Chiodi x fissaggio pavimento - Spijker(nagel) voor vloer afdekljst - Nael põrandaliistule		35	1.4x40	
SH44	Hammer block - Schlagholz - Calle de frappe - Blocco di legno da usare come cuscinetto quando si usa il martello - Slagklos - Löögiklots		1		
SFS	Drive nut treaded rod - Einschlagmutter für gewindestange - Écrou a frapper pour tige filetée - Dado guida per barra filettata - Aandrijfmoer / aanslagmoer voor draadstang - Löökmutter keermelatile		4	D10	
SFS	Nut for treaded rod - Mutter für gewindestange - Écrou pour tige filetée - Dado per barra filettata - Moer voor draadstang - Mutter keermelatil		4	D10	
NF3	Zn nail for terrace - Zn nagel für terrassenbretter - Pointe pour plancher de terrasse - Chiodo zincato per terrazza - Spijker(nagel) voor terrasvloer - Nael terrasilauale		168	2.1x50	
NF4	Zn nail for roof - Zn nagel für dachbretter - Pointe pour fixation voliges de toit - Chiodi x perline tetto - Spijker(nagel) voor dakhout - Nael katuselauale		404	2x50	
NF4	Zn nail for floor - Zn nagel für fussbodenbretter - Clous pour plancher - Chiodi x perline pavimento - Spijker(nagel) voor vloer - Nael põrandalauale		350	2x50	
NF5	Zn nail for roofing felt fillet - Zn nagel für dachpappenleiste - Pointe pour baguette de fixation feutre bitumeux - Chiodi x carta bituminosa x tetto - Spijker(nagel) voor asfaltpapier afdekljst - Papiliistunael		24	2x40	

Pos	10.11.2017 Piece list - Stückliste - Liste des pièces - Elementi - Stuklijst - Tükitalabel 560x1780 AK.1.100.TPSP DGP+	1/1	Q	P (mm)	L (mm)
	<p data-bbox="256 152 1289 183">Glass size - Glasgröße - Taille de la vitre - Misura del vetro - Glas afmeting - Klaasi mõõt: 390x1602 mm</p>   <p data-bbox="1362 349 1497 380">460x1684 mm</p>				
FS2	<p data-bbox="261 2130 1023 2186">Window handle fittings - Fenstergriff - Poignee de fenetre - Maniglia c/ferramenta - Raamhendel -/grendel -/klink - Aknalink</p>		1		

Pos

10.11.2017 Piece list - Stückliste - Liste des pièces - Elementi - Stuklijst - Tükítabel
1010x1780 TAK.1.100.TPM0.e DGP+

1/1





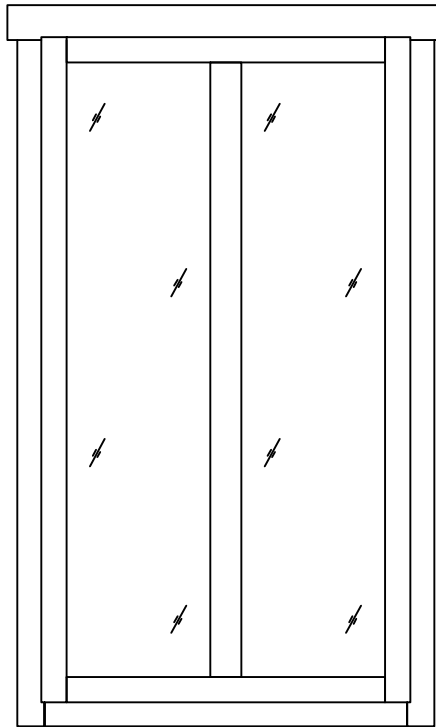

Q

P
(mm)

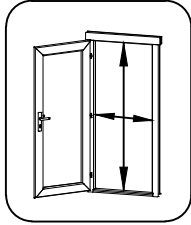
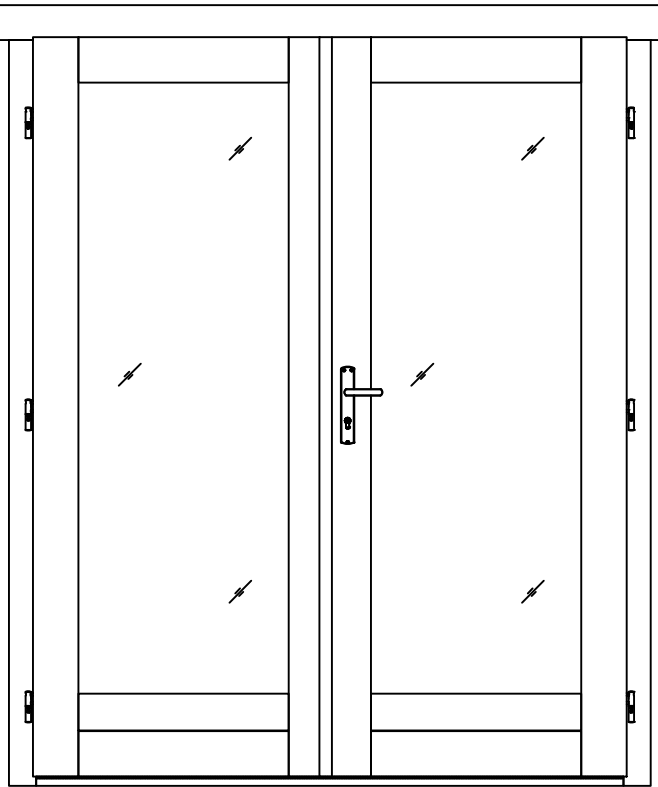
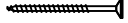
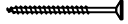
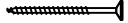
L
(mm)

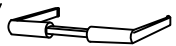
Glass size - Glasgröße - Taille de la vitre - Misura del vetro - Glas afmeting - Klaasi mõõt: 390x1602 mm

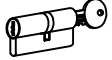

Pos	Piece list - Stückliste - Liste des pièces - Elementi - Stuklijst - Tükitalabel 1588x1957 TUK.1.100.TPVP.MM DGP+	1/1	Q	P (mm)	L (mm)
	Glass size - Glasgröße - Taille de la vitre - Misura del vetro - Glas afmeting - Klaasi mõõt: 561x1593 mm			 1488x1873 mm	
					
HS4	Screw for door fillet - Schraube zur Befestigung türleiste - Vis pour fixation baguette d'arret de porte - Viti per massellino della porta - Schroef voor deurlijst - Kruvi ukse kokkuvaltšiliistule		5	3x30	
HS16	Screw for door jamb - Schraube für Türrahmen - Vis de fixation partie haute avec montants du cadre de porte - Viti x fissaggio montanti porte - Schroef voor deurkozijn - Kruvi ukse lengile		4	5x90	
HS25	Screw for doorstep - Schrauben für swelle - Vis pour fixation barre de seuil - Vite per soglia della porta - Schroef voor deurdorpel - Kruvi lävepakule		3	4.5x65	
MH	Male bolt hinge for door - Türband - Partie male de paumelle de porte - Cerniera anube x porta - Scharnier bout - Reguleeritav polthing isane		6	14x80	
HC	Covers for door hinges - Schutzkappe für Türband - Couverture de paumelle de porte - Copertura delle cerniere della porta - Afdek kap voor deurscharnier - Reguleeritava polthinge kate		12		
TL4	Door handle fittings - Türgriff - Poignée de porte - Maniglie - Deurhendel / klink - Ukse käepide		1		
TL5	Set of door lock covers - Schlossblenden - Set de garnitures de porte - Copertura serrature - Slot sluitplaat set - Ukse lukuplaat		1		
	Cylinder lock - Zylinderschloss - Barillet de porte - Serratura - Cylinder slot - Ukse lukusüdamik		1	30x35	
	Striker for barrel bolt - Hülse für Grendelriegel - Gache au sol du targette - Boccola per fermo della porta - Huls voor vergrendelingsschuif - Vasturaud ukse servariivile		2		