

Berkshire 43
Art. Nr. 4413340
1/9



22.01.2019

Art. Nr. 4413340

Grundplan - Grundplan - Plan de masse - Planimetria - Plattegrond - Põhiplaan

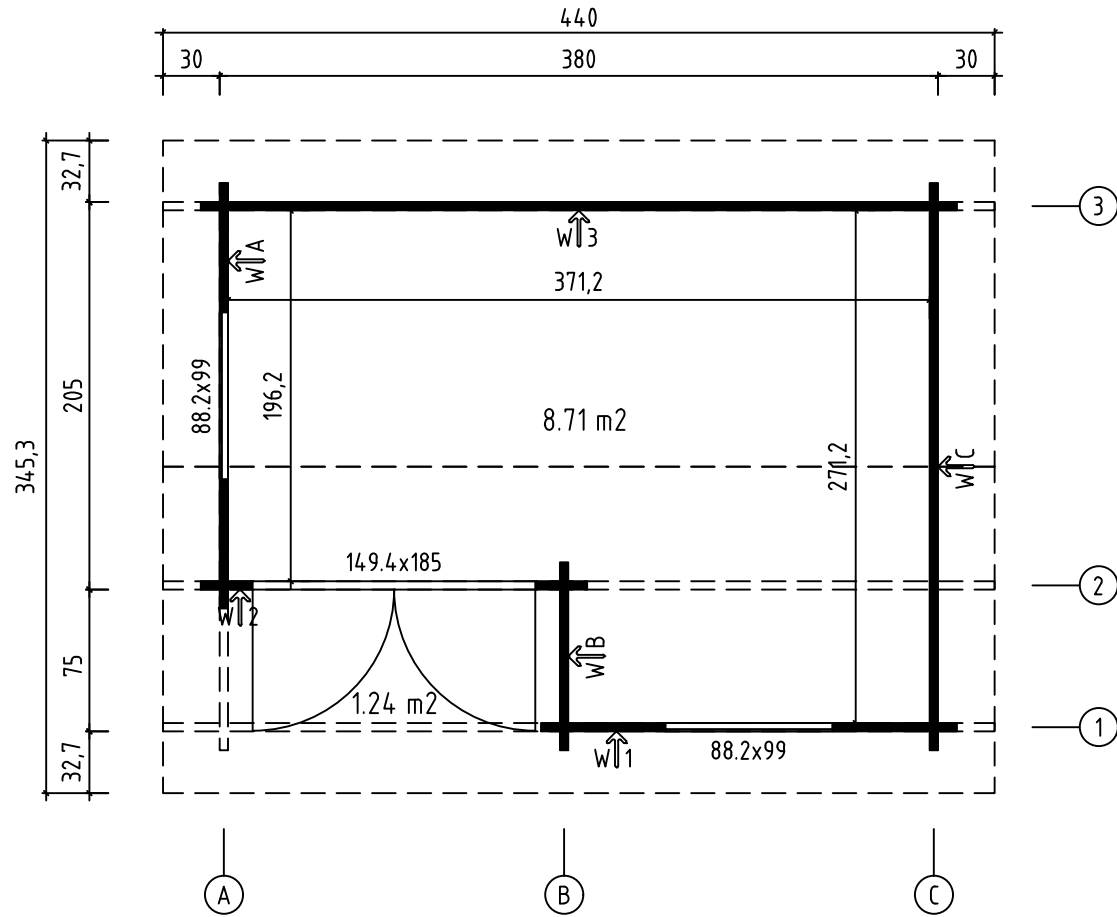

Foundation - Fundament - Fondation - Fondamenta - Fundering - Immutatud alusraam

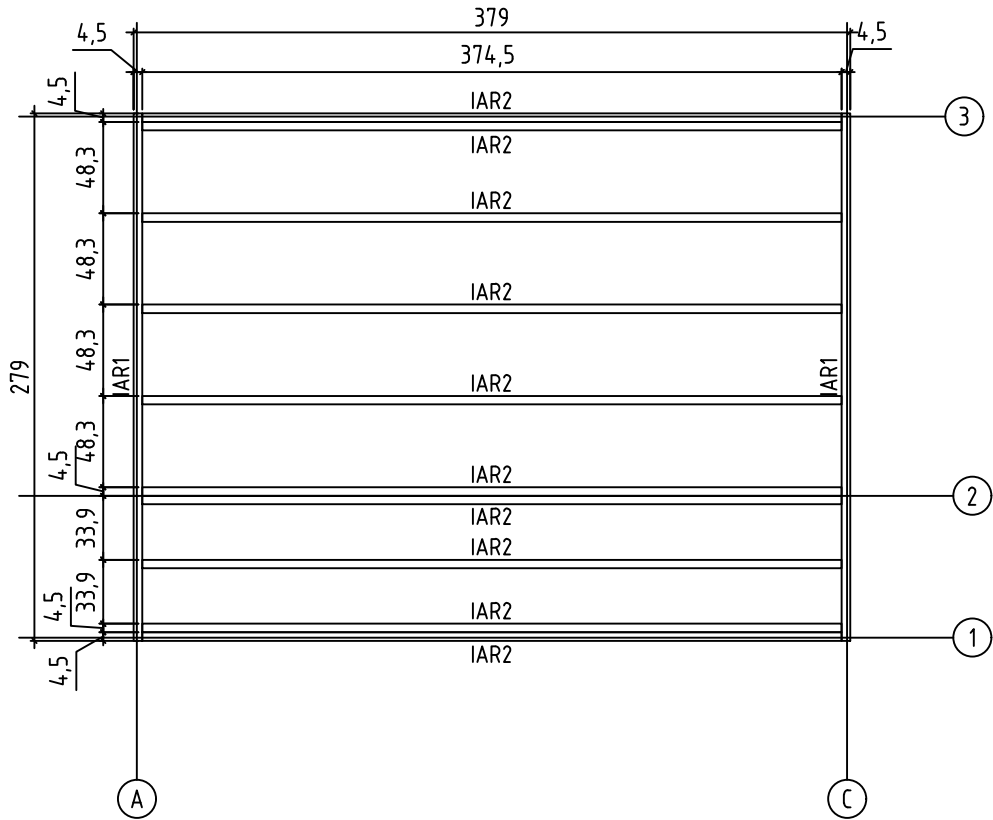

Floor boards - Fussbodenbretter - Plan pose plancher - Pavimento - Vloerhout - Põrandalaudis

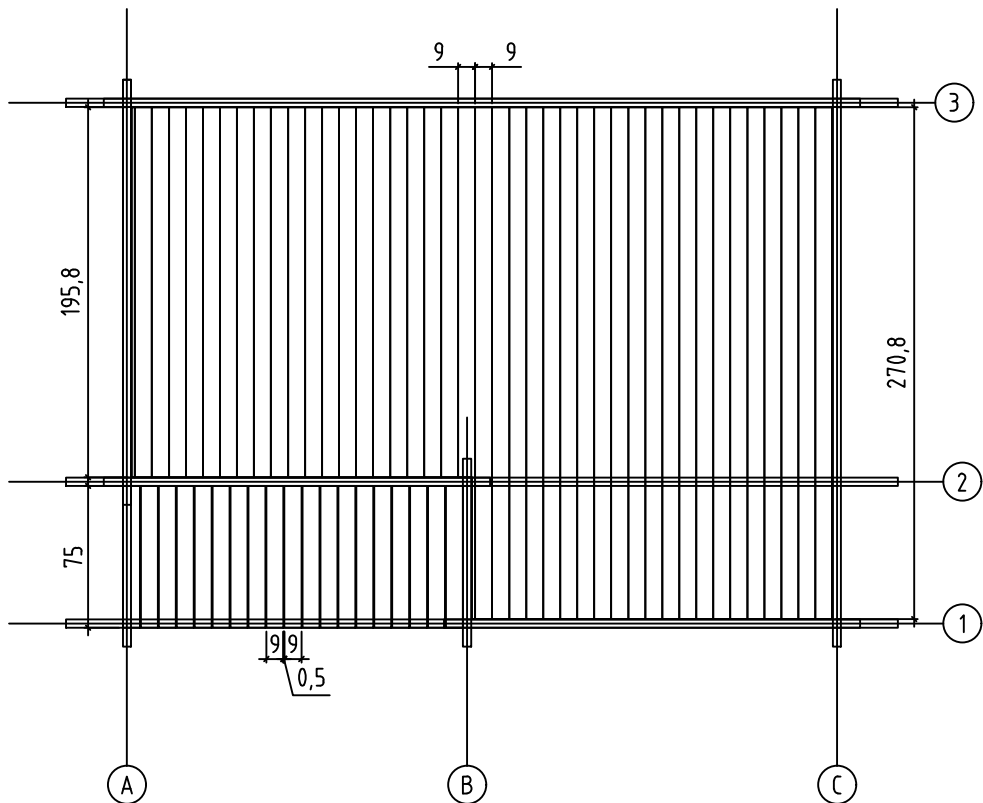

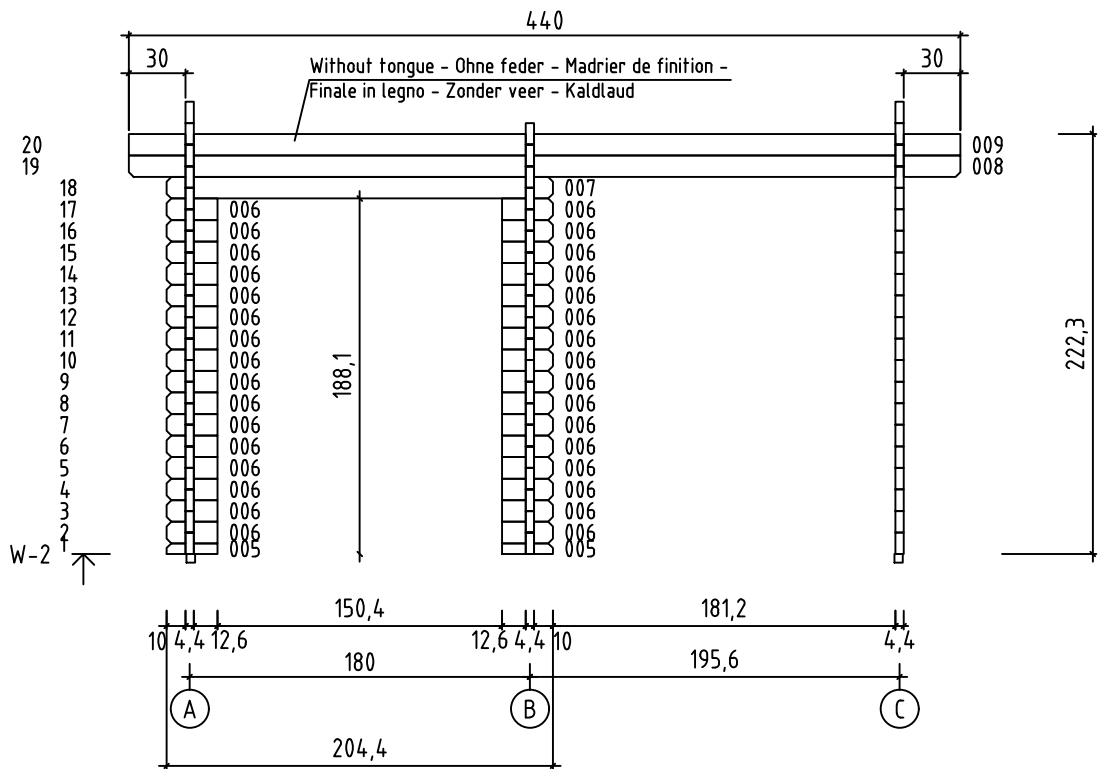
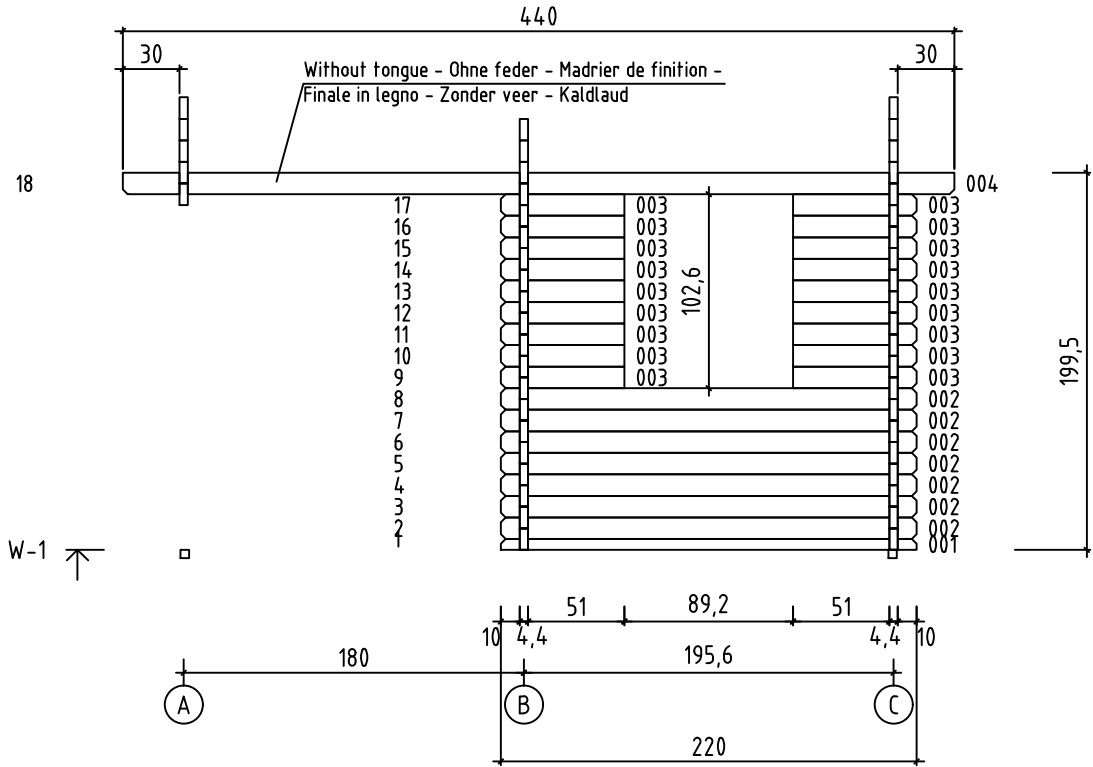

Terrace boards - Terrassenbretter - Plancher de terrasse - Piattaforme terrazzo - Terrasvloer - Terrassilaudis

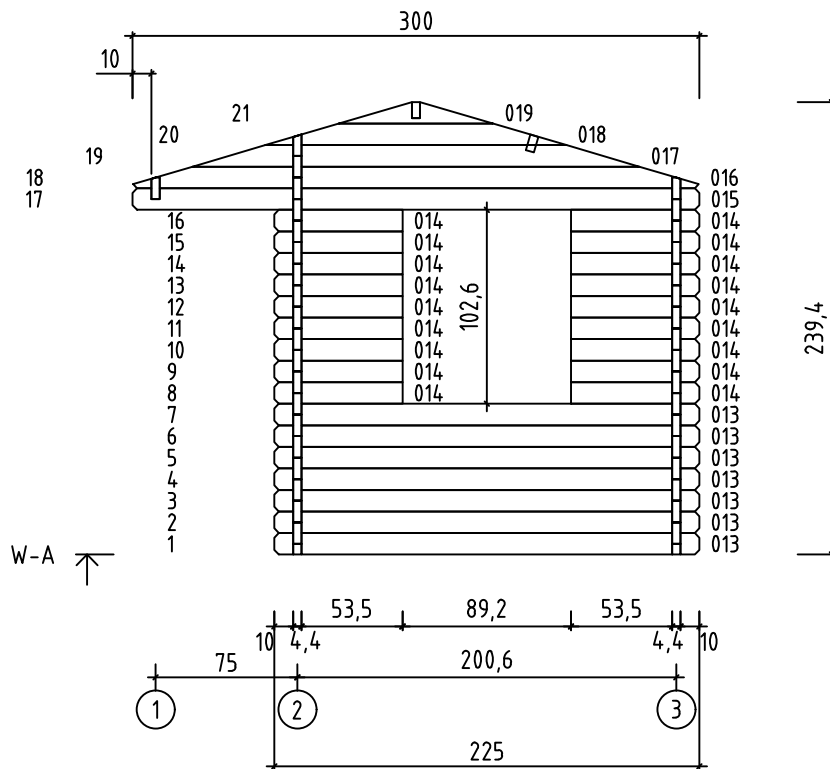
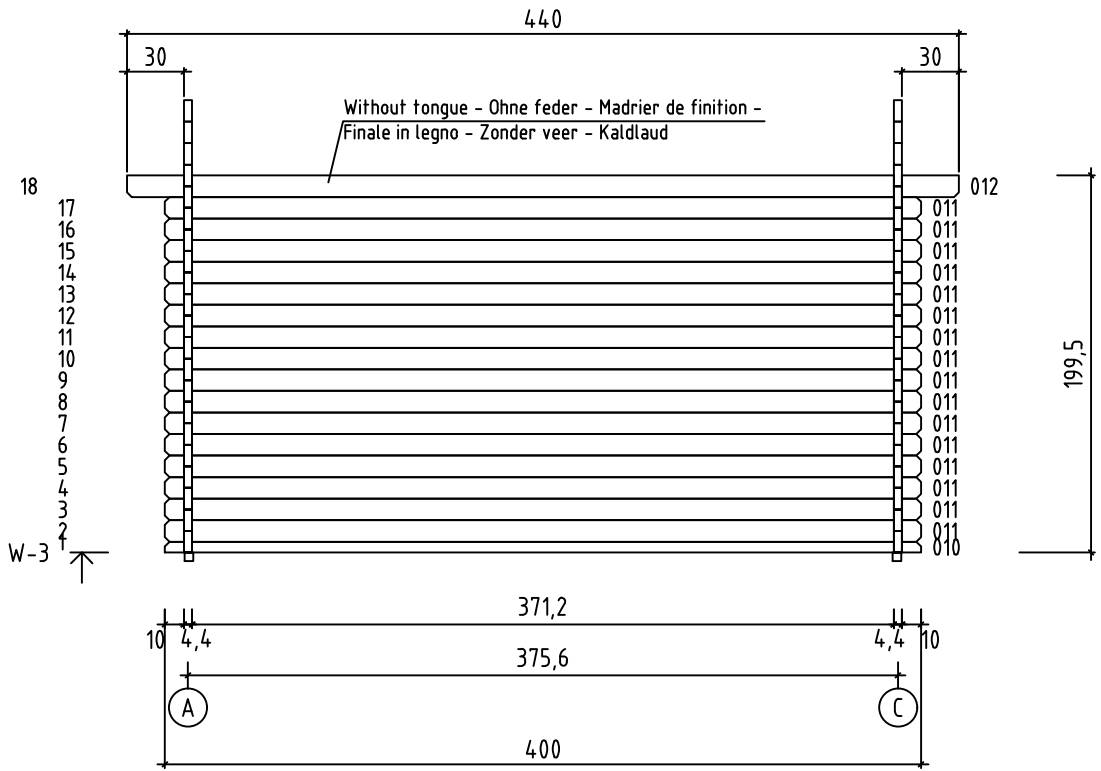

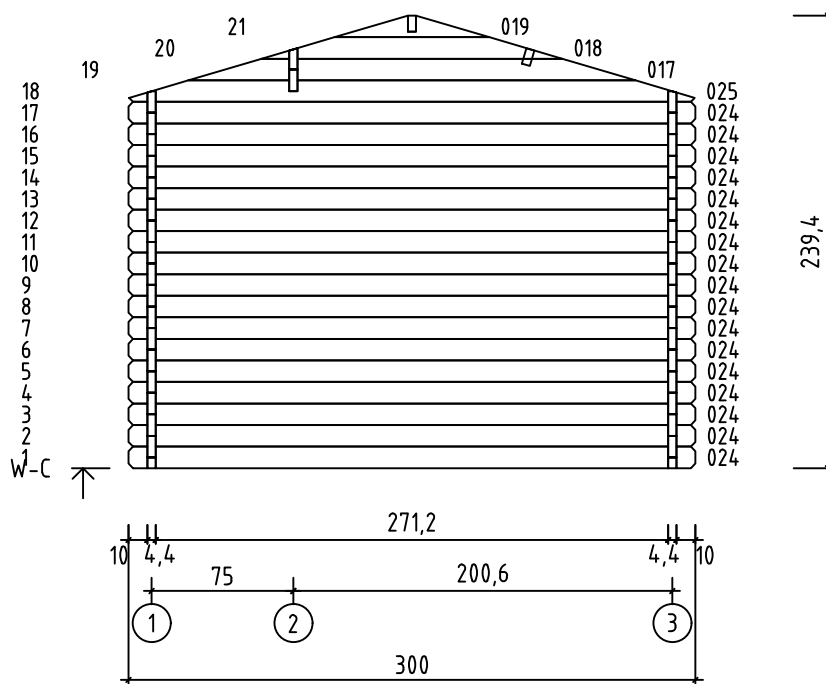
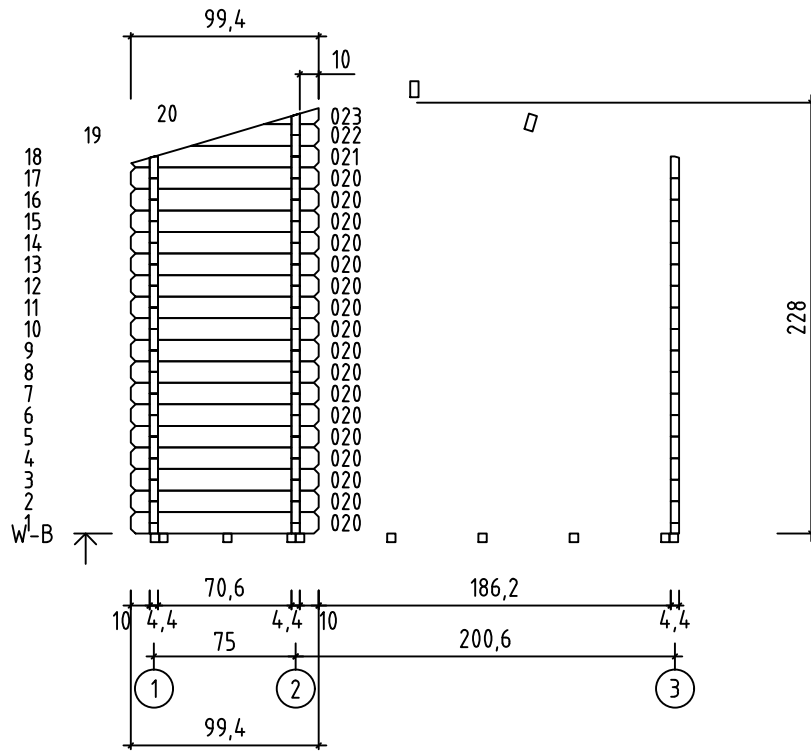

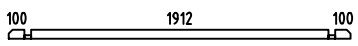
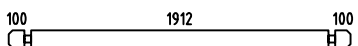
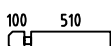
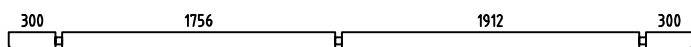
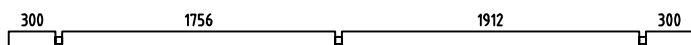

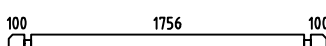
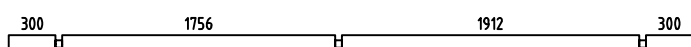
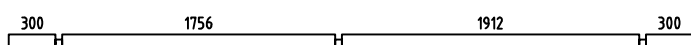
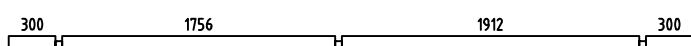
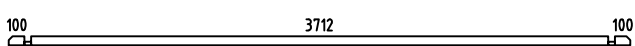
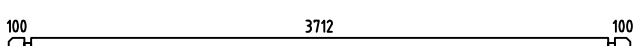
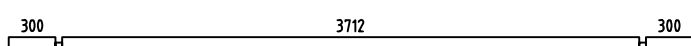
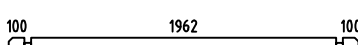
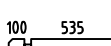
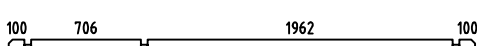
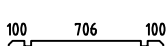
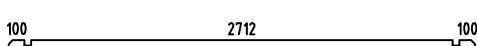
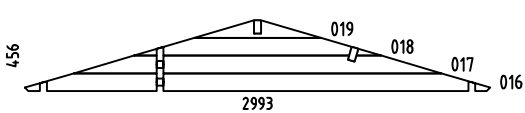
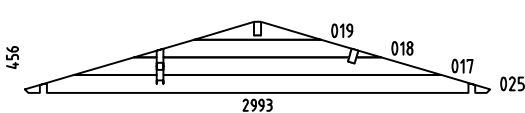



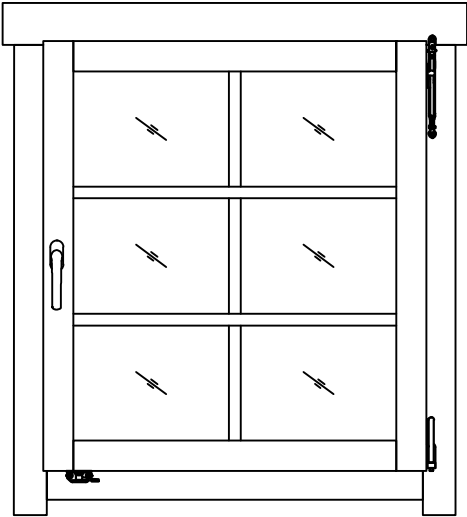
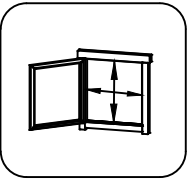
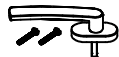
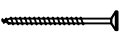

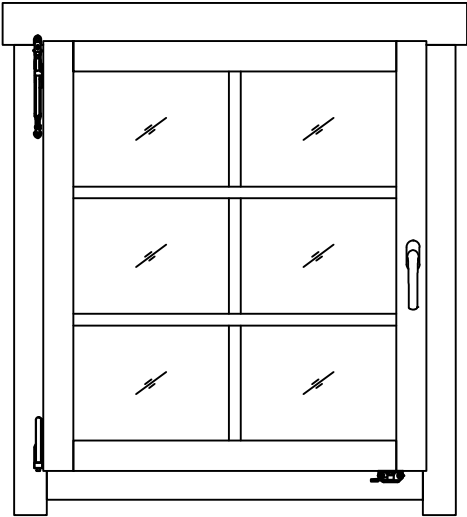
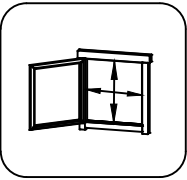
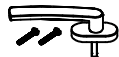
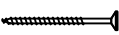

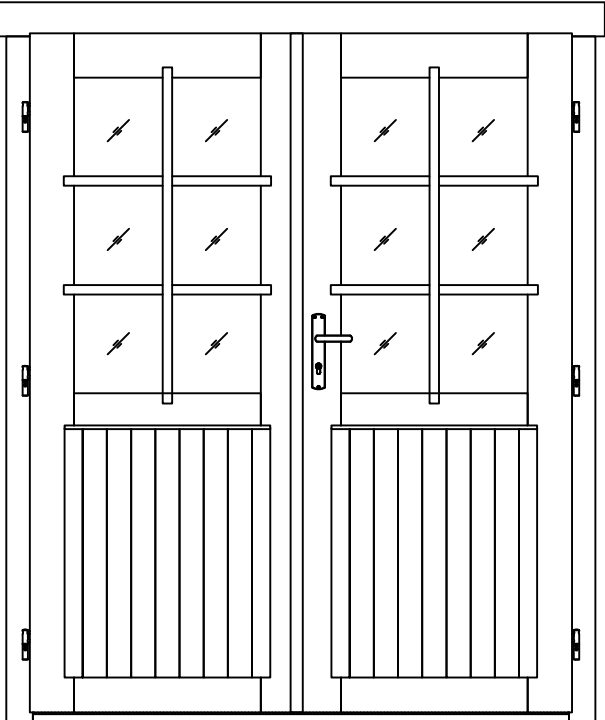

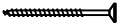
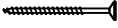
Pos	22.01.2019 Piece list - Stückliste - Liste des pièces - Elementi - Stuklijst - Tükítabel Art. Nr. 4413340	7/9	Q	P (mm)	L (mm)
001			1	44x57	2200
002			7	44x114	2200
003			18	44x114	654
004			1	44x120	4400
004a			1	44x120	4400
005			2	44x57	270
006			32	44x114	270
007			1	44x114	2044
008			1	44x114	4400
009			1	44x113	4400
009a			1	44x113	4400
010			1	44x57	4000
011			16	44x114	4000
012			1	44x120	4400
013			7	44x114	2250
014			18	44x114	679
015			1	44x114	3000
020			17	44x114	994
024			17	44x114	3000
WA-1			1		
WC-1			1		

Pos	22.01.2019	Piece list - Stückliste - Liste des pièces - Elementi - Stuklijst - Tükitalabel Art. Nr. 4413340	8/9	Q	P (mm)	L (mm)
WB-1				1		
IAR2		Foundation - Fundament - Fondation - Fondamenta - Fundering - Immutatud alusraam 		10	45x45	3700
IAR1		Foundation - Fundament - Fondation - Fondamenta - Fundering - Immutatud alusraam 		2	45x45	2790
A-PR1		Roof beam - Dachbalken - Panne de toit - Perlina del tetto - Gordingen / dakbalk - Pärilin 		2	44x140	4400
		Floor boards - Fussbodenbretter - Lame de plancher - Pavimento - Vloerhout - Põrandalaud 		22	90x18	2708
		Floor boards - Fussbodenbretter - Lame de plancher - Pavimento - Vloerhout - Põrandalaud 		20	90x18	1958
		Terrace boards - Terrassenbretter - Plancher de terrasse - Piattaforme terrazzo - Terrasvloer - Terrassilaud 		19	90x19	750
		Roof boards - Dachbretter - Voliges - Perlina per tetto - Dakhout - Katuselaud 		98	90x18	1800
		Floor fillet - Fussbodenleiste - Corniere de finition du plancher - Finitura per pavimento (battisco pa) - Vloerafwerklijs - Põrandaliist 			18x18	12.83
		Roofing felt fillet - Dachpappenleiste - Baguette de fixation du feutre bitumeux - Asse per fissaggio guaina bituminosa - Afdeklijs asfaltpapier - Katusepapiliist 		4	18x58	1850
TB-1		Fascia board - Traufbrett - Bandeau de toit - Finitura lati tetto - Gevellijst - Räästalaud 		2	18x90	4400
DRV-1		Roof edge reinforcement - Dachrandverstärkung - Corniere de renfort de bord de toit - Rinforzo x tetto - Dakrand versterking - Räästatugevdus 		2	28x34	4400
KFS-1		Storm protection - Sturmleiste - Latte anti-tempete - Protezione anti vento - Stormverankering / beveiliging - Tormikinnitusliist 		4	22x45	2050
		Gable moulding - Giebelleiste - Planche de rive - Finitura per frontale e retro del tetto - Gevellijst - Viilulaud 		4	18x120	1850
HS8		Screw for gable segment - Schrauben für deckblatt - Vis pour fixation losange de finition - Viti x frontali tetto - Schroef voor gevelpunt segment - Kruvi rombile 		4	3.5x35	
HS9		Screw for gable moulding - Schrauben für giebelleiste - Vis pour fixation planche de rive - Vite per fissare finiture davanti e dietro del tetto - Schroef voor gevellijst - Kruvi viilulauale 		24	3.5x50	
HS12		Screw for fascia boards - Schrauben für traufbretter - Vis pour fixation bandeau de toit - Viti x striscia del tetto - Schroef voor gevellijst - Kruvi räästalauale 		20	4x40	
HS12		Screw for roof edge reinforcement - Schrauben für dachrandverstärkung - Vis pour fixation corniere renfort de bord de toit - Viti x rinforzo bordo tetto - Schroef voor dakrand versterking - Kruvi räästatugevdusele 		20	4x40	
HS18		Screw for gable - Schrauben für giebel - Vis pour fixation des pignons - Viti per timpano - Schroef voor gevelpunt - Kruvi kelba kinnitamiseks 		16	5x120	
HS18		Screw for roof beams - Schrauben für dachbalken - Vis pour fixation pannes de toit - Viti per perline del tetto - Schroef voor gordingen / dakbalken - Kruvi pärlinitele 		4	5x120	
HS18		Screw for gable - Schrauben für giebel - Vis pour fixation des pignons - Viti per timpano - Schroef voor gevelpunt - Kruvi viilude kinnitamiseks 		8	5x120	
HS16		Screw for 1. wall beam - Schraube für 1. bohlenreihe - Vis de fixations 1ere rangée de madriers avec poutrelles de fondations - Vite fissaggio alle fondamenta - Schroef voor 1 wandbalk - Kruvi poollauale 		9	5x90	
HS16		Screw for foundation - Schrauben zur befestigung fundament - Vis de fixations des poutrelles de fondations - Viti x fondamenta - Schroef voor fundering - Kruvi alusraamile 		26	5x90	

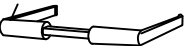
Pos	27.11.2017 Piece list - Stückliste - Liste des pièces - Elementi - Stuklijst - Tükitalbel 882x990 AK.1.106.TPSP.a DGP+	1/1	Q	P (mm)	L (mm)
<p data-bbox="263 145 1284 174">Glass size - Glasgröße - Taille de la vitre - Misura del vetro - Glas afmeting - Klaasi mõõt: 712x812 mm</p> <div data-bbox="619 280 1088 795" style="text-align: center;">  </div> <div data-bbox="1337 168 1524 347" style="text-align: right;">  <p data-bbox="1369 369 1492 398">782x902 mm</p> </div>					
FS2	Window handle fittings - Fenstergriff - Poignee de fenetre - Maniglia c/ferramenta - Raamhendel -/grendel -/klink - Aknalink		1		
HS1	Screw for georgian bars - Schraube für sprossen - Vis pour croisillons - Viti per unire la griglia georgiana della finestra - Schroeven voor raamverdeling - Kruvi akna petfeliistule		6	2.5x20	

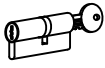
Pos	27.11.2017 Piece list - Stückliste - Liste des pièces - Elementi - Stuklijst - Tükítabel 882x990 AK.1.106.TPSV.a DGP+	1/1	Q	P (mm)	L (mm)
<p data-bbox="263 145 1284 174">Glass size - Glasgröße - Taille de la vitre - Misura del vetro - Glas afmeting - Klaasi mõõt: 712x812 mm</p> <div data-bbox="619 280 1088 795" style="text-align: center;">  </div> <div data-bbox="1337 168 1524 347" style="text-align: right;">  <p data-bbox="1369 369 1492 398">782x902 mm</p> </div>					
FS2	Window handle fittings - Fenstergriff - Poignée de fenetre - Maniglia c/ferramenta - Raamhendel -/grendel -/klink - Aknalink		1		
HS1	Screw for georgian bars - Schraube für sprossen - Vis pour croisillons - Viti per unire la griglia georgiana della finestra - Schroeven voor raamverdeling - Kruvi akna petfeliistule		6	2.5x20	

Pos	Piece list - Stückliste - Liste des pièces - Elementi - Stuklijst - Tükitalabel 1494x1850 TUK.2.056.TPVP.MMWc DGP+	1/1	Q	P (mm)	L (mm)
<p>Glass size - Glasgröße - Taille de la vitre - Misura del vetro - Glas afmeting - Klaasi mõõt: 514x855 mm</p> <div style="display: flex; justify-content: space-around; align-items: center;">  <div style="text-align: center;">  <p>1394x1766 mm</p> </div> </div>					
HS1	Screw for georgian bars - Schraube für sprossen - Vis pour croisillons - Viti per unire la griglia georgiana della finestra - Schroeven voor raamverdeling - Kruvi ukse petteliistule		12	2.5x20	
HS4	Screw for door fillet - Schraube zur befestigung türleiste - Vis pour fixation baguette d'arret de porte - Viti per massellino della porta - Schroef voor deurlijst - Kruvi ukse kokkuvaltsiliistule		5	3x30	
HS16	Screw for door jamb - Schraube für türrahmen - Vis de fixation partie haute avec montants du cadre de porte - Viti x fissaggio montanti porte - Schroef voor deurkozijn - Kruvi ukse lengile		4	5x90	
HS25	Screw for doorstep - Schrauben für swelle - Vis pour fixation barre de seuil - Vite per soglia della porta - Schroef voor deurdorpel - Kruvi lävepakule		3	4.5x65	
MH	Male bolt hinge for door - Türband - Partie male de paumelle de porte - Cerniera anube x porta - Scharnier bout - Reguleeritav polthing isane		6	14x80	
HC	Covers for door hinges - Schutzkappe für türband - Couverture de paumelle de porte - Copertura delle cerniere della porta - Afdek kap voor deurscharnier - Reguleeritava polthinge kate		12		
TL4	Door handle fittings - Türgriff - Poignee de porte - Maniglie - Deurhendel klink - Ukse käepide		1		
TL5	Set of door lock covers - Schlossblenden - Set de garnitures de porte - Copertura serrature - Slot sluitplaat set - Ukse lukuplaat		1		
	Cylinder lock - Zylinderschloss - Barillet de porte - Serratura - Cylinder slot - Ukse lukusüdamik		1	30x35	
	Striker for barrel bolt - Hülse für grendelriegel - Gache au sol du targette - Boccola per fermo della porta - Huls voor vergrendelingsschuif - Vasturaud ukse servariivile		2		