

Dorset 73
Art. Nr.709702

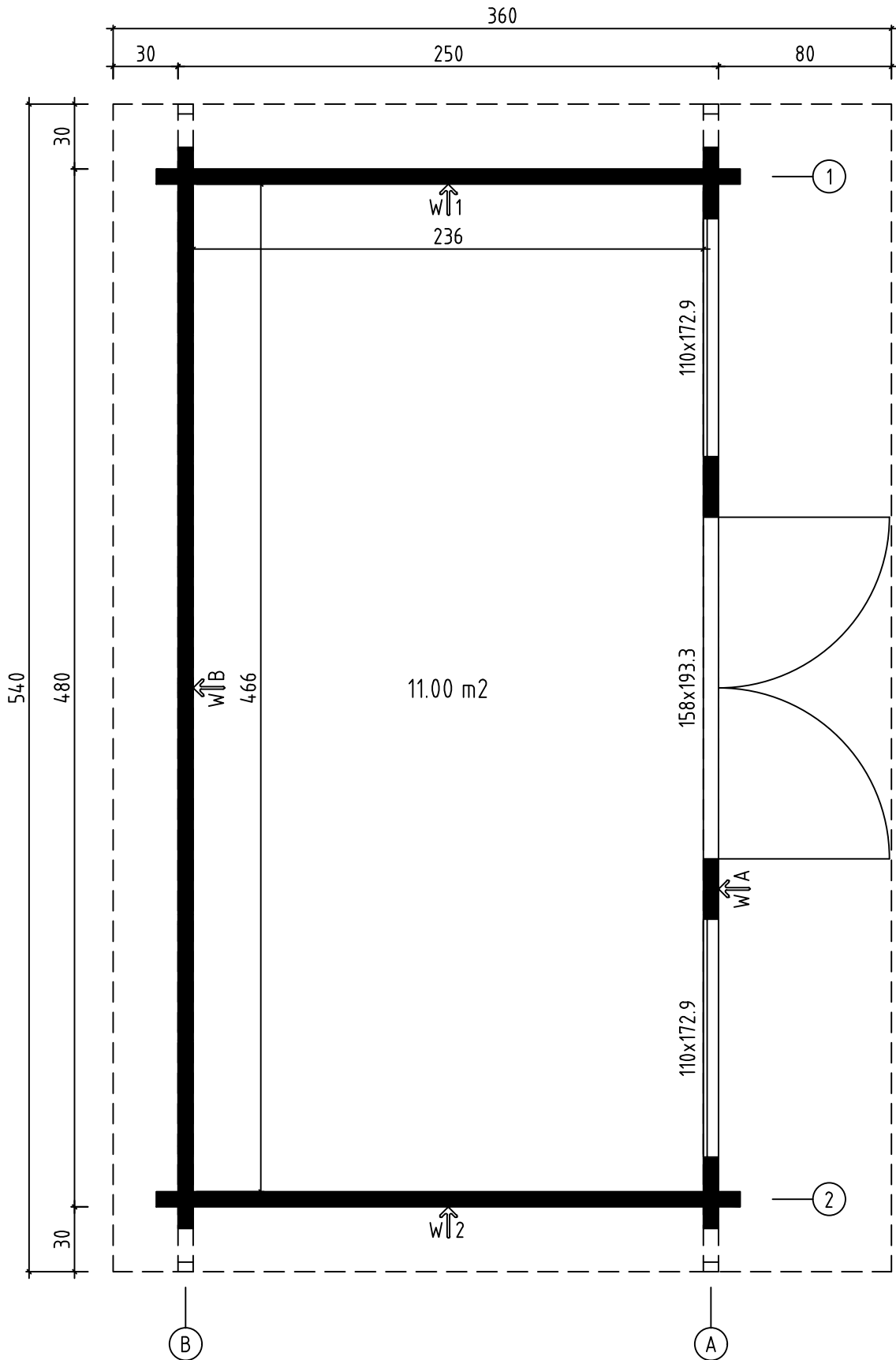

Groundplan - Grundplan - Plan de masse -
Planimetria - Plattegrond - Põhiplaan



Foundation - Fundament - Fondation -
Fondamenta - Fundering - Immutatud alusraam

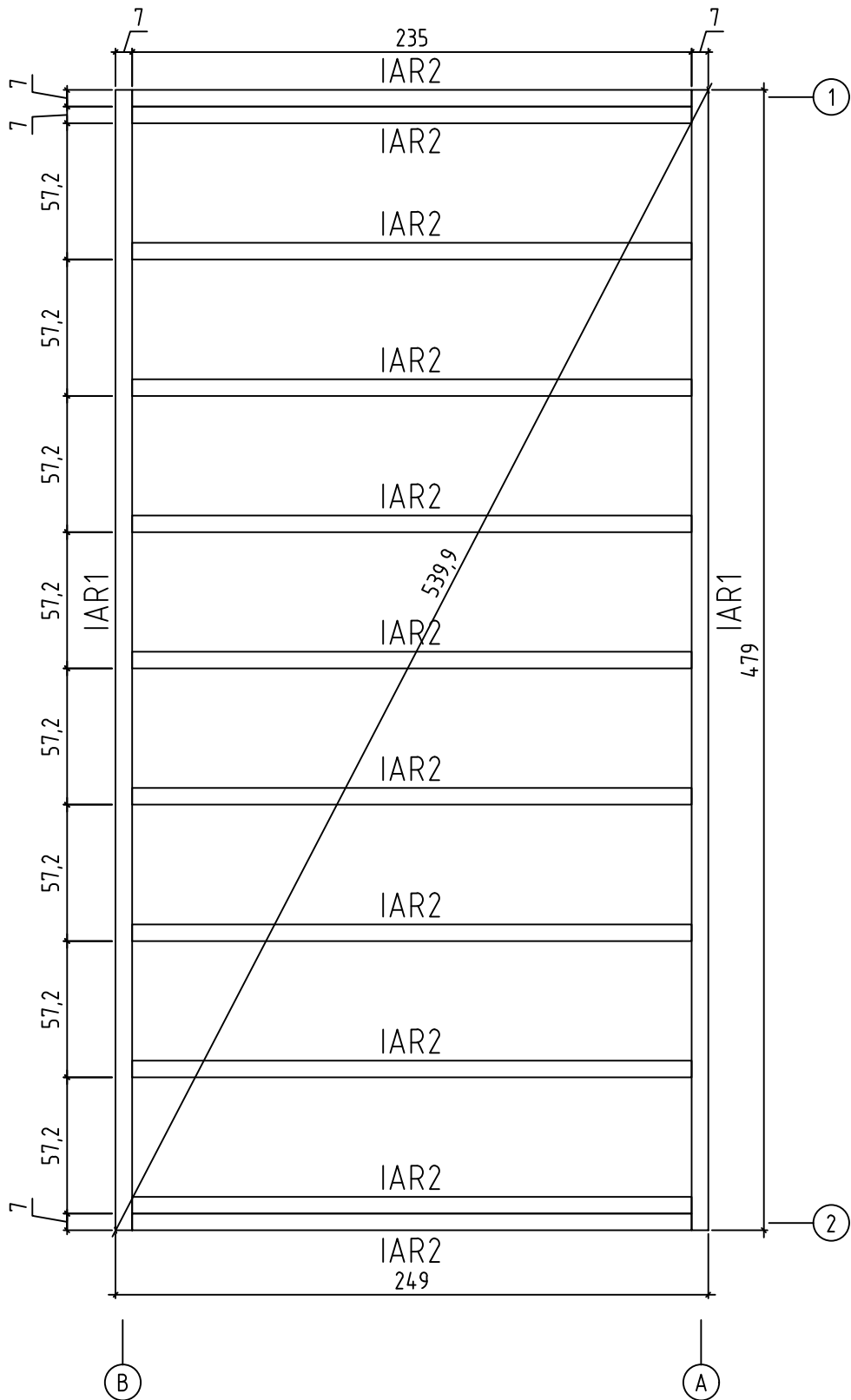

Rafters plan - Dachsparren - Plan de chevron - Piano di travi -
Dak spar constructie plattegrond - Sarikaplaan

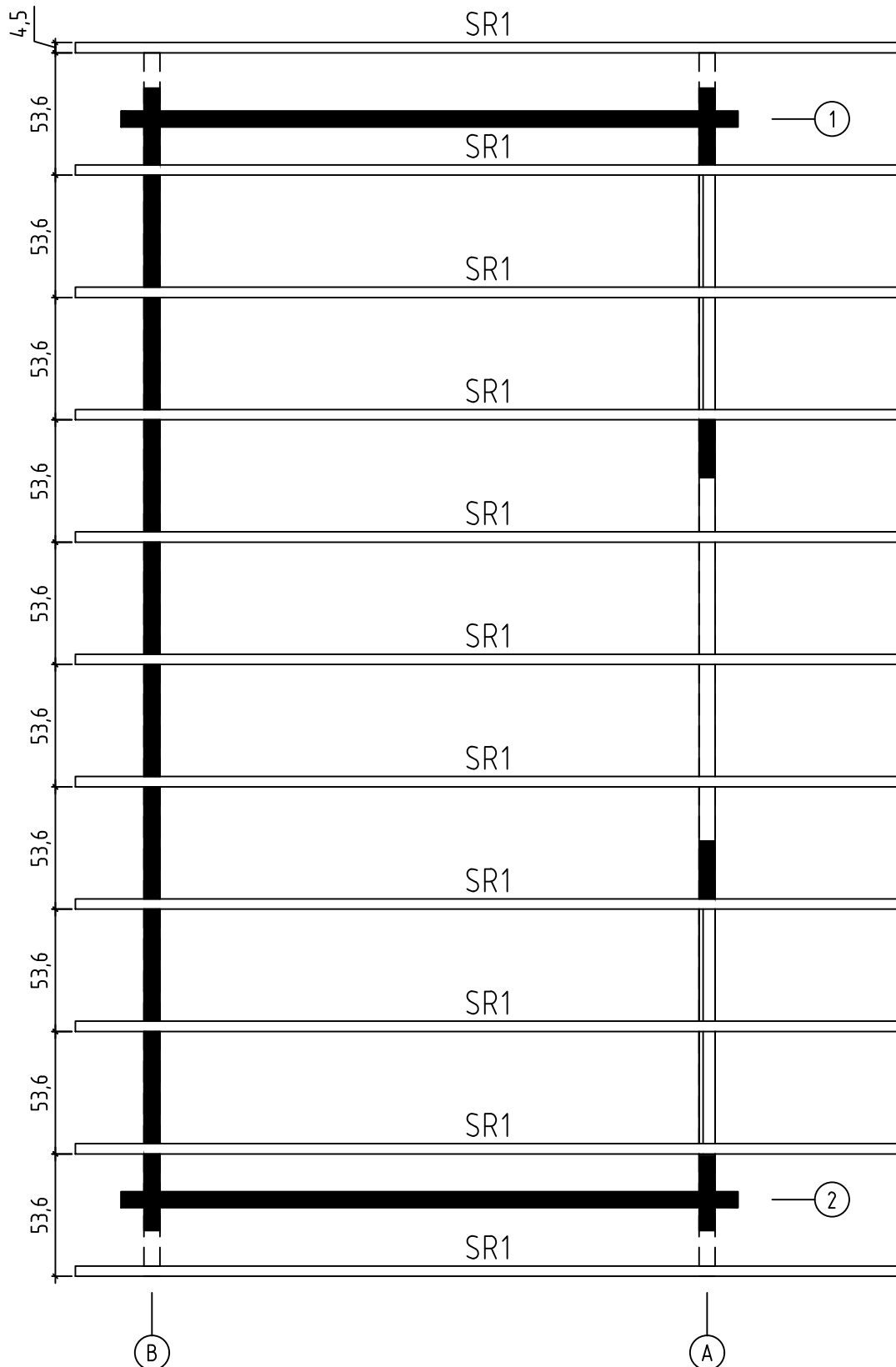

Floor boards - Fussbodenbretter - Plan pose plancher -
Pavimento - Vloerhout - Põrandalaudis

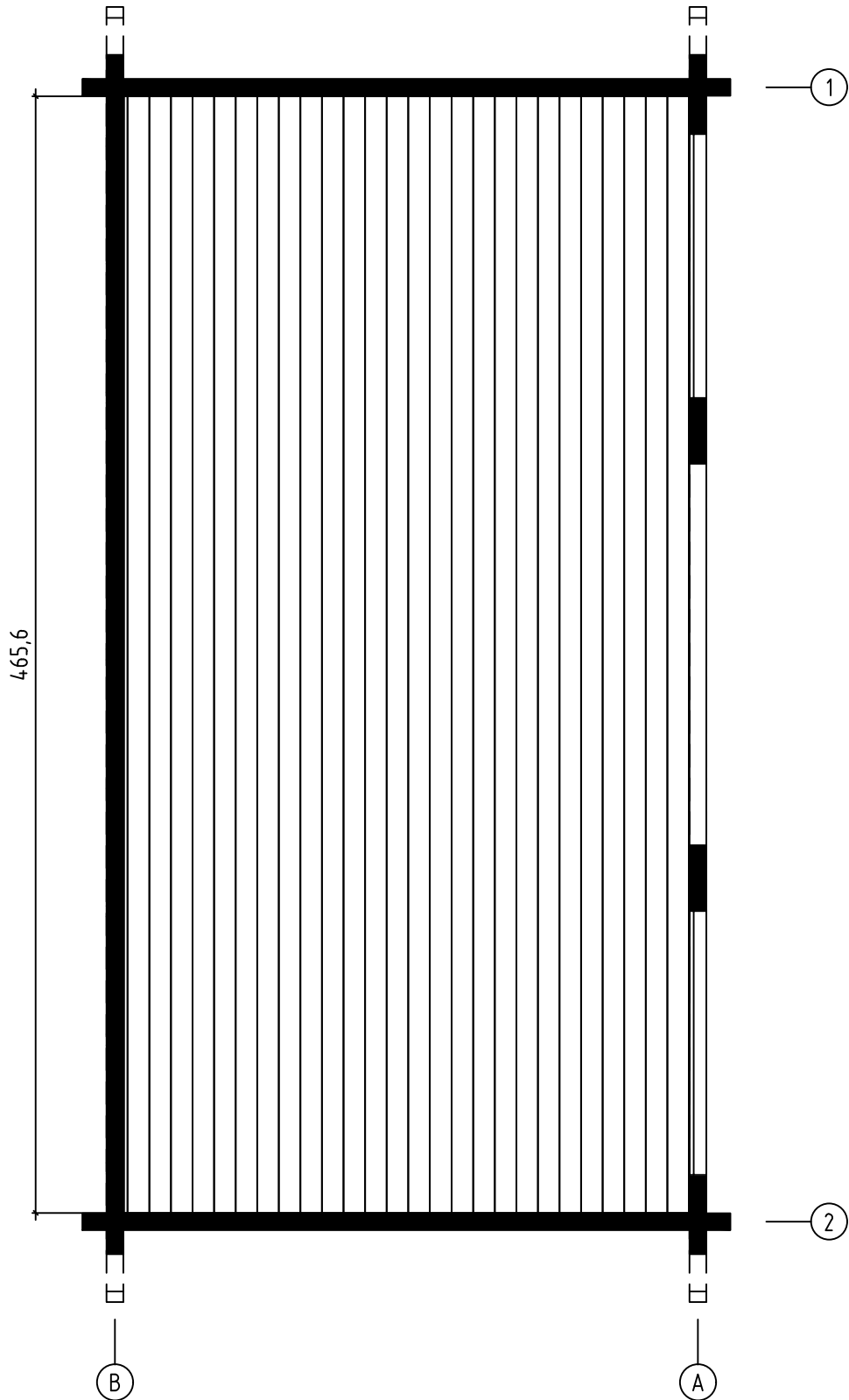

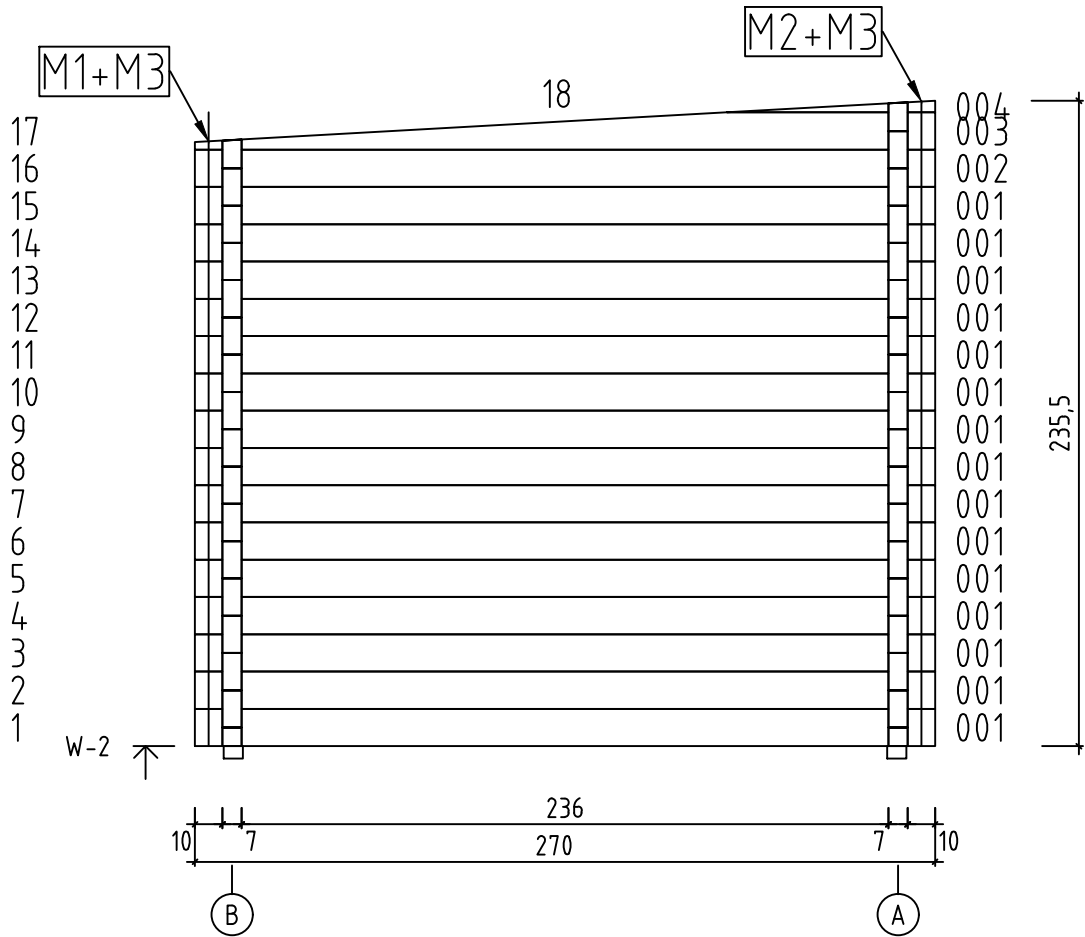
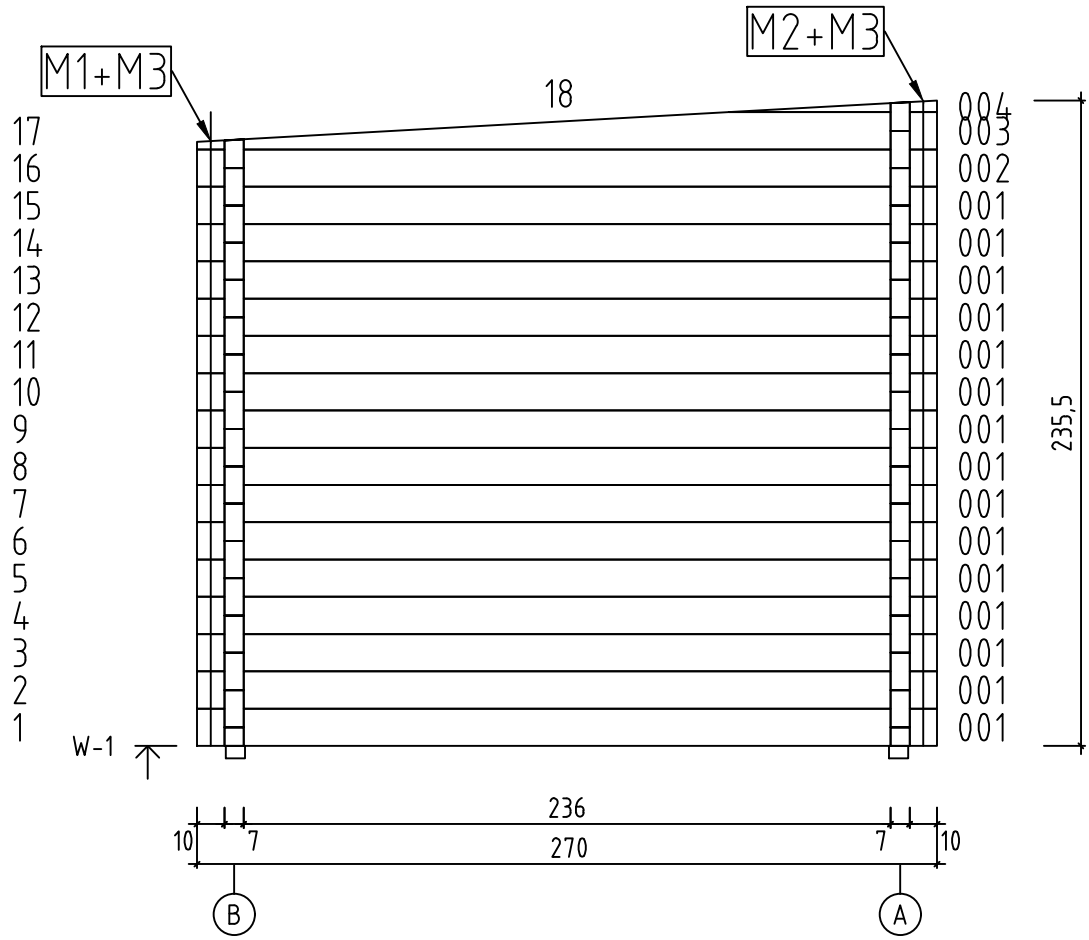



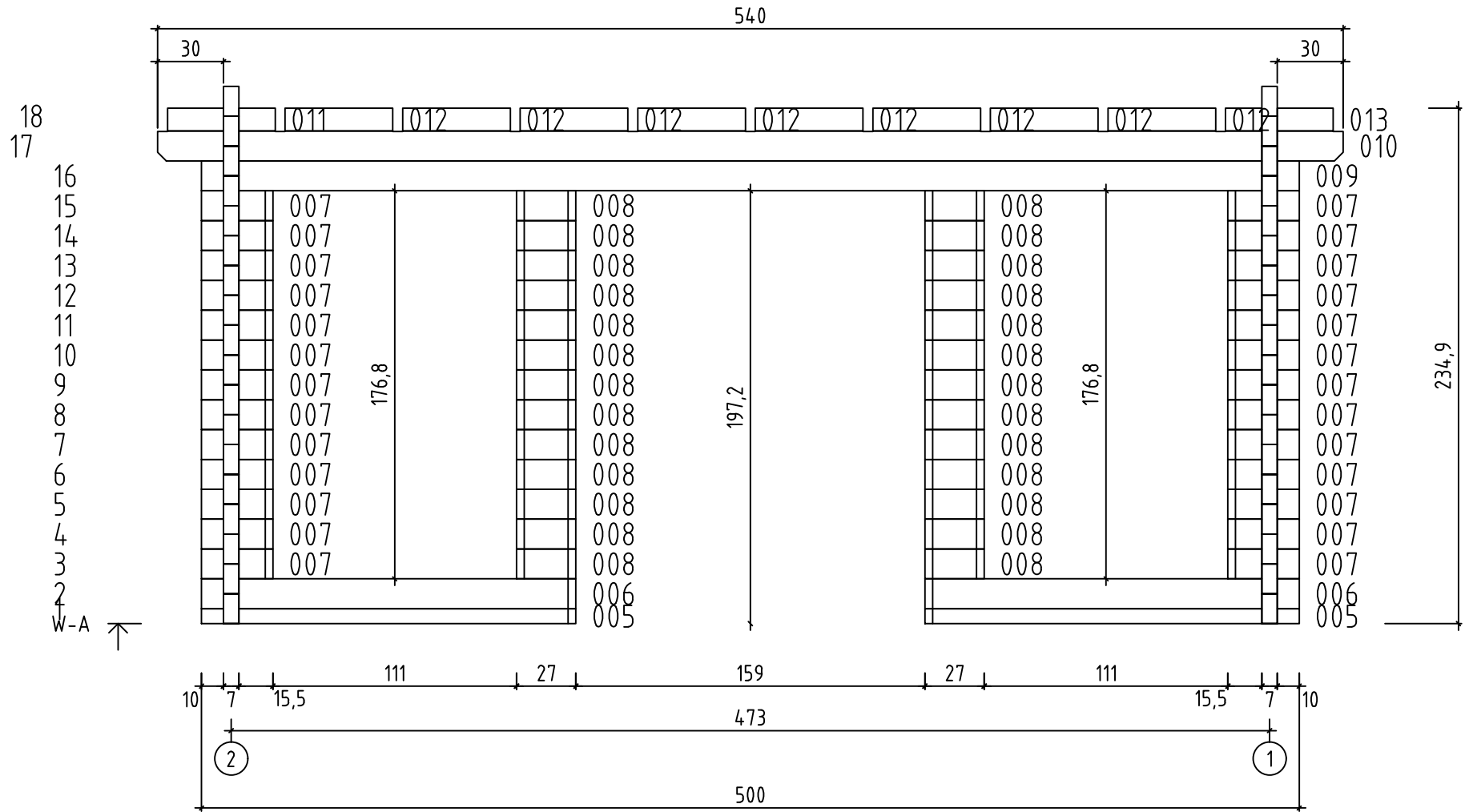



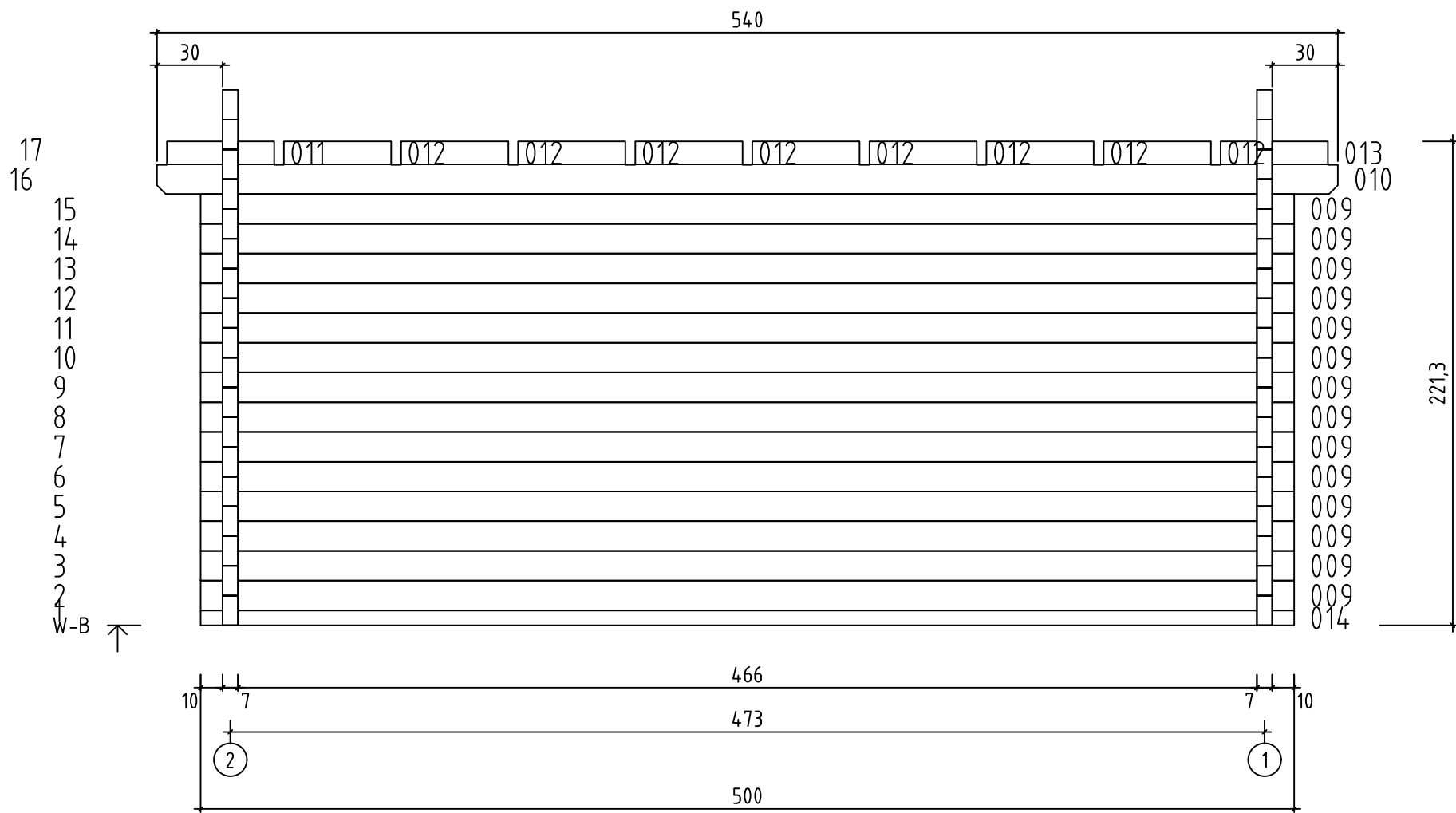

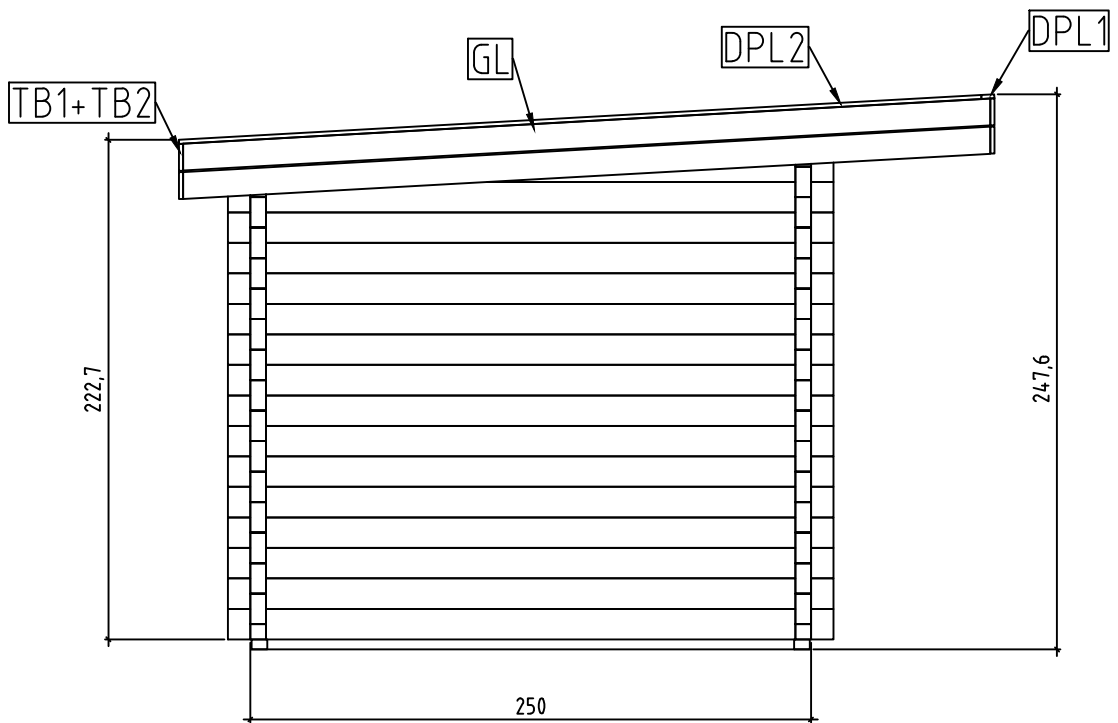
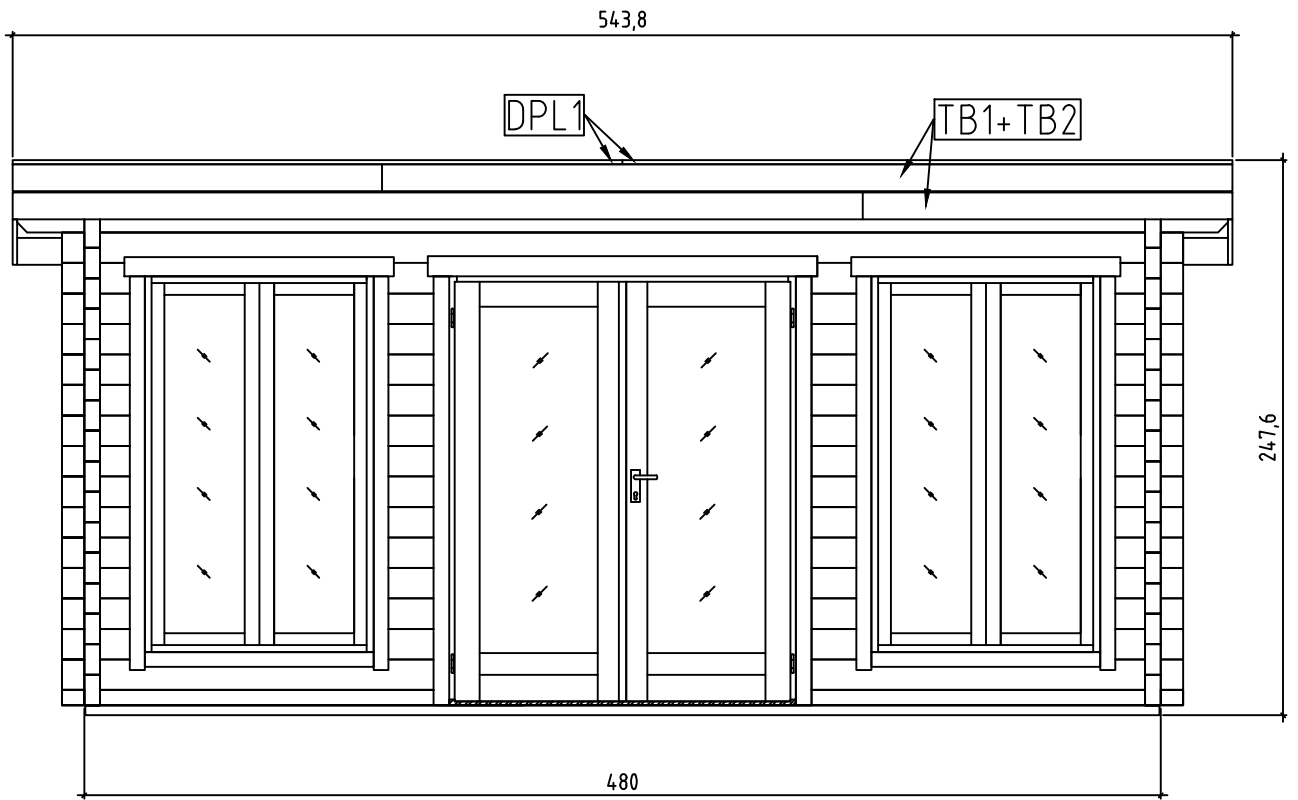

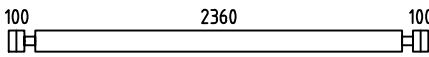
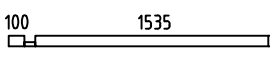
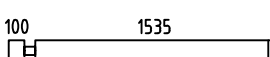
Dorset 73, Art.No.709702

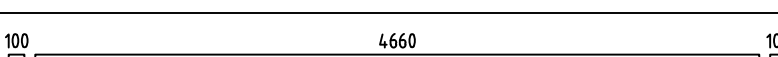
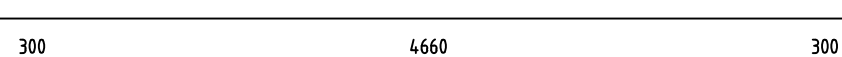
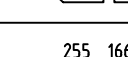
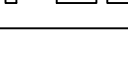
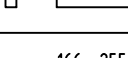
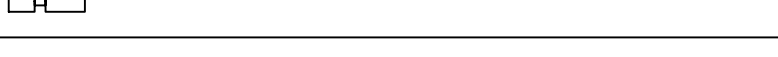
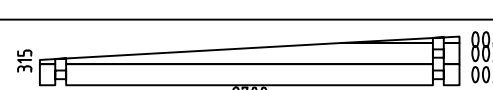
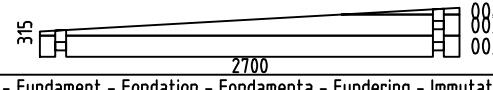

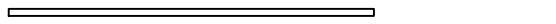
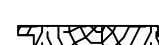
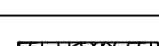



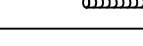

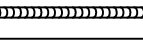

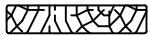

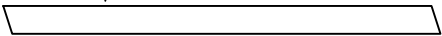
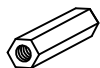



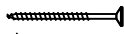
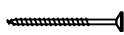

Dorset 73, Art.No.709702



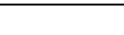

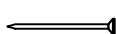
Pos	Dorset 73, Art.No.709702 Piece list - Stückliste - Liste des pièces - Elementi - Stuklijst - Tükitalabel	Q	P (mm)	L (mm)
001		30	70x136	2700
005		2	70x68	1705
006		2	70x136	1705
007		26	70x136	325
008		26	70x136	270
009		15	70x136	5000
010		2	70x136	5400
011		2	70x105	491
012		16	70x105	491
013		2	70x105	491
014		1	70x68	5000
W1-1		1		
W2-1		1		
IAR1	Foundation - Fundament - Fondation - Fondamenta - Fundering - Immutatud alusraam 	2	70x45	4790
IAR2	Foundation - Fundament - Fondation - Fondamenta - Fundering - Immutatud alusraam 	11	70x45	2350
SR1	SARIKAD 	11	45x140	3613
FB	Floor boards - Fussbodenbretter - Lame de plancher - Pavimento - Vloerhout - Põrandalaud 	27	90x18	4656
RB	Roof boards - Dachbretter - Voliges - Perlina per tetto - Dakhout - Katuselaud 	40	90x18	5400
FL	Floor fillet - Fussbodenleiste - Corniere de finition du plancher - Finitura per pavimento (battisco pa) - Vloerafwerkljst - Põrandaliist 		18x18	15
DPL1	Roofing felt fillet - Dachpappenleiste - Baguette de fixation du feutre bitumeux - Asse per fissaggio guaina bituminosa - Afdekljst asfaltpapier - Katusepapiliist 	2	18x58	2719
DPL2	Roofing felt fillet - Dachpappenleiste - Baguette de fixation du feutre bitumeux - Asse per fissaggio guaina bituminosa - Afdekljst asfaltpapier - Katusepapiliist 	2	18x58	3584
M1	Treaded rod m12 - Gewindestange m12 - Tige filetée m12 - Barra filettata passo m12 - Draadstang 12m - Keermelatt 	2		235
M2	Treaded rod m12 - Gewindestange m12 - Tige filetée m12 - Barra filettata passo m12 - Draadstang 12m - Keermelatt 	2		380
M3	Treaded rod m12 - Gewindestange m12 - Tige filetée m12 - Barra filettata passo m12 - Draadstang 12m - Keermelatt 	4		2000
TB1	Fascia board - Traufbrett - Bandeau de toit - Finitura lati tetto - Gevelljst - Räästalaud 	4	18x120	1648

Pos	Dorset 73, Art.No.709702 Piece list - Stückliste - Liste des pièces - Elementi - Stuklijst - Tükitalabel	Q	P (mm)	L (mm)
TB2	Fascia board - Traufbrett - Bandeau de toit - Finitura lati tetto - Gevellijst - Räästalaud 	4	18x120	3790
TBE6-1	Fixing fillet - Fixierungsleiste - Profil de fixation - Massello di fissaggio - Bevestiging lijstwerk - Tenderlijst 	4	28x34	1729
TBE6-2	Fixing fillet - Fixierungsleiste - Profil de fixation - Massello di fissaggio - Bevestiging lijstwerk - Tenderlijst 	2	28x34	1933
GL	Gable moulding - Giebelleiste - Planche de rive - Finitura per frontale e retro del tetto - Gevellijst - Viilulaud 	4	18x120	3612
KL4	Lengthening bolt for threaded rod - Verlängerungsmutter für gewindestange - Manchon de raccordement de tige filetée - Bullone per barra filettata passo - Extensie moer voor draadstang - Jätkumutter keermelatile 	4		
KL1	Drive nut threaded rod - Ein Schlagmutter für gewindestange - Écrou a frapper pour tige filetée - Dado guida per barra filettata - Aandrijfmoer / aanslagmoer voor draadstang - Löökmutter keermelatile 	4		
KL2	Nut for threaded rod - Mutter für gewindestange - Écrou pour tige filetée - Dado per barra filettata - Moer voor draadstang - Mutter keermelatile 	4		
KL3	Plain washer threaded rod - Unterlegscheibe für gewindestange - Rondelle plate pour tige filetée - Rondella per barra filettata - Sluitring voor draadeind - Seib keermelatile 	4		
HS32	Screw for fascia boards - Schrauben für traufbretter - Vis pour fixation bandeau de toit - Viti x striscia del tetto - Schroef voor gevellijst - Kruvi räästalauale 	70	3.5x50	
HS84	Screw for fixing fillet - Schrauben für fixierungsleiste - Vis pour profil vertical de fixation pour ouvertures - Viti per massello di fissaggio - Schroeven voor bevestiging van deur en raam lijsten - Kruvi tenderlijstudele 	26	3.5x50	
HS16	Screw for gable moulding - Schrauben für giebelleiste - Vis pour fixation planche de rive - Vite per fissare finiture davanti e dietro del tetto - Schroef voor gevellijst - Kruvi viilulauale 	32	3.5x50	
NFD	Screw for roofing felt fillet - Schrauben für dachpappenleiste - Vis pour fixation baguette de fixation feutre bitumeux - Vite per massellino del feltro del tetto - Schroef voor asfaltpaier afdeklijst - Kruvi katusepapiliistule 	28	4x40	
HS40	Screw for 1. wall beam - Schraube für 1. bohlenreihe - Vis de fixations 1ere rangée de madriers avec poutrelles de fondations - Vite fissaggio alle fondamenta - Schroef voor 1 wandbalk - Kruvi poollauuale 	8	5x120	
HS39	Screw for foundation - Schrauben zur befestigung fundament - Vis de fixations des poutrelles de fondations - Viti x fondamenta - Schroef voor fundering - Kruvi alusraamile 	30	5x120	
HS42	Screw for gable - Schrauben für giebel - Vis pour fixation des pignons - Viti per timpano - Schroef voor gevelpunt - Kruvi viilude kinnitamiseks 	4	5x120	
HS48	Screw for pos.011-013 - Schrauben für pos.011-013 - Vis pour pos.011-013 - Viti per fissare elemento vedi figura in pos. n.011-013 - Schroef voor pos.011-013 - Kruvi pos.011-013 	40	6x180	
HS44	Screw for rafter - Schrauben für dachsparren - Vis pour chevron - Vite per trave - Schroef voor dakspar - Kruvi sarikatele 	22	6x180	
MS	Screw for doorstep - Schrauben für swelle - Vis pour fixation barre de seuil - Vite per soglia della porta - Schroef voor deurdorpel - Kruvi lävepakule 	3	4.5x65	
SH70	Hammer block - Schlagholz - Calle de frappe - Blocco di legno da usare come cuscinetto quando si usa il martello - Slagklos - Löögiklots 	1		
NFF	Zn nail for floor fillet - Zn nagel für fussbodenleiste - Pointe pour corniere de finition du plancher - Chiodi x fissaggio pavimento - Spijker(nagel) voor vloer afdeklijst - Nael põrandaliistule 	28		
NF2	Zn nail for roof - Zn nagel für dachbretter - Pointe pour fixation voliges de toit - Chiodi x perline tetto - Spijker(nagel) voor dakhout - Nael katuselauuale 	533	2.1x50	
NH1	Zn nail for floor - Zn nagel für fussbodenbretter - Clous pour plancher - Chiodi x perline pavimento - Spijker(nagel) voor vloer - Nael põrandalauale 	252	2.1x50	
ORZ	Montage set for doors and windows - Montage-set für türen und fenster - Jeu de montage portes et fenetres - Set di assemblaggio per porte e finestre - Montage set voor deur en raam - Orthez akna ja ukse montaaživahendid	1		

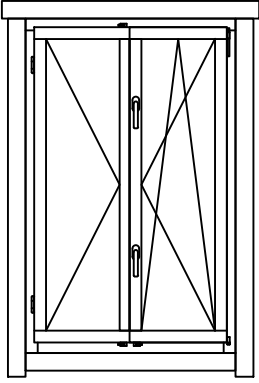
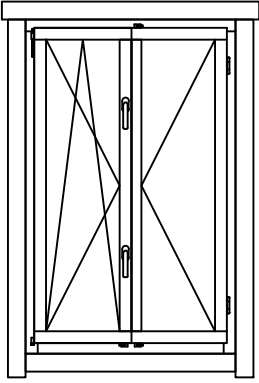
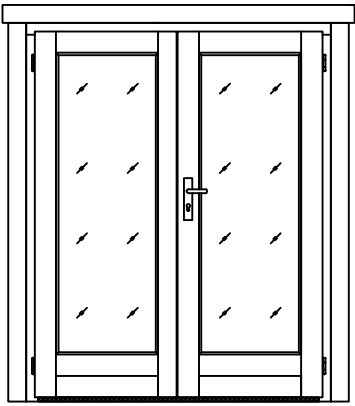
Pos	Dorset 73, Art.No.709702 Piece list - Stückliste - Liste des pièces - Elementi - Stuklijst - Tükítabel	Q	P (mm)	L (mm)
	Window - Fenster - Fenetre - Finestra - Raam - Aken 1100x1729 2+ TA.0P.b 	1		
	Window - Fenster - Fenetre - Finestra - Raam - Aken 1100x1729 2+ TA.0V.b 	1		
	Door - Tür - Porte - Porte - Deur - Uks 1580x1933 2+ TU.10P 	1		

