

Vanessa
Art. Nr.705941

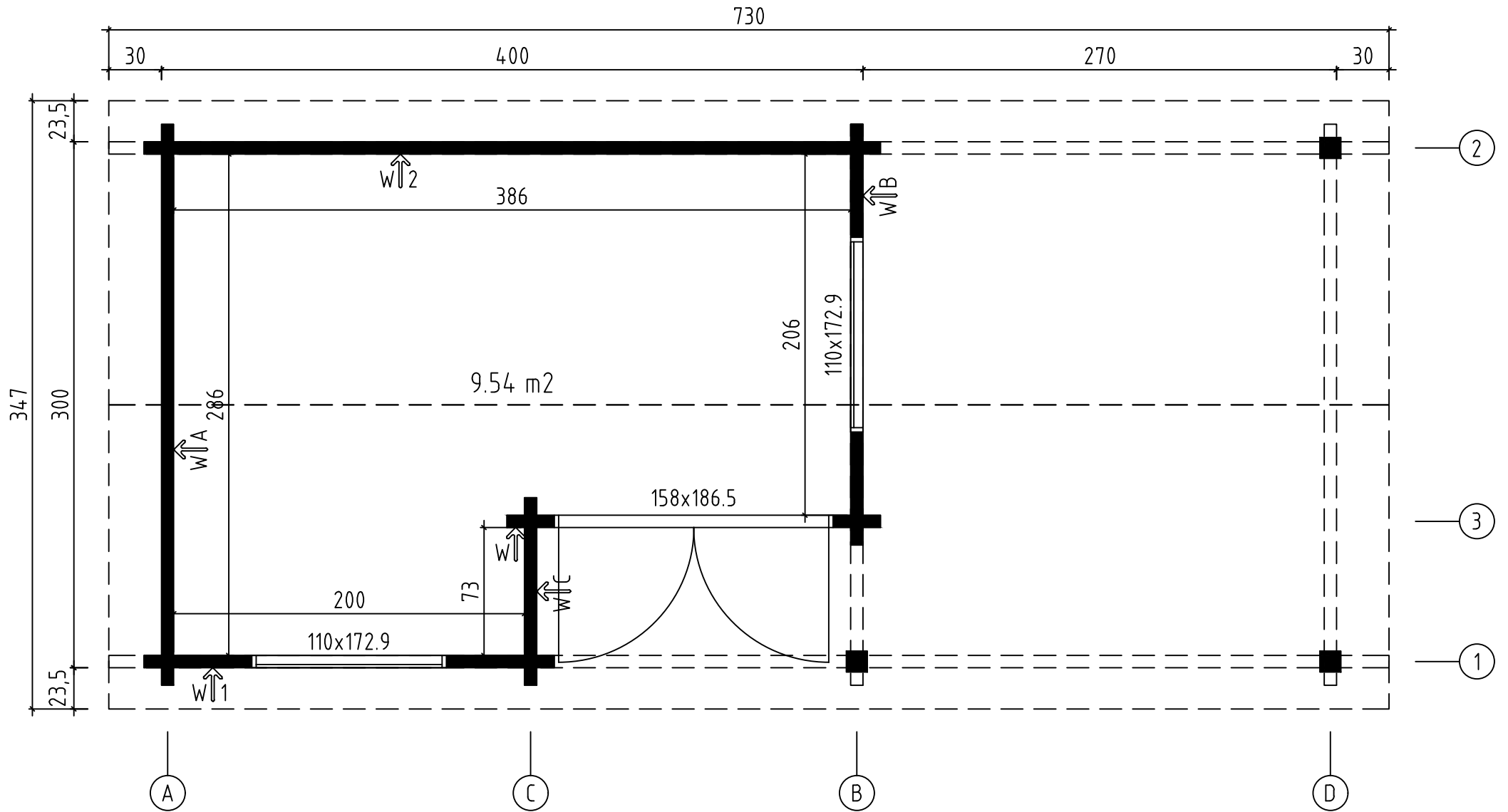

705941 - Vanessa
GROUNDPLAN



705941 - Vanessa
FOUNDATION

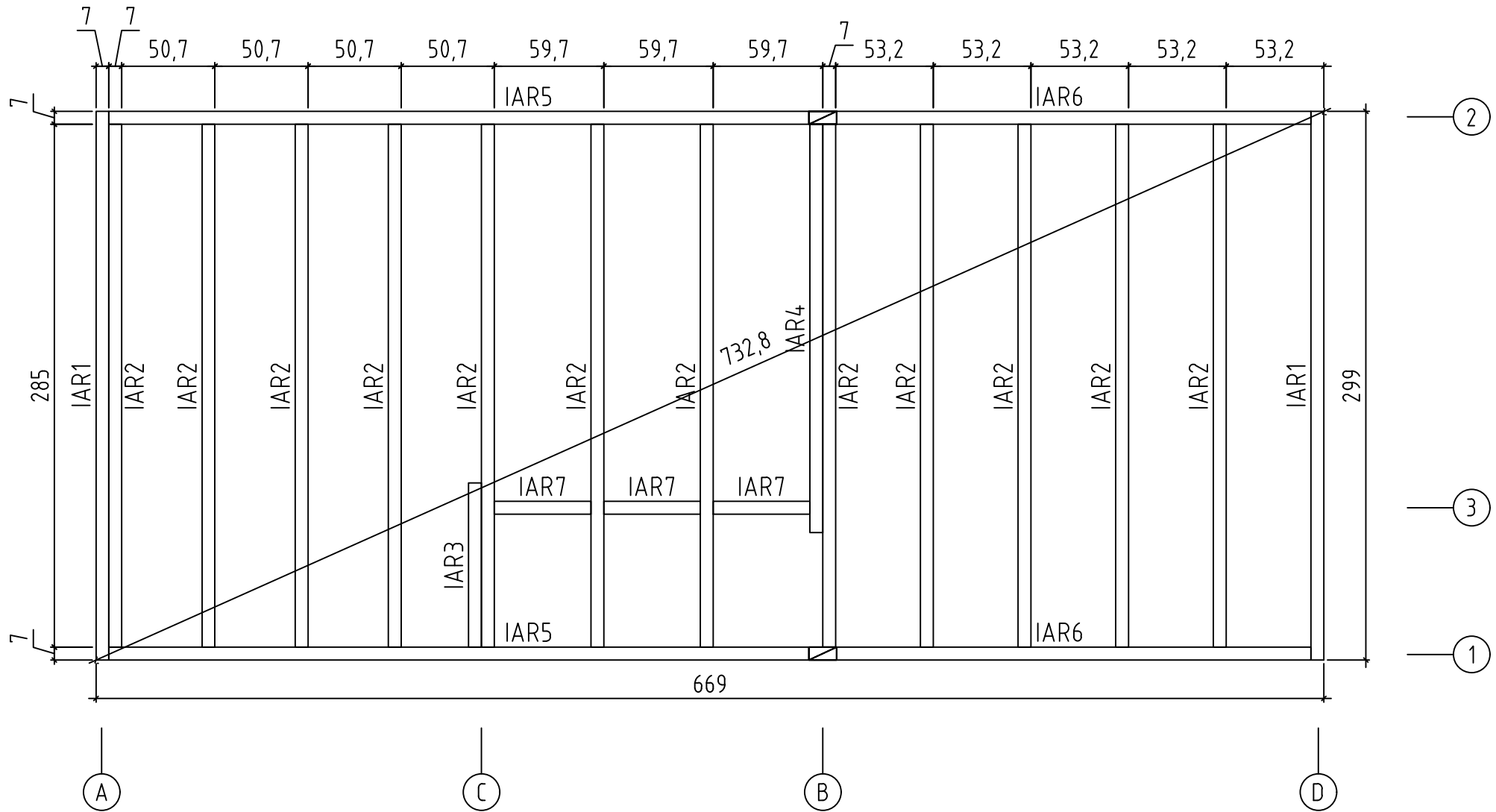

705941 - Vanessa
FLOOR BOARDS
TERRACE BOARDS

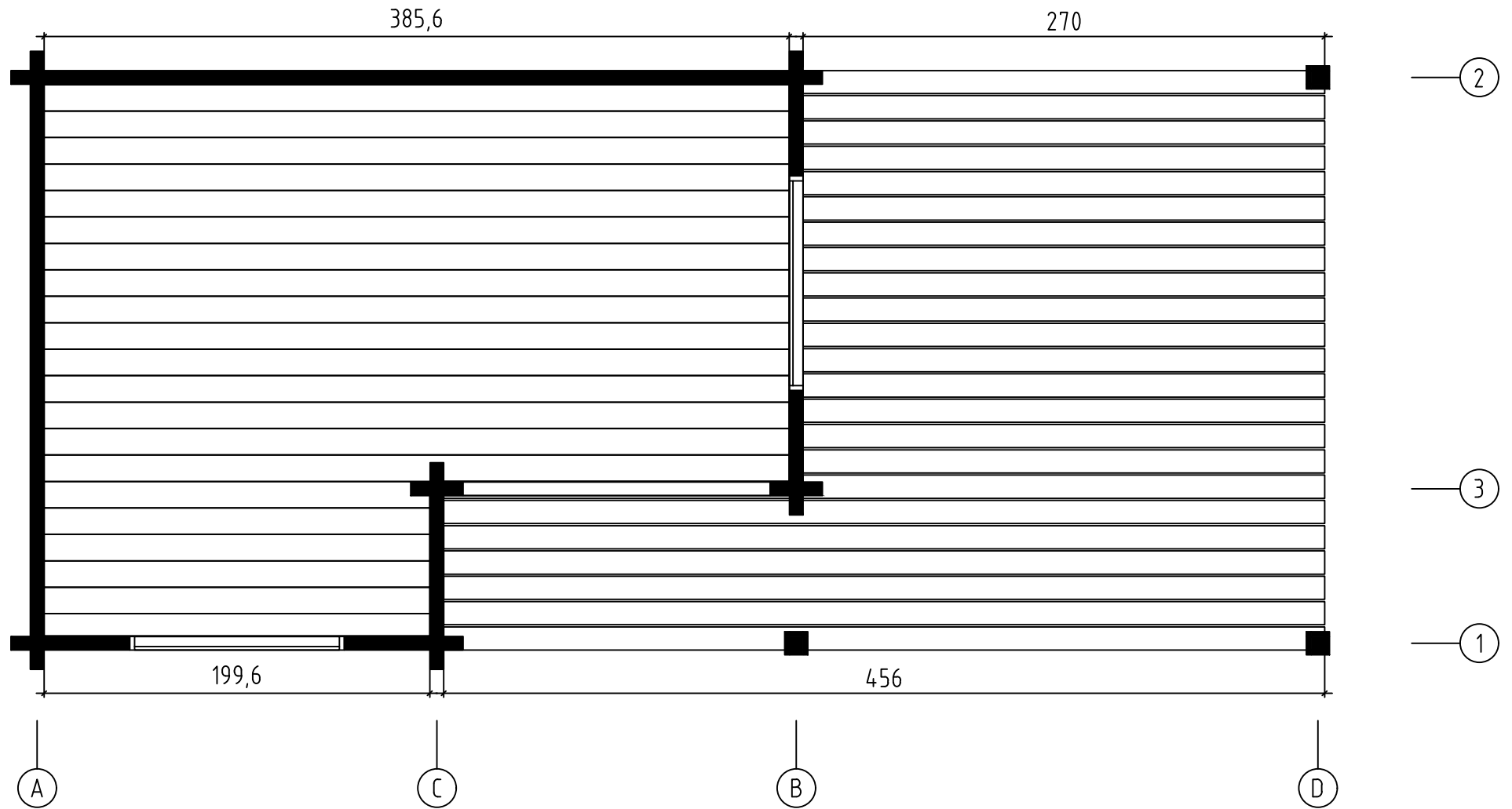



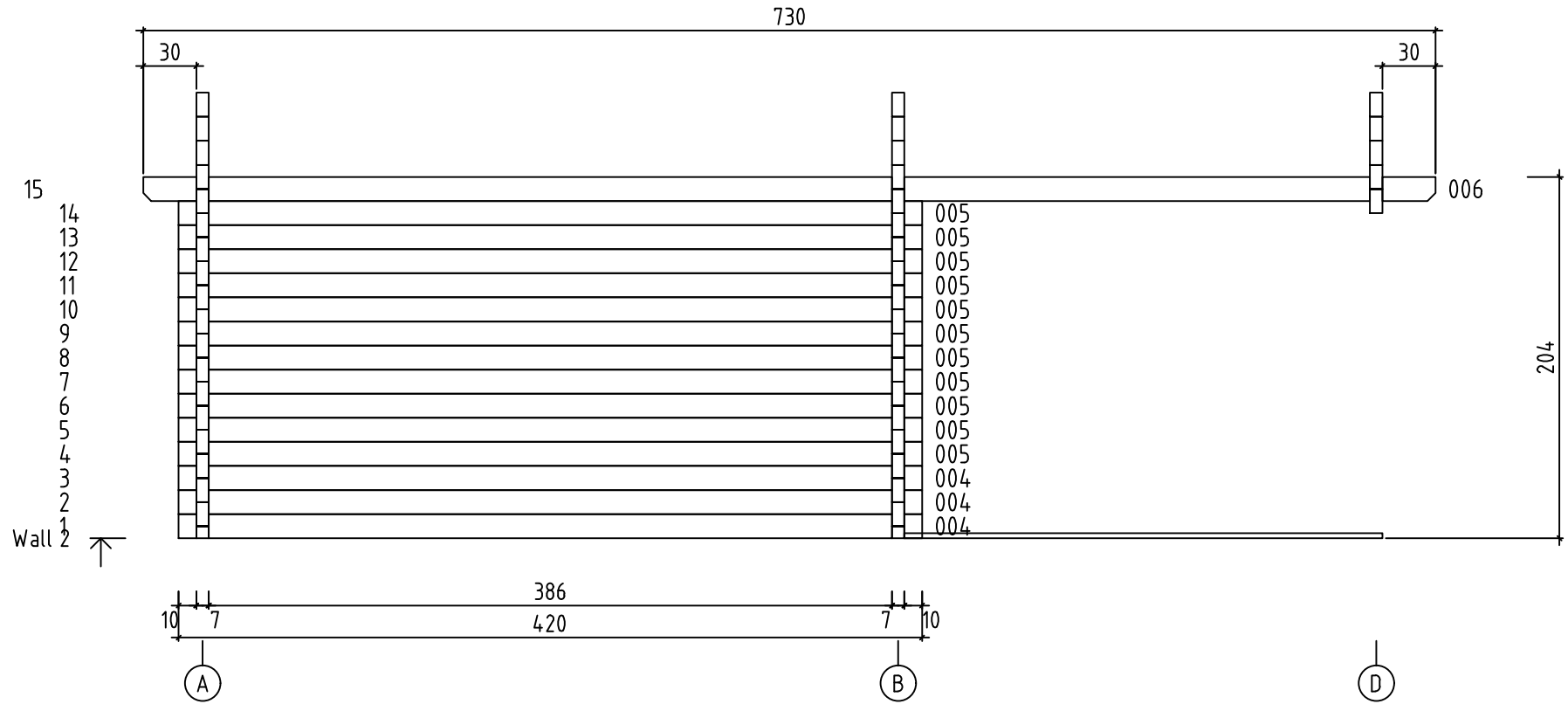



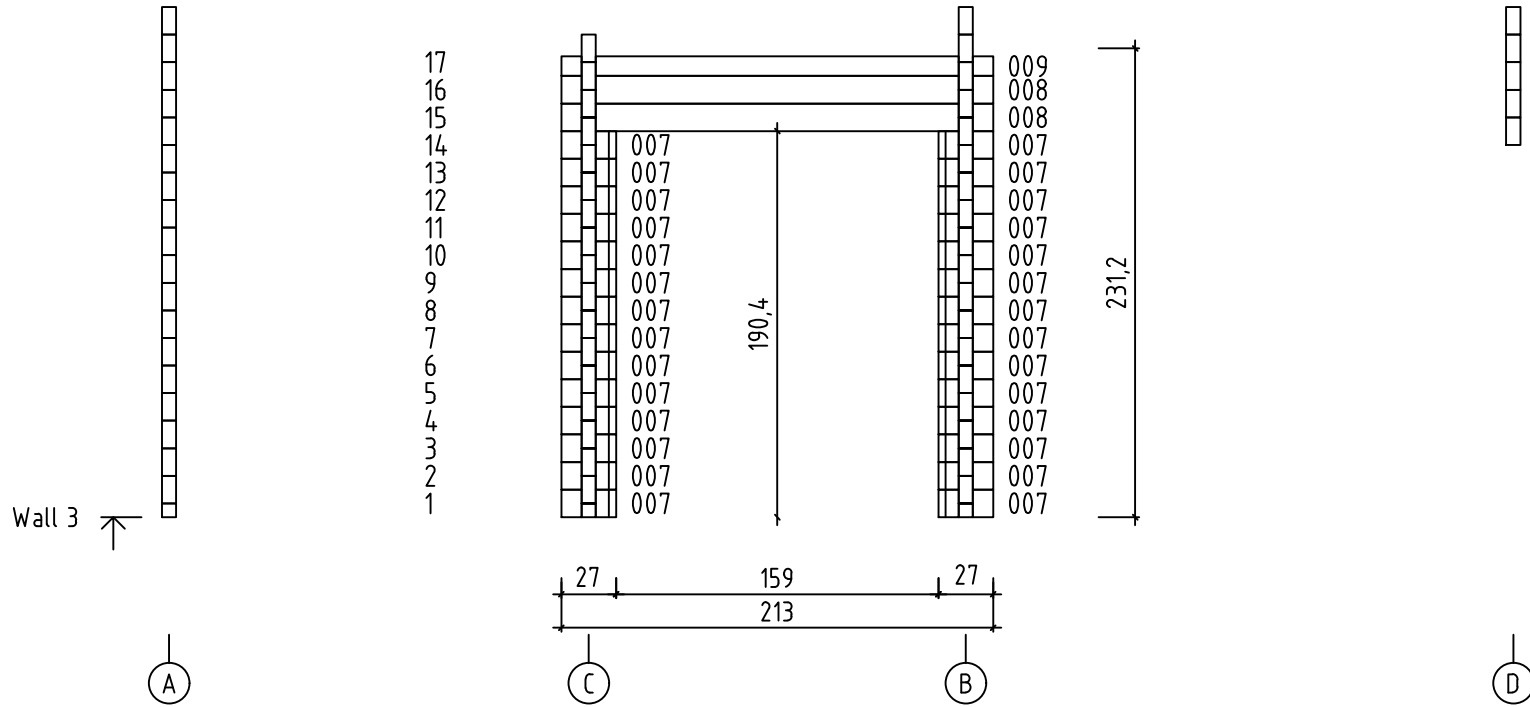

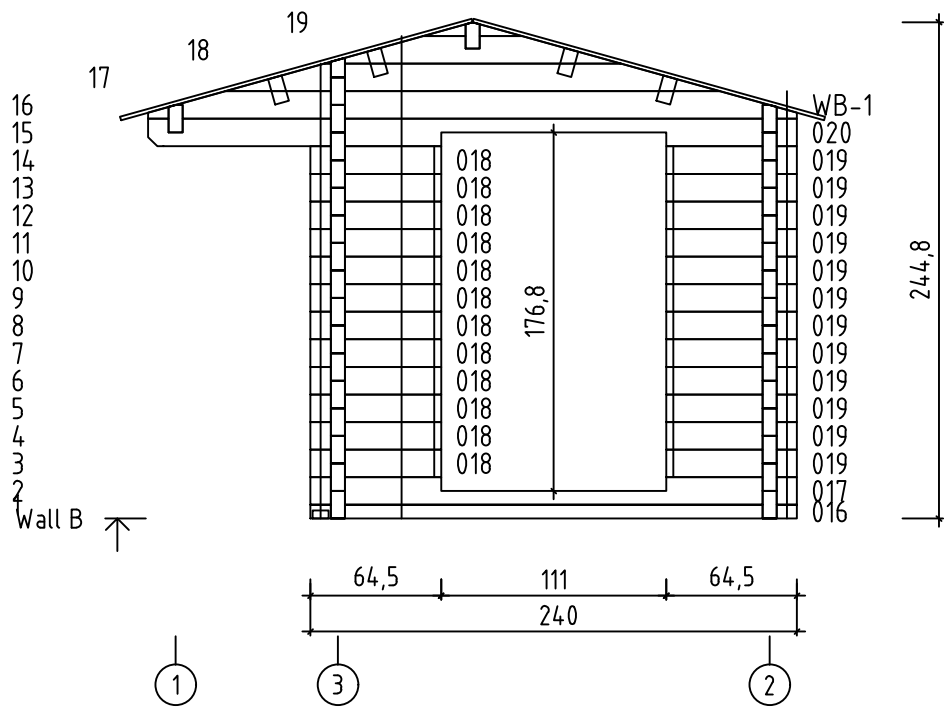
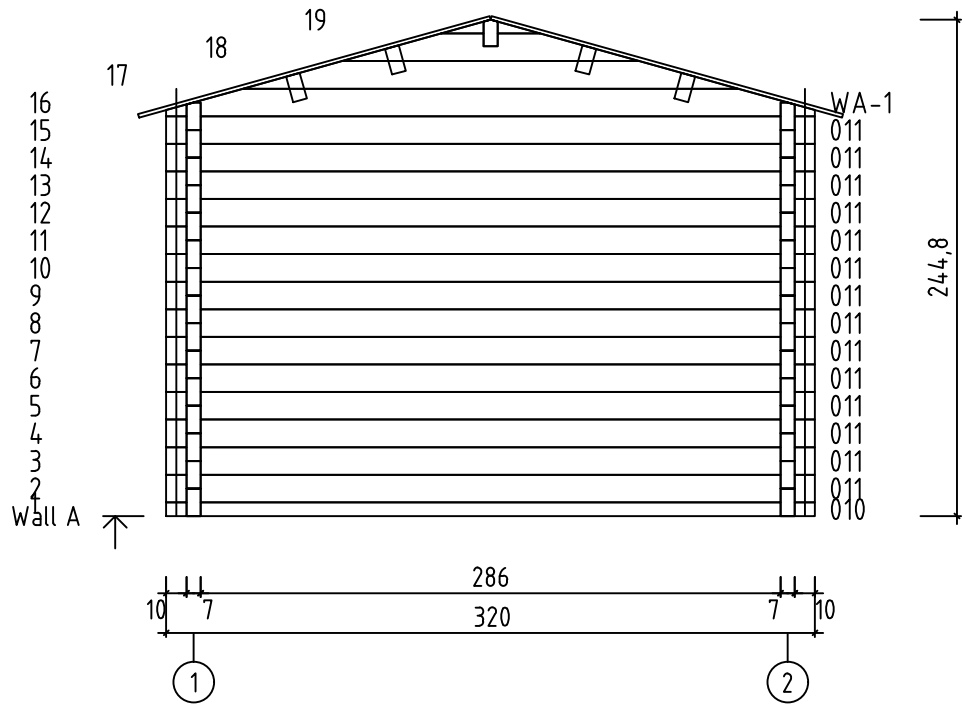
705941 - Vanessa

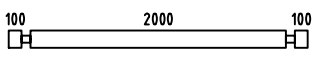

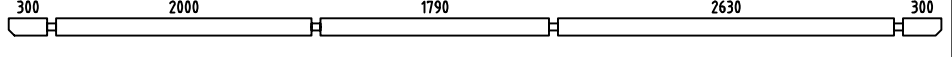
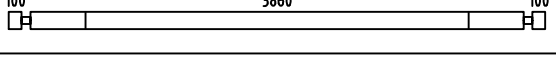
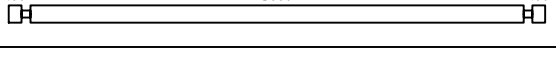
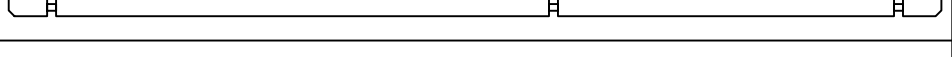

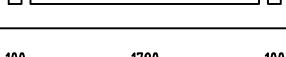
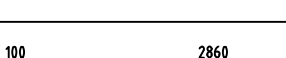
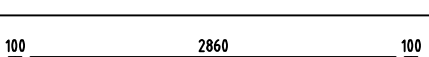
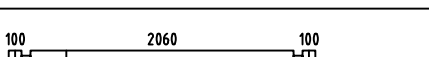
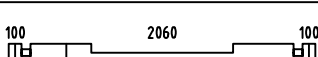



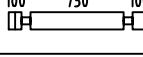
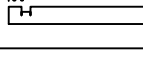
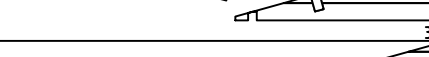
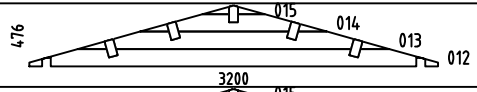
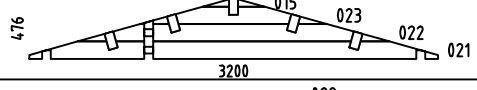
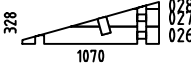
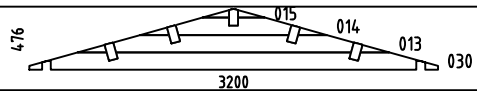
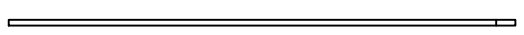
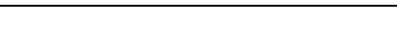



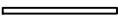

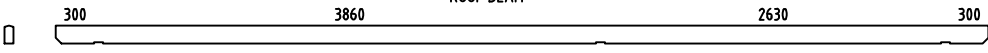
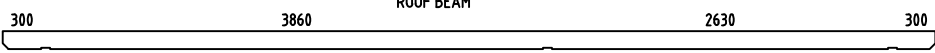







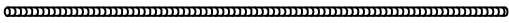

705941 - Vanessa



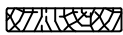

Pos	705941 - Vanessa Piece list	Q.	P (mm)	L (mm)
001		1	70x136	2340
002		26	70x136	615
003		1	70x136	7300
004		3	70x136	4200
005		11	70x136	4200
006		1	70x136	7300
007		28	70x136	270
008		2	70x136	2130
009		1	70x97	2130
010		1	70x68	3200
011		14	70x136	3200
016		1	70x68	2400
017		1	70x136	2400
018		12	70x136	645
019		12	70x136	645
020		1	70x136	3200
024		1	70x68	1070
025		14	70x136	1070
029		1	70x136	3200
WA-1		1		
WB-1		1		
WC-1		1		
WD-1		1		
IAR5		2	70x45	3965
IAR1		2	70x45	2990

Pos	705941 - Vanessa Piece list		Q.	P (mm)	L (mm)
IAR2	FOUNDATION 		12	70x45	2850
IAR6	FOUNDATION 		2	70x45	2735
IAR4	FOUNDATION 		1	70x45	2225
IAR3	FOUNDATION 		1	70x45	895
IAR7	FOUNDATION 		3	70x45	527
PR1		ROOF BEAM	1	70x140	7300
A-PR1		ROOF BEAM	3	70x140	7300
A-PR2		ROOF BEAM	1	70x140	7300
HLL-1	FLOOR BOARDS		16	137x28	3856
HLL-2	FLOOR BOARDS		5	137x28	1996
RB-1	ROOF BOARDS		164	90x18	1800
SV2-1	TERRACE BOARDS		7	120x28	4560
SV2-2	TERRACE BOARDS		16	120x28	2700
FL-1	FLOOR FILLET			18x18	14
DPL-1	ROOFING FELT FILLET		4	18x58	1850
M12-1	TREADED ROD M12		2		45
M12-2	TREADED ROD M12		1		230
M12-3	TREADED ROD M12		5		2000
LPL-1	FIXING FILLET		4	20x70	1060
LPL-2	FIXING FILLET		1	20x70	1540
LPL-3	FIXING FILLET		4	20x70	1729
LPL-4	FIXING FILLET		2	20x70	1865
P-1	POST		3	120x120	1800
TB-1	EAVES BOARD		4	18x120	3650
DRV-1	ROOF EDGE REINFORCEMENT		4	28x34	3650

