

Jari 3
Art.No. 704045

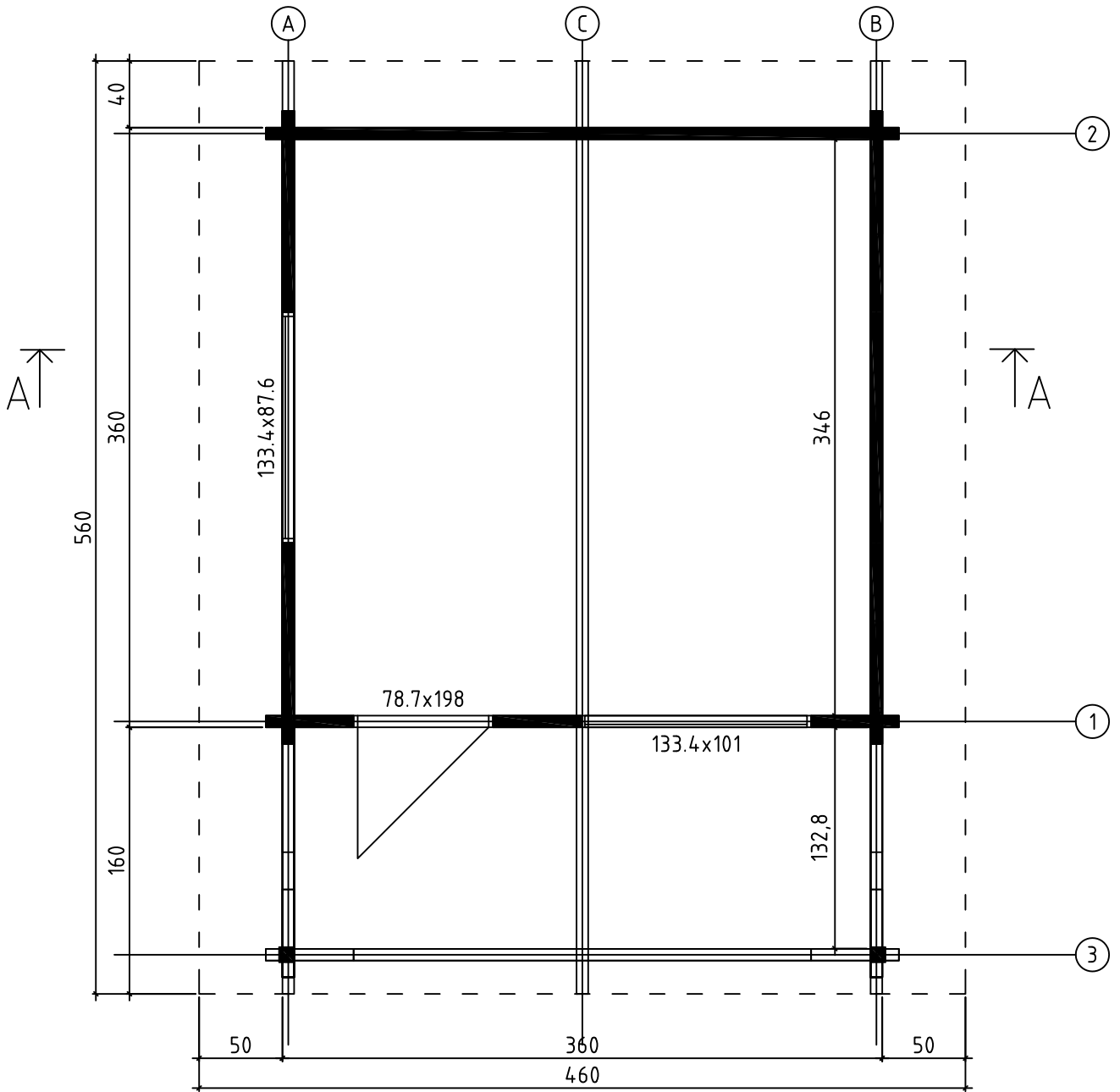

Jari 3 - Art.No.704045
GROUNDPLAN - GRUNDPLAN - PLAN DE MASSE



Jari 3 - Art.No.704045
FOUNDATION - FUNDAMENT - FONDAZION

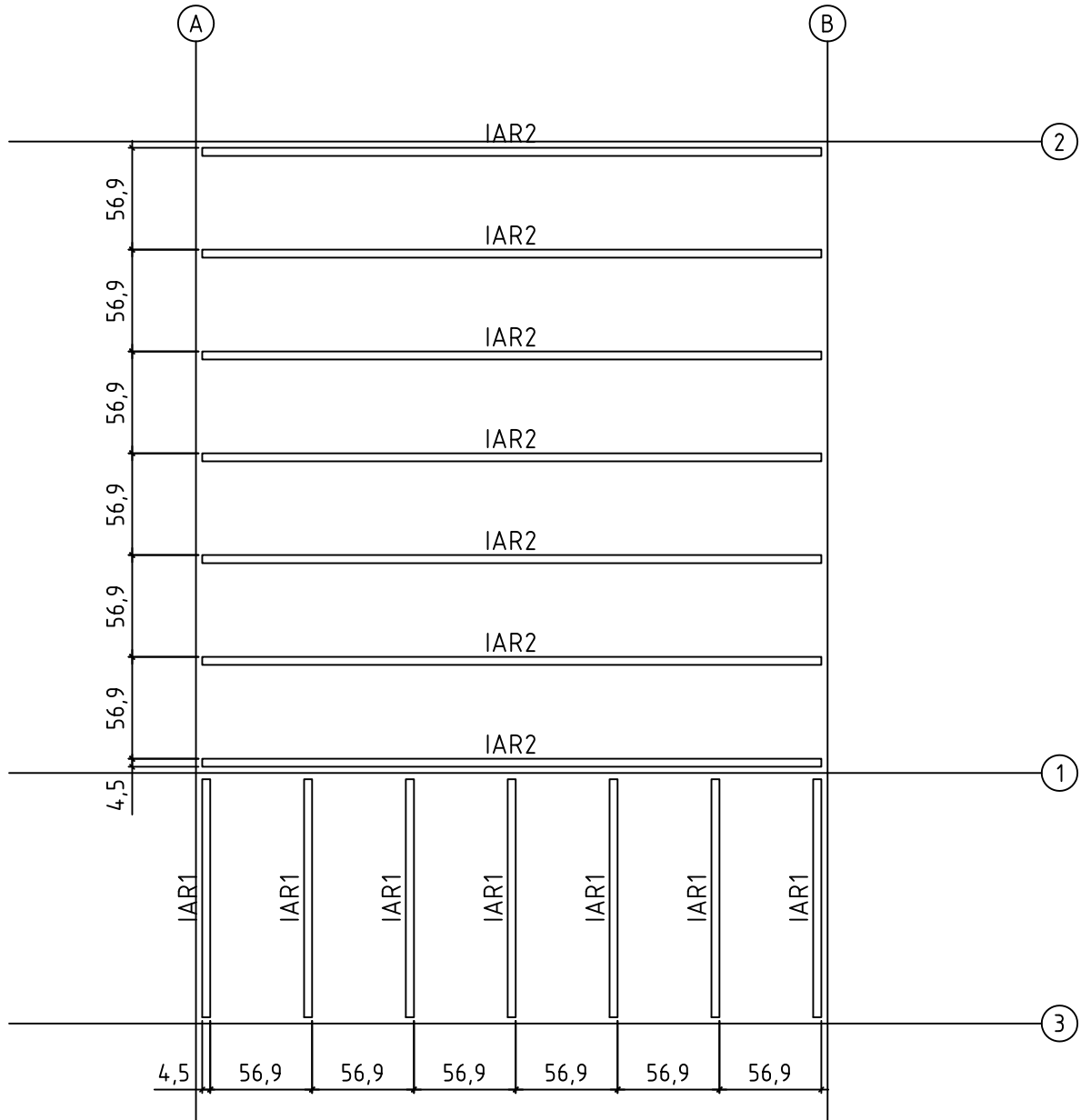

Jari 3 - Art.No.704045
RAFTERS PLAN - DACHSPARREN - PLAN DE CHEVRON

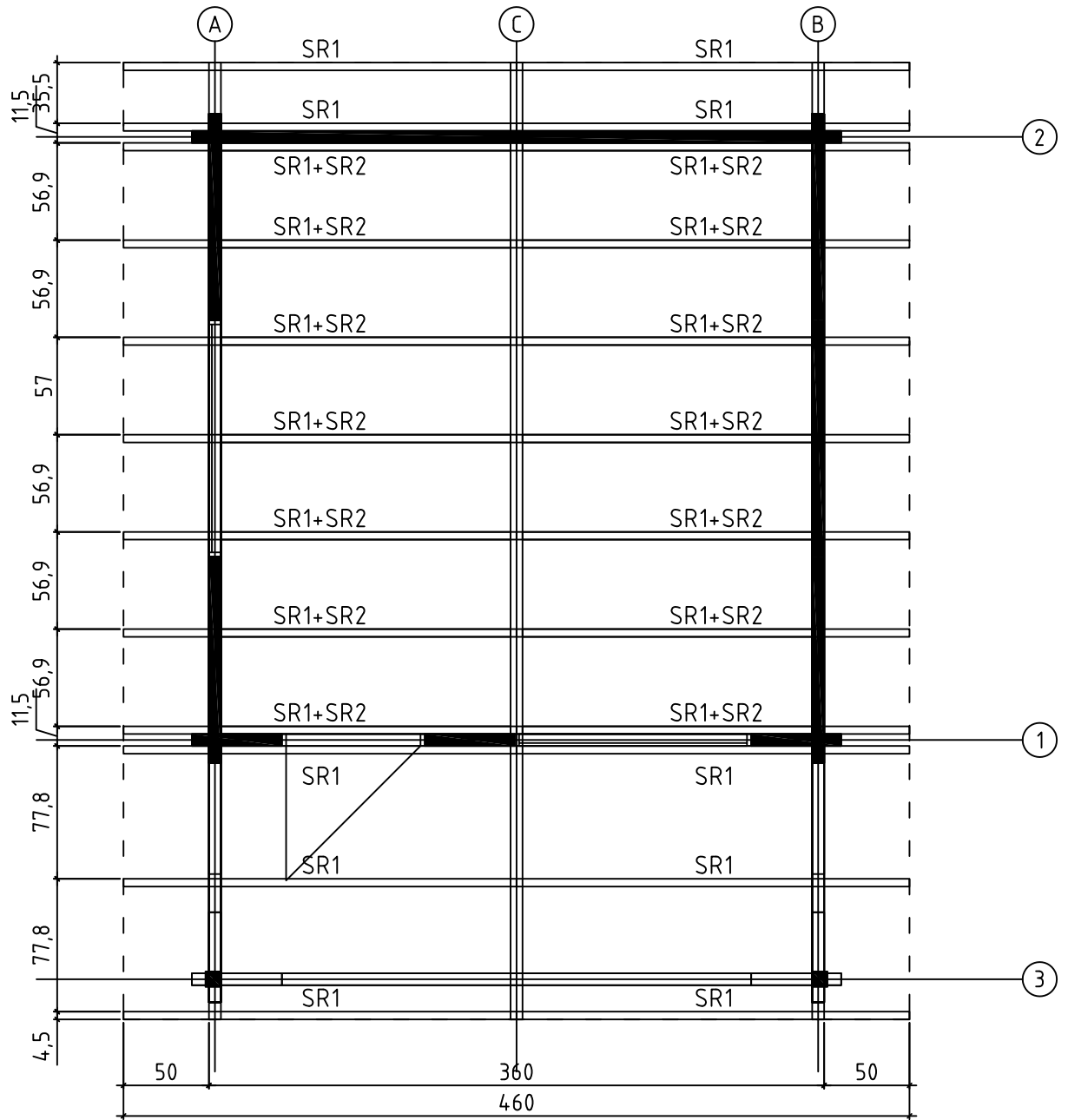



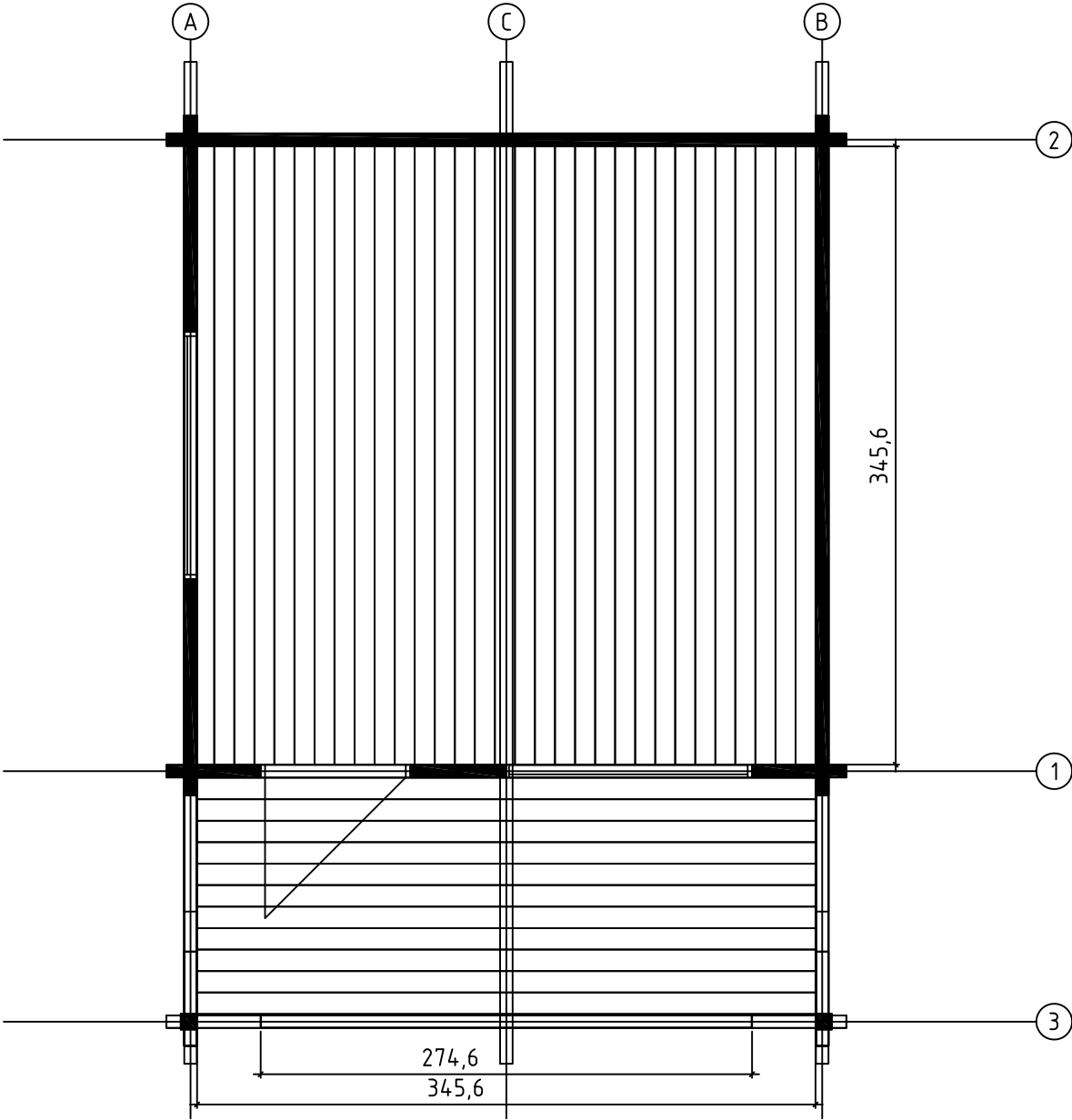

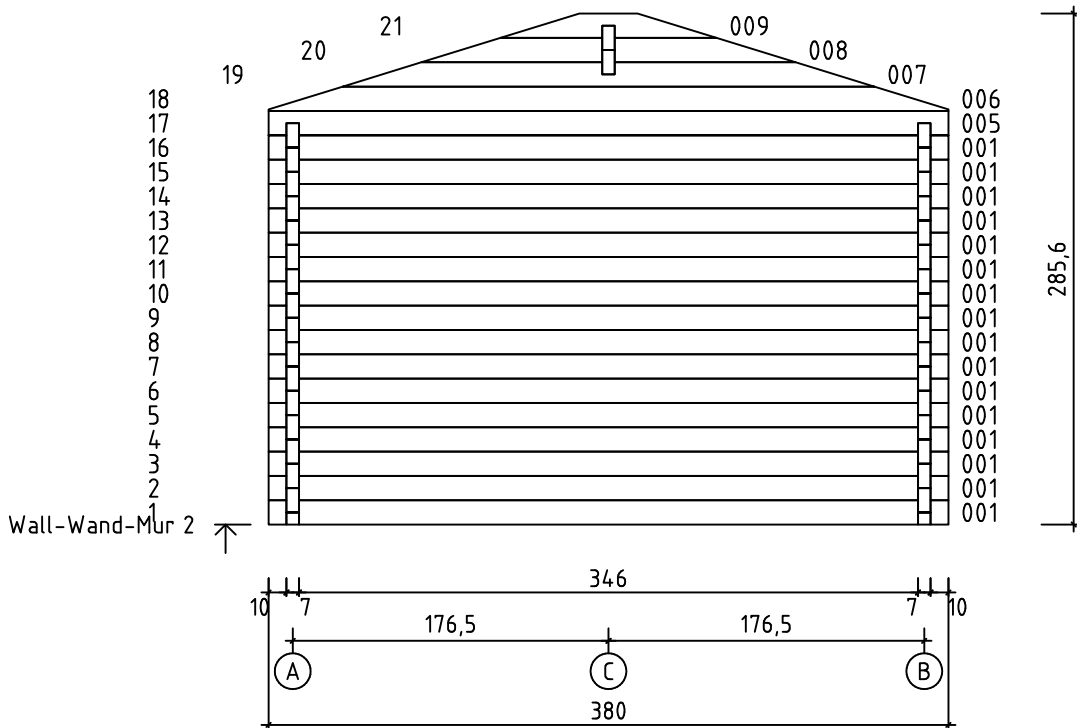
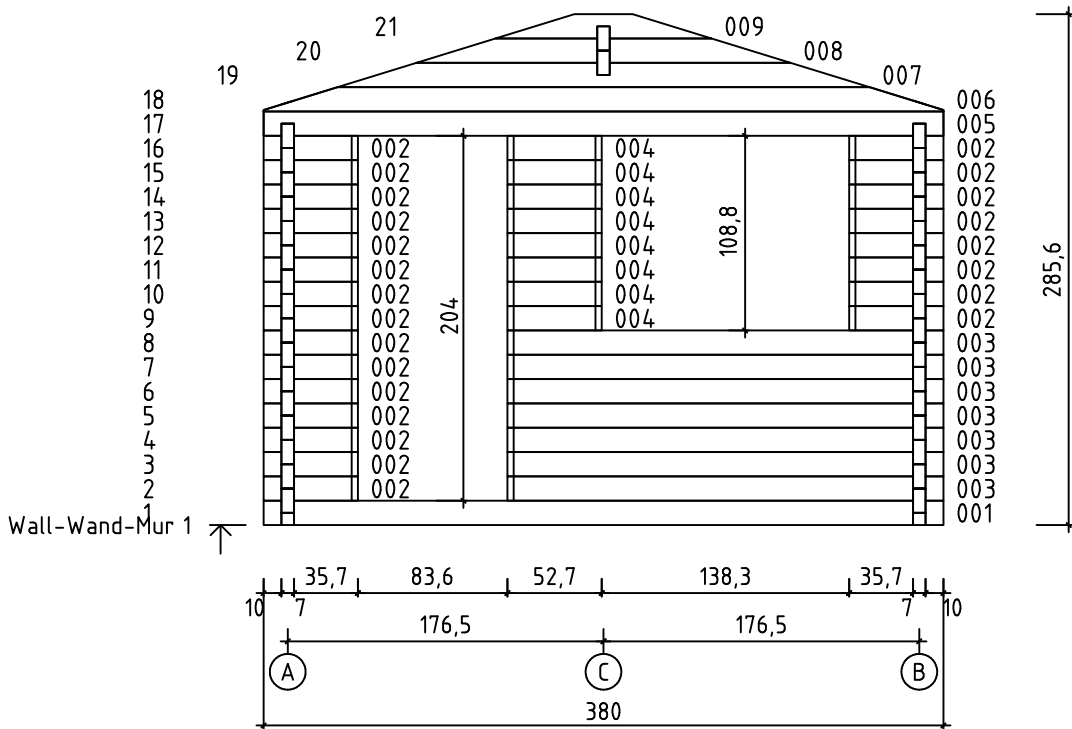

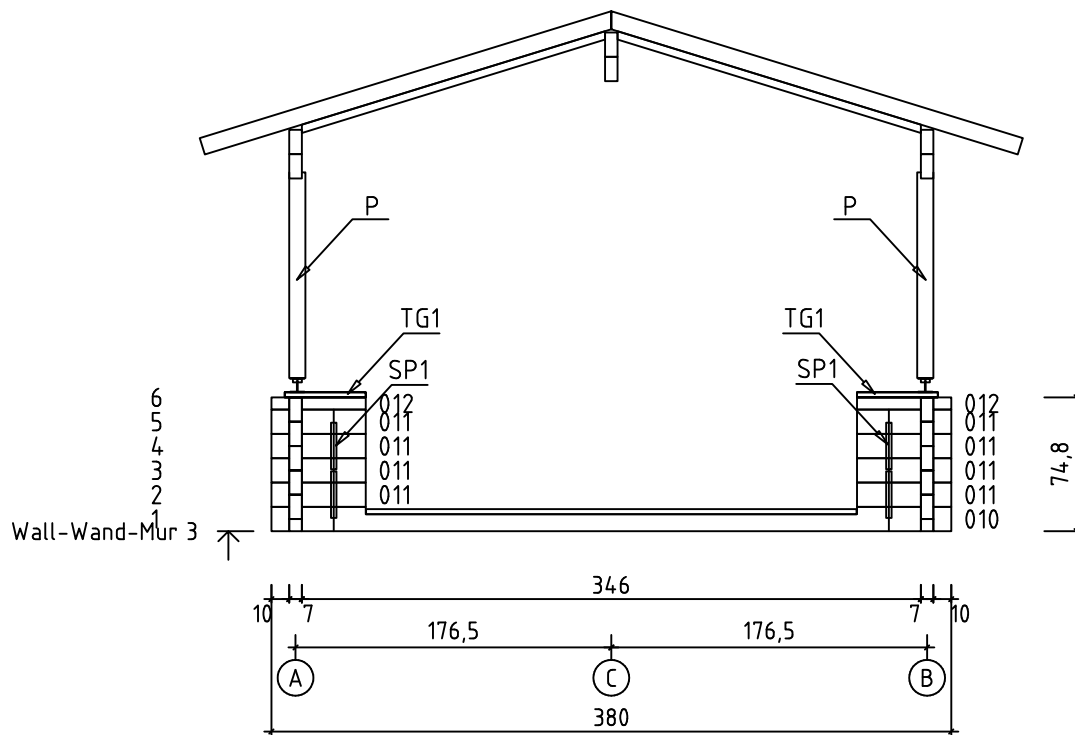
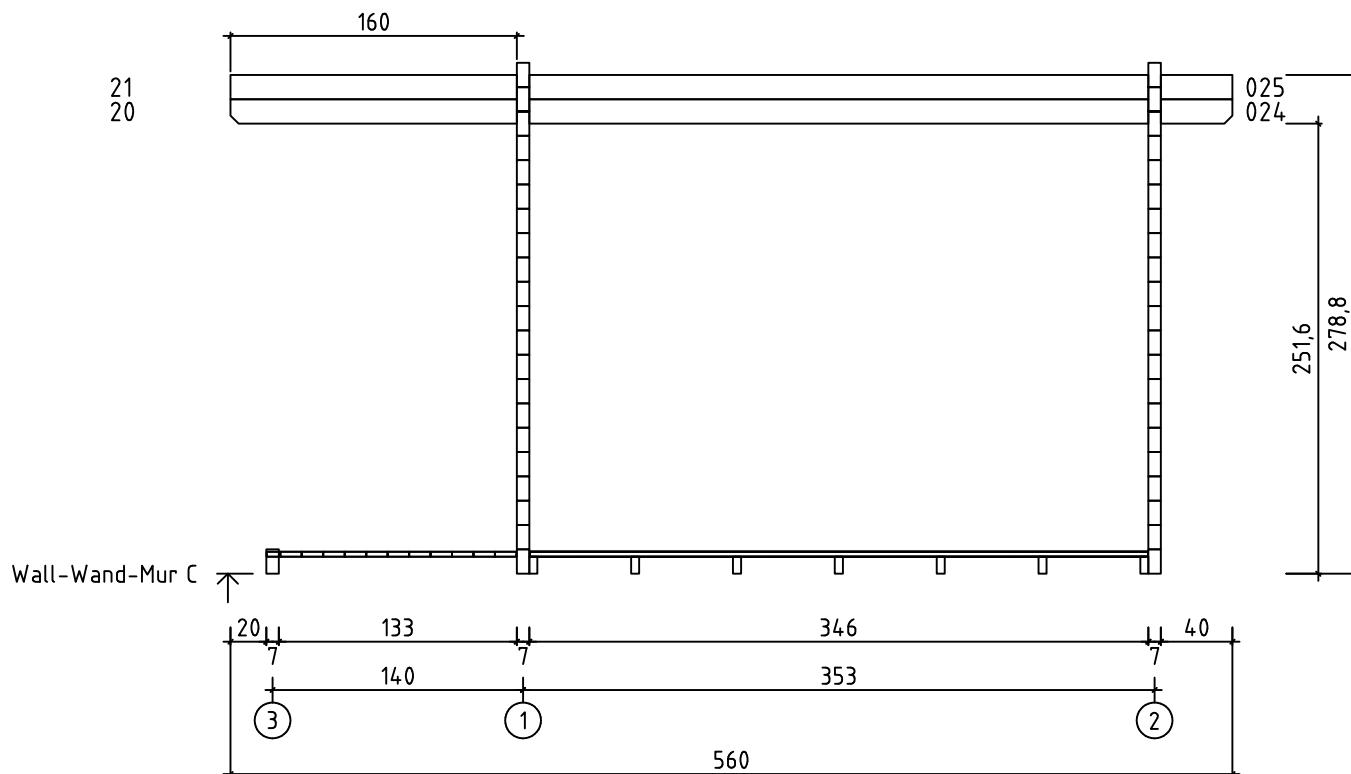

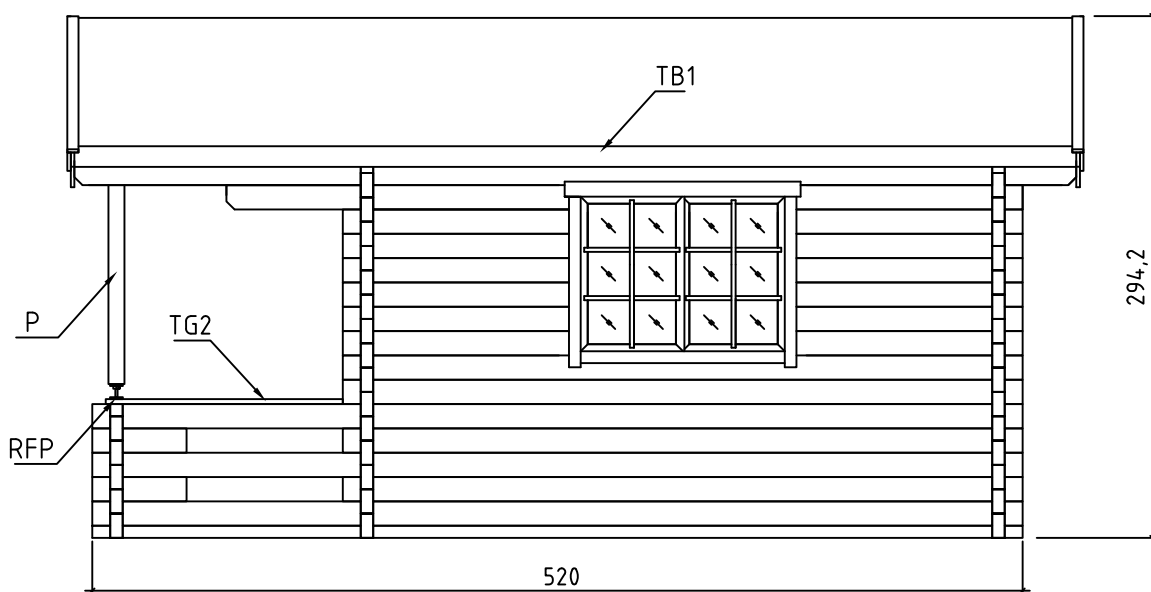
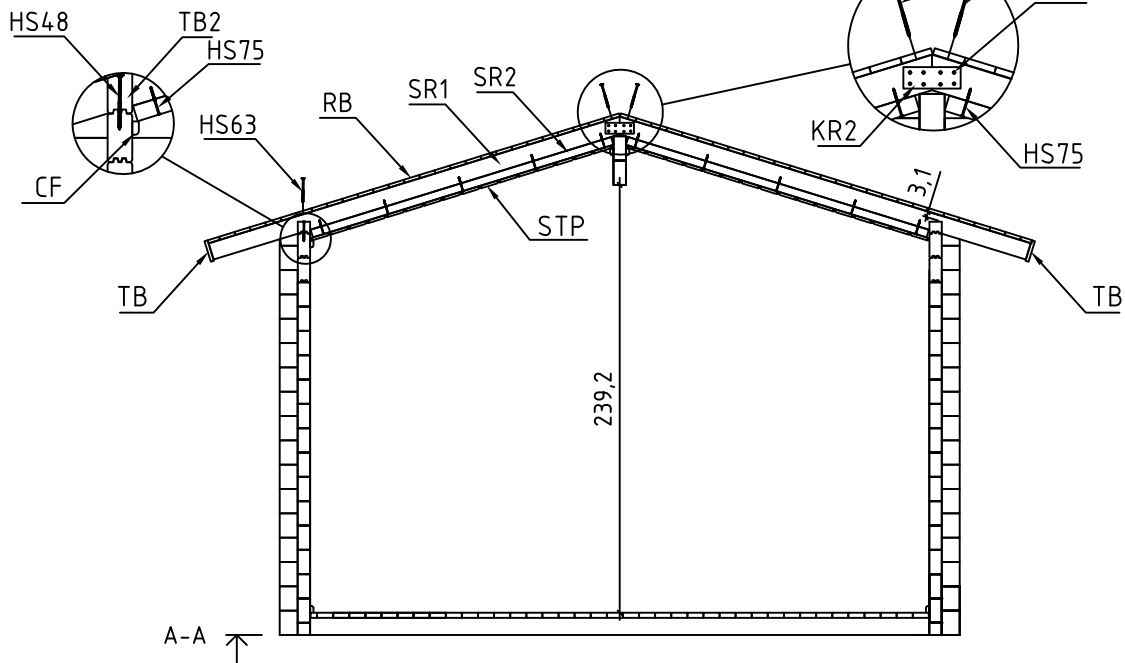
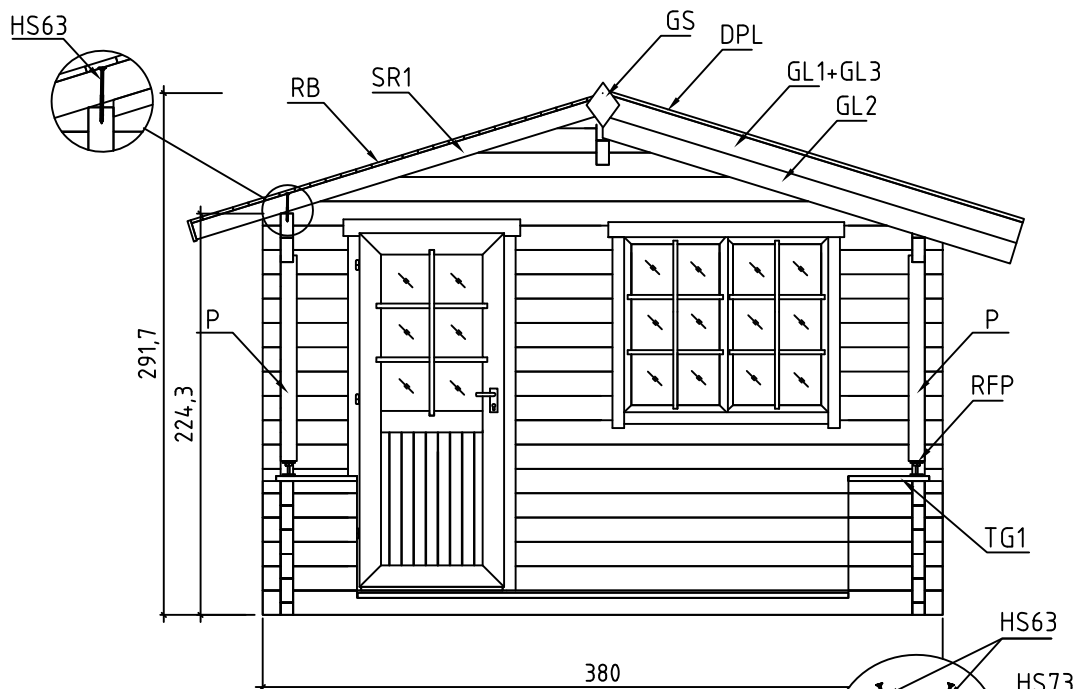
Jari 3 - Art.No.704045
FLOOR BOARDS - FUSSBODENBRETTER - PLAN POSE PLANCHER

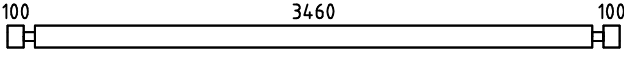

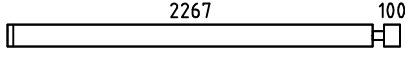

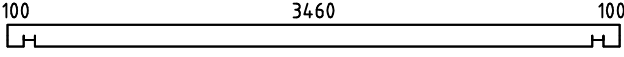
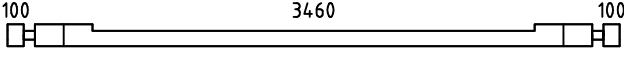

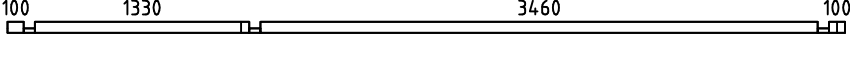
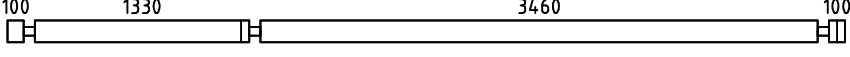

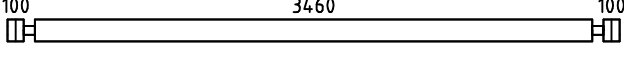
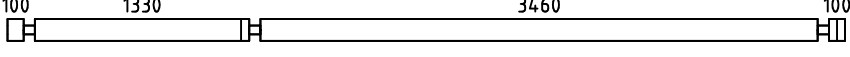
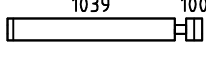
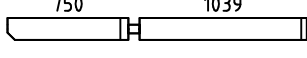
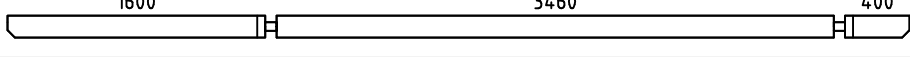
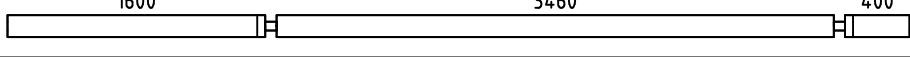
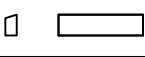
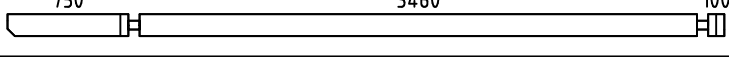
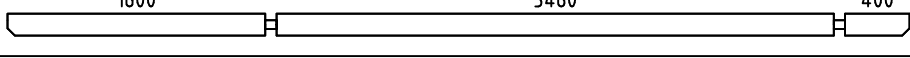
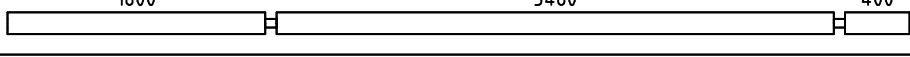
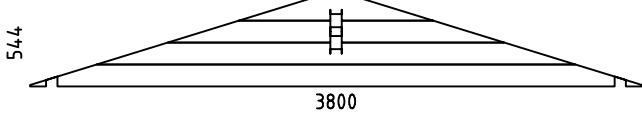
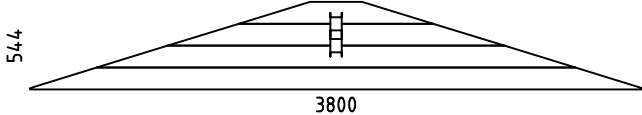

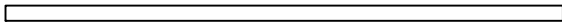
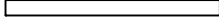
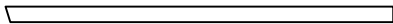
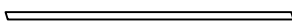























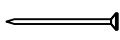
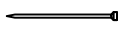

Pos	Jari 3 - Art.No.704045 Piece list - Stückliste - Liste des pieces	Q.	P (mm)	L (mm)
001		17	70x136	3800
002		23	70x136	527
003		7	70x136	2437
004		8	70x136	527
005		2	70x136	3800
010		1	70x136	3800
011		8	70x136	527
012		2	70x68	527
013		2	70x68	5200
014		4	70x136	5200
015		4	70x136	527
016		14	70x136	3800
017		2	70x136	5200
018		13	70x136	1209
019		1	70x136	1859
020		2	70x136	5600
021		2	70x136	5600
022		12	70x129	524
023		1	70x136	4450
024		1	70x136	5600
025		1	70x136	5600
W1-1		1		
W2-1		1		

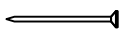
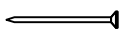
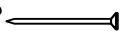
Pos	Jari 3 - Art.No.704045 Piece list - Stückliste - Liste des pieces	Q.	P (mm)	L (mm)
IAR2	FOUNDATION - FUNDAMENT - FONDATION 	7	45x96	3460
IAR1	FOUNDATION - FUNDAMENT - FONDATION 	7	45x96	1330
SR1	RAFTER - DACHSPARREN - CHEVRON 	24	45x96	2407
SR2	RAFTER - DACHSPARREN - CHEVRON 	14	45x45	1788
STP	CEILING BOARDS - DECKENBRETTER - VOLIGES SOUS PLAFOND 	32	111x15	3456
PTL	FLOOR BOARDS - FUSSBODENBRETTER - LAME DE PLANCHER 	31	112x28	3456
RB	ROOF BOARDS - DACHBRETTER - VOLIGES 	54	90x18	5600
	TERRACE BOARDS - TERRASSENBRETTER - PLANCHER DE TERRASSE 	12	120x28	3456
FF	FLOOR FILLET-FUSSBODENLEISTE - CORNIERE DE FINITION DU PLANCHER 		15x40	13.8 m.
CF	CEILING FILLET - DECKELEISTE - PROFIL DE FINITION POUR SOUS PLAFOND 		15x40	20.9 m.
TG1	TERRACE BOARDS - TERRASSENBRETTER - PLANCHER DE TERRASSE 	1+1	28x120	455
TG2	TERRACE BOARDS - TERRASSENBRETTER - PLANCHER DE TERRASSE 	1+1	28x120	1325
DPL	ROOFING FELT FILLET - DACHPAPPENLEISTE - BAGUETTE DE FIXATION DU FEUTRE BITUMEUX 	4	18x58	2462
M12	TREADED ROD M12 - GEWINDESTANGE M12 - TIGE FILETÉE M12 	4		275
M12	TREADED ROD M12 - GEWINDE-STANGE M12 - TIGE FILETÉE M12 	4		2000
LPL	FIXING FILLET - FIXIRUNGSLEISTE - PROFIL DE FIXATION 	1	20x70	787
LPL	FIXING FILLET - FIXIRUNGSLEISTE - PROFIL DE FIXATION 	2	20x70	916
LPL	FIXING FILLET - FIXIRUNGSLEISTE - PROFIL DE FIXATION 	2	20x70	1050
LPL	FIXING FILLET - FIXIRUNGSLEISTE - PROFIL DE FIXATION 	4	20x70	1334
LPL	FIXING FILLET - FIXIRUNGSLEISTE - PROFIL DE FIXATION 	2	20x70	2000
P	POST - PFOSTEN - POTEAU 	2	90x90	1150
TB	EAVES BOARD - TRAUFBRETT - BANDEAU DE TOIT 	2	18x120	5600
TBE6	FIXING FILLET FOR WINDOW - FIXIRUNGSLEISTE FÜR FENSTER - PROFIL DE FIXATION DES FENETRES 	2	28x34	916
TBE6	FIXING FILLET FOR WINDOW - FIXIRUNGSLEISTE FÜR FENSTER - PROFIL DE FIXATION DES FENETRES 	2	28x34	1050
TBE6	FIXING FILLET FOR DOOR - FIXIRUNGSLEISTE FÜR TÜR - PROFIL DE FIXATION DES PORTES 	2	28x34	2000

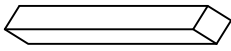
Pos	Jari 3 - Art.No.704045 Piece list - Stückliste - Liste des pieces	Q.	P (mm)	L (mm)
GL3	GABLE MOULDING - GIEBELLEISTE PLANCHE DE RIVE 	4	18x90	2462
GL1	GABLE MOULDING - GIEBELLEISTE PLANCHE DE RIVE 	4	18x120	2435
GL2	GABLE MOULDING - GIEBELLEISTE PLANCHE DE RIVE 	4	18x120	2462
KL4	LENGTHENING BOLT FOR TREADED ROD - VERLÄNGERUNGSMUTTER FÜR GEWINDESTANGE - MANCHON DE RACCORDEMENT DE TIGE FILETÉE 	4		
KL1	DRIVE NUT TREADED ROD - EINSCHLAGMUTTER FÜR GEWINDESTANGE - ÉCROU A FRAPPER POUR TIGE FILITÉE 	4		
KL2	NUT FOR TREADED ROD - MUTTER FÜR GEWINDESTANGE - ÉCROU POUR TIGE FILETÉE 	4		
KL3	PLAIN WASHER TREADED ROD - UNTERLEGSSCHEIBE FÜR GEWINDESTANGE - RONDELLE PLATE POUR TIGE FILETÉE 	4		
HS12	SCREW FOR GABLE SEGMENT - SCHRAUBEN FÜR DECKBLATT - VIS POUR FIXATION LOSANGE DE FINITION 	4	3.5x35	
HS83	SCREW FOR FIXING FILLET - SCHRAUBEN FÜR FIXIRUNGSLEISTE - VIS POUR PROFIL DE FIXATION 	46	3.5x50	
HS32	SCREW FOR EAVES BOARDS - SCHRAUBEN FÜR TRAUFBRETT - VIS DE FIXATION POUR BANDEAU DE TOIT 	40	3.5x50	
HS84	SCREW FOR FIXING FILLET - SCHRAUBEN FÜR FIXIRUNGSLEISTE - VIS POUR PROFIL DE FIXATION 	26	3.5x50	
HS16	SCREW FOR GABLE MOULDING - SCHRAUBEN FÜR GIEBELLEISTE - VIS DE FIXATION POUR PLANCHE DE RIVE 	72	3.5x50	
HS73	SCREW FOR CONNECTING PLATE - SCHRAUBE FÜR ANSCHLUSS- PLATTE - VIS DE FIXATION DES PLAQUES DE CONNEXION 	96	4x40	
HS30	SCREW FOR TERRACE REAR BOARDS - SCHRAUBEN FÜR TERRASSEN- RAND - VIS DE FIXATION POUR MAIN COURANTE DE TERRASSE 	14	4x40	
HS34	SCREW FOR POST - SCHRAUBEN FÜR PFOSTEN - VIS DE FIXATION DES POTEAUX 	4	4x60	
NF3	SCREW FOR TERRACE BOARD - SCHRAUBE FÜR TERRASSENBRETT - VIS POUR LAME DE SEUIL D'ENTRÉE DE TERRASSE 	168	4x60	
HS39	SCREW FOR FUNDAMENT - SCHRAUBEN ZUR BEFESTIGUNG FUNDAMENT - VIS POUR FONDATION 	56	5x90	
HS75	SCREW FOR RAFTER - SCHRAUBEN ZUR BEFESTIGUNG DACH- SPARREN - VIS POUR CHEVRON 	70	5x100	
	SCREW FOR GABLE - SCHRAUBEN FÜR GIEBEL - VIS POUR FIXATION DES PIGNONS 	22	5x120	
HS78	SCREW FOR Pos.012 - SCHRAUBEN Für Pos.012 - VIS POUR Pos.012 	24	5x120	
HS63	SCREW FOR RAFTER - SCHRAUBEN ZUR BEFESTIGUNG DACH- SPARREN - VIS POUR CHEVRON 	48	6x150	
HS48	SCREW FOR Pos.022 - SCHRAUBEN Für Pos.022 - VIS POUR Pos.022 	24	6x180	
HS49	SCREW FOR POST HEIGHT ADJUSTMENT - SCHRAUBEN FÜR REGULIERUNGSSCHRAUBE FÜR PFOSTEN - VIS DE FIXATION DE SUPPORT RÉGLABLE DE POTEAU 	16	6x50	
MS	SCREW FOR DOORSTEP - SCHRAUBEN FÜR TÜRSCHWELLE - VIS DE FIXATION DU SEUIL DE PORTE 	2	4.5x65	
SH70	HAMMER BLOCK - SCHLAGHOLZ - CALLE DE FRAPPE 	1		

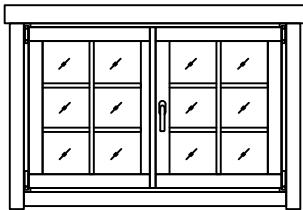
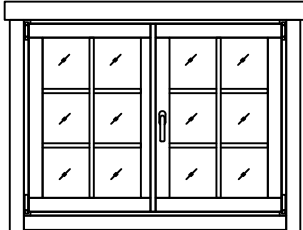
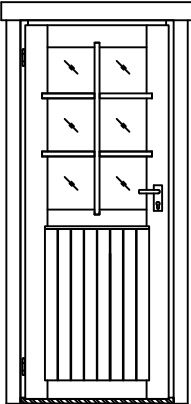
Pos	Jari 3 - Art.No.704045 Piece list - Stückliste - Liste des pieces	Q.	P (mm)	L (mm)
NFD	ZN NAIL FOR ROOFING FELT FILLET - ZN NÄGEL FÜR DACHPAPPEN-LEISTE - POINTE POUR BAGUETTE FIXATION FEUTRE BITUMEUX 	24	2x40	
NFC	ZN NAIL FOR CEILING FILLETS - ZN NÄGEL FÜR DECKENLEISTEN - POINTE POUR CORNIERE 	42	1.4x40	
NFF	ZN NAIL FOR FLOOR FILLETS - ZN NÄGEL FÜR FUSSBODENLEISTEN - POINTE POUR PANNEAUX DE PLANCHER 	28	1.4x40	
NF2	ZN NAIL FOR ROOF - ZN NÄGEL FÜR DACHBRETTER - POINTE POUR TOIT 	578	2x50	
NF2	ZN NAIL FOR CEILING BOARDS - ZN NÄGEL FÜR DECKENBRETTER - CLOUS POUR VOLIGES SOUS PLAFONDS 	238	2x50	
NH1	ZN NAIL FOR FLOOR - ZN NÄGEL FÜR FUSSBODENBRETTER - CLOUS POUR PLANCHER 	230	2x50	
KR2	CONNECTING PLATE - ANSCHLUSSPLATTE - PLAQUE MÉTALLIQUE DE CONNEXION 	12		
GS	GABLE SEGMENT-DECKBLATT - LOSANGE DE FINITION 	2		
SP1	HIDDEN FIXING - HOLZDÜBEL - TOURILLON BOIS 	4		
RFP	POST HEIGHT ADJUSTMENT - REGULIERUNGSSCHRAUBE FÜR PFOSTEN - SUPPORT RÉGLABLE DE POTEAU 	2		
ORZ	MONTAGE SET FOR DOORS AND WINDOWS - MONTAGE-SET FÜR TÜREN UND FENSTER - JEU DE MONTAGE PORTES ET FENETRES	1		
3+ T A.6P	WINDOW-FENSTER-FENETRE 1374x916 	1		
3+ TA .6P.a	WINDOW-FENSTER-FENETRE 1374x1050 	1		
2+ U. 26V.b	DOOR-TÜR-PORTE 827x2000 	1		

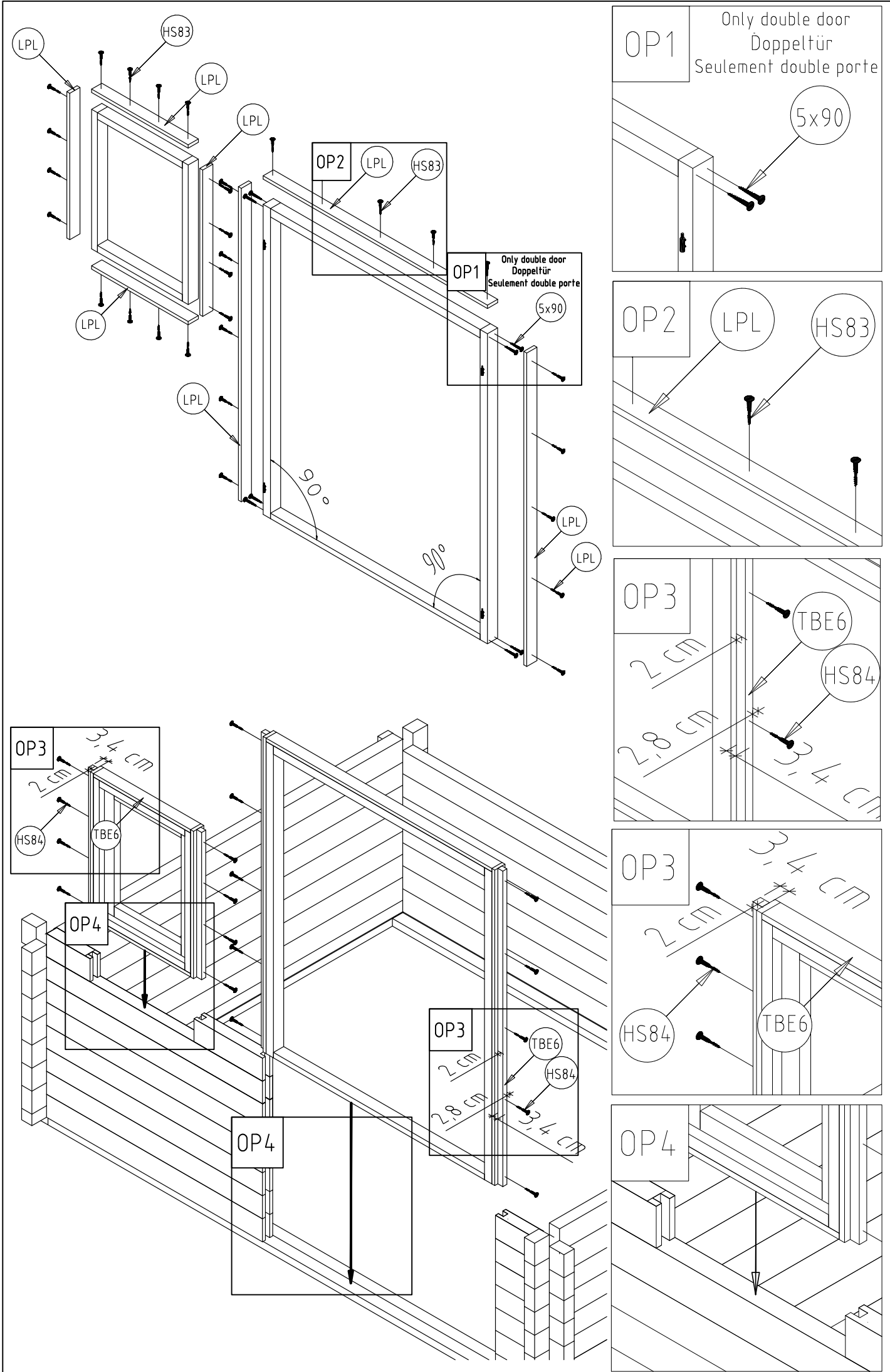

OP1 Only double door
Doppeltür
Seulement double porte

