

Jari
Art. Nr.703541

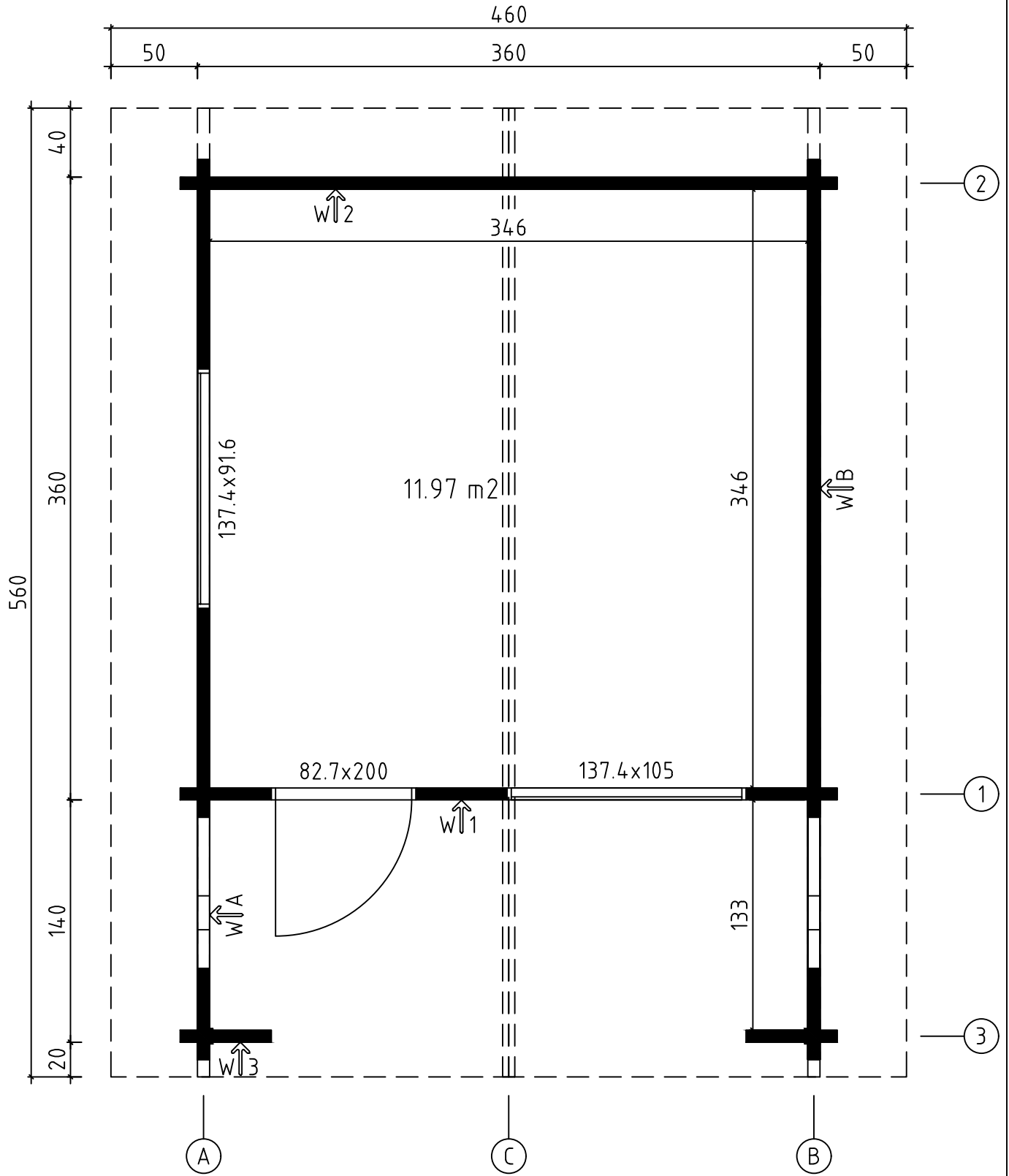

703541 - Jari
GROUNDPLAN - GRUNDPLAN - PLAN DE MASSE



703541 - Jari
FOUNDATION - FUNDAMENT - FONDATION

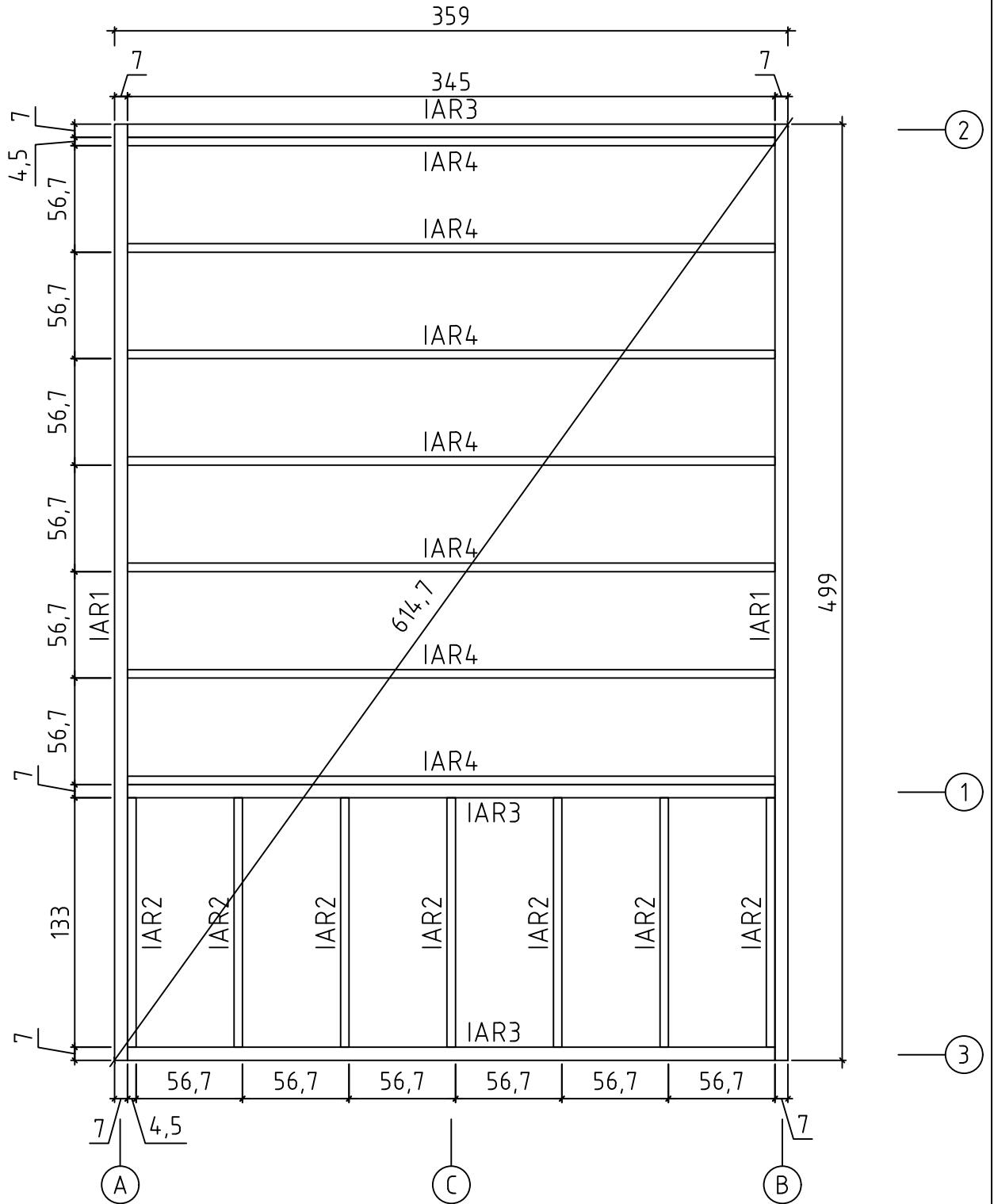

703541 - Jari
RAFTER - DACHSPARREN - CHEVRON

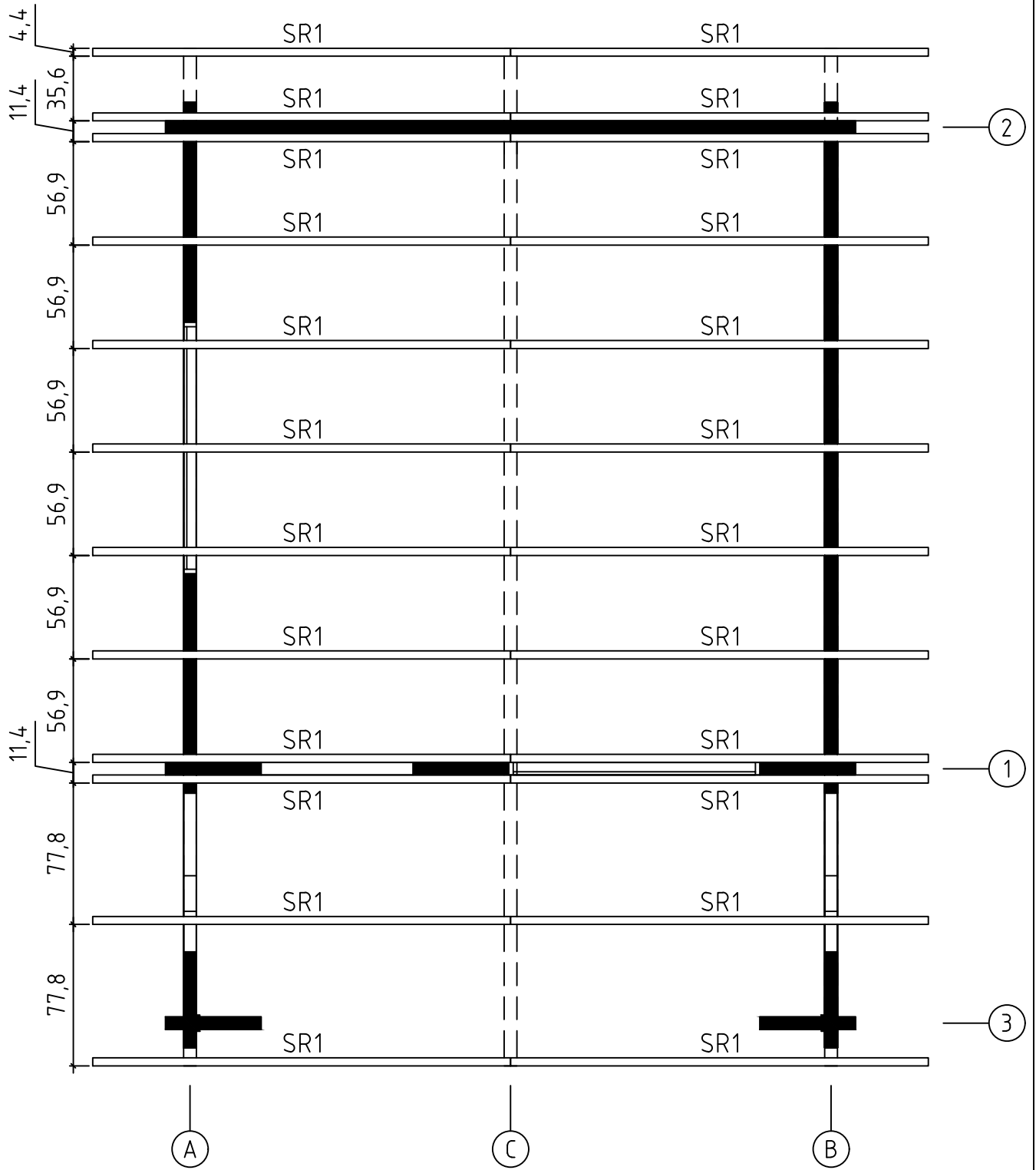

703541 - Jari
FLOOR BOARDS - FUSSBODENBRETTER - LAME DE PLANCHER
TERRACE BOARDS - TERRASSENBRETTER - PLANCHER DE TERRASSE

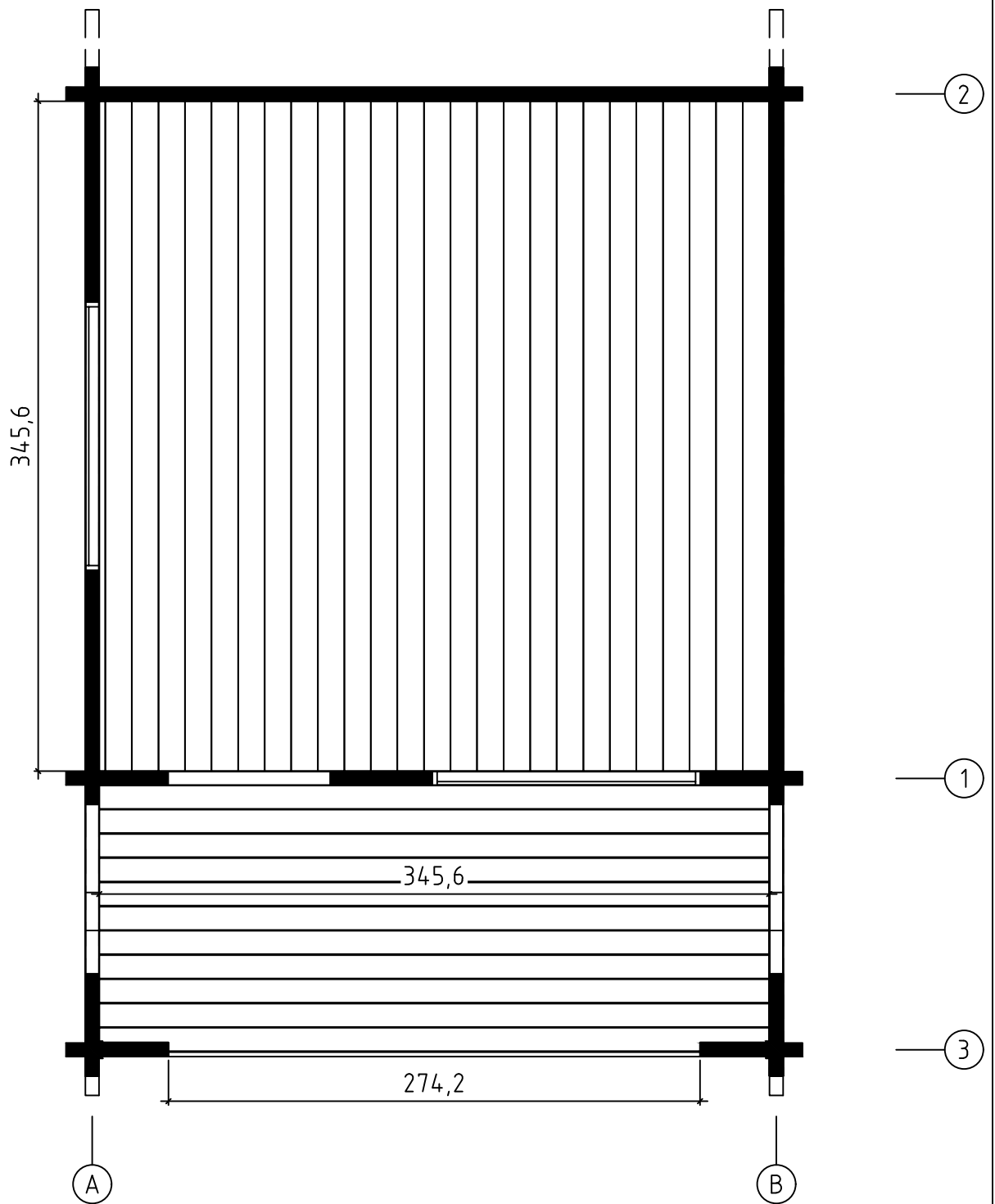

703541 - Jari
CEILING BOARDS - DECKENBRETTER - VOLIGES SOUS PLAFOND

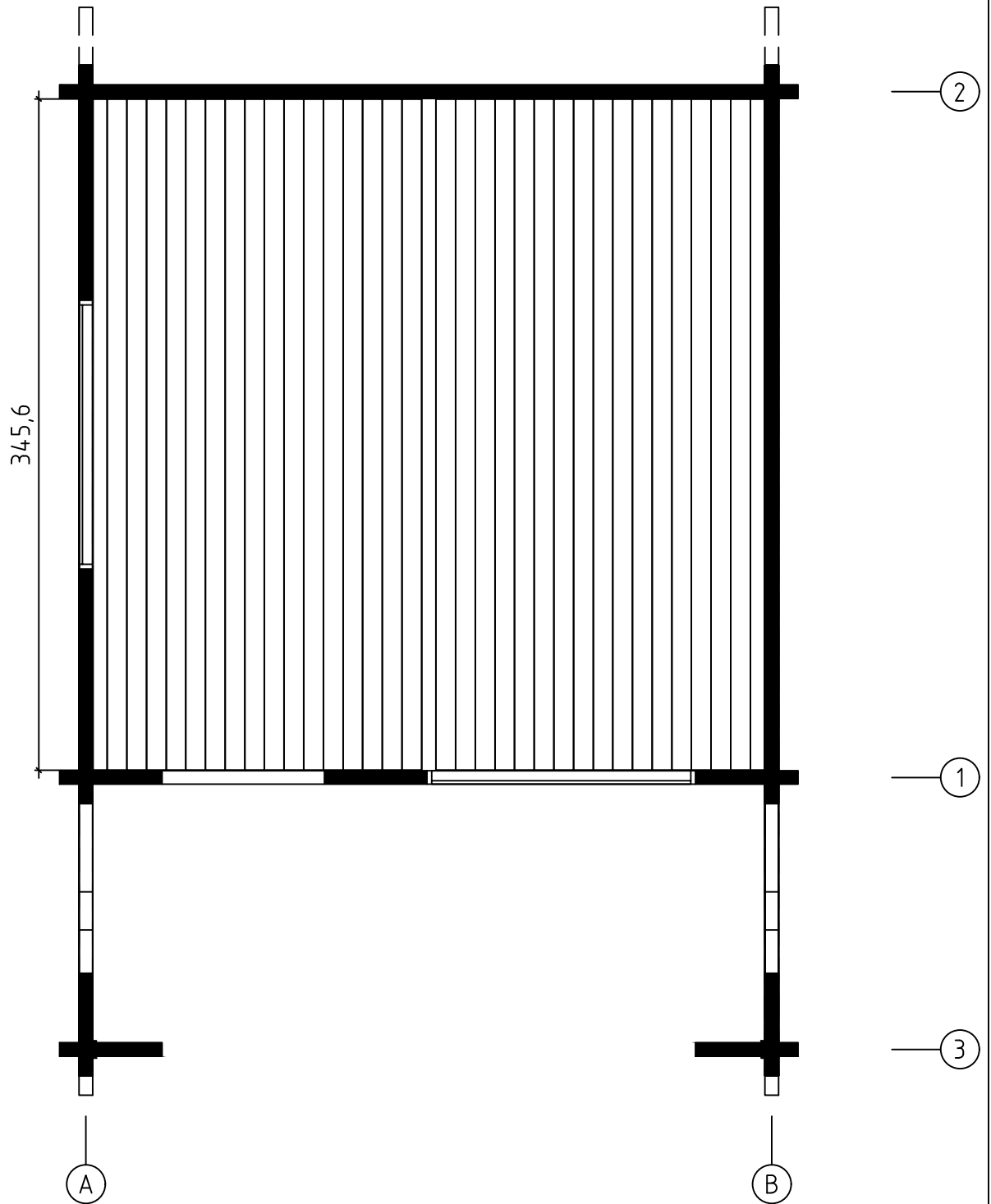

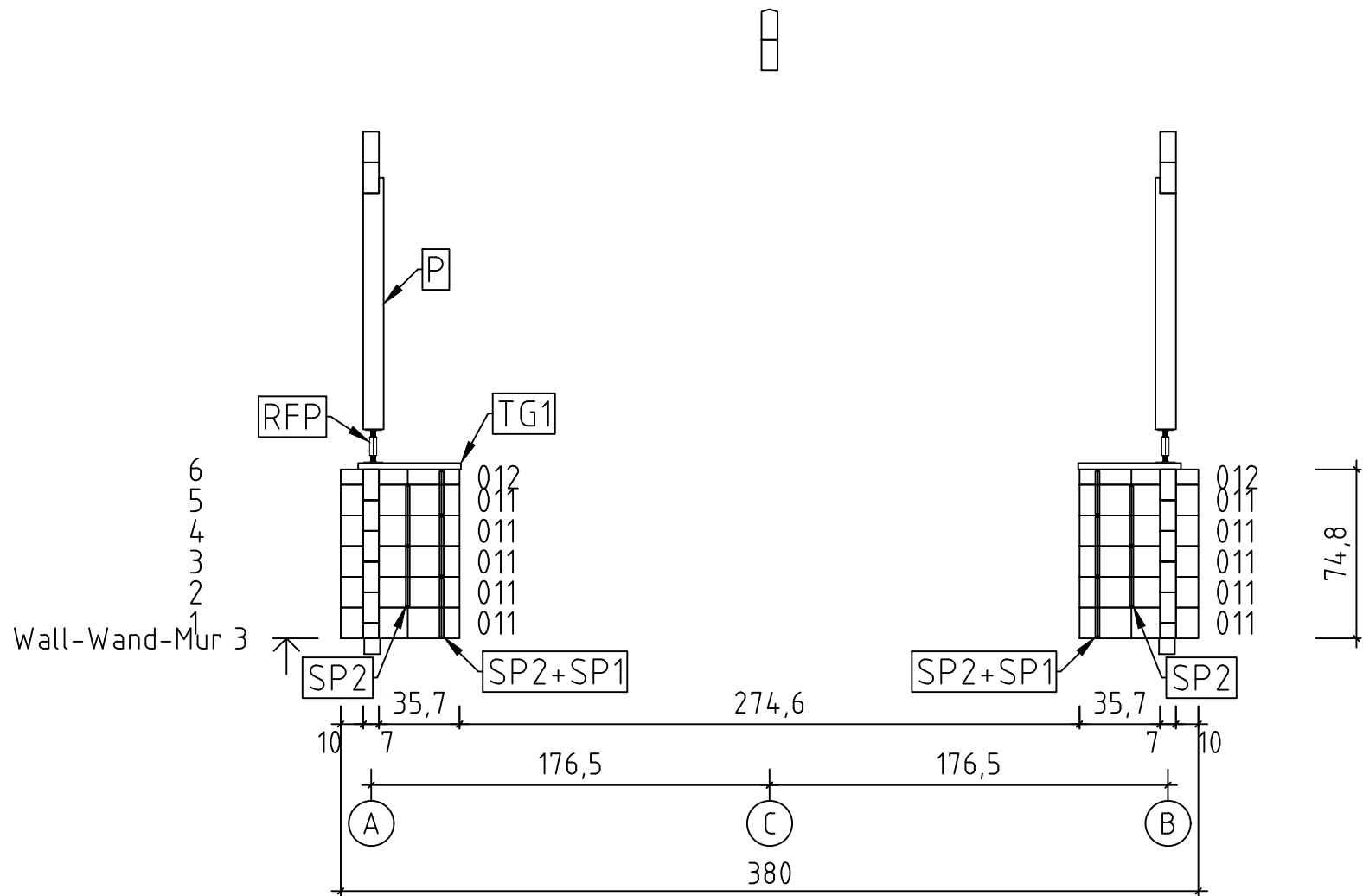

703541 - Jari

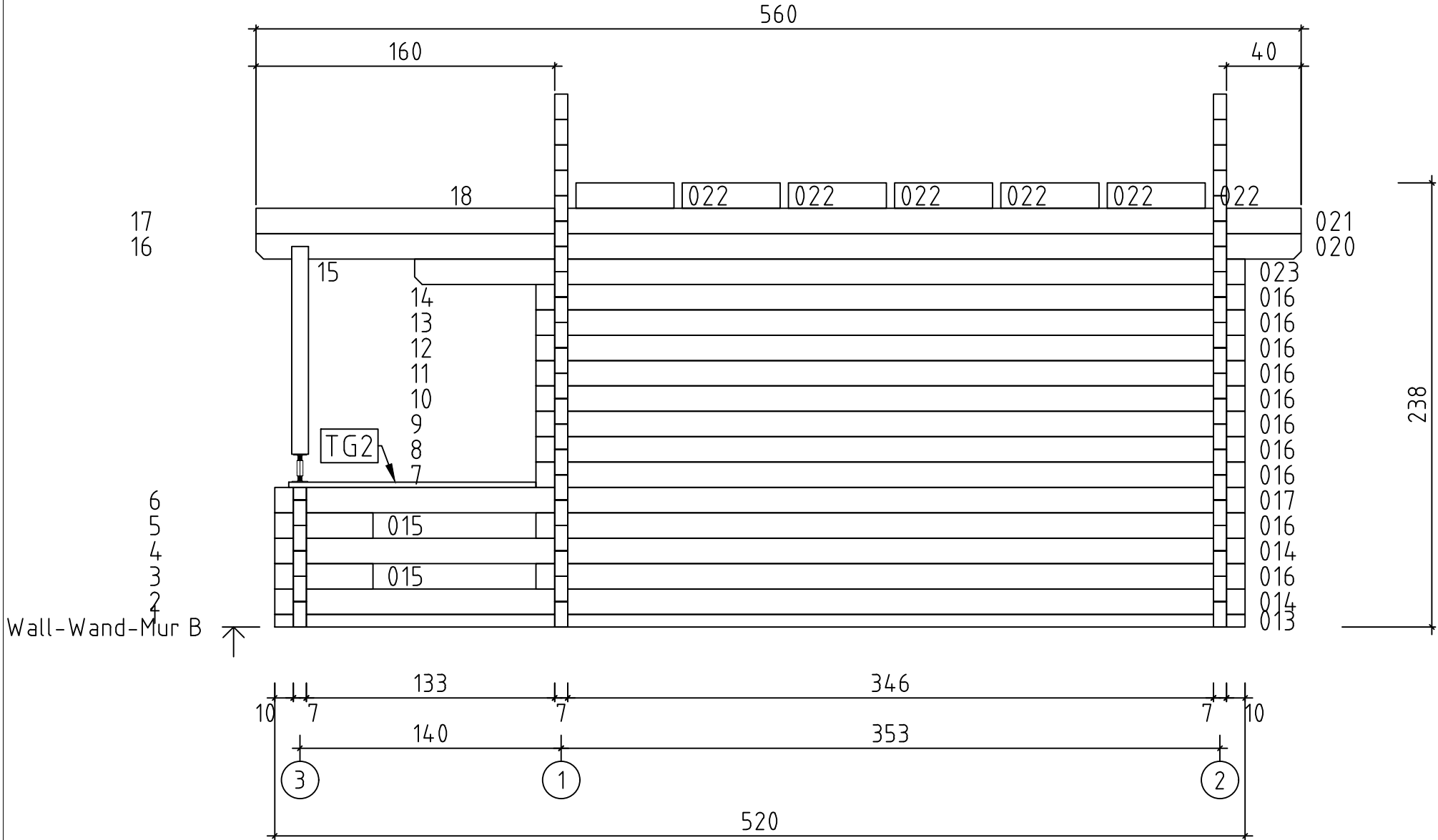

703541 - Jari

21
20

024
020



Wall-Wand-Mur C

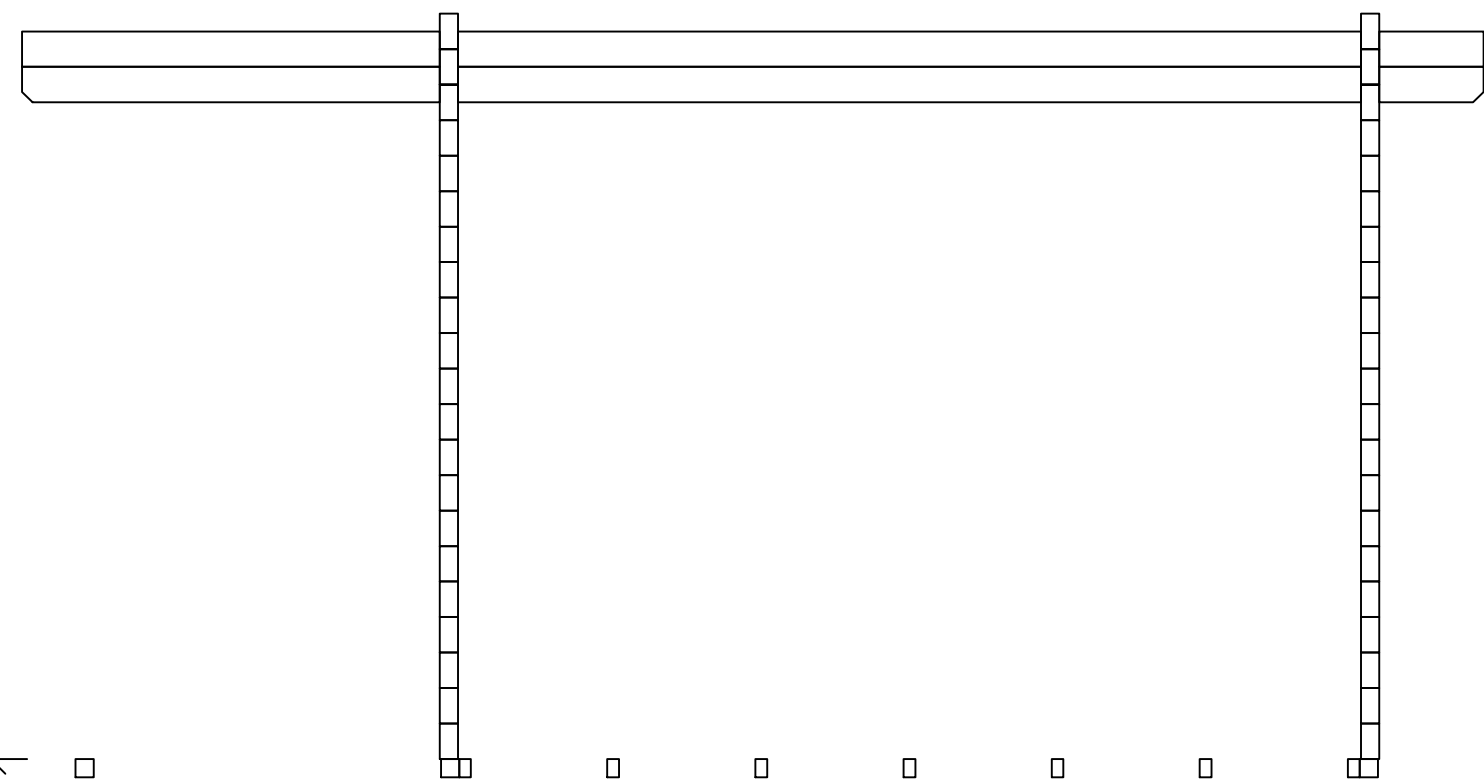

160

346

40

7

7

353







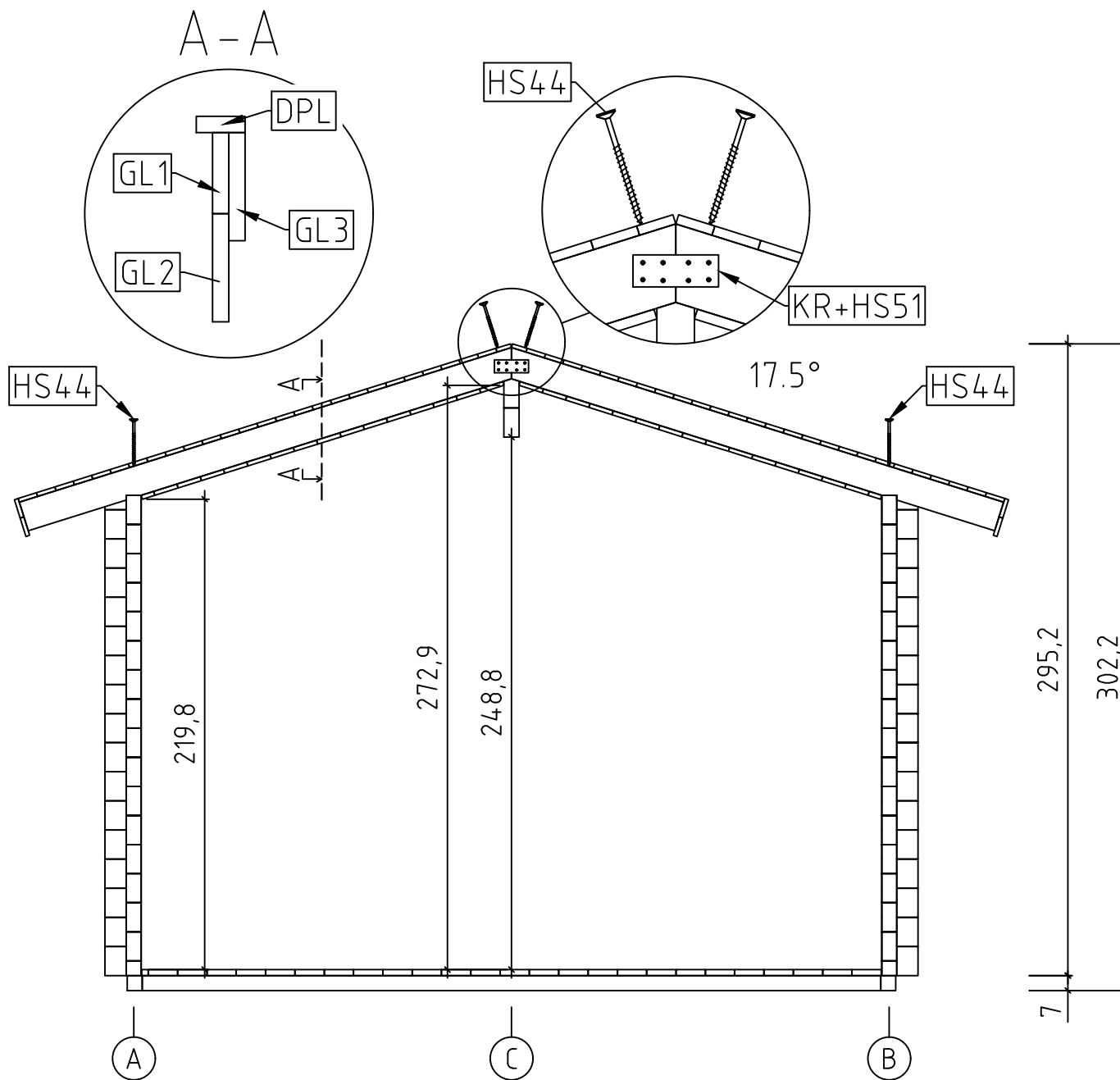

1

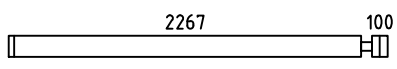

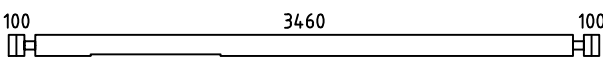
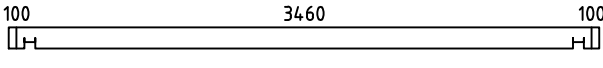
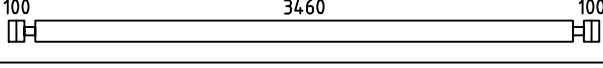

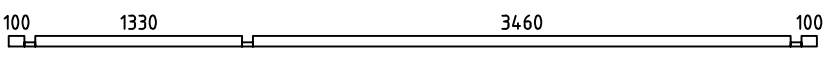
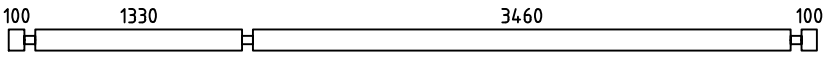

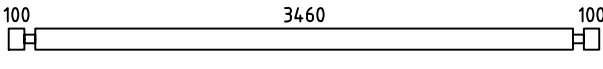
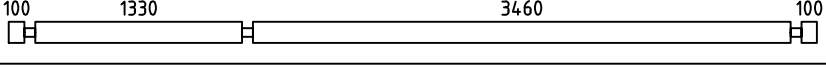
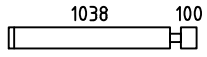
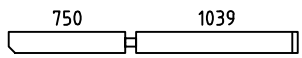
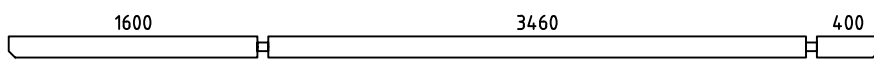
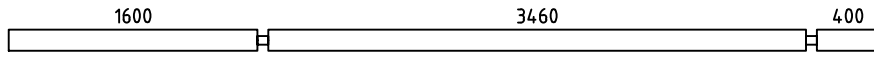
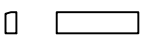
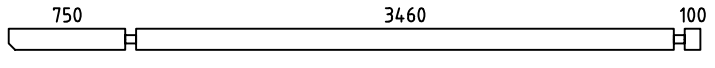
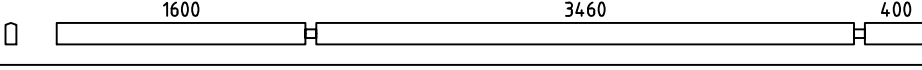

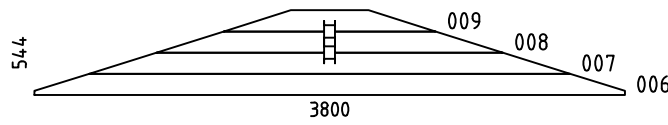
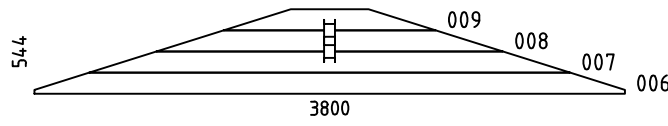





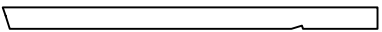
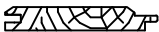



2

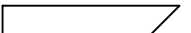
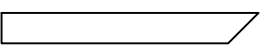

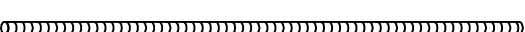
560

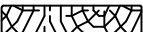

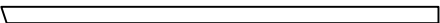
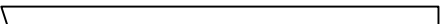

703541 - Jari

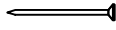
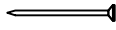

Pos	703541 - Jari Piece list - Stückliste - Liste des pieces	Q.	P (mm)	L (mm)
001		23	70x136	527
002		7	70x136	2437
003		8	70x136	527
004		1	70x136	3800
005		2	70x136	3800
010		16	70x136	3800
011		10	70x136	527
012		2	70x68	527
013		2	70x68	5200
014		4	70x136	5200
015		4	70x136	527
016		14	70x136	3800
017		2	70x136	5200
018		13	70x136	1208
019		1	70x136	1859
020		3	70x136	5600
021		2	70x136	5600
022		12	70x136	525
023		1	70x136	4450
024		1	70x136	5600
025		1	70x10	836
W1-1		1		
W2-1		1		

Pos	703541 - Jari Piece list - Stückliste - Liste des pieces	Q.	P (mm)	L (mm)
IAR1	FOUNDATION - FUNDAMENT - FONDATION 	2	70x70	4990
IAR3	FOUNDATION - FUNDAMENT - FONDATION 	3	70x70	3450
IAR4	FOUNDATION - FUNDAMENT - FONDATION 	7	45x70	3450
IAR2	FOUNDATION - FUNDAMENT - FONDATION 	7	45x70	1330
SR1	RAFTER - DACHSPARREN - CHEVRON 	24	44x140	2411
STP2 -K-1	CEILING BOARDS - DECKENBRETTER - VOLIGES SOUS PLAFOND 	34	114x19	3456
HLL-1	FLOOR BOARDS - FUSSBODENBRETTER - LAME DE PLANCHER 		137x28	98 m.
RB-1	ROOF BOARDS - DACHBRETTER - VOLIGES 	54	90x18	5600
SV2-1	TERRACE BOARDS - TERRASSENBRETTER - PLANCHER DE TERRASSE 	11	120x28	3456
SV2-2	TERRACE BOARDS - TERRASSENBRETTER - PLANCHER DE TERRASSE 	1	120x28	2742
LL-1	CEILING FILLET - DECKENLEISTE - PROFIL DE FINITION POUR SOUS PLAFOND 		15x40	21 m.
FL-1	FLOOR FILLET-FUSSBODENLEISTE - CORNIERE DE FINITION DU PLANCHER 		15x40	14 m.
TG1	TERRACE BOARDS - TERRASSENBRETTER - PLANCHER DE TERRASSE 	2	28x120	455
TG2	TERRACE BOARDS - TERRASSENBRETTER - PLANCHER DE TERRASSE 	2	28x120	1325
DPL	ROOFING FELT FILLET - DACHPAPPENLEISTE - BAGUETTE DE FIXATION DU FEUTRE BITUMEUX 	4	18x58	2460
M1	TREADED ROD M12 - GEWINDESTANGE M12 - TIGE FILETÉE M12 	4		385
M2	TREADED ROD M12 - GEWINDESTANGE M12 - TIGE FILETÉE M12 	4		2000
P	POST - PFOSTEN - POTEAU 	2	90x90	1115
TB1	EAVES BOARD - TRAUFBRETT - BANDEAU DE TOIT 	4	18x90	2200
TB2	EAVES BOARD - TRAUFBRETT - BANDEAU DE TOIT 	4	18x90	3400
TBE6-1	FIXING FILLET FOR WINDOW - FIXIRUNGSLEISTE FÜR FENSTER - PROFIL DE FIXATION DES FENETRES 	2	28x34	916
TBE6-2	FIXING FILLET FOR WINDOW - FIXIRUNGSLEISTE FÜR FENSTER - PROFIL DE FIXATION DES FENETRES 	2	28x34	1050
TBE6-1	FIXING FILLET FOR DOOR - FIXIRUNGSLEISTE FÜR TÜR - PROFIL DE FIXATION DES PORTES 	2	28x34	2000
GL1	GABLE MOULDING - GIEBELLEISTE - PLANCHE DE RIVE 	4	18x90	2460
GL2	GABLE MOULDING - GIEBELLEISTE - PLANCHE DE RIVE 	4	18x120	2432

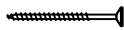
Pos	703541 - Jari Piece list - Stückliste - Liste des pieces	Q.	P (mm)	L (mm)
GL3	GABLE MOULDING - GIEBELLEISTE - PLANCHE DE RIVE 	4	18x120	2460
SP1	HIDDEN FIXING - HOLZDÜBEL - TOURILLON BOIS 	2		190
SP2	HIDDEN FIXING - HOLZDÜBEL - TOURILLON BOIS 	26		260
KL4	LENGTHENING BOLT FOR TREADED ROD - VERLÄNGERUNGSMUTTER FÜR GEWINDESTANGE - MANCHON DE RACCORDEMENT DE TIGE FILETÉE 	4		
KL1	DRIVE NUT TREADED ROD - EINSHLAGMUTTER FÜR GEWINDESTANGE - ÉCROU A FRAPPER POUR TIGE FILITÉE 	4		
KL2	NUT FOR TREADED ROD - MUTTER FÜR GEWINDESTANGE - ÉCROU POUR TIGE FILETÉE 	4		
KL3	PLAIN WASHER TREADED ROD - UNTERLEGSCHIEBE FÜR GEWINDESTANGE - RONDELLE PLATE POUR TIGE FILETÉE 	4		
HS12	SCREW FOR GABLE SEGMENT - SCHRAUBEN FÜR DECKBLATT - VIS POUR FIXATION LOSANGE DE FINITION 	4	3.5x35	
HS25	SCREW FOR FLOOR BOARDS - SCHRAUBEN FÜR FUSSBODENBRETTER - VIS D'ASSEMBLAGE DES LAMES DE PLANCHER 	189	3.5x50	
HS32	SCREW FOR EAVES BOARDS - SCHRAUBEN FÜR TRAUFBRETTER - VIS DE FIXATION POUR BANDEAU DE TOIT 	52	3.5x50	
HS84	SCREW FOR FIXING FILLET - SCHRAUBEN FÜR FIXIRUNGSLEISTE - VIS POUR PROFIL DE FIXATION 	26	3.5x50	
HS16	SCREW FOR GABLE MOULDING - SCHRAUBEN FÜR GIEBELLEISTE - VIS DE FIXATION POUR PLANCHE DE RIVE 	72	3.5x50	
HS57	SCREW FOR TERRACE REAR BOARDS - SCHRAUBEN FÜR TERRASSEN- RAND - VIS DE FIXATION POUR MAIN COURANTE DE TERRASSE 	14	4.5x80	
NFD	SCREW FOR ROOFING FELT FILLET - SCHRAUBEN FÜR DACHPAPPENLEISTE - VIS POUR BAGUETTE FIXATION FEUTRE BITUMEUX 	24	4x40	
HS34	SCREW FOR POST - SCHRAUBEN FÜR PFOSTEN - VIS DE FIXATION DES POTEAUX 	4	4x60	
HS40	SCREW FOR 1. WALL BEAM - SCHRAUBE FÜR 1. BOHLENREIHE - VIS DE FIXATION DES FONDATIONS 	8	5x120	
HS39	SCREW FOR FUNDAMENT - SCHRAUBEN ZUR BEFESTIGUNG FUNDAMENT - VIS POUR FONDATION 	38	5x120	
HS48	SCREW FOR Pos.022 - SCHRAUBEN Für Pos.022 - VIS POUR Pos.022 	24	6x180	
HS49	SCREW FOR POST HEIGHT ADJUSTMENT - SCHRAUBEN FÜR REGULIERUNGSSCHRAUBE FÜR PFOSTEN - VIS DE FIXATION DE SUPPORT RÉGLABLE DE POTEAU 	16	6x50	
HS44	SCREW FOR RIDGE BOARD - SCHRAUBEN FÜR DACHPFETTEN - VIS POUR FAITAGE 	48	8x220	
MS	SCREW FOR DOORSTEP - SCHRAUBEN FÜR TÜRSCHWELLE - VIS DE FIXATION DU SEUIL DE PORTE 	2	4.5x65	
NF3	SCREW FOR TERRACE BOARD - SCHRAUBEN FÜR TERRASSENBRETT - VIS POUR LAME DE SEUIL D'ENTREE DE TERRASSE 	164	4.2x55	
SH70	HAMMER BLOCK - SCHLAGHOLZ - CALLE DE FRAPPE 	2		
NFC	ZN NAIL FOR CEILING FILLETS - ZN NÄGEL FÜR DECKENLEISTEN - POINTE POUR CORNIERE 	42	1.4x40	
NFF	ZN NAIL FOR FLOOR FILLETS - ZN NÄGEL FÜR FUSSBODENLEISTEN - POINTE POUR PANNEAUX DE PLANCHER 	28	1.4x40	

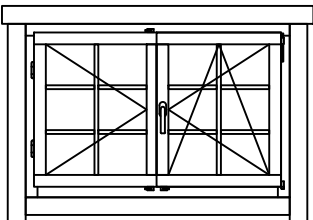
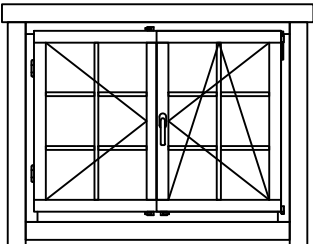
Pos	703541 - Jari Piece list - Stückliste - Liste des pieces		Q.	P (mm)	L (mm)
NF2	ZN NAIL FOR ROOF - ZN NÄGEL FÜR DACHBRETTER - POINTE POUR TOIT		684	2.1x50	
NF2	ZN NAIL FOR CEILING BOARDS - ZN NÄGEL FÜR DECKENBRETTER - CLOUS POUR VOLIGES SOUS PLAFONDS		252	2.1x50	
KR	CONNECTING PLATE - ANSCHLUSSPLATTE - PLAQUE MÉTALLIQUE DE CONNEXION		12		
HS51	SCREW FOR CONNECTING PLATE - SCHRAUBE FÜR ANSCHLUSS-PLATTE - VIS DE FIXATION DES PLAQUES DE CONNEXION		168	5x40	
ORZ	MONTAGE SET FOR DOORS AND WINDOWS - MONTAGE-SET FÜR TÜREN UND FENSTER - JEU DE MONTAGE PORTES ET FENETRES		1		
GS	GABLE SEGMENT-DECKBLATT - LOSANGE DE FINITION		2		
RFP	POST HEIGHT ADJUSTMENT - REGULIERUNGSSCHRAUBE FÜR PFOSTEN - SUPPORT RÉGLABLE DE POTEAU		2		
	WINDOW-FENSTER-FENETRE	1374x916 2+ TA.6P	1		
					
	WINDOW-FENSTER-FENETRE	1374x1050 2+ TA.6P.a	1		
					
	DOOR-TÜR-PORTE	827x2000 2+ U.26V.b	1		
	