

Canada  
Art.No. 703442

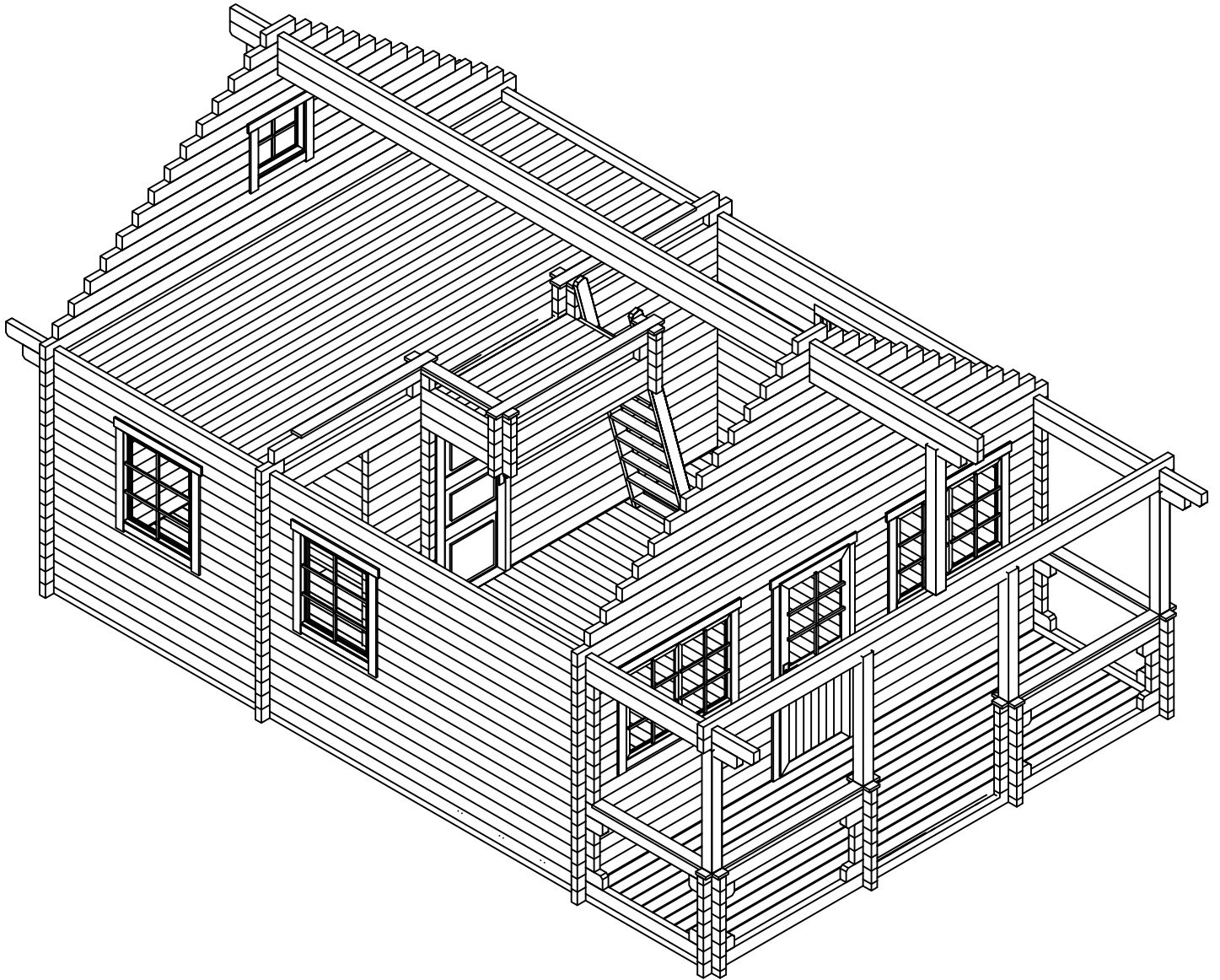

Canada, Art.No.703442  
GROUNDPLAN (Ground Floor) - GRUNDPLAN ERDGESCHLOSS - PLAN DE MASSE

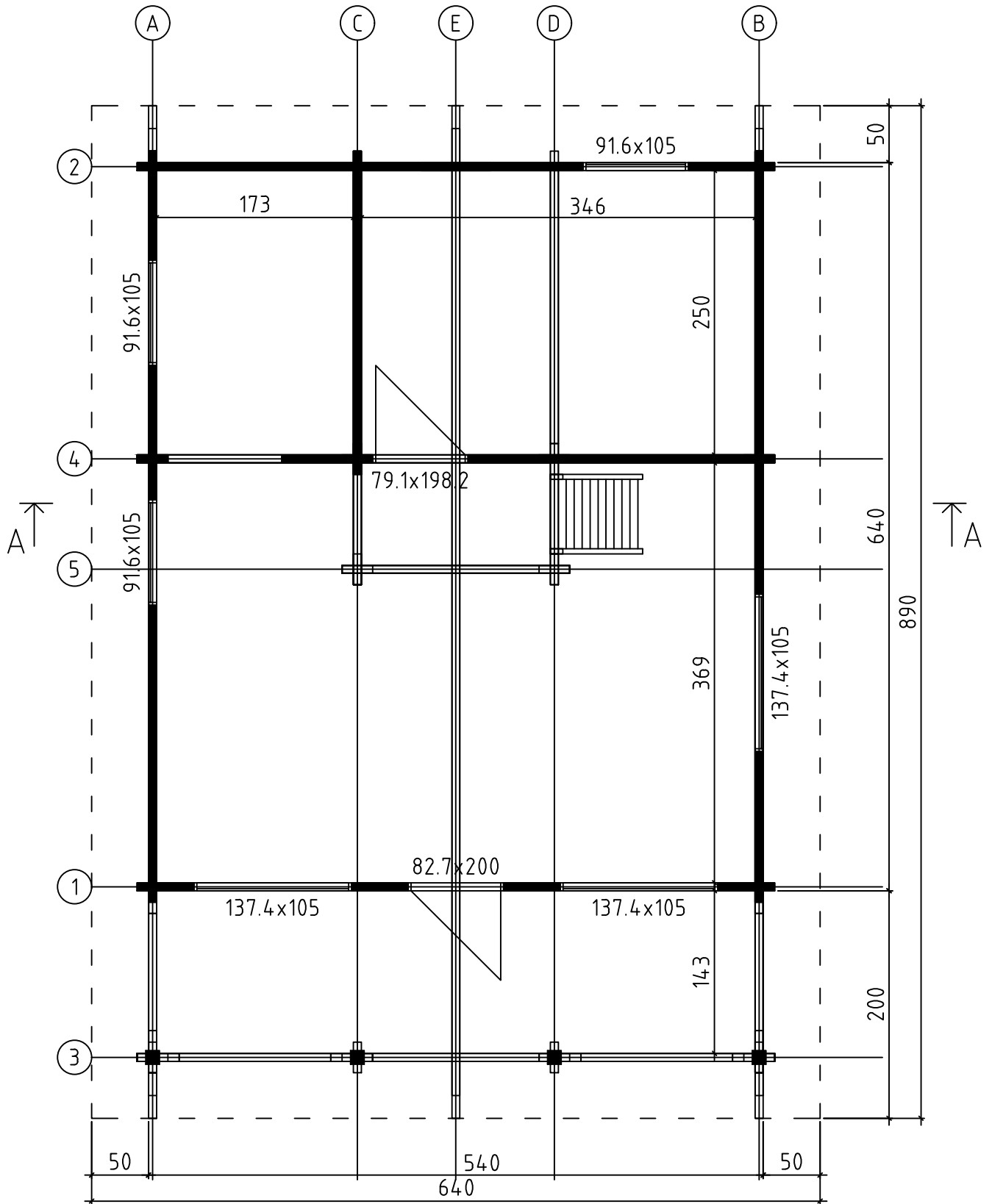

Canada, Art.No.703442  
GROUNDPLAN (First floor) - GRUNDPLAN ERSTE STOCK - PLAN DE MASSE

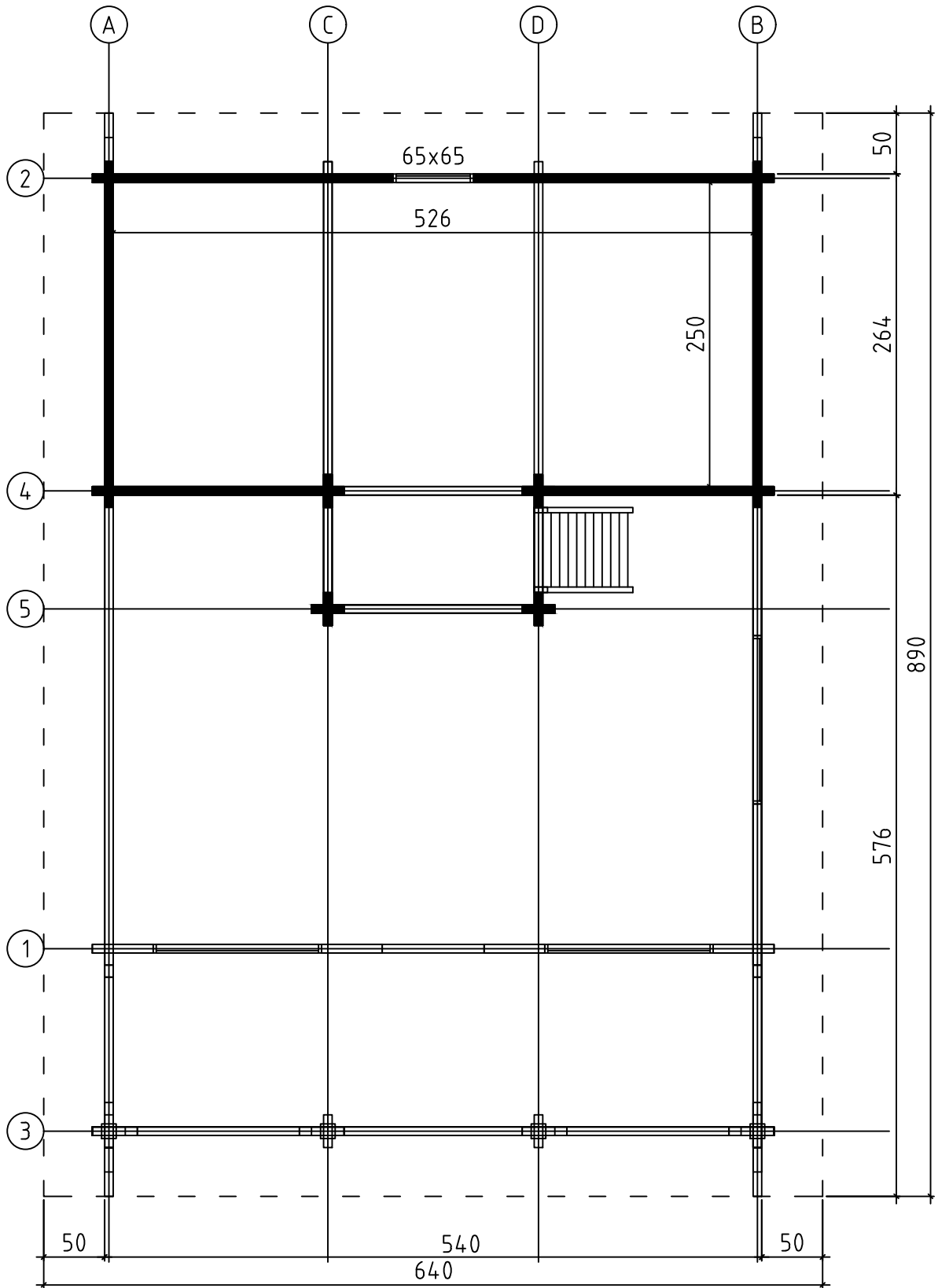



MEZZANINE FLOOR JOISTS - HALBGESCHOSS BALKEN - SOLIVES DE PLANCHER MEZZANINE

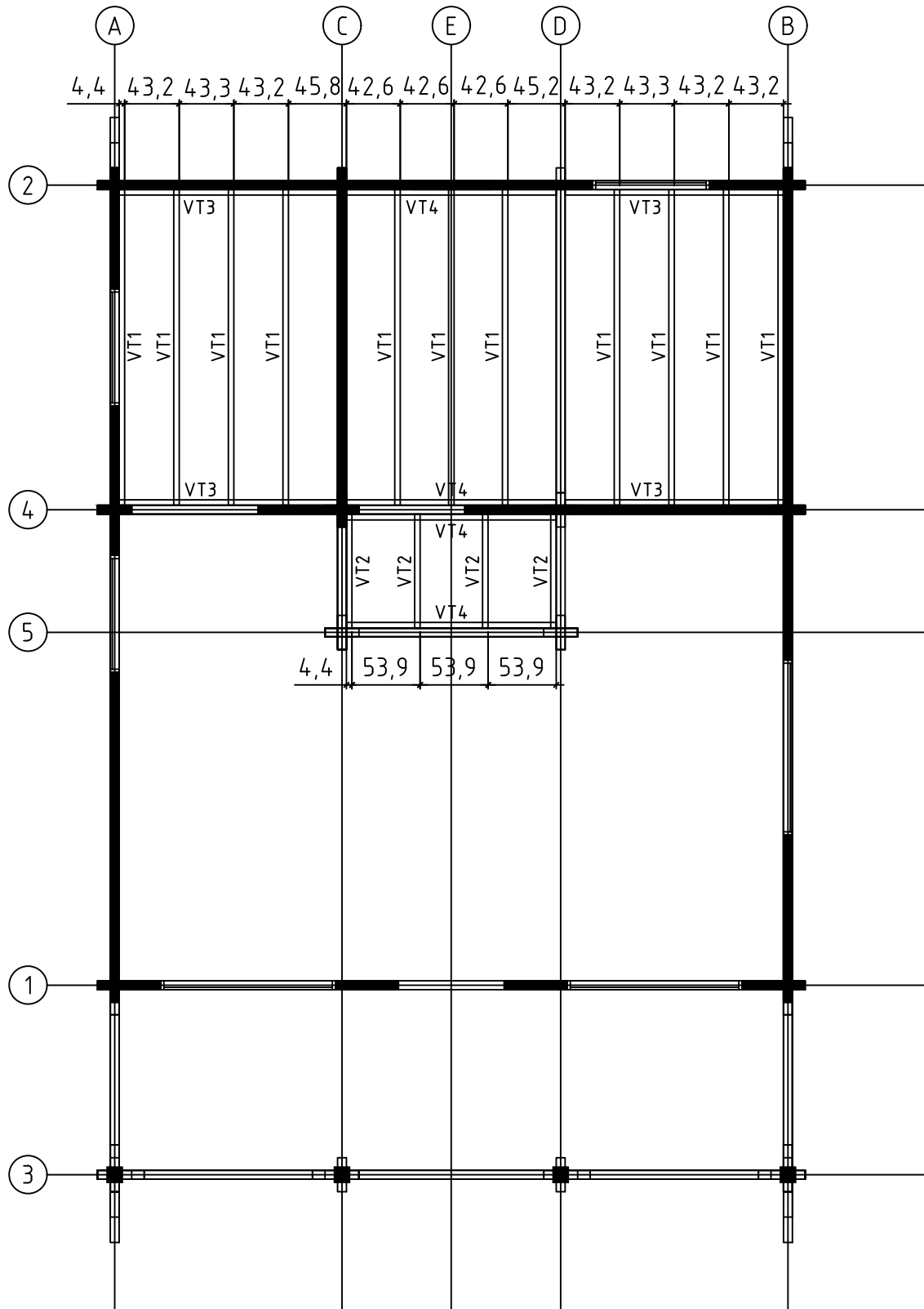



FLOOR BOARDS (Ground Floor) - FUSSBODENBRETTER ERDGESCHLOSS- PLAN POSE PLANCHER

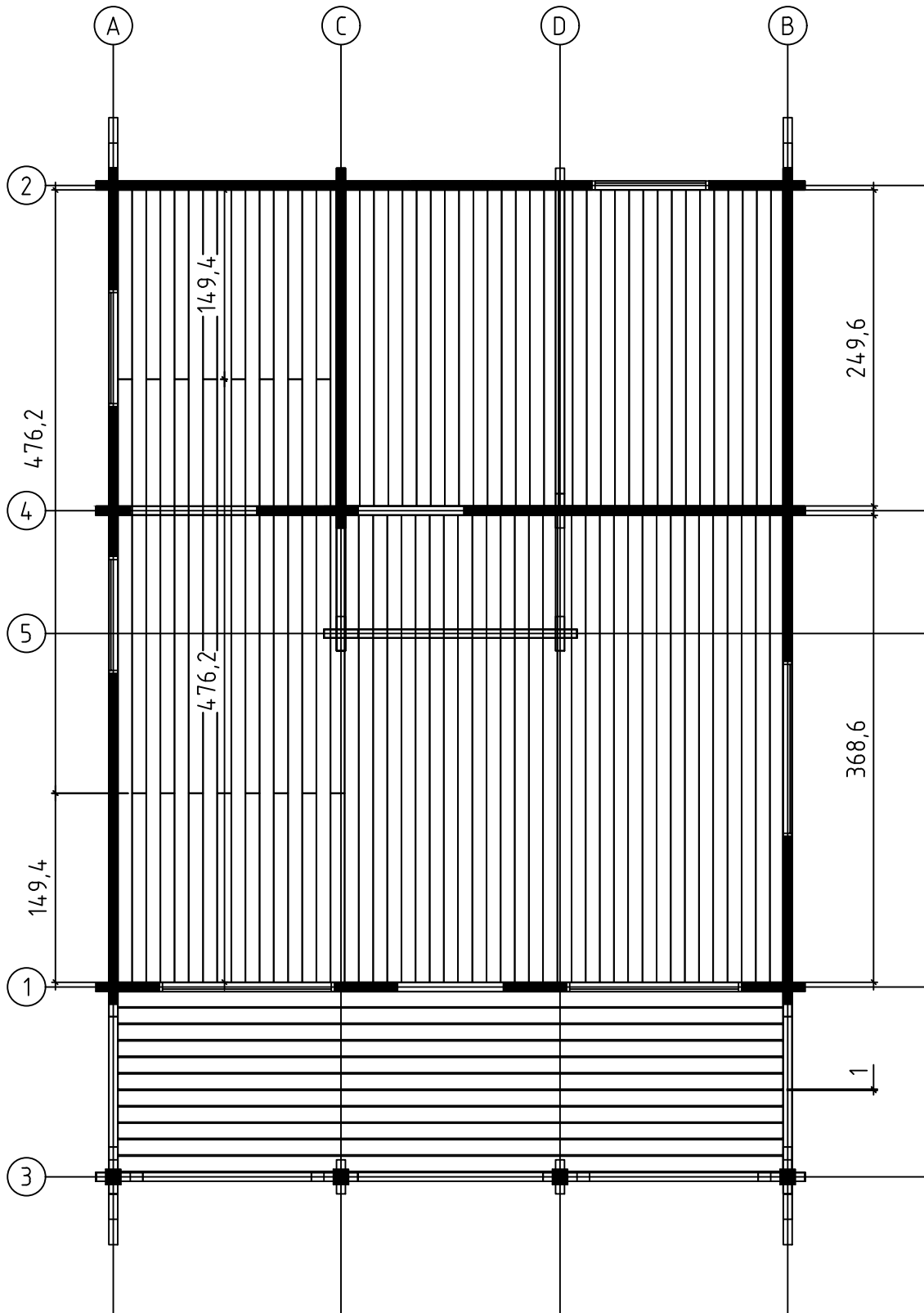

FLOOR BOARDS (First Floor) - FUSSBODENBRETTER ERSTE STOCK - PLAN POSE PLANCHER

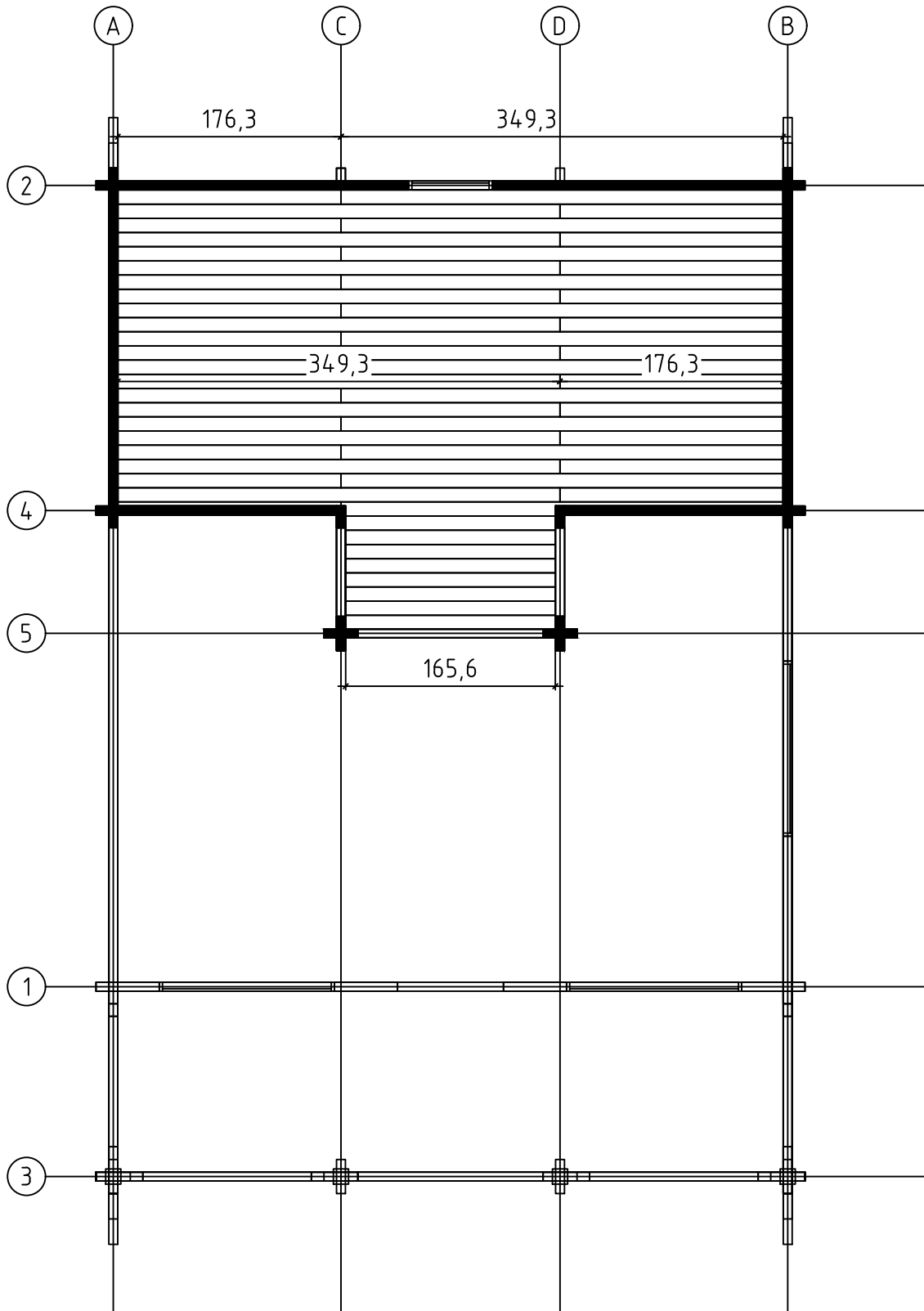



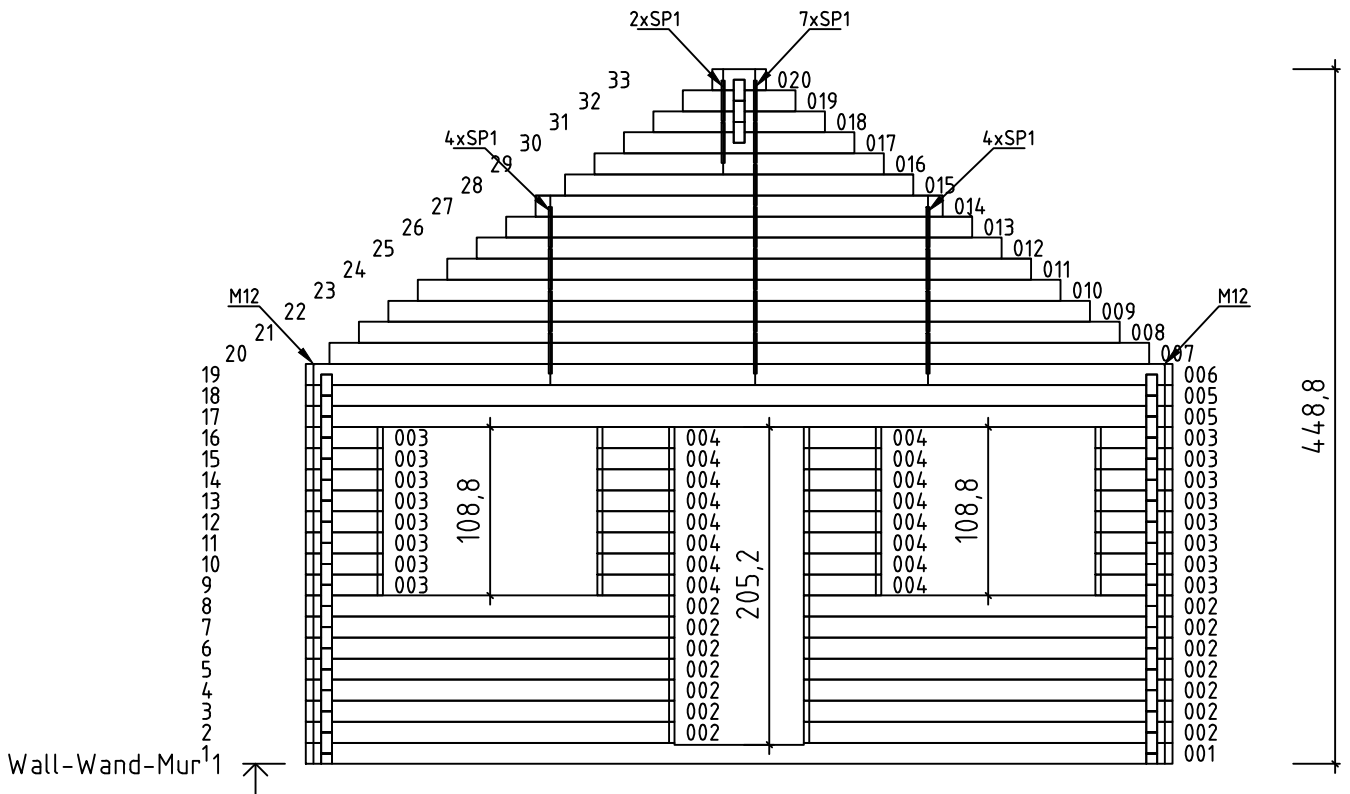

Wall-Wand-Mur 11

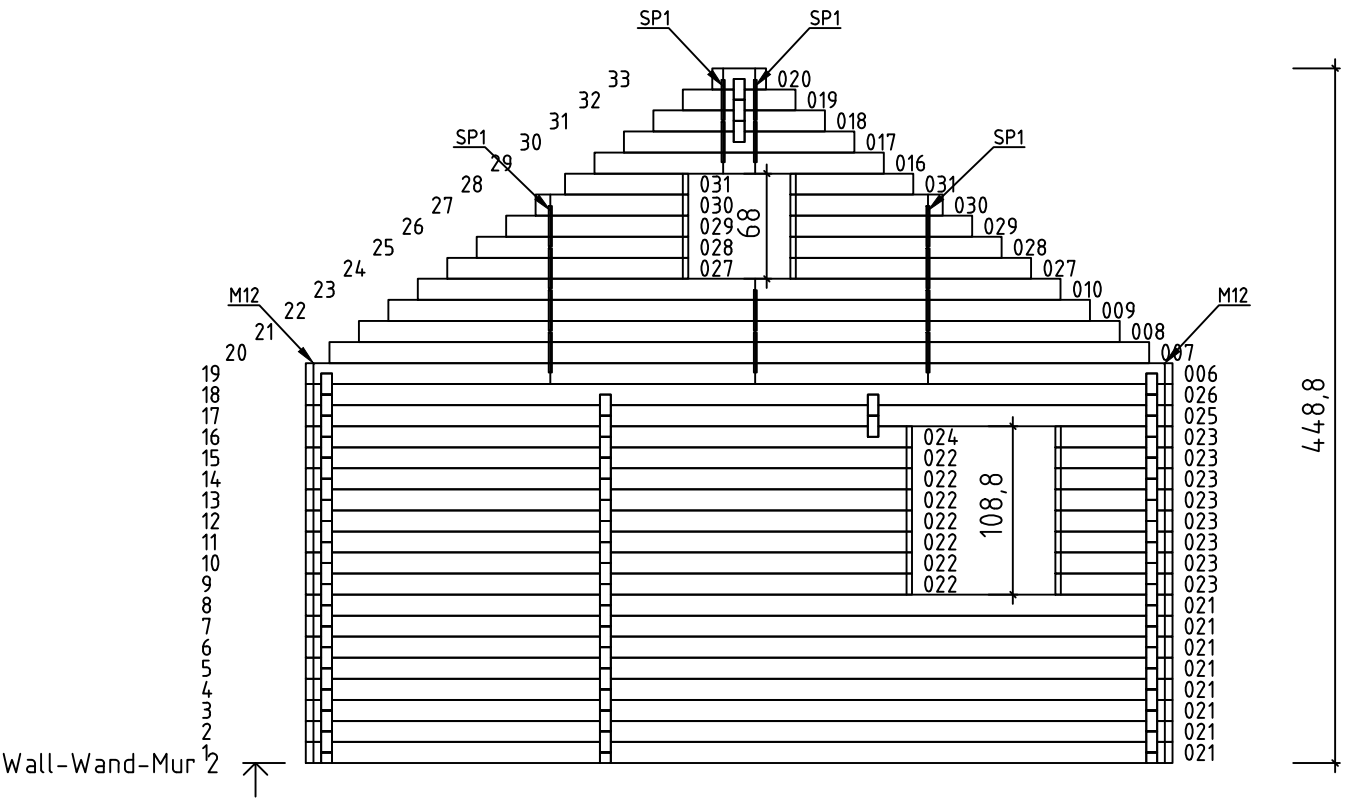
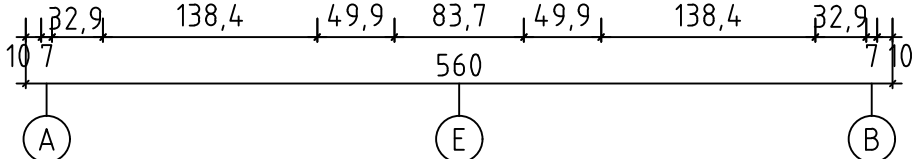

Wall-Wand-Mur 2

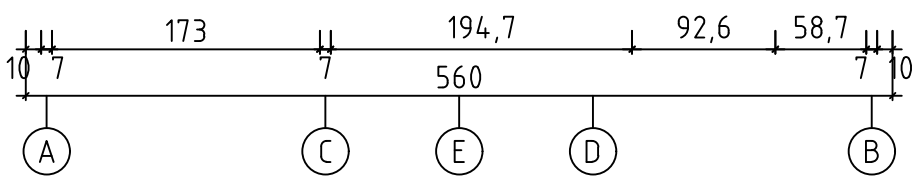

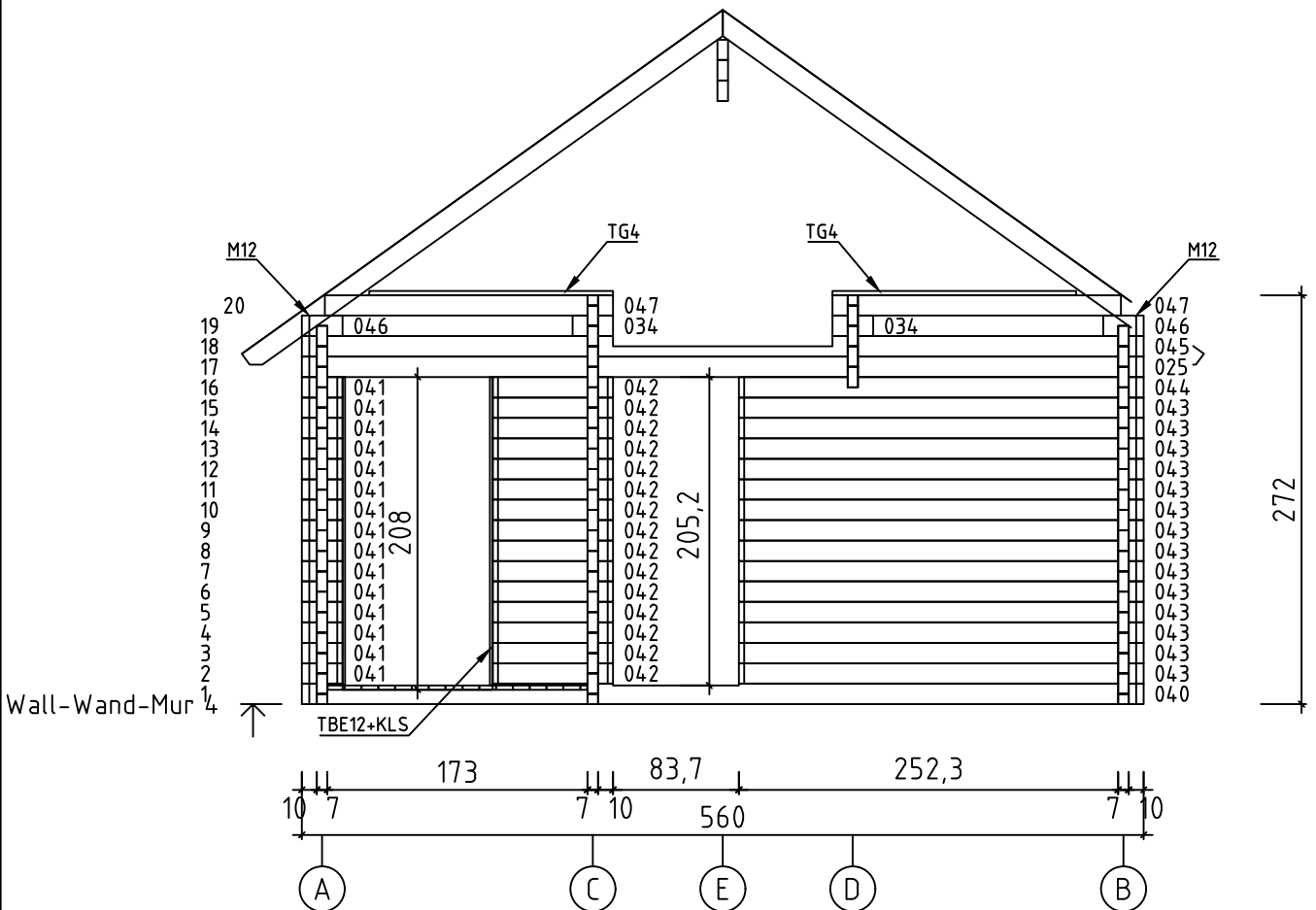
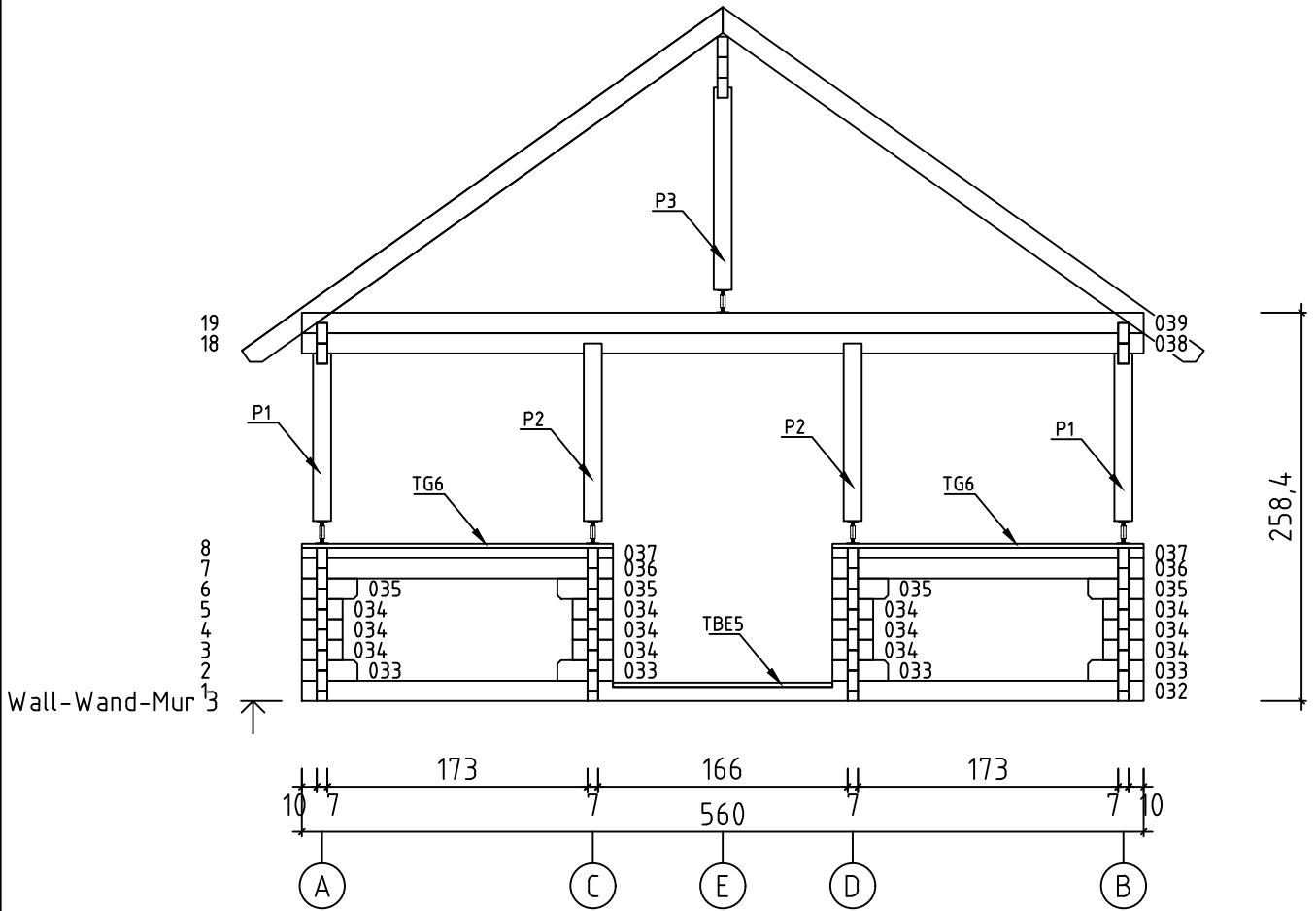

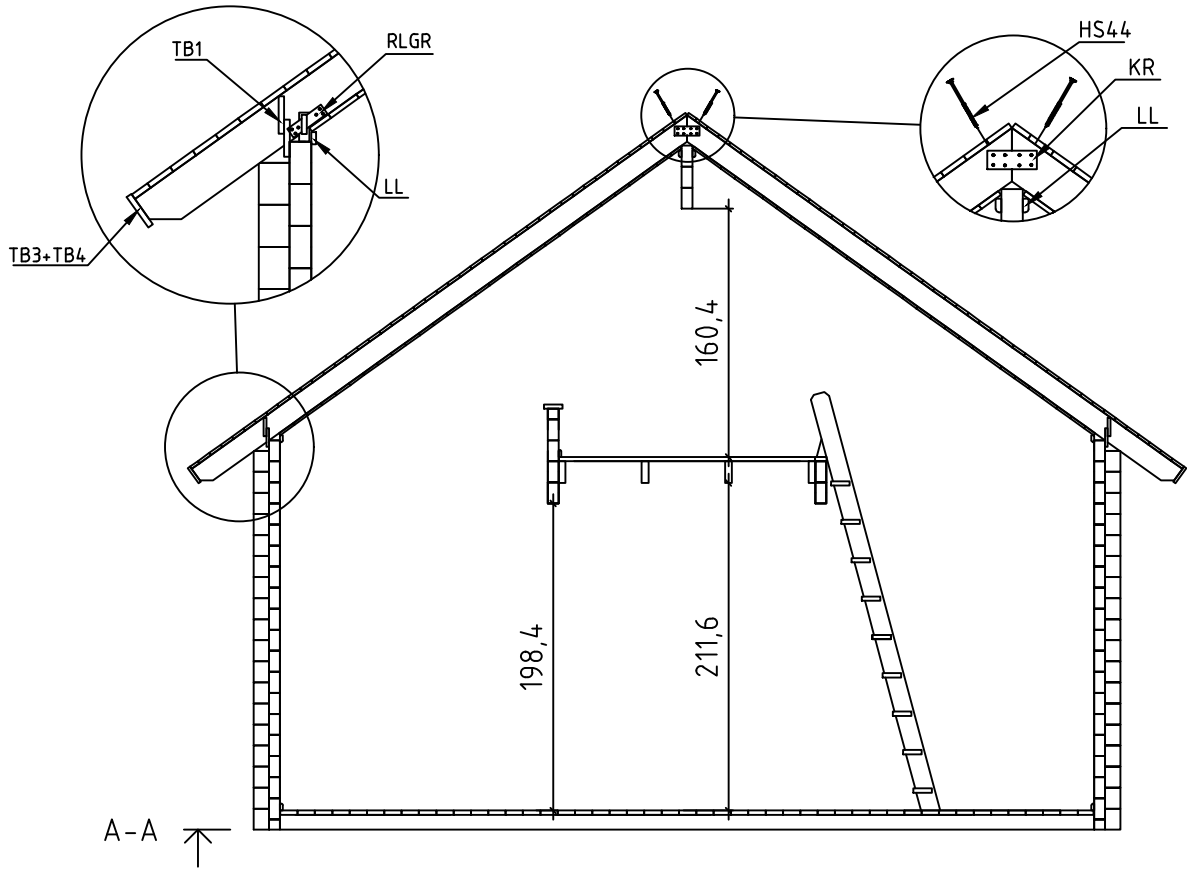
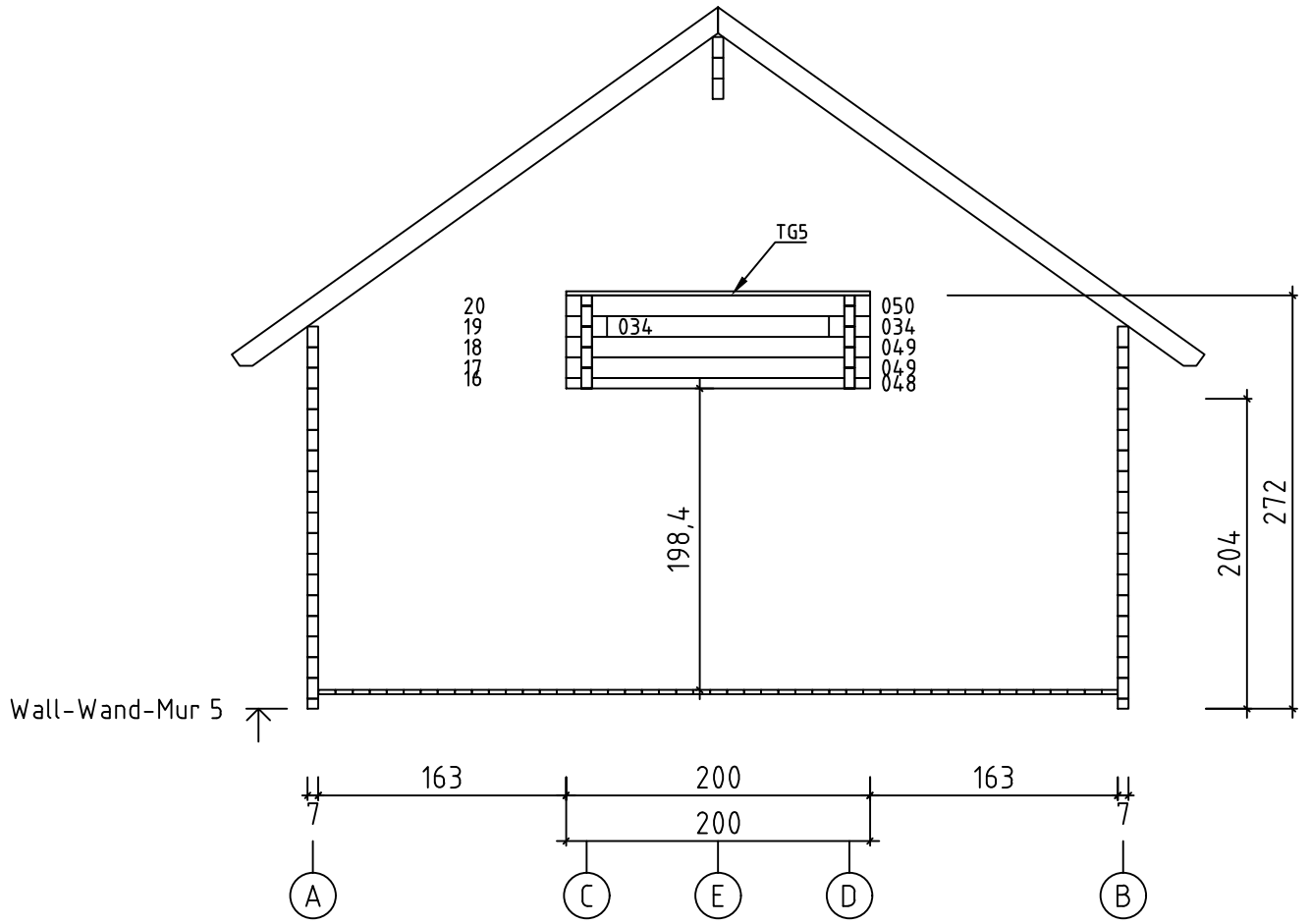

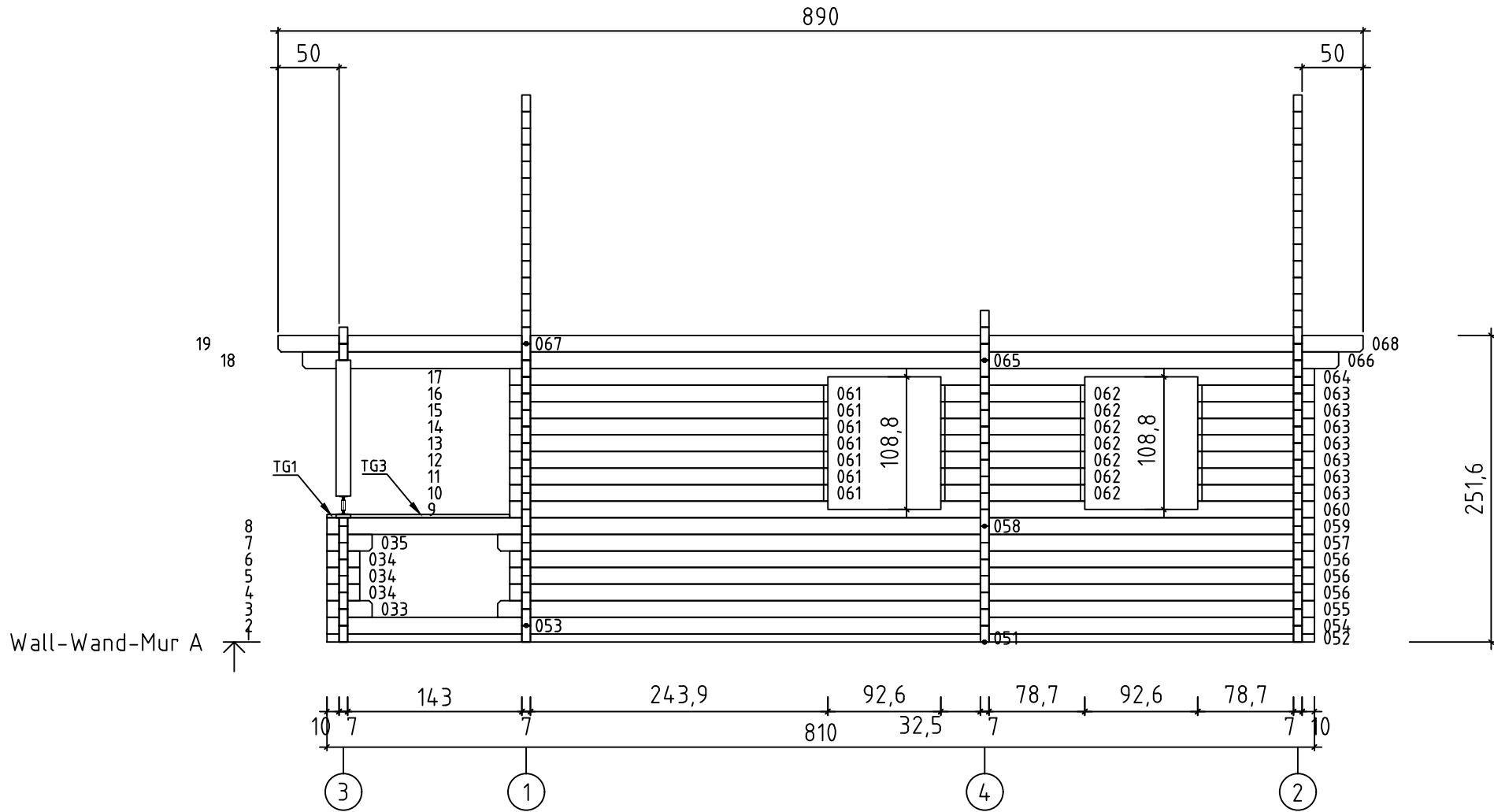



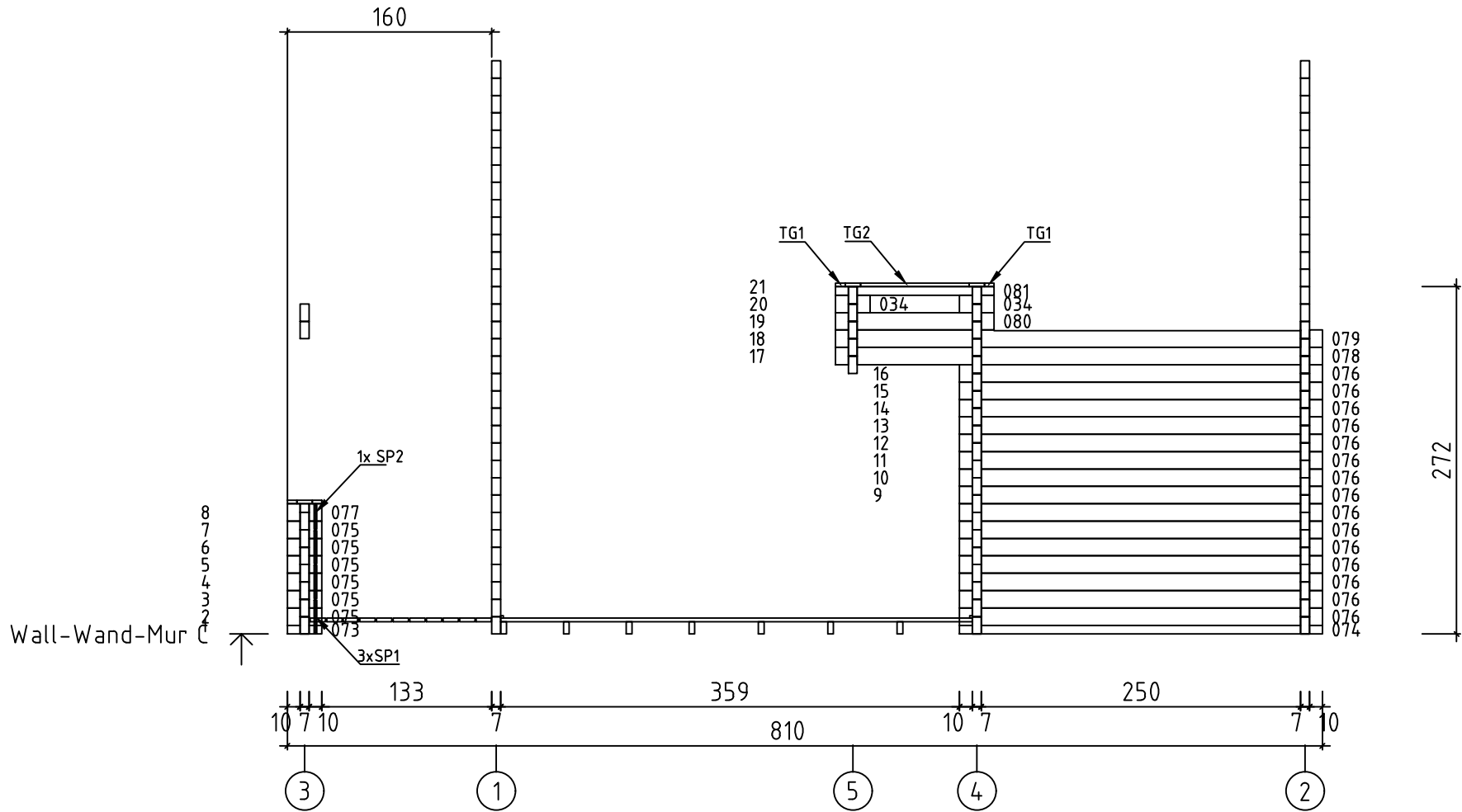





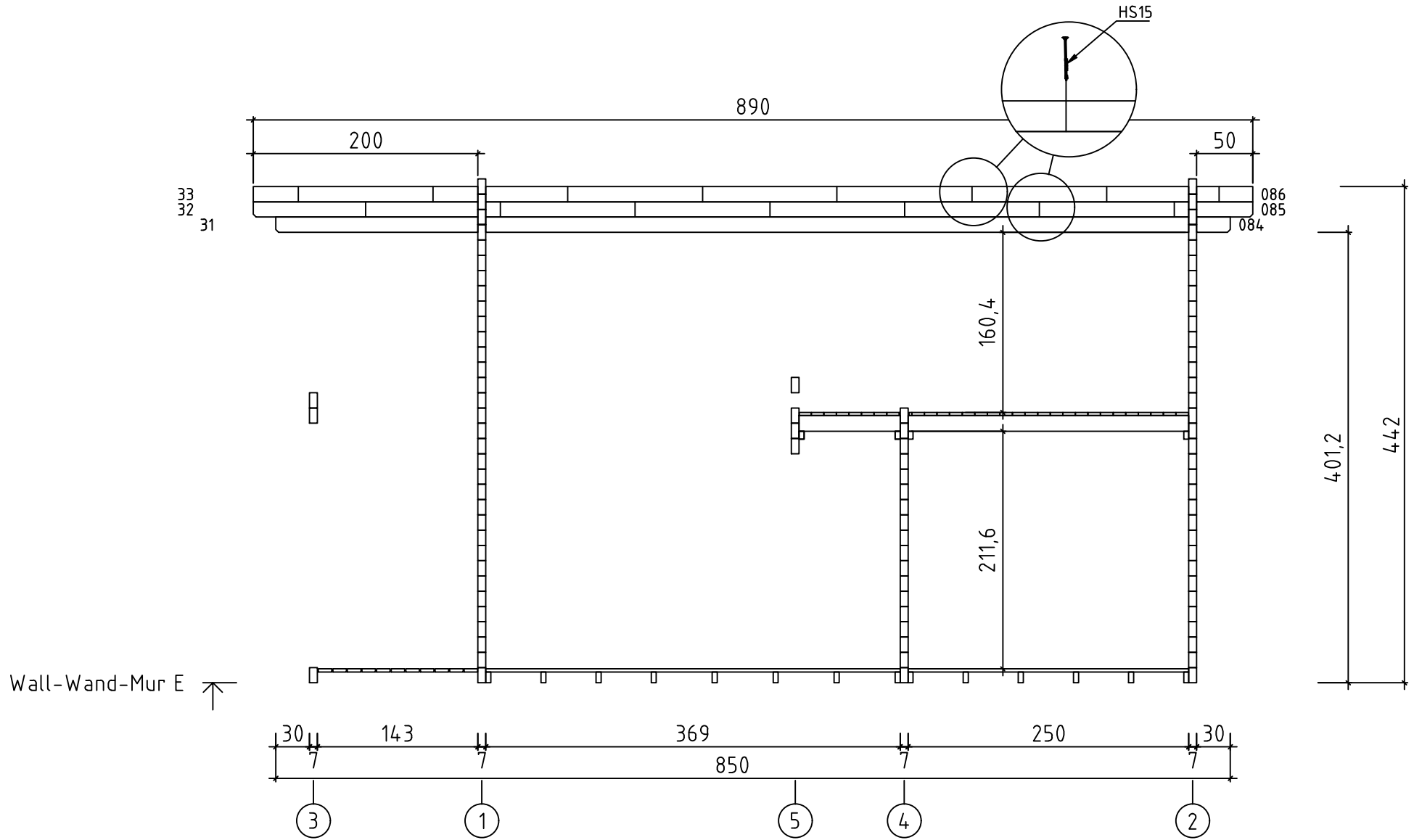

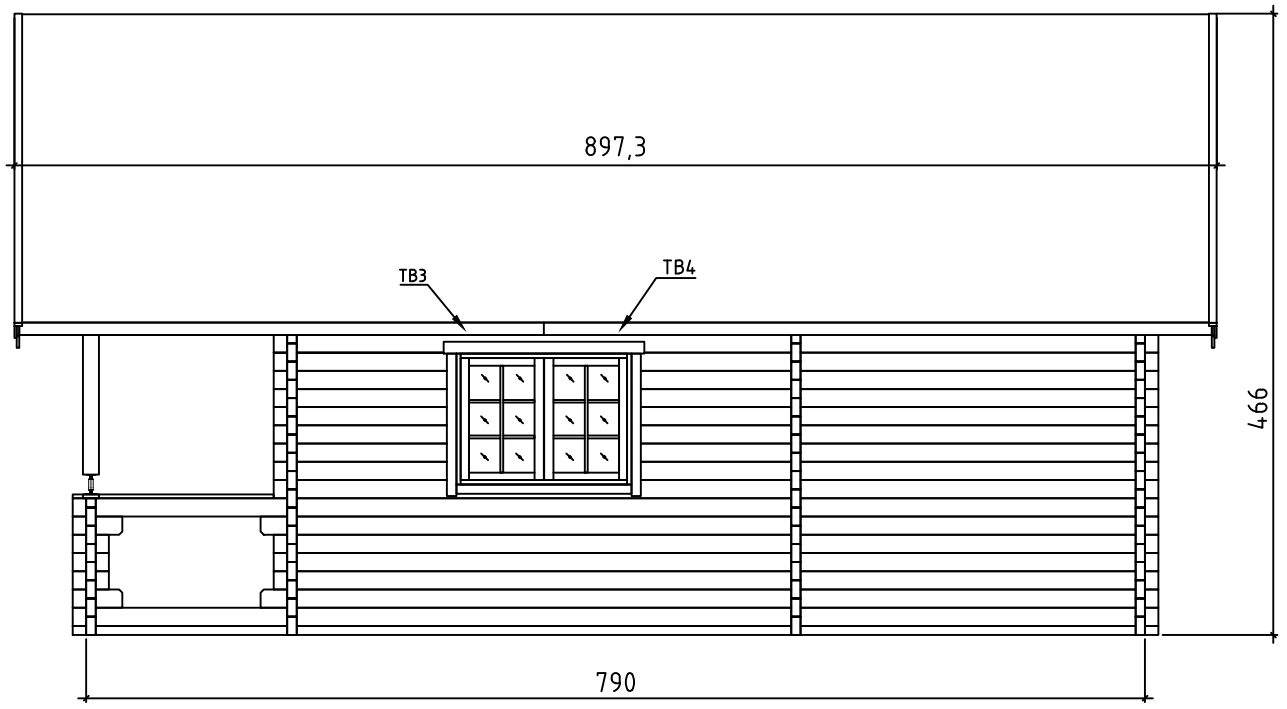
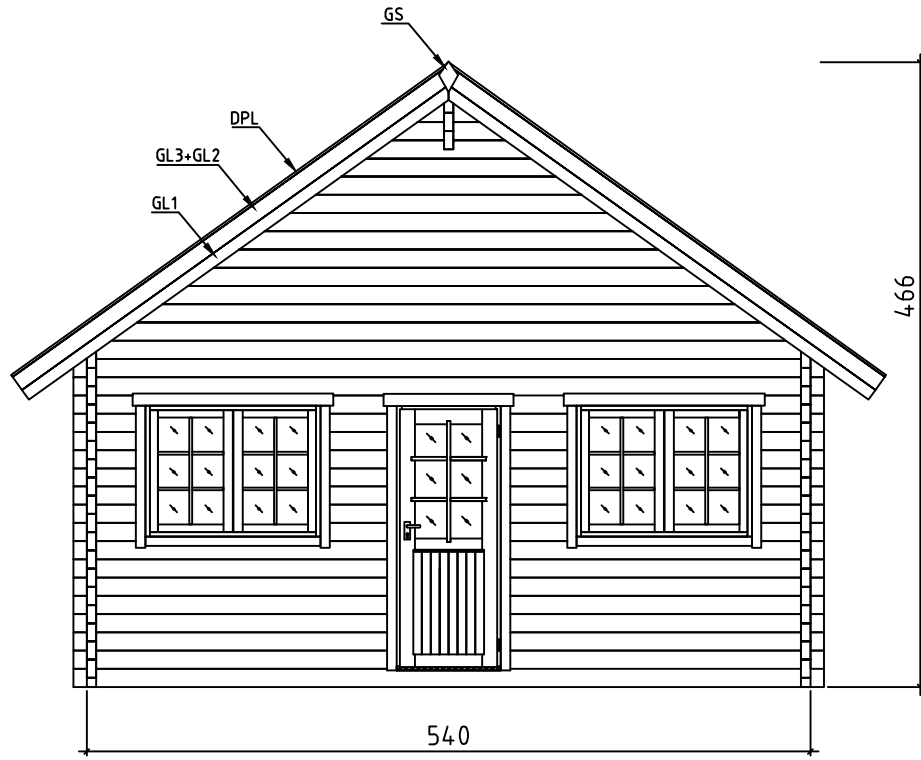

Canada, Art.No.703442

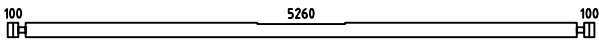
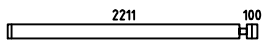

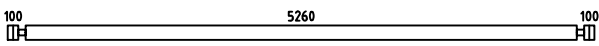
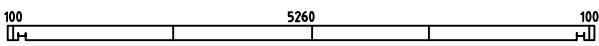
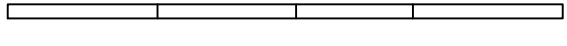
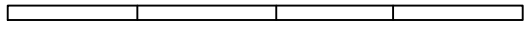
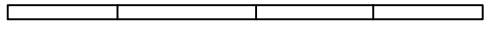
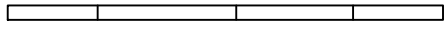
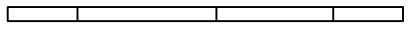
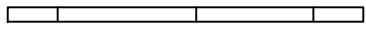
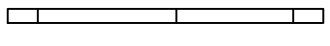
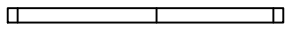
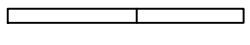
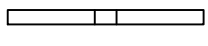
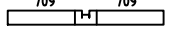
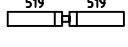

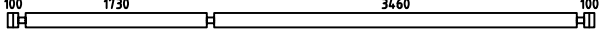
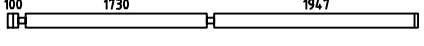





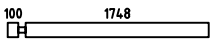
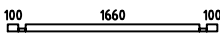
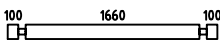
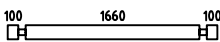
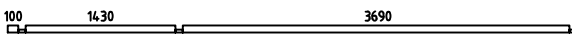
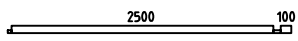
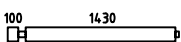
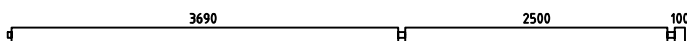
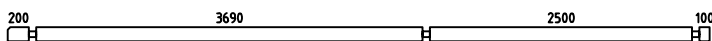

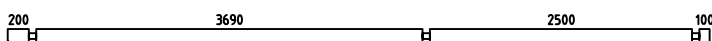
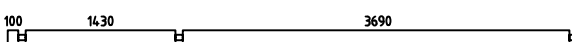
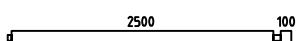
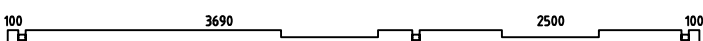
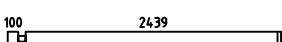
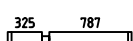
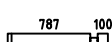

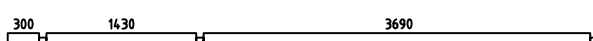
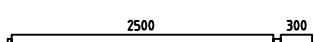
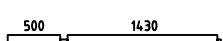
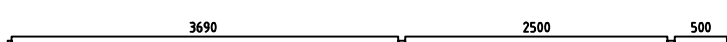



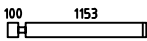
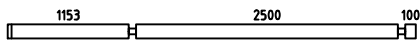
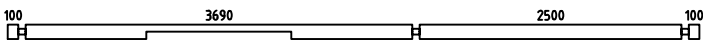

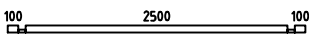

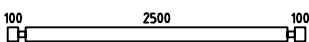

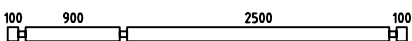

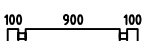
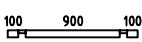
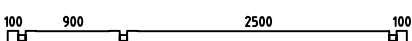

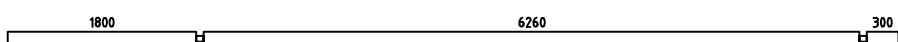
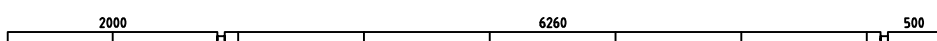
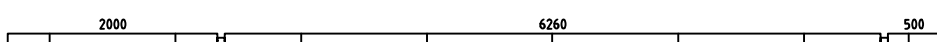







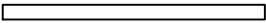

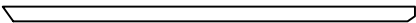

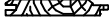





















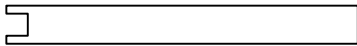
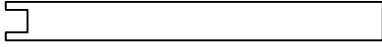
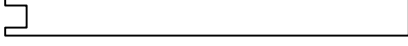





Pos	Canada, Art.No.703442 Piece list - Stückliste - Liste des pieces	Q.	P (mm)	L (mm)
001		1	70x136	5600
002		14	70x136	2381
003		16	70x136	499
004		16	70x136	499
005		2	70x136	5600
006		2	70x136	5600
007		2	70x136	5296
008		2	70x136	4915
009		2	70x136	4534
010		2	70x136	4154
011		1	70x136	3773
012		1	70x136	3392
013		1	70x136	3011
014		1	70x136	2631
015		1	70x136	2250
016		2	70x136	1869
017		2	70x136	1489
018		2	70x136	1108
019		2	70x136	727
020		2	70x136	346
021		8	70x136	5600
022		7	70x136	3917
023		8	70x136	757









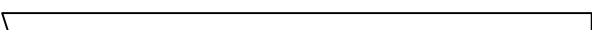
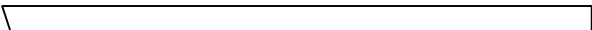
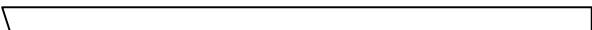



Pos	Canada, Art.No.703442 Piece list - Stückliste - Liste des pieces	Q.	P (mm)	L (mm)
024		1	70x136	3917
025		2	70x136	5600
026		1	70x136	5600
027		2	70x136	1556
028		2	70x136	1366
029		2	70x136	1176
030		2	70x136	985
031		2	70x136	795
032		1	70x136	5600
033		6	70x136	370
034		28	70x136	270
035		6	70x136	370
036		2	70x136	2070
037		2	70x68	2070
038		1	70x136	5600
039		1	70x136	5600
040		1	70x136	5600
041		15	70x136	270
042		15	70x136	800
043		14	70x136	2693
044		1	70x136	2693
045		1	70x136	5600
046		2	70x136	270

Pos	Canada, Art.No.703442 Piece list - Stückliste - Liste des pieces	Q.	P (mm)	L (mm)
047		2	70x136	1918
048		1	70x68	2000
049		2	70x136	2000
050		1	70x136	2000
051		2	70x68	5395
052		2	70x68	2705
053		2	70x136	1635
054		2	70x136	6465
055		2	70x136	6700
056		6	70x136	6600
057		2	70x136	6700
058		2	70x136	5395
059		2	70x136	2705
060		1	70x136	6600
061		7	70x136	2609
062		7	70x136	1182
063		7	70x136	957
064		1	70x136	6600
065		2	70x136	5595
066		2	70x136	2905
067		2	70x136	2035
068		2	70x136	6865
069		1	70x136	6600













Pos	Canada, Art.No.703442 Piece list - Stückliste - Liste des pieces	Q.	P (mm)	L (mm)
070		7	70x136	1323
071		7	70x136	3893
072		1	70x136	6600
073		2	70x68	270
074		1	70x68	2840
075		12	70x136	270
076		15	70x136	2840
077		2	70x136	270
078		2	70x136	3810
079		1	70x136	3810
080		1	70x136	1240
081		1	70x68	1240
082		1	70x136	3810
083		2	70x68	270
084		1	70x136	8500
085		1	70x136	8900
086		1	70x136	8900
IAR4	FOUNDATION - FUNDAMENT - FONDATION 	7	45x96	5260
IAR3	FOUNDATION - FUNDAMENT - FONDATION 	7	45x96	3460
IAR2	FOUNDATION - FUNDAMENT - FONDATION 	7	45x96	1730
IAR1	FOUNDATION - FUNDAMENT - FONDATION 	11	45x95	1430
VT3	MEZZANINE FLOOR JOISTS - HALBGESCHOSS BALKEN - SOLIVES DE PLANCHER MEZZANINE 	4	45x70	1730
VT4	MEZZANINE FLOOR JOISTS - HALBGESCHOSS BALKEN - SOLIVES DE PLANCHER MEZZANINE 	4	45x70	1660

Pos	Canada, Art.No.703442 Piece list - Stückliste - Liste des pieces	Q.	P (mm)	L (mm)
VT1	MEZZANINE FLOOR JOISTS -HALBGESCHOSS BALKEN - SOLIVES DE PLANCHER MEZZANINE 	11	44x140	2500
VT2	MEZZANINE FLOOR JOISTS -HALBGESCHOSS BALKEN - SOLIVES DE PLANCHER MEZZANINE 	4	44x140	900
SR1	RAFTER - DACHSPARREN - CHEVRON 	36	70x140	3933
STP	CEILING BOARDS - DECKENBRETTER - VOLIGES SOUS PLAFOND 	58	111x15	5008
STP	CEILING BOARDS - DECKENBRETTER - VOLIGES SOUS PLAFOND 	58	111x15	1248
PTL	FLOOR BOARDS - FUSSBODENBRETTER - LAME DE PLANCHER 	16	112x28	4762
PTL	FLOOR BOARDS - FUSSBODENBRETTER - LAME DE PLANCHER 	31	112x28	3686
PTL	FLOOR BOARDS - FUSSBODENBRETTER - LAME DE PLANCHER 	23	112x28	3493
PTL	FLOOR BOARDS - FUSSBODENBRETTER - LAME DE PLANCHER 	31	112x28	2496
PTL	FLOOR BOARDS - FUSSBODENBRETTER - LAME DE PLANCHER 	23	112x28	1763
PTL	FLOOR BOARDS - FUSSBODENBRETTER - LAME DE PLANCHER 	8	112x28	1656
PTL	FLOOR BOARDS - FUSSBODENBRETTER - LAME DE PLANCHER 	16	112x28	1494
	ROOF BOARDS - DACHBRETTER - VOLIGES 	88	90x18	4518
	ROOF BOARDS - DACHBRETTER - VOLIGES 	88	90x18	4382
SV2	TERRACE BOARDS - TERRASSENBRETTER - PLANCHER DE TERRASSE 	11	120x28	5256
LL	CEILING FILLET - DECKELEISTE - PROFIL DE FINITION POUR SOUS PLAFOND 		15x40	37.8
	FLOOR FILLET-FUSSBODENLEISTE - CORNIERE DE FINITION DU PLANCHER 		15x40	52.4
TBE5	TERRACE EDGE BOARD - TERRASSENBRETT, EINGANG - LAME DE SEUIL D'ENTREE DE TERRASSE 	1	28x70	1460
KLS	COVERING BOARD - DECKENLEISTEN - PROFILS DE FINITION 	2	18x70	2055
DPL	ROOFING FELT FILLET - DACHPAPPENLEISTE - BAGUETTE DE FIXATION DU FEUTRE BITUMEUX 	4	18x58	4000
M12	TREADED ROD M12 - GEWINDESTANGE M12 - TIGE FILETÉE M12 	6		615
M12	TREADED ROD M12 - GEWINDESTANGE M12 - TIGE FILETÉE M12 	6		2000
LPL	FIXING FILLET - FIXIRUNGSLEISTE - PROFIL DE FIXATION 	1	18x70	791

Pos	Canada, Art.No.703442 Piece list - Stückliste - Liste des pieces	Q.	P (mm)	L (mm)
LPL	FIXING FILLET - FIXIRUNGSLEISTE - PROFIL DE FIXATION 	2	18x70	2000
SWE1	DOORSTEP - SWELLE - SEUIL DE PORTE 	1	28x74	700
P1	POST - PFOSTEN - POTEAU 	2	120x120	1114
P2	POST - PFOSTEN - POTEAU 	2	120x120	1182
P3	POST - PFOSTEN - POTEAU 	1	120x120	1346
TB1	EAVES BOARD - TRAUFBRETT - BANDEAU DE TOIT 	24	18x120	533
TB2	EAVES BOARD - TRAUFBRETT - BANDEAU DE TOIT 	16	18x120	538
TB3	EAVES BOARD - TRAUFBRETT - BANDEAU DE TOIT 	2	18x120	3915
TB4	EAVES BOARD - TRAUFBRETT - BANDEAU DE TOIT 	2	18x120	4985
TBE12	FIXING FILLET - FIXIRUNGSLEISTE - PROFIL DE FIXATION 	2	28x34	1970
TBE6	FIXING FILLET FOR WINDOW - FIXIRUNGSLEISTE FÜR FENSTER - PROFIL DE FIXATION DES FENETRES 	2	28x34	650
TBE6	FIXING FILLET FOR WINDOW - FIXIRUNGSLEISTE FÜR FENSTER - PROFIL DE FIXATION DES FENETRES 	6	28x34	884
TBE6	FIXING FILLET FOR WINDOW - FIXIRUNGSLEISTE FÜR FENSTER - PROFIL DE FIXATION DES FENETRES 	6	28x34	1050
TBE6	FIXING FILLET FOR DOOR - FIXIRUNGSLEISTE FÜR TÜR - PROFIL DE FIXATION DES PORTES 	4	28x34	1970
TG1	GUARD-RAIL FOR TERRACE - TERRASSELÄNDER - MAIN COURANTE DE TERRASSE 	14	28x120	75
TG2	GUARD-RAIL FOR TERRACE - TERRASSELÄNDER - MAIN COURANTE DE TERRASSE 	1	28x120	850
TG3	GUARD-RAIL FOR TERRACE - TERRASSELÄNDER - MAIN COURANTE DE TERRASSE 	2	28x120	1305
TG4	GUARD-RAIL FOR TERRACE - TERRASSELÄNDER - MAIN COURANTE DE TERRASSE 	2	28x120	1620
TG5	GUARD-RAIL FOR TERRACE - TERRASSELÄNDER - MAIN COURANTE DE TERRASSE 	1	28x120	2000
TG6	GUARD-RAIL FOR TERRACE - TERRASSELÄNDER - MAIN COURANTE DE TERRASSE 	2	28x120	2070
GL3	GABLE MOULDING - GIEBEL- LEISTE - PLANCHE DE RIVE 	4	18x90	4000
GL1	GABLE MOULDING - GIEBEL- LEISTE - PLANCHE DE RIVE 	4	18x120	3935
GL2	GABLE MOULDING - GIEBEL- LEISTE - PLANCHE DE RIVE 	4	18x120	4000

Pos	Canada, Art.No.703442 Piece list - Stückliste - Liste des pieces	Q.	P (mm)	L (mm)
KL4	LENGTHENING BOLT FOR TREADED ROD - VERLÄNGERUNGSMUTTER FÜR GEWINDESTANGE - MANCHON DE RACCORDEMENT DE TIGE FILETÉE		6	
KL1	DRIVE NUT TREADED ROD - EINSHLAGMUTTER FÜR GEWINDESTANGE - ÉCROU A FRAPPER POUR TIGE FILITÉE		6	
KL2	NUT FOR TREADED ROD - MUTTER FÜR GEWINDESTANGE - ÉCROU POUR TIGE FILETÉE		6	
KL3	PLAIN WASHER TREADED ROD - UNTERLEGSSCHEIBE FÜR GEWINDESTANGE - RONDELLE PLATE POUR TIGE FILETÉE		6	
HS12	SCREW FOR GABLE SEGMENT - SCHRAUBEN FÜR DECKBLATT - VIS POUR FIXATION LOSANGE DE FINITION		4	3.5x35
HS83	SCREW FOR FIXING FILLET - SCHRAUBEN FÜR FIXIRUNGSLEISTE - VIS POUR PROFIL DE FIXATION		13	3.5x50
HS82	SCREW FOR CORNER FILLET- SCHRAUBEN FÜR ECKLEISTE - VIS POUR BAGUETTE DE FIXATION DU ANGLE		5	3.5x50
HS84	SCREW FOR FIXING FILLET - SCHRAUBEN FÜR FIXIRUNGSLEISTE - VIS POUR PROFIL DE FIXATION		84	3.5x50
HS16	SCREW FOR GABLE MOULDING - SCHRAUBEN FÜR GIEBELLEISTE - VIS DE FIXATION POUR PLANCHE DE RIVE		108	3.5x50
HS52	SCREW FOR FIXING STEPLADDER - SCHRAUBE FÜR BEFESTIGUNG LEITERE - LEITERE - VIS DE FIXATION POUR LES MARCHES DE L'ECHELLE		4	4.5x80
NFD	SCREW FOR ROOFING FELT FILLET - SCHRAUBEN FÜR DACHPAPPEN- LEISTE - VIS POUR BAGUETTE FIXATION FEUTRE BITUMEUX		36	4x40
HS73	SCREW FOR CONNECTING PLATE - SCHRAUBE FÜR ANSCHLUSSPLATTE - VIS DE FIXATION DES PLAQUES DE CONNEXION		144	4x40
HS32	SCREW FOR EAVES BOARDS - SCHRAUBEN FÜR TRAUFBRETT - VIS DE FIXATION POUR BANDEAU DE TOIT		200	4x40
HS86	SCREW FOR RAFTER SLIDER - SCHRAUBEN FÜR DACHSPARREN SCHIEBEREGLER - VIS DE FIXATION CURSEUR POUR CHEVRON		288	4x40
HS34	SCREW FOR POST - SCHRAUBEN FÜR PFOSTEN - VIS DE FIXATION DES POTEAUX		10	4x60
HS36	SCREW FOR STEPLADDER - SCHRAUBE FÜR LEITER - VIS D'ASSEMBLAGE DES MARCHES DE L'ECHELLE		36	4x60
HS30	SCREW FOR TERRACE REAR BOARDS - SCHRAUBEN FÜR TERRASSENRAND - VIS DE FIXATION POUR MAIN COURANTE DE TERRASSE		51	4x60
NF3	SCREW FOR TERRACE BOARD - SCHRAUBE FÜR TERRASSENBRETT - VIS POUR LAME DE SEUIL D'ENTREE DE TERRASSE		246	4x60
HS86	SCREW FOR MEZZANINE FLOOR JOISTS - SCHRAUBEN FÜR HALBGESCHOSS BALKEN - VIS DE FIXATION SOLIVES DE PLANCHER MEZZANINE		112	5x100
HS39	SCREW FOR FUNDAMENT - SCHRAUBEN ZUR BEFISTIGUNG FUNDAMENT - VIS POUR FONDATION		116	5x90
	SCREW FOR RAFTER - SCHRAUBEN ZUR BEFISTIGUNG DACHSPARREN - VIS POUR CHEVRON		36	6x180
HS49	SCREW FOR POST HEIGHT ADJUSTMENT - SCHRAUBEN FÜR REGULIERUNGSSCHRAUBE FÜR PFOSTEN - VIS DE FIXATION DE SUPPORT RÉGLABLE DE POTEAU		40	6x50
HS15	SCREW FOR FIXING ROOF BEAMS - VERBINDUNGSSCHRAUBEN FÜR DACHPFETTEN - VIS DE FIXATION DES PANNES DE TOIT		15	8x220

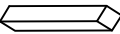

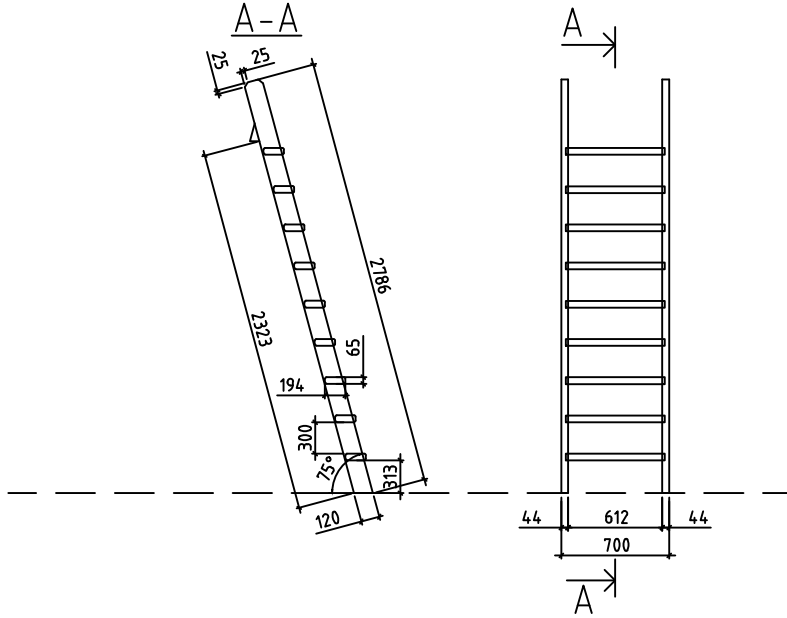
Pos	Canada, Art.No.703442 Piece list - Stückliste - Liste des pieces	Q.	P (mm)	L (mm)
MS	SCREW FOR DOORSTEP - SCHRAUBEN FÜR TÜRSCHWELLE - VIS DE FIXATION DU SEUIL DE PORTE 	4	4.5x65	
SH70	HAMMER BLOCK - SCHLAGHOLZ - CALLE DE FRAPPE 	2		
NFC	ZN NAIL FOR CEILING FILLETS - ZN NÄGEL FÜR DECKENLEISTEN - POINTE POUR CORNIERE 	76	1.4x40	
NFF	ZN NAIL FOR FLOOR FILLETS - ZN NÄGEL FÜR FUSSBODENLEISTEN - POINTE POUR PANNEAUX DE PLANCHER 	106	1.4x40	
NF2	ZN NAIL FOR ROOF - ZN NÄGEL FÜR DACHBRETTER - POINTE POUR TOIT 	1440	2x50	
NF2	ZN NAIL FOR CEILING BOARDS - ZN NÄGEL FÜR DECKENBRETTER - CLOUS POUR VOLIGES SOUS PLAFONDS 	720	2x50	
NH1	ZN NAIL FOR FLOOR - ZN NÄGEL FÜR FUSSBODENBRETTER - CLOUS POUR PLANCHER 	1010	2x50	
KR	CONNECTING PLATE - ANSCHLUSSPLATTE - PLAQUE MÉTALLIQUE DE CONNEXION 	18		
ORZ	MONTAGE SET FOR DOORS AND WINDOWS - MONTAGE-SET FÜR TÜREN UND FENSTER - JEU DE MONTAGE PORTES ET FENETRES	1		
GS	GABLE SEGMENT-DECKBLATT - LOSANGE DE FINITION 	2		
SP2	HIDDEN FIXING - HOLZDÜBEL - TOURILLON BOIS 	2		
SP1	HIDDEN FIXING - HOLZDÜBEL - TOURILLON BOIS 	37		
RLGR	SLIDER FOR RAFTER - SCHIEBEREGLER FÜR DACHSPARREN - SABOT MÉTALLIQUE POUR FIXATION CHEVRON 	36		
RFP	POST HEIGHT ADJUSTMENT - REGULIERUNGSSCHRAUBE FÜR PFOSTEN - SUPPORT RÉGLABLE DE POTEAU 	5		
LR	LADDER - LEITER - ECHELLE 	1		

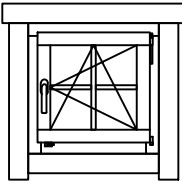
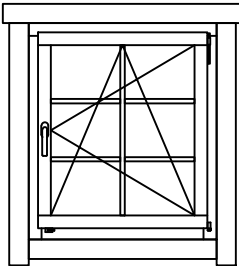
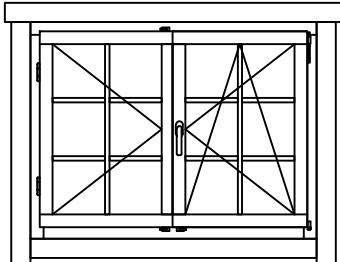
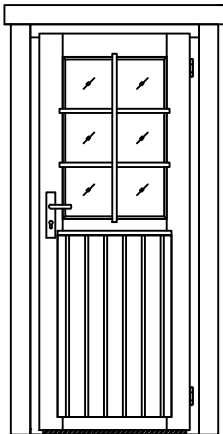
Pos	Canada, Art.No.703442 Piece list - Stückliste - Liste des pieces	Q.	P (mm)	L (mm)
2+ A.4P	<p style="text-align: center;">WINDOW-FENSTER-FENETRE 650x650</p> 	1		
2+ A.6P.a	<p style="text-align: center;">WINDOW-FENSTER-FENETRE 916x1050</p> 	3		
2+ TA.6P.a	<p style="text-align: center;">WINDOW-FENSTER-FENETRE 1374x1050</p> 	3		
2+ U.26P.b	<p style="text-align: center;">DOOR-TÜR-PORTE 827x2000</p> 	1		



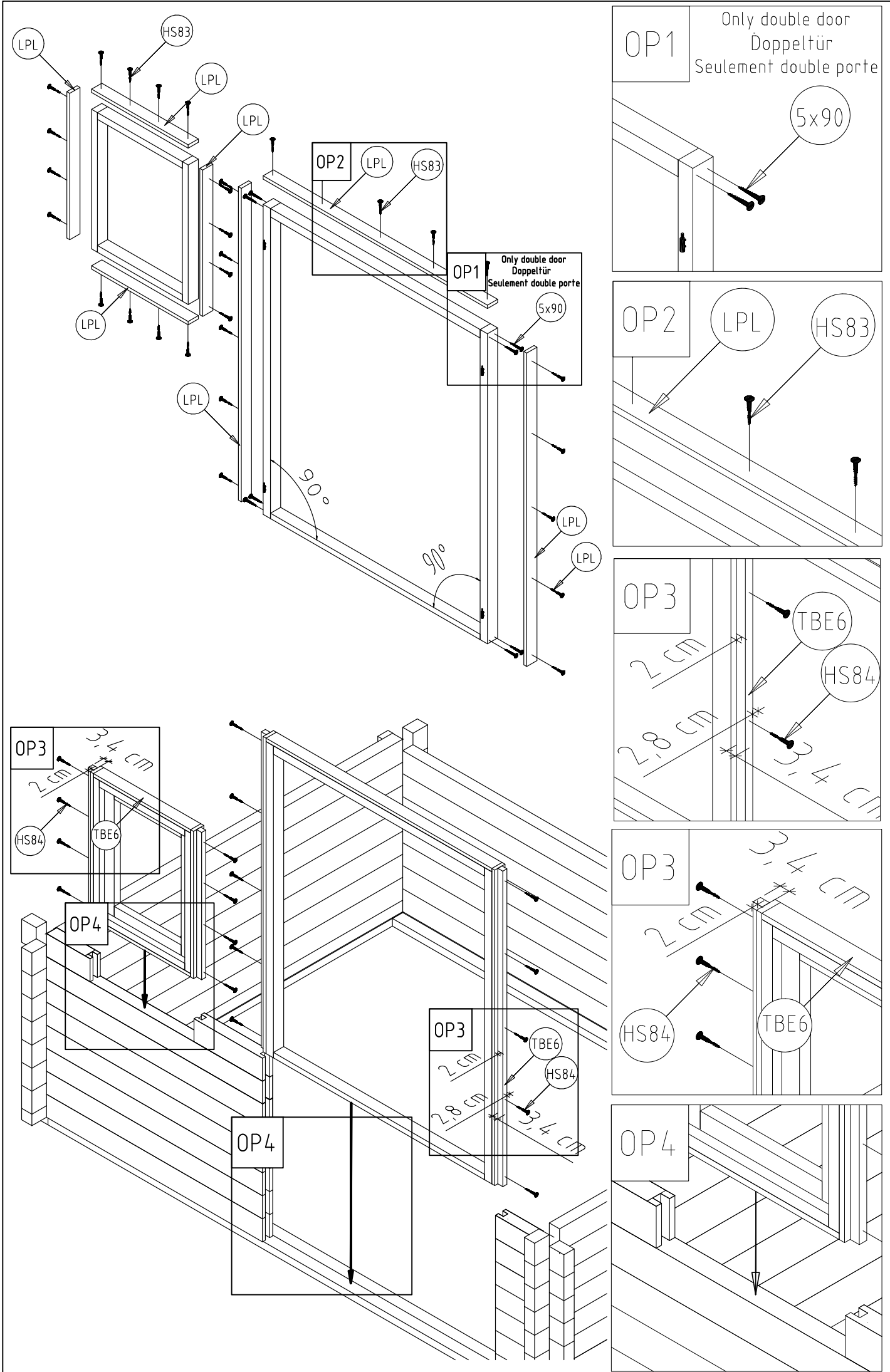

OP1 Only double door  
Doppeltür  
Seulement double porte

