

VALGA  
Art.No. 703341

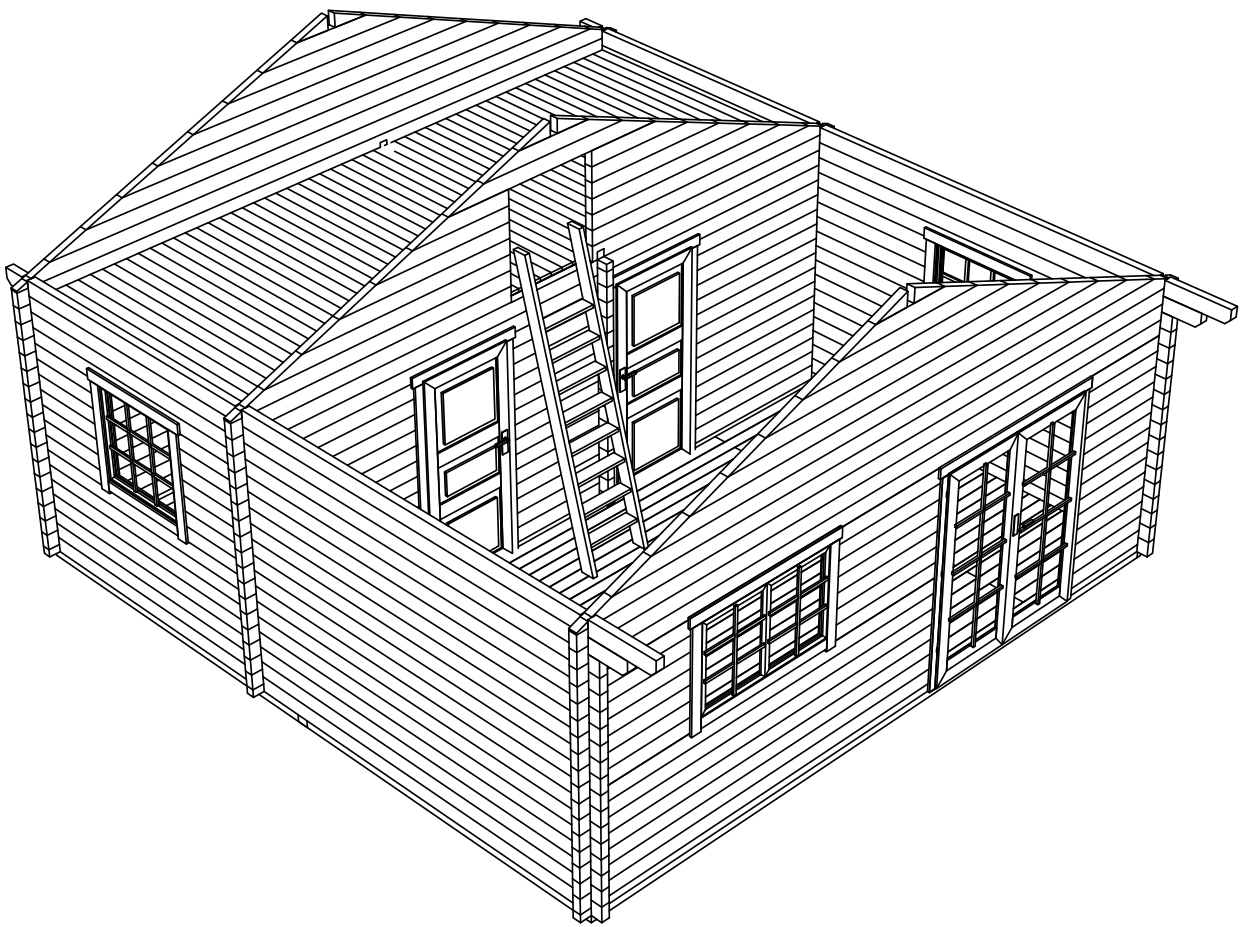

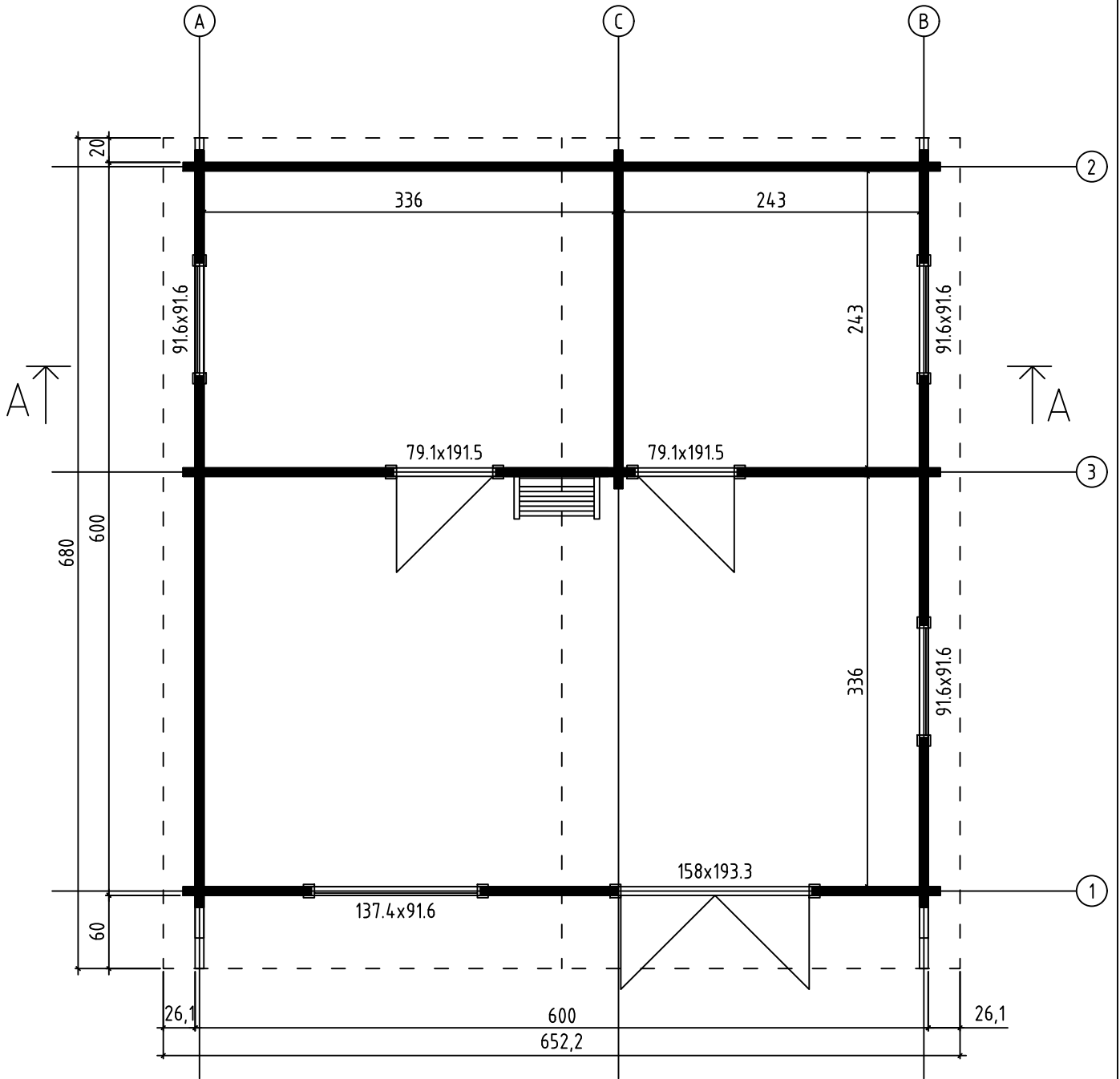

VALGA, Art.No.703341  
GROUNDPLAN 1<sup>st</sup> FLOOR - GRUNDPLAN ERSTE STOCK - PLAN DE 1<sup>ÈRE</sup> ETAGE

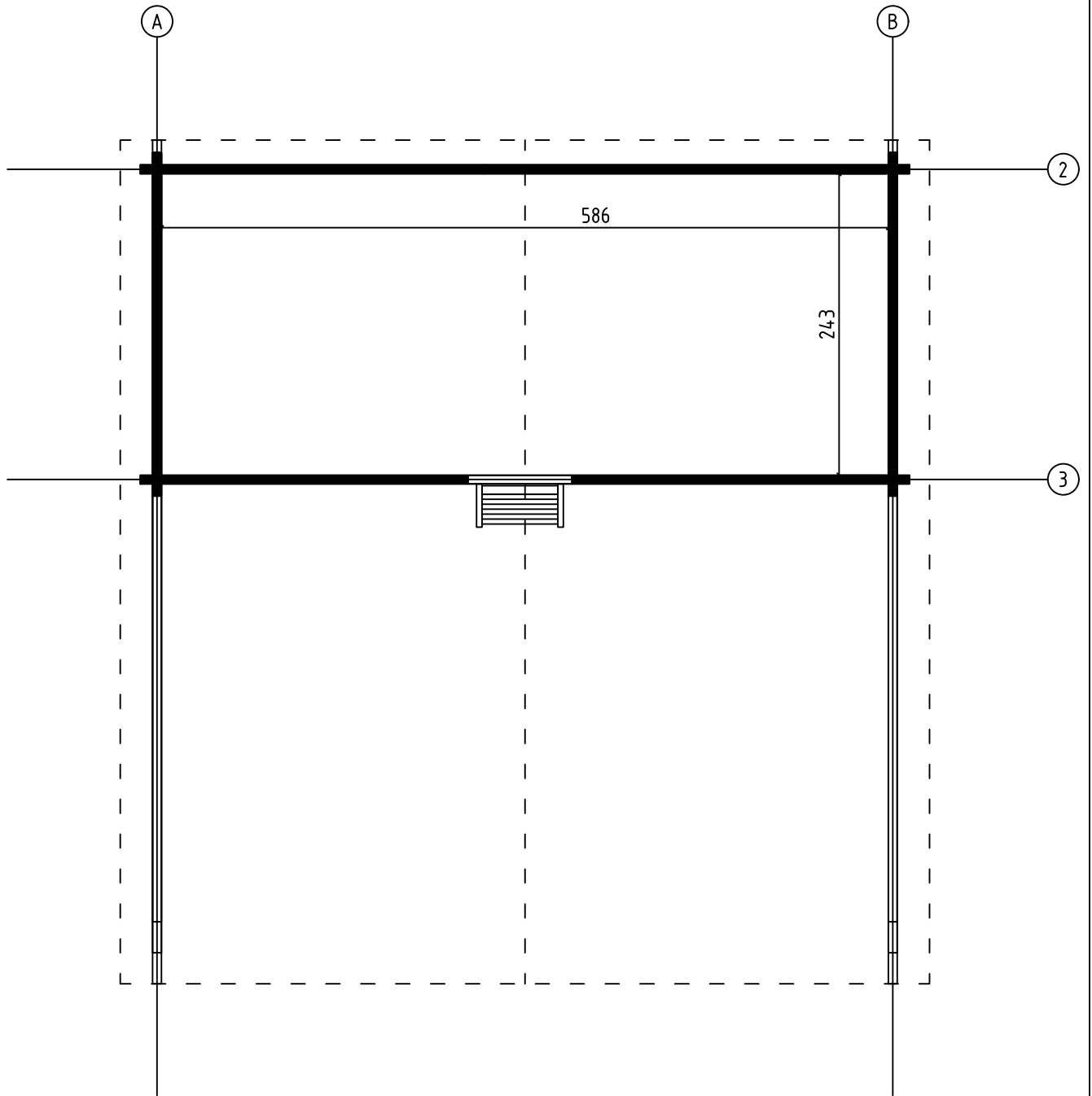

VALGA, Art.No.703341  
FOUNDATION - FUNDAMENT - FONDATION

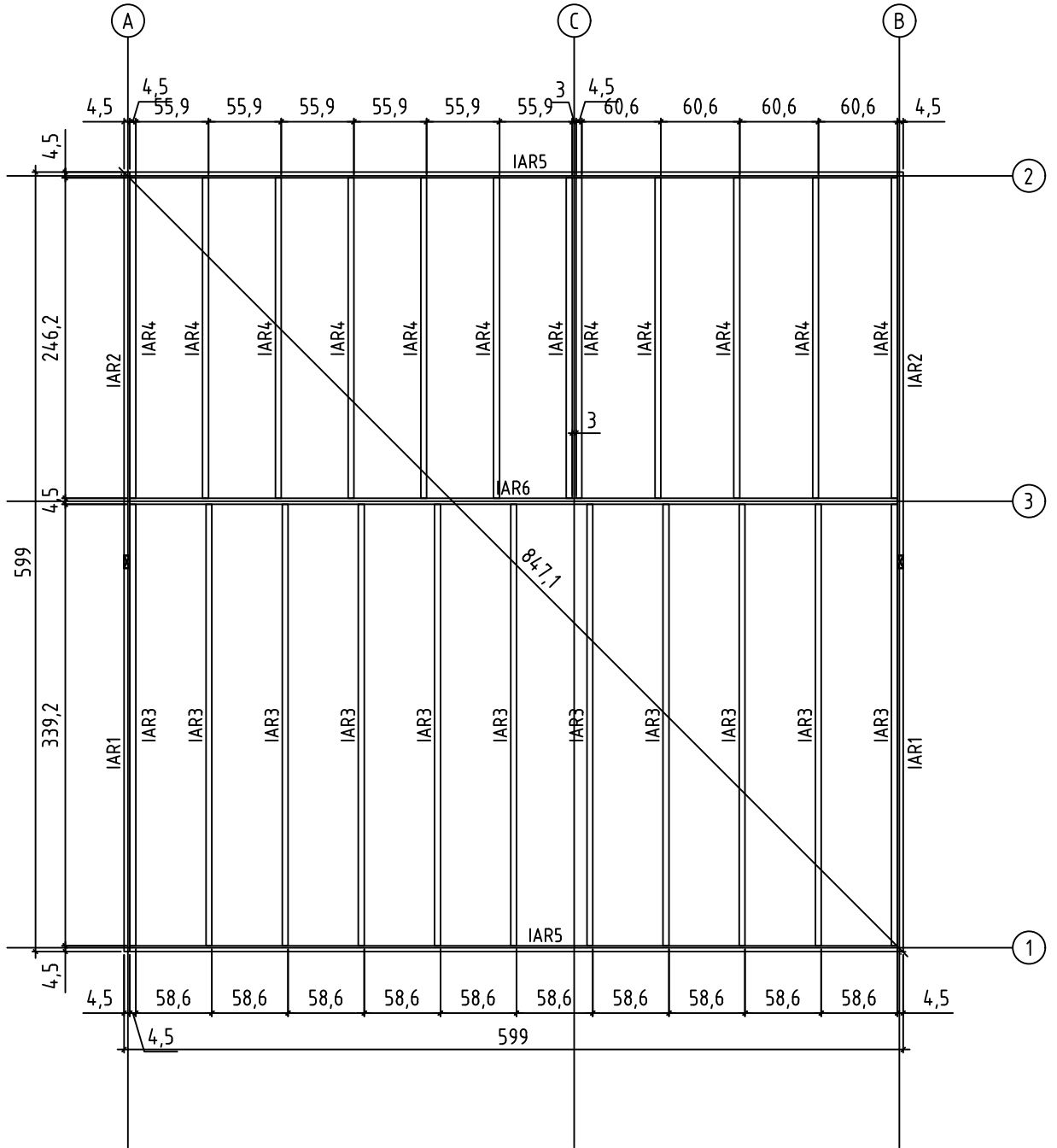

VALGA, Art.No.703341  
MEZZANINE FLOOR JOISTS -HALBGESCHOSS BALKEN - SOLIVES DE PLANCHER MEZZANINE

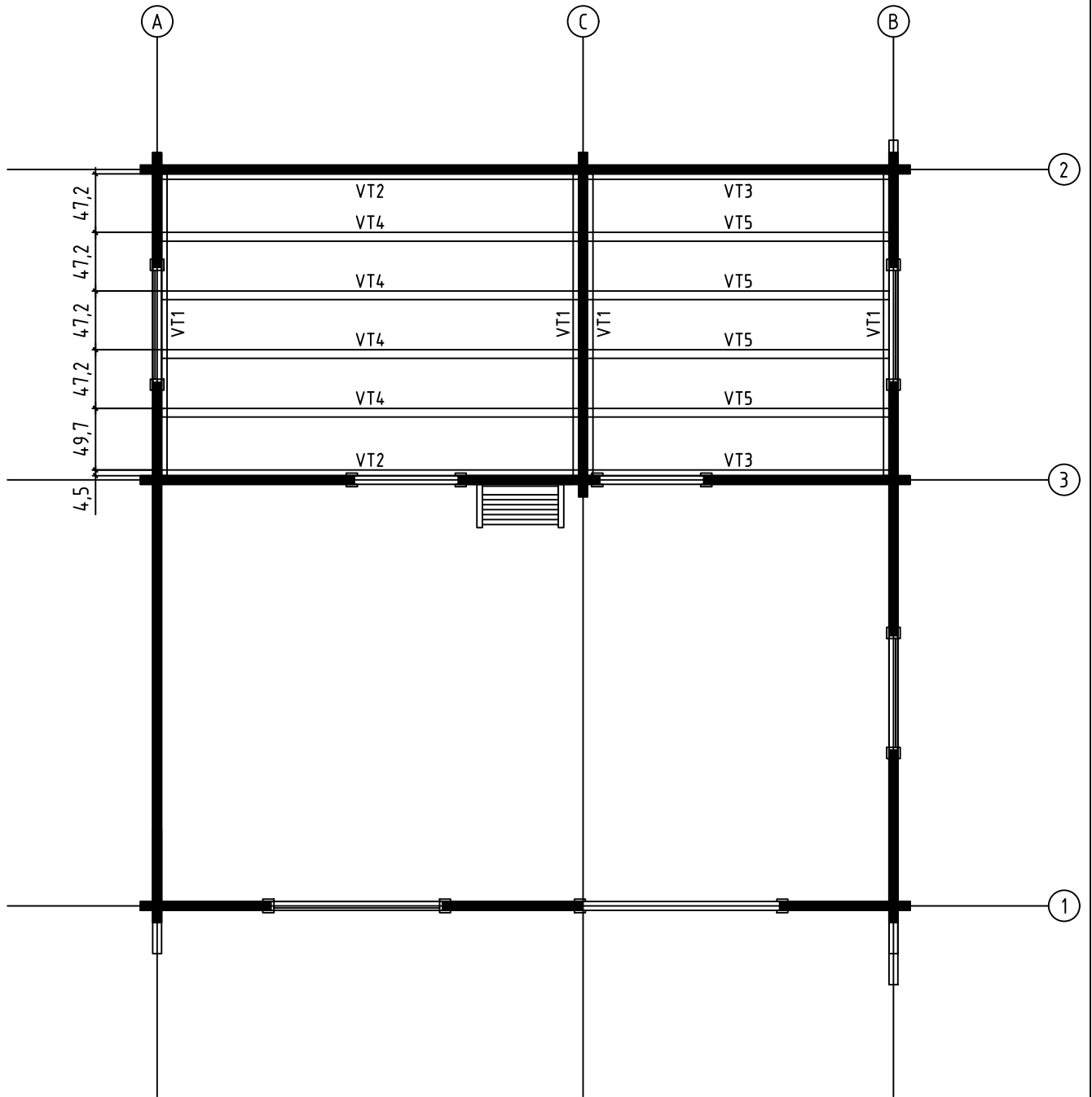

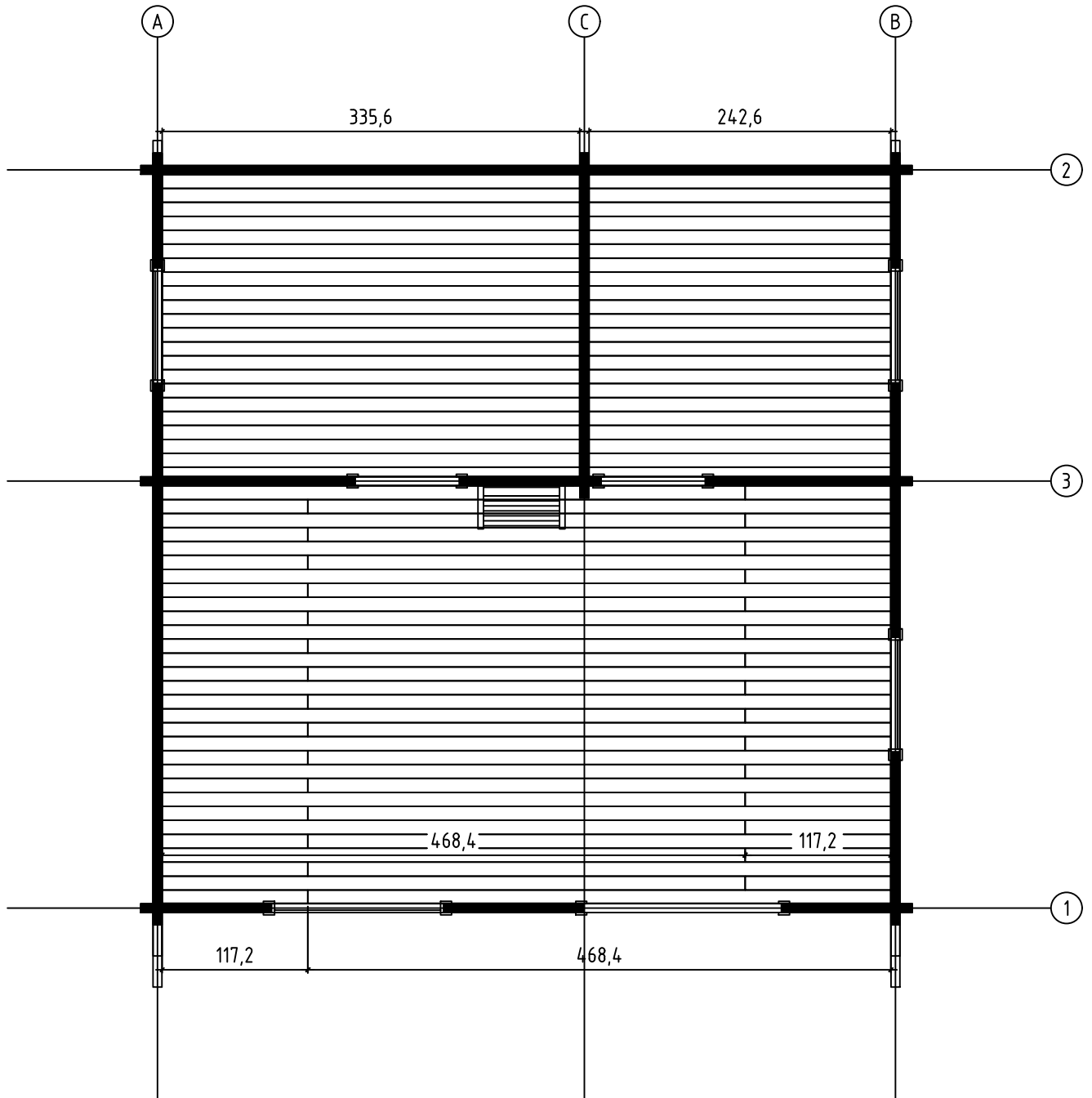

VALGA, Art.No.703341

1<sup>st</sup> FLOOR FLOOR BOARDS - FUSSBODENBRETTER ERSTE STOCK - PLAN POSE PLANCHER 1ÈRE ETAGE

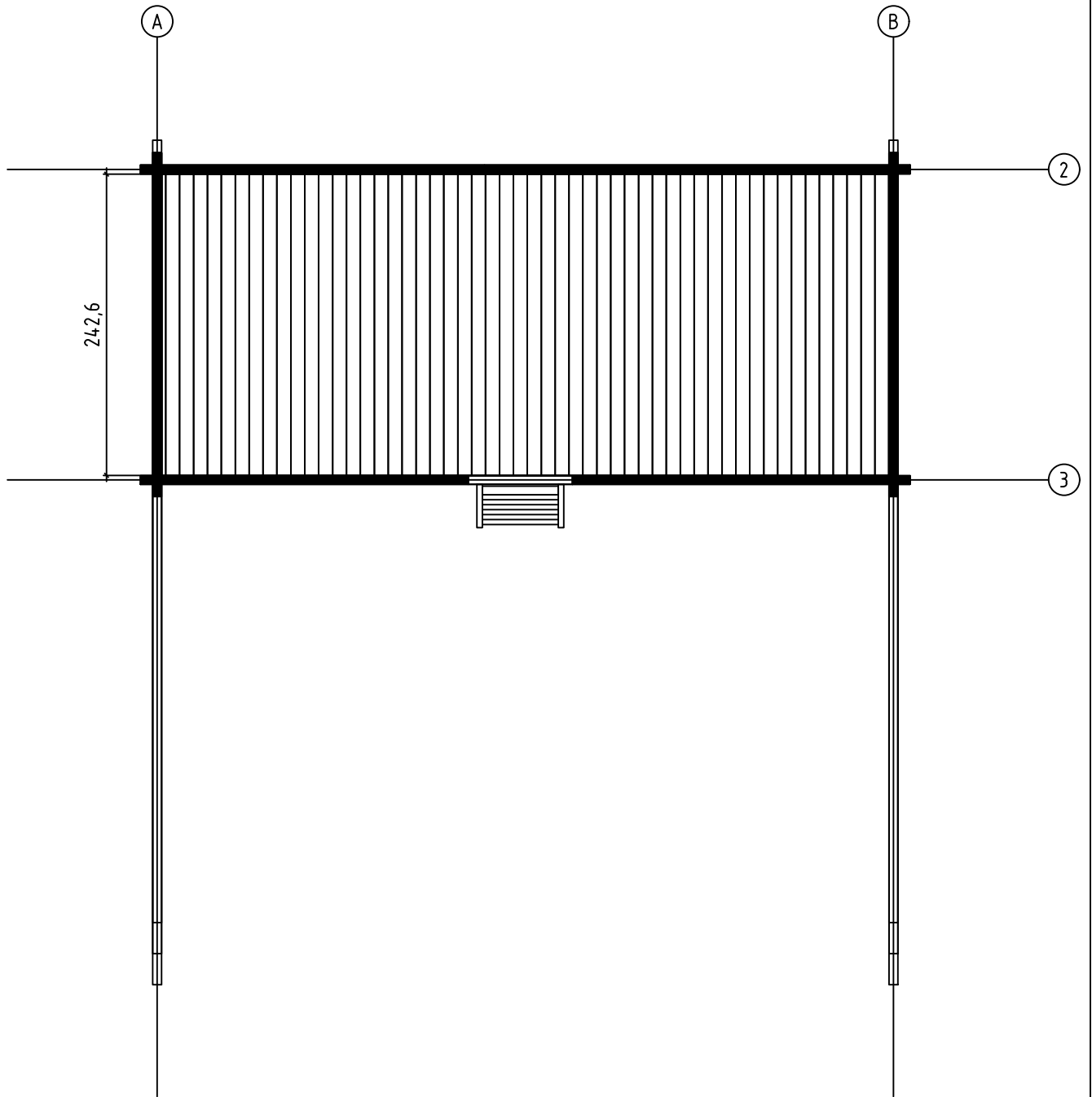

VALGA, Art.No.703341

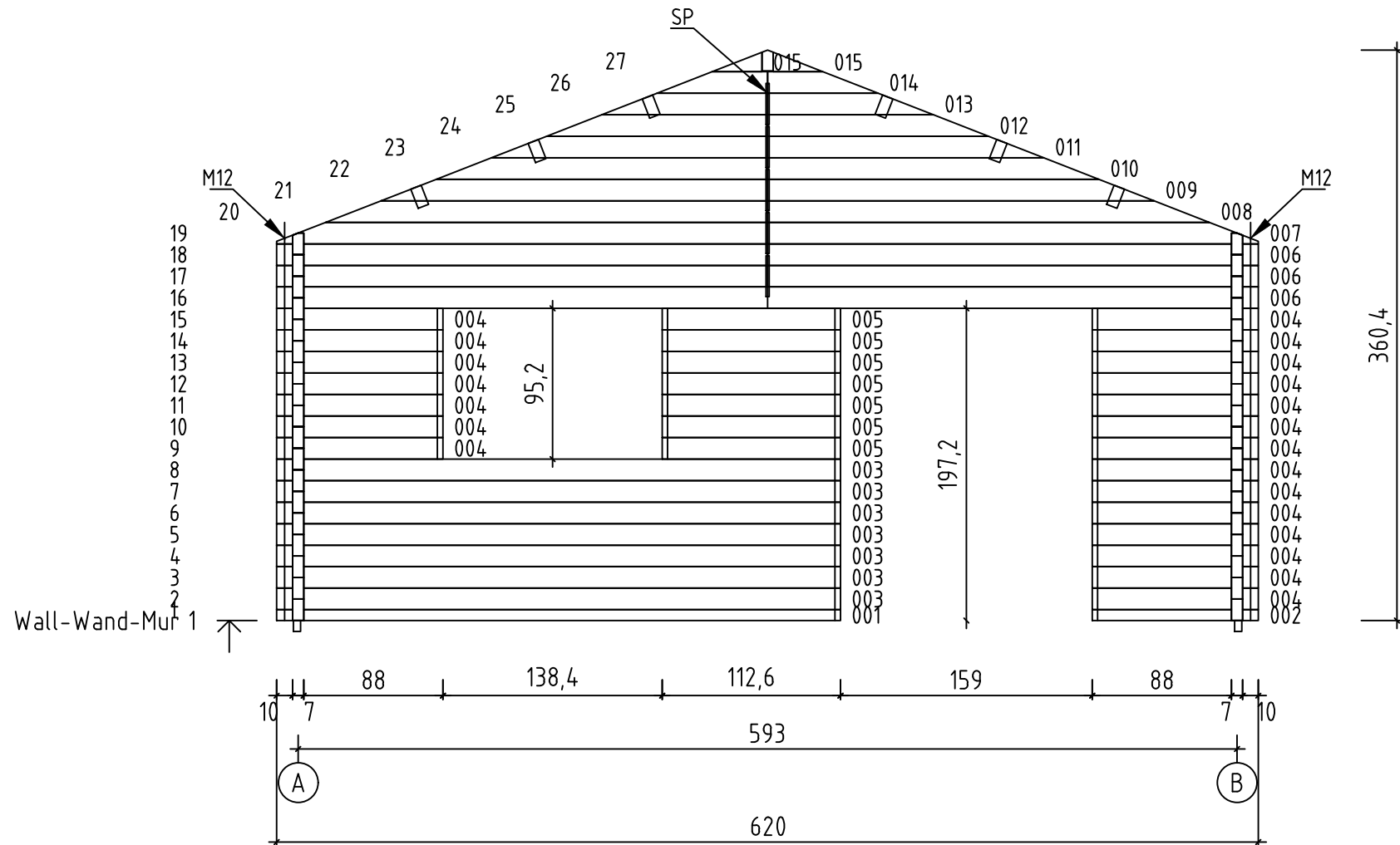





VALGA, Art.No.703341

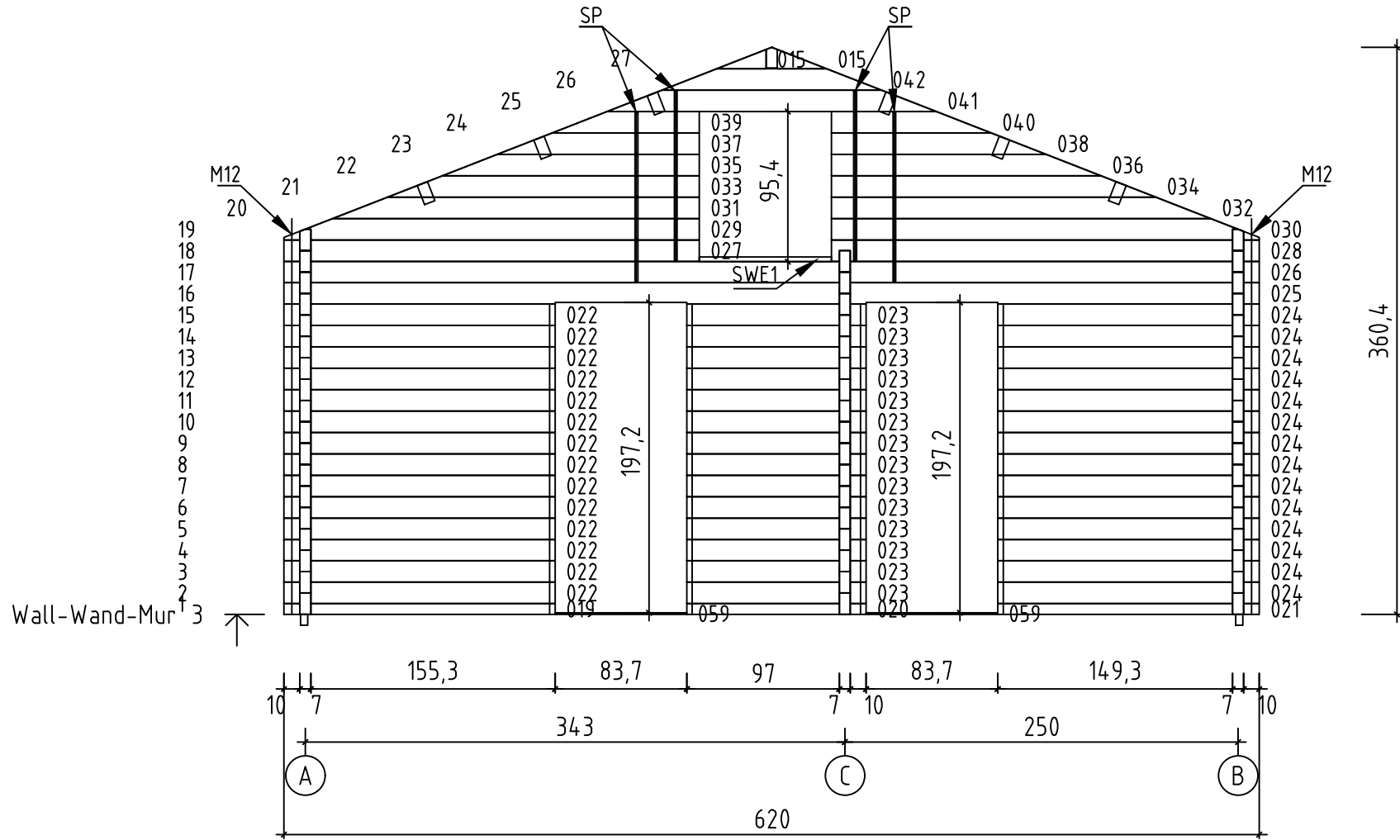

VALGA, Art.No.703341

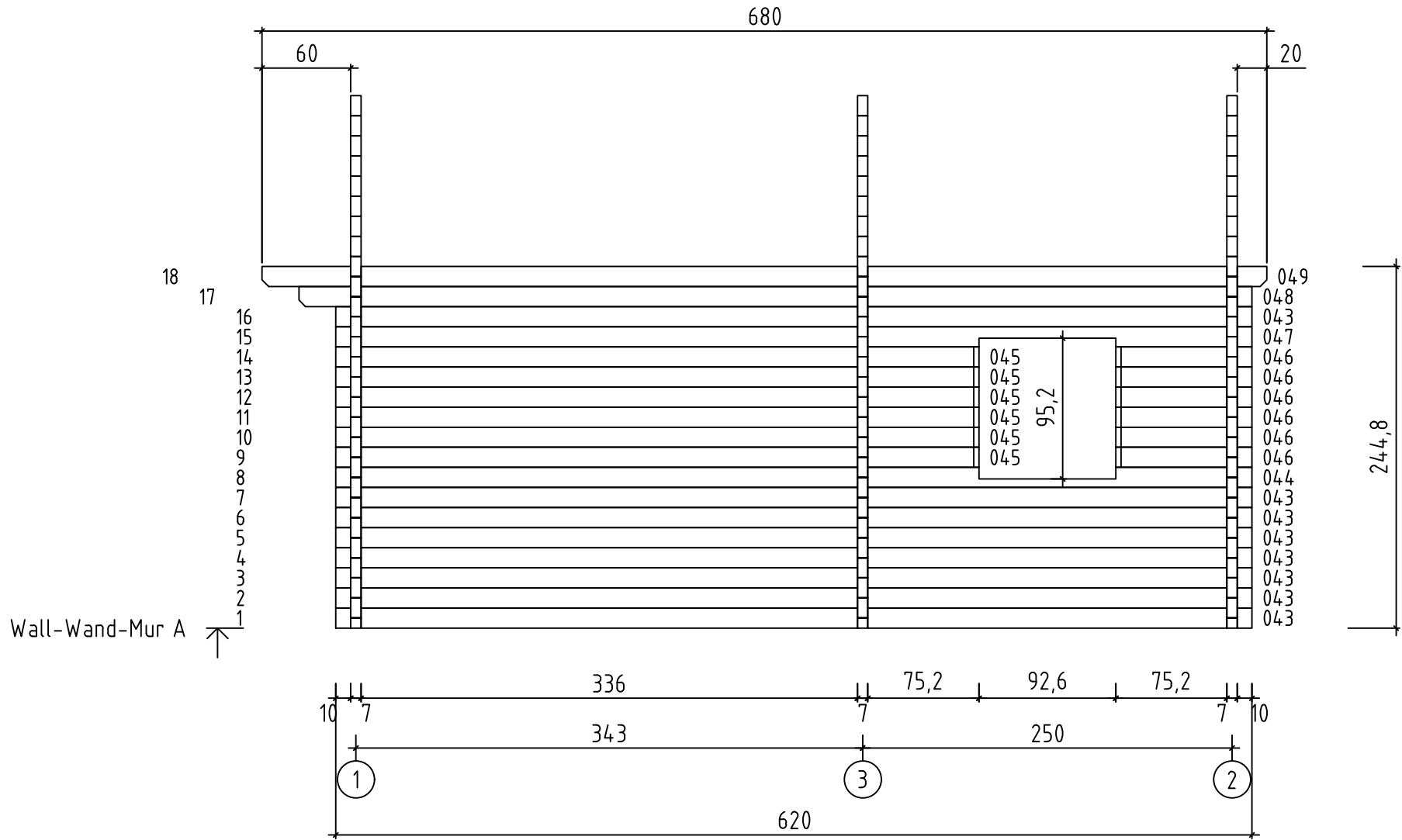

VALGA, Art.No.703341

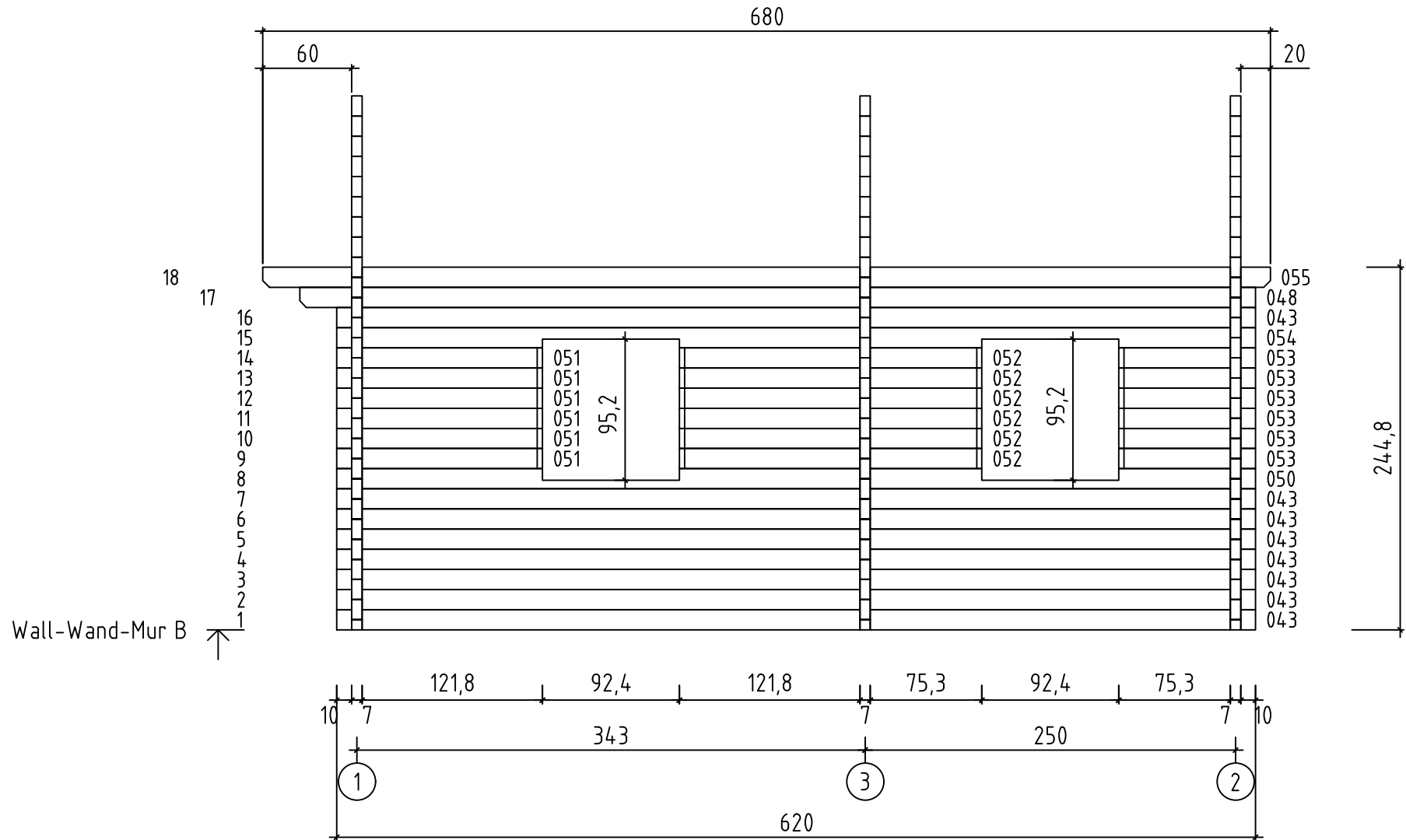



Wall-Wand-Mur B

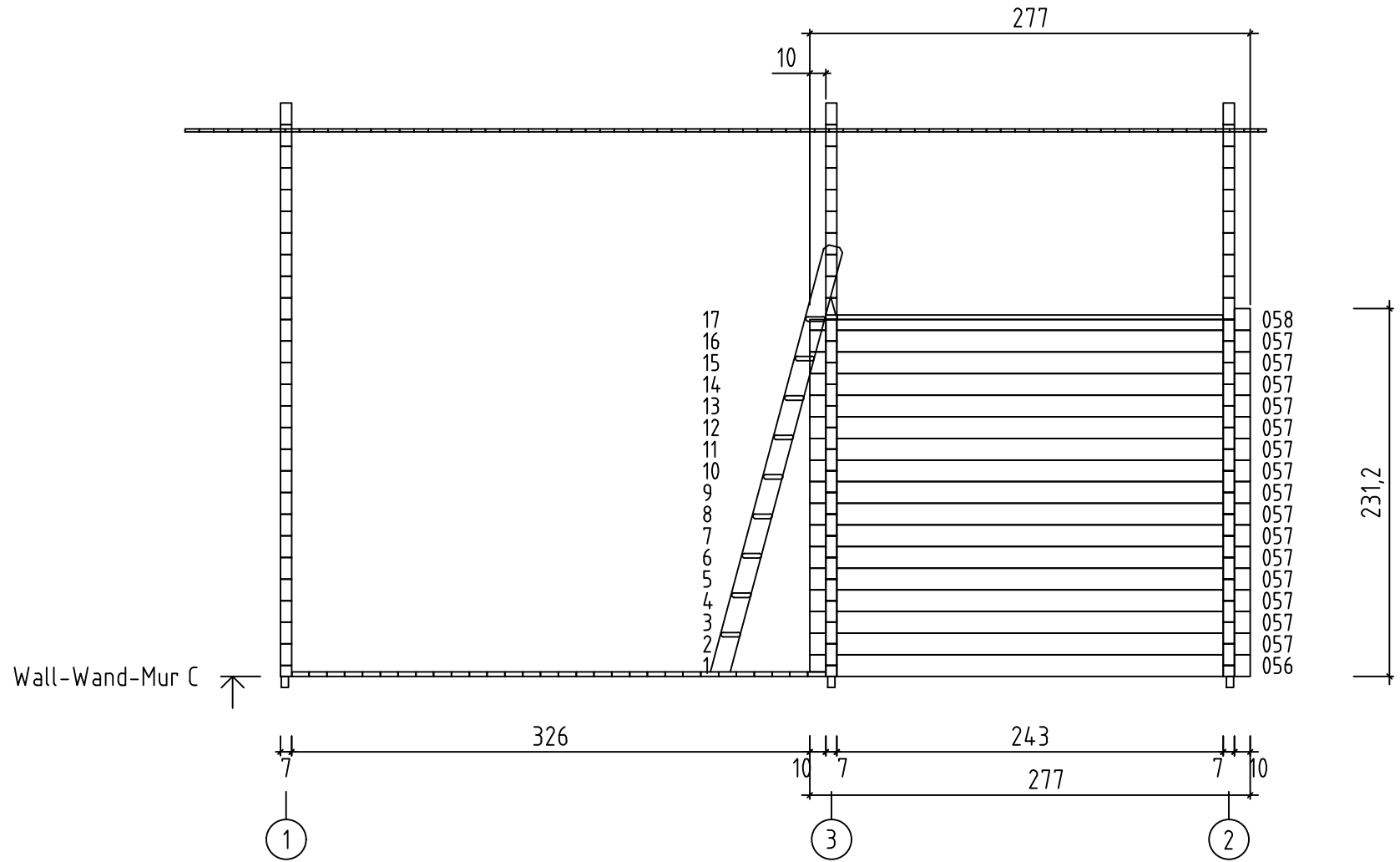



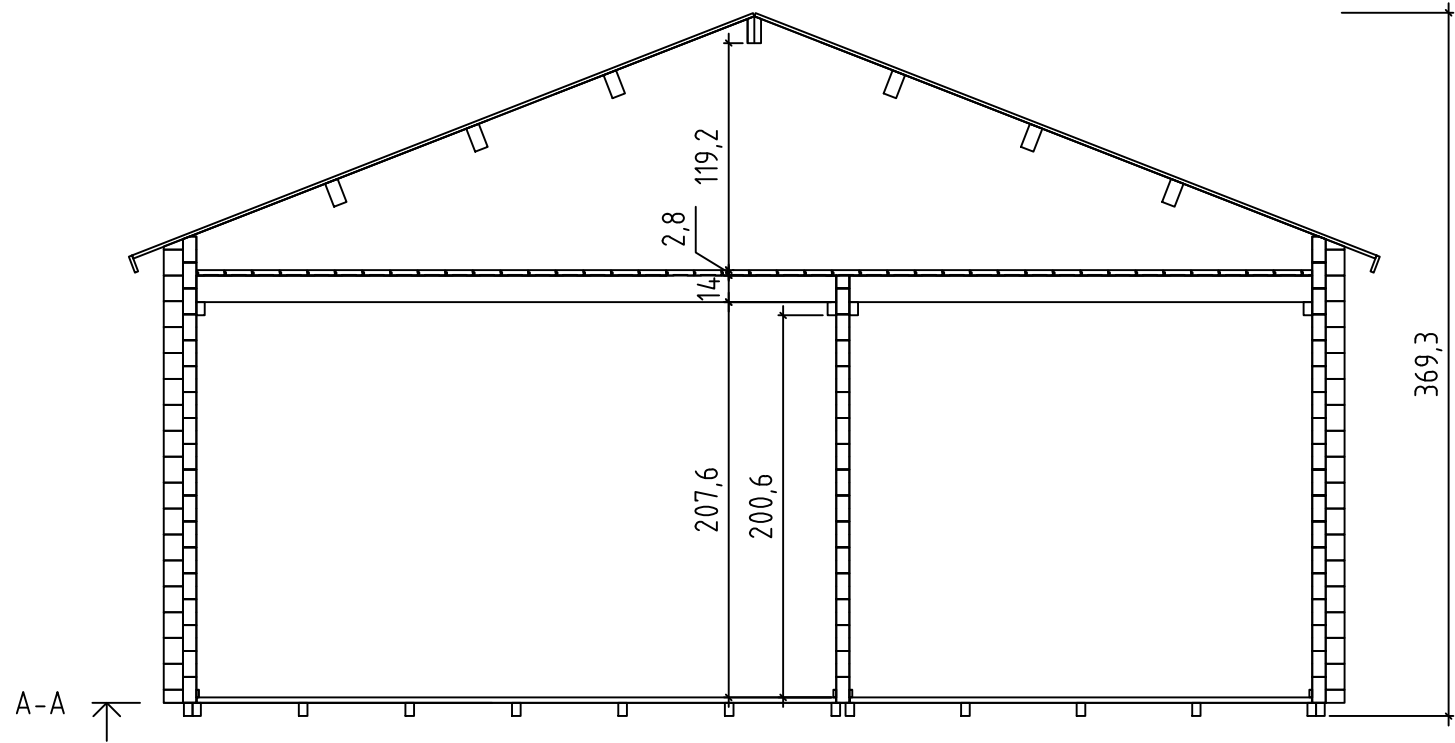

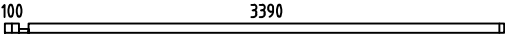
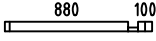
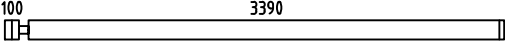
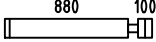
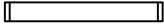
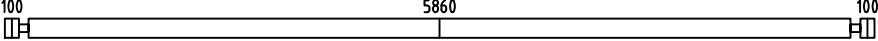
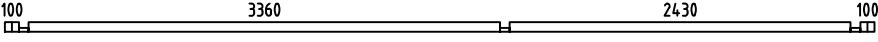
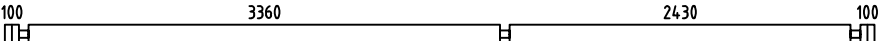
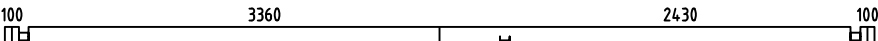
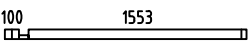
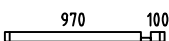
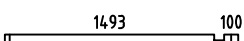
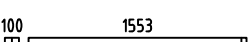
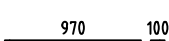

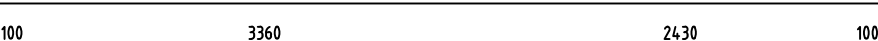
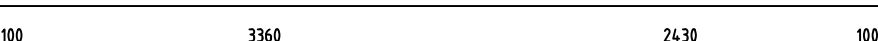
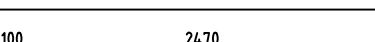
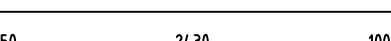
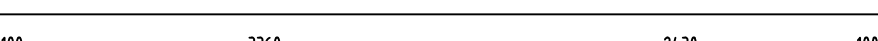
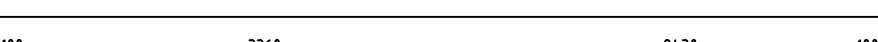
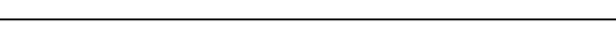
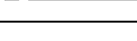
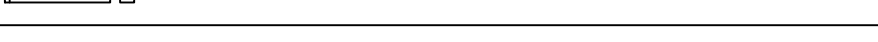
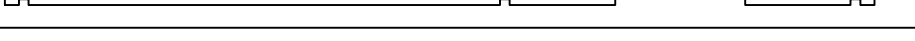

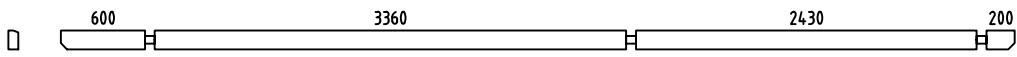
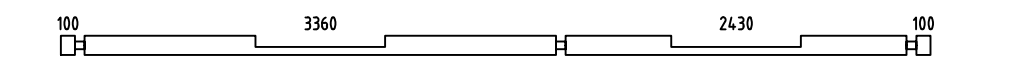
VALGA, Art.No.703341

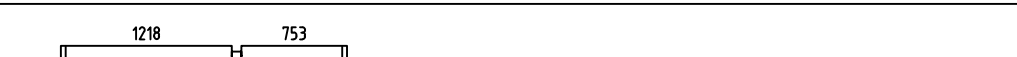

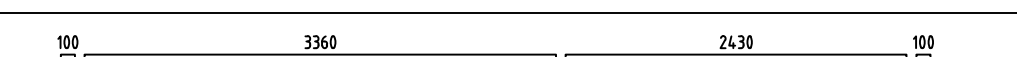
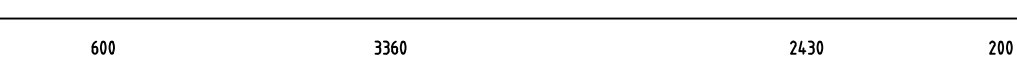
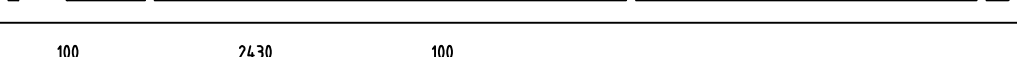
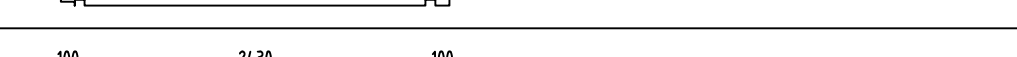
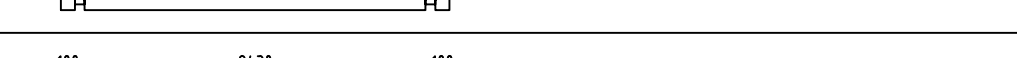
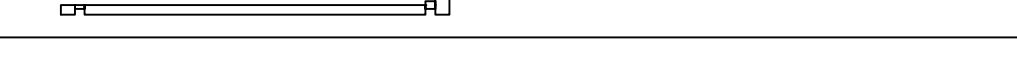
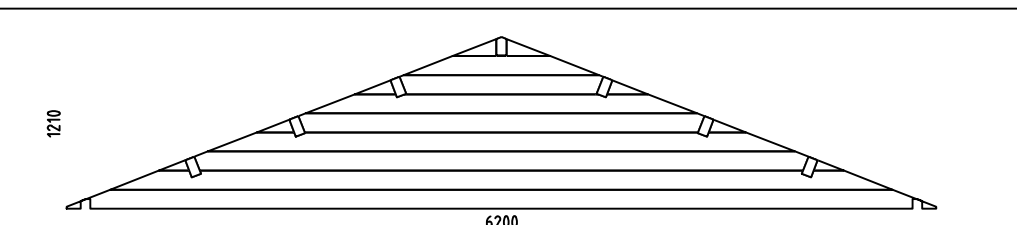
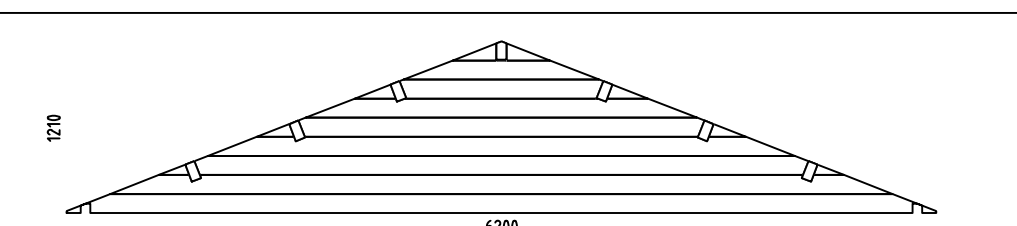
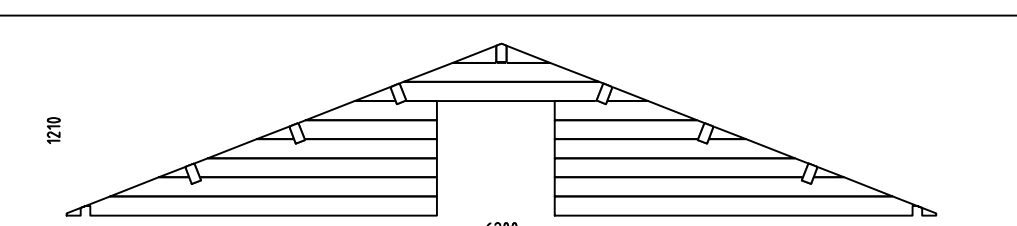

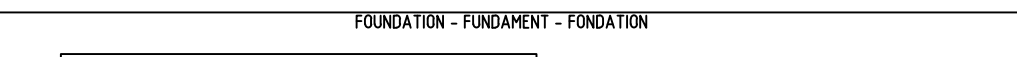







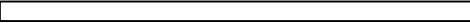
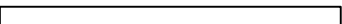

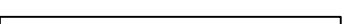

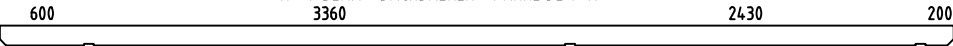
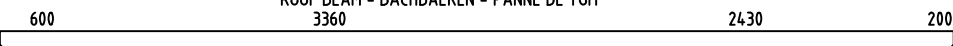



VALGA, Art.No.703341



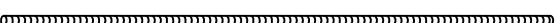

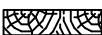
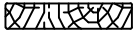



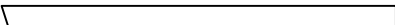







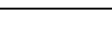
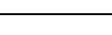
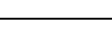
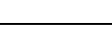

Pos	VALGA, Art.No.703341 Piece list - Stückliste - Liste des pieces	Q.	P (mm)	L (mm)
001		1	70x68	3560
002		1	70x68	1050
003		7	70x136	3560
004		21	70x136	1050
005		7	70x136	1126
006		3	70x136	6200
016		1	70x68	6200
017		16	70x136	6200
018		1	70x136	6200
019		1	70x68	1723
020		1	70x68	1140
021		1	70x68	1663
022		14	70x136	1723
023		14	70x136	1140
024		14	70x136	1663
025		1	70x136	6200
026		1	70x136	6200
027		1	70x136	2640
028		1	70x136	2720
043		16	70x136	6200
044		1	70x136	6200
045		6	70x136	4352
046		6	70x136	922
047		1	70x136	6200
048		2	70x136	6450

Pos	VALGA, Art.No.703341 Piece list - Stückliste - Liste des pieces	Q.	P (mm)	L (mm)
049		1	70x136	6800
050		1	70x136	6200
051		6	70x136	1388
052		6	70x136	2041
053		6	70x136	923
054		1	70x136	6200
055		1	70x136	6800
056		1	70x136	2770
057		15	70x136	2770
058		1	70x136	2770
059		2	70x10	837
W1-1		1		
W2-1		1		
W3-1		1		
IAR5	FOUNDATION - FUNDAMENT - FONDATION 	3	45x70	5900
IAR3	FOUNDATION - FUNDAMENT - FONDATION 	11	45x70	3393
IAR2	FOUNDATION - FUNDAMENT - FONDATION 	2	45x70	3045
IAR1	FOUNDATION - FUNDAMENT - FONDATION 	2	45x70	3045
IAR4	FOUNDATION - FUNDAMENT - FONDATION 	12	45x70	2463

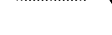
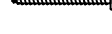

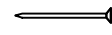
Pos	VALGA, Art.No.703341 Piece list - Stückliste - Liste des pieces	Q.	P (mm)	L (mm)
VT4	MEZZANINE FLOOR JOISTS - HALBGESCHOSS BALKEN - SOLIVES DE PLANCHER MEZZANINE 	4	70x140	3360
VT5	MEZZANINE FLOOR JOISTS - HALBGESCHOSS BALKEN - SOLIVES DE PLANCHER MEZZANINE 	4	70x140	2430
VT2	MEZZANINE FLOOR JOISTS - HALBGESCHOSS BALKEN - SOLIVES DE PLANCHER MEZZANINE 	2	45x140	3360
VT3	MEZZANINE FLOOR JOISTS - HALBGESCHOSS BALKEN - SOLIVES DE PLANCHER MEZZANINE 	2	45x140	2430
VT1	MEZZANINE FLOOR JOISTS - HALBGESCHOSS BALKEN - SOLIVES DE PLANCHER MEZZANINE 	4	45x70	2430
PR1	ROOF BEAM - DACHBALKEN - PANNE DE TOIT 	1	70x140	6800
A-PR1	ROOF BEAM - DACHBALKEN - PANNE DE TOIT 	6	70x140	6800
PTL	FLOOR BOARDS - FUSSBODENBRETTER - LAME DE PLANCHER 	30	112x28	4684
PTL	FLOOR BOARDS - FUSSBODENBRETTER - LAME DE PLANCHER 	22	112x28	3356
PTL	FLOOR BOARDS - FUSSBODENBRETTER - LAME DE PLANCHER 	75	112x28	2426
PTL	FLOOR BOARDS - FUSSBODENBRETTER - LAME DE PLANCHER 	30	112x28	1172
	ROOF BOARDS - DACHBRETTER - VOLIGES 	152	90x18	3500
	FLOOR FILLET-FUSSBODENLEISTE - CORNIERE DE FINITION DU PLANCHER 		15x40	56.3 m.
DPL	ROOFING FELT FILLET - DACHPAPPENLEISTE - BAGUETTE DE FIXATION DU FEUTRE BITUMEUX 	4	18x58	3550
M12	TREADED ROD M12 - GEWINDESTANGE M12 - TIGE FILETÉE M12 	6		445
M12	TREADED ROD M12 - GEWINDESTANGE M12 - TIGE FILETÉE M12 	6		2000
LPL	FIXING FILLET - FIXIRUNGSLEISTE - PROFIL DE FIXATION 	2	18x70	791
LPL	FIXING FILLET - FIXIRUNGSLEISTE - PROFIL DE FIXATION 	4	18x70	1933
SWE1	DOORSTEP - SWELLE - SEUIL DE PORTE 	1	28x74	840
TB	EAVES BOARD - TRAUFBRETT - BANDEAU DE TOIT 	4	18x90	3400
DRV	ROOF EDGE REINFORCEMENT - DACHRANDVERSTÄRKUNG - CORNIERE DE RENFORT DE BORD DE TOIT 	4	28x34	3400
TBE6	FIXING FILLET FOR WINDOW - FIXIRUNGSLEISTE FÜR FENSTER - PROFIL DE FIXATION DES FENETRES 	6	28x34	748
TBE6	FIXING FILLET FOR WINDOW - FIXIRUNGSLEISTE FÜR FENSTER - PROFIL DE FIXATION DES FENETRES 	2	28x34	916
TBE6	FIXING FILLET FOR DOOR - FIXIRUNGSLEISTE FÜR TÜR - PROFIL DE FIXATION DES PORTES 	6	28x34	1923
GL	GABLE MOULDING - GIEBELLEISTE PLANCHE DE RIVE 	4	18x120	3550

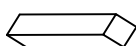
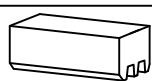
Pos	VALGA, Art.No.703341 Piece list - Stückliste - Liste des pieces		Q.	P (mm)	L (mm)
KL4	LENGTHENING BOLT FOR TREADED ROD - VERLÄNGERUNGSMUTTER FÜR GEWINDESTANGE - MANCHON DE RACCORDEMENT DE TIGE FILETÉE		6		
KL1	DRIVE NUT TREADED ROD - EINSHLAGMUTTER FÜR GEWINDESTANGE - ÉCROU A FRAPPER POUR TIGE FILETÉE		6		
KL2	NUT FOR TREADED ROD - MUTTER FÜR GEWINDESTANGE - ÉCROU POUR TIGE FILETÉE		6		
KL3	PLAIN WASHER TREADED ROD - UNTERLEGSCHIEBE FÜR GEWINDESTANGE - RONDELLE PLATE POUR TIGE FILETÉE		6		
HS12	SCREW FOR GABLE SEGMENT - SCHRAUBEN FÜR DECKBLATT - VIS POUR FIXATION LOSANGE DE FINITION		4	3.5x35	
HS83	SCREW FOR FIXING FILLET - SCHRAUBEN FÜR FIXIRUNGSLEISTE - VIS POUR PROFIL DE FIXATION		26	3.5x50	
HS17	SCREW FOR FLOOR BOARDS - SCHRAUBEN FÜR FUSSBODENBRETTER - VIS D'ASSEMBLAGE DES LAMES DE PLANCHER		4	3.5x50	
HS84	SCREW FOR FIXING FILLET - SCHRAUBEN FÜR FIXIRUNGSLEISTE - VIS POUR PROFIL DE FIXATION		62	3.5x50	
HS16	SCREW FOR GABLE MOULDING - SCHRAUBEN FÜR GIEBELLEISTE - VIS DE FIXATION POUR PLANCHE DE RIVE		40	3.5x50	
HS32	SCREW FOR EAVES BOARDS - SCHRAUBEN FÜR TRAUFBRETTER - VIS DE FIXATION POUR BANDEAU DE TOIT		32	4x40	
HS26	SCREW FOR ROOF EDGE REINFORCEMENT - SCHRAUBEN FÜR DACHRANDVERSTÄRKUNG - VIS POUR RENFORT DE BORD DE TOIT		32	4x40	
HS36	SCREW FOR STEPLADDER - SCHRAUBE FÜR LEITER - VIS D'ASSEMBLAGE DES MARCHES DE L'ECHELLE		36	4x60	
HS86	SCREW FOR MEZZANINE FLOOR JOISTS - SCHRAUBEN FÜR HALBGESCHOSS BALKEN - VIS DE FIXATION SOLIVES DE PLANCHER MEZZANINE		72	5x100	
HS40	SCREW FOR 1. WALL BEAM - SCHRAUBE FÜR 1. BOHLENREIHE - VIS DE FIXATION DES FONDATIONS		18	5x120	
HS42	SCREW FOR GABLE - SCHRAUBEN FÜR GIEBEL - VIS POUR FIXATION DES PIGNONS		48	5x120	
HS43	SCREW FOR ROOF BEAMS - SCHRAUBEN FÜR DACHBALKEN - VIS POUR PANNE DE TOIT		21	5x120	
HS39	SCREW FOR FUNDAMENT - SCHRAUBEN ZUR BEFESTIGUNG FUNDAMENT - VIS POUR FONDATION		66	5x90	
MS	SCREW FOR DOORSTEP - SCHRAUBEN FÜR TÜRSCHWELLE - VIS DE FIXATION DU SEUIL DE PORTE		7	4.5x65	
NFD	ZN NAIL FOR ROOFING FELT FILLET - ZN NÄGEL FÜR DACHPAPPENLEISTE - POINTE POUR BAGUETTE FIXATION FEUTRE BITUMEUX		36	2x40	
NFF	ZN NAIL FOR FILLETS - ZN NÄGEL FÜR LEISTEN - POINTE POUR CORNIERE		110	1.4x40	
NF2	ZN NAIL FOR ROOF - ZN NÄGEL FÜR DACHBRETTER - POINTE POUR TOIT		1090	2x50	
NH1	ZN NAIL FOR FLOOR - ZN NÄGEL FÜR FUSSBODENBRETTER - CLOUS POUR PLANCHER		1121	2x50	
GS	GABLE SEGMENT-DECKBLATT - LOSANGE DE FINITION		2		
SP	HIDDEN FIXING - HOLZDÜBEL - TOURILLON BOIS		25		
SH70	HAMMER BLOCK - SCHLAGHOLZ - CALLE DE FRAPPE		2		

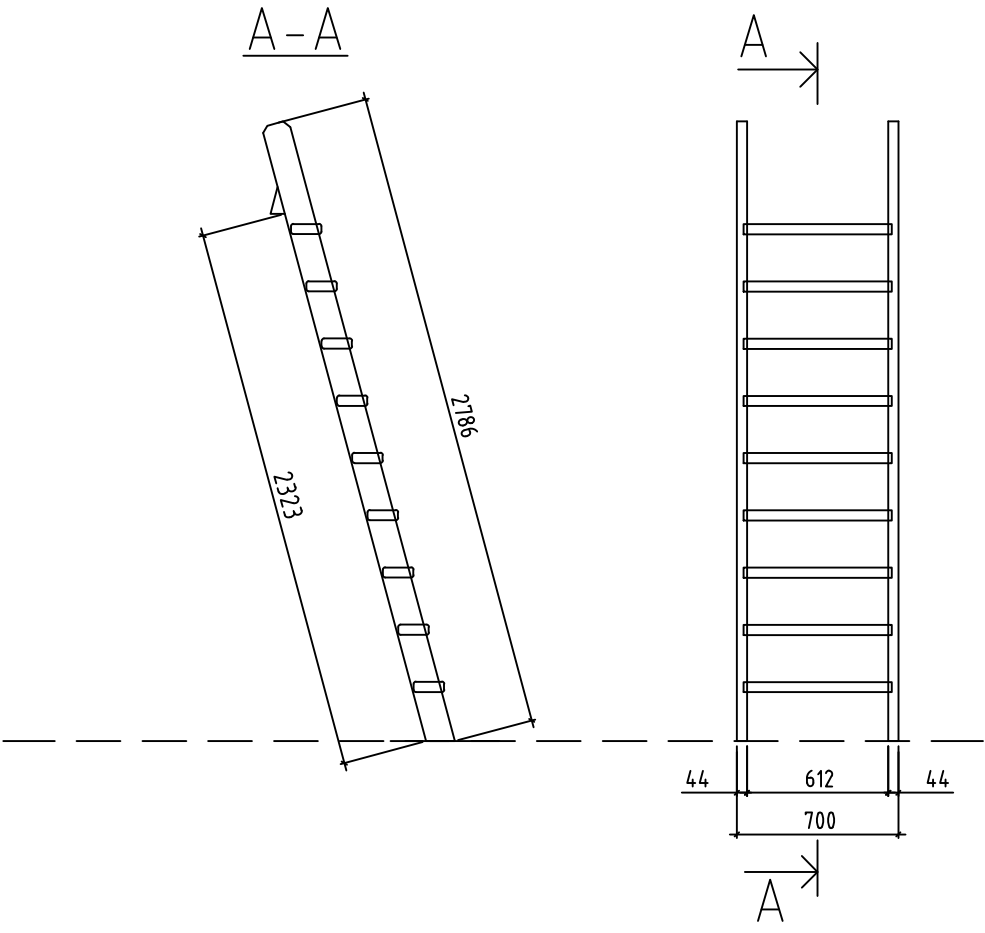
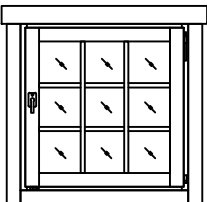
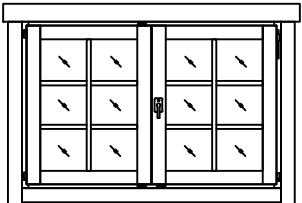
Pos	VALGA, Art.No.703341 Piece list - Stückliste - Liste des pieces	Q.	P (mm)	L (mm)
ORZ	MONTAGE SET FOR DOORS AND WINDOWS - MONTAGE-SET FÜR TÜREN UND FENSTER - JEU DE MONTAGE PORTES ET FENETRES	1		
LR	LADDER - LEITER - ECHELLE  	1		
2+ A.9P.K	WINDOW-FENSTER-FENETRE 916x916  	3		
2+ TA.6P.K	WINDOW-FENSTER-FENETRE 1374x916  	1		

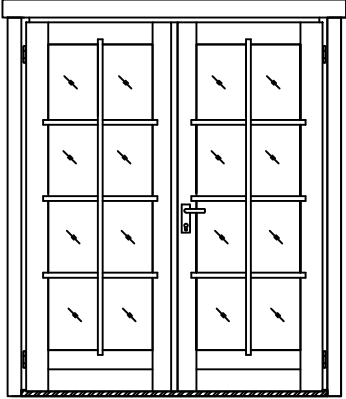
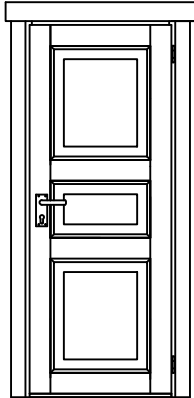
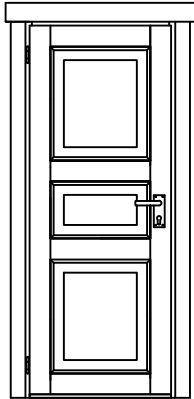
Pos	VALGA, Art.No.703341 Piece list - Stückliste - Liste des pieces	Q.	P (mm)	L (mm)
2+ TU.18P.K	DOOR-TÜR-PORTE 1580x1933 	1		
U.3TP	DOOR-TÜR-PORTE 827x1933 +LPL 	1		
U.3TV	DOOR-TÜR-PORTE 827x1933 +LPL 	1		

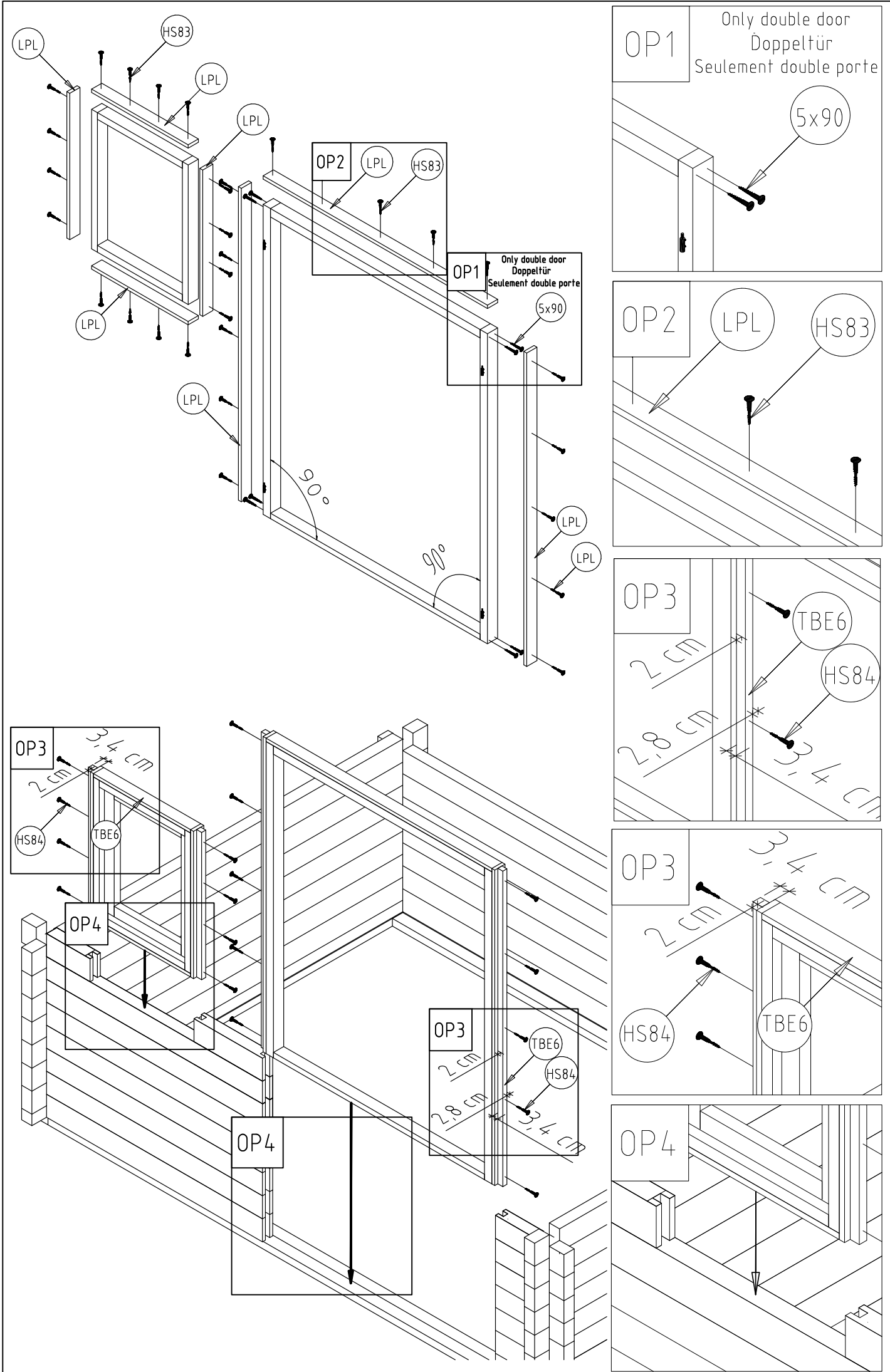

OP1 Only double door  
Doppeltür  
Seulement double porte

