

Orinoco
Art. Nr.702741

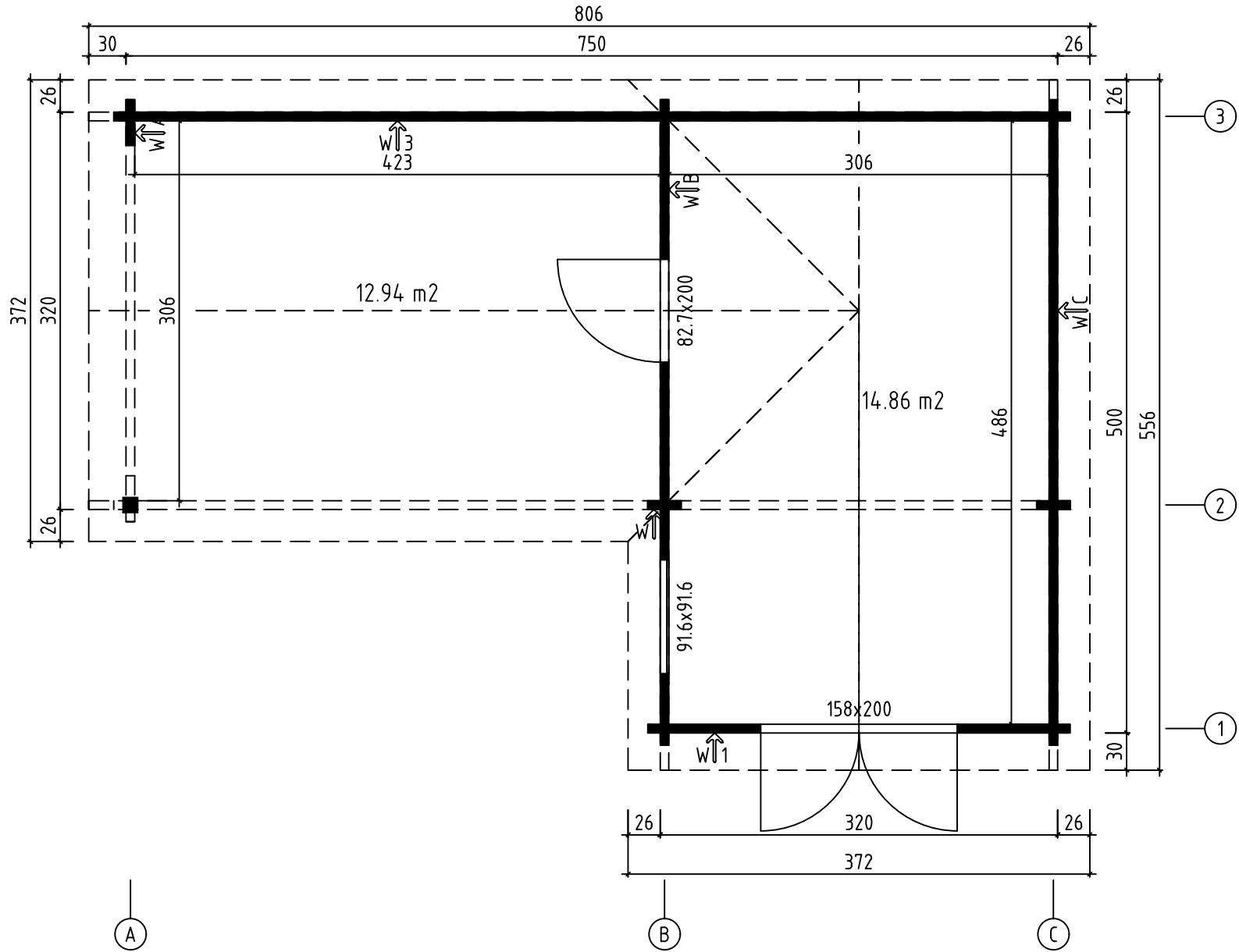

702741 - Orinoco

GROUNDPLAN - GRUNDPLAN - PLAN DE MASSE



702741 - Orinoco

FOUNDATION - FUNDAMENT - FONDATION

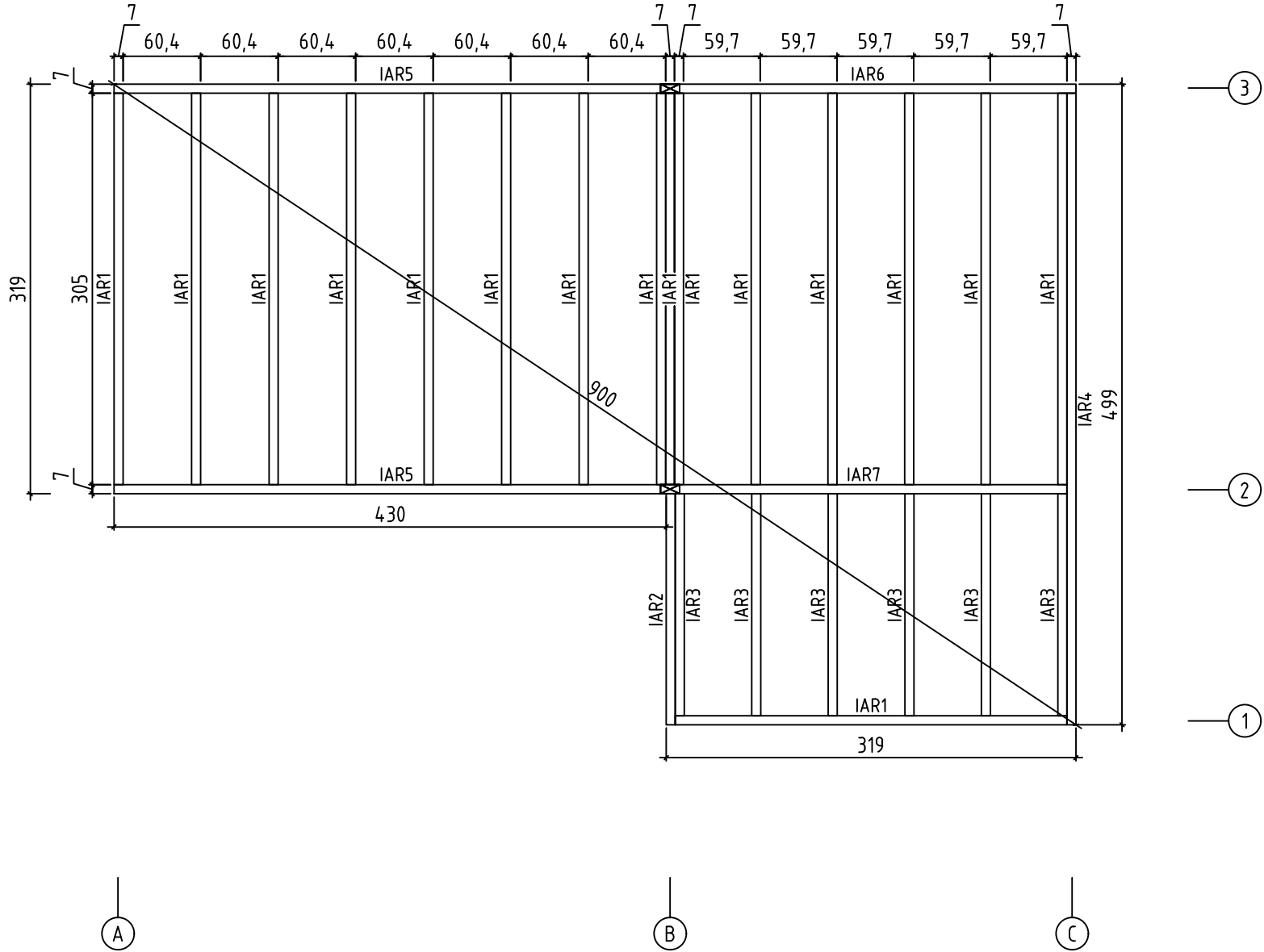

702741 - Orinoco

FLOOR BOARDS - FUSSBODENBRETTER - LAME DE PLANCHER

TERRACE BOARDS - TERRASSENBRETTER - PLANCHER DE
TERRASSE

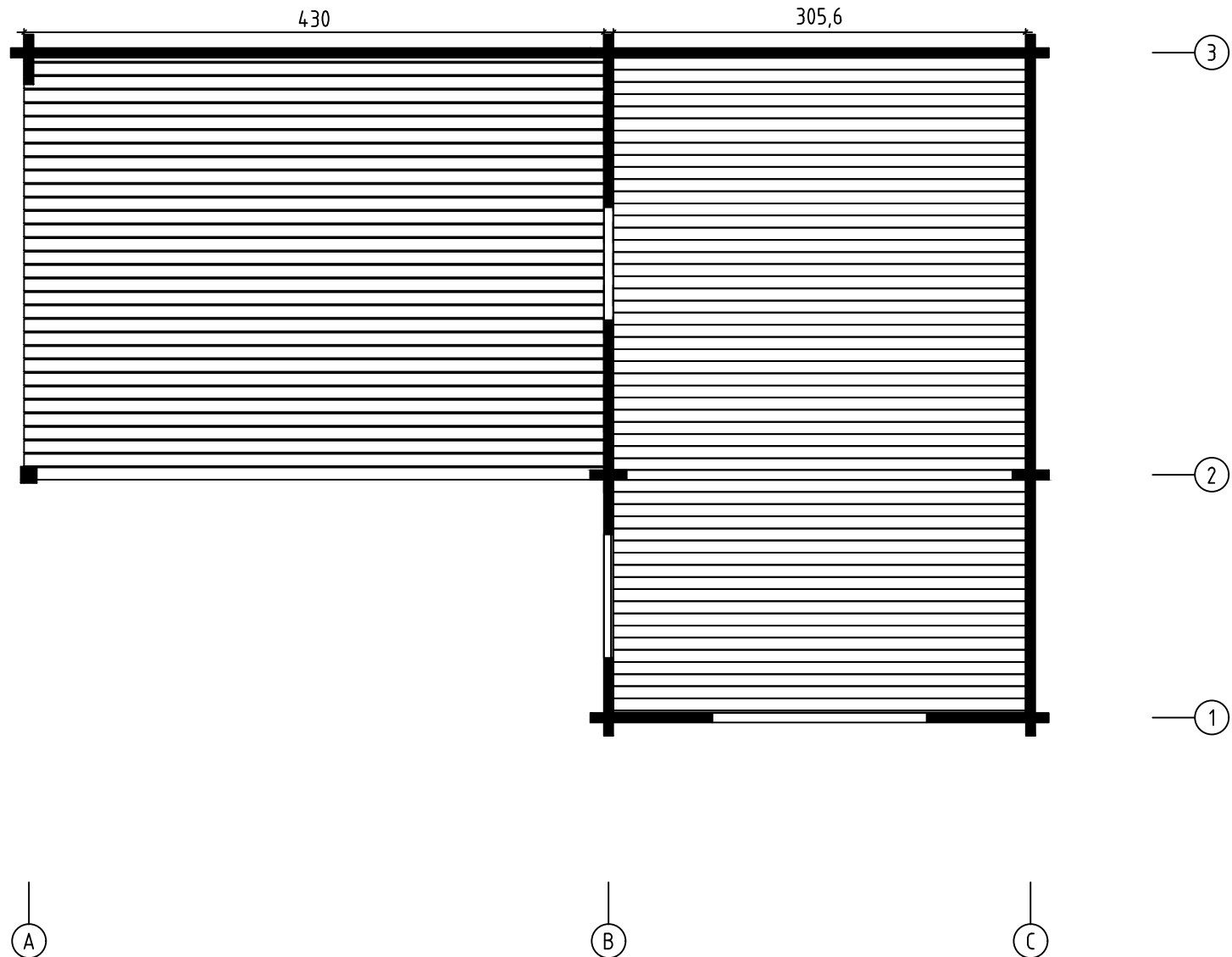

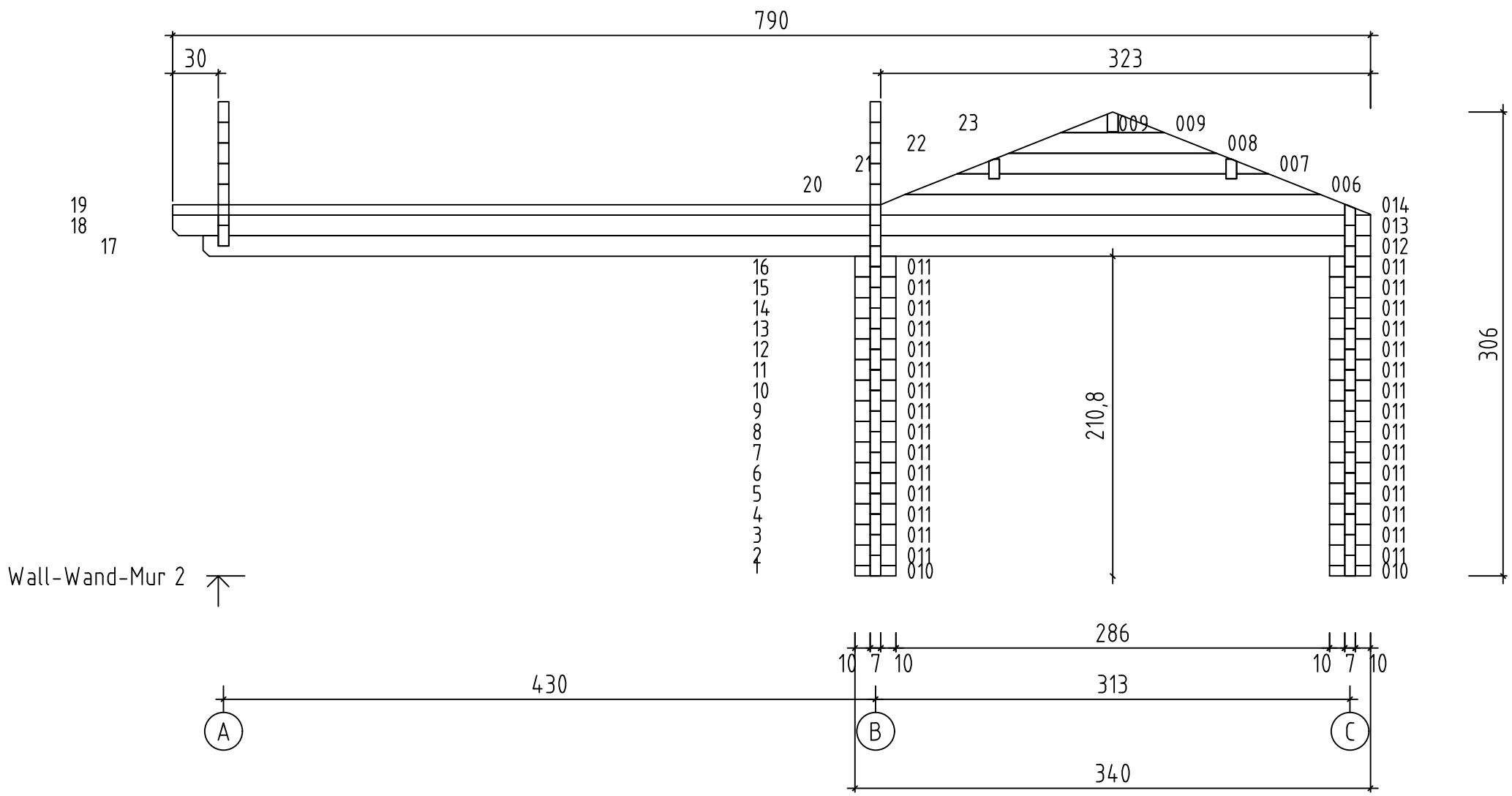

702741 - Orinoco

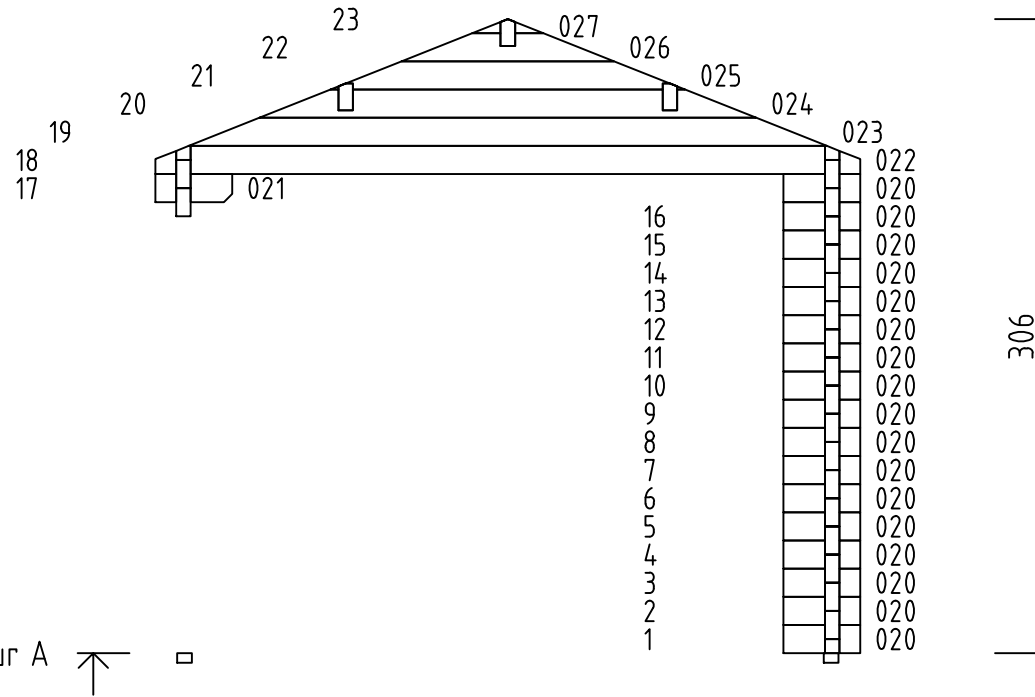

702741 - Orinoco



Wall-Wand-Mur A  

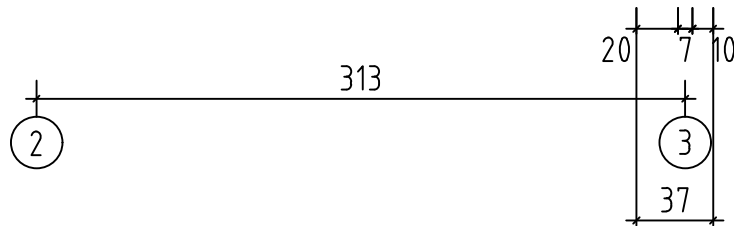



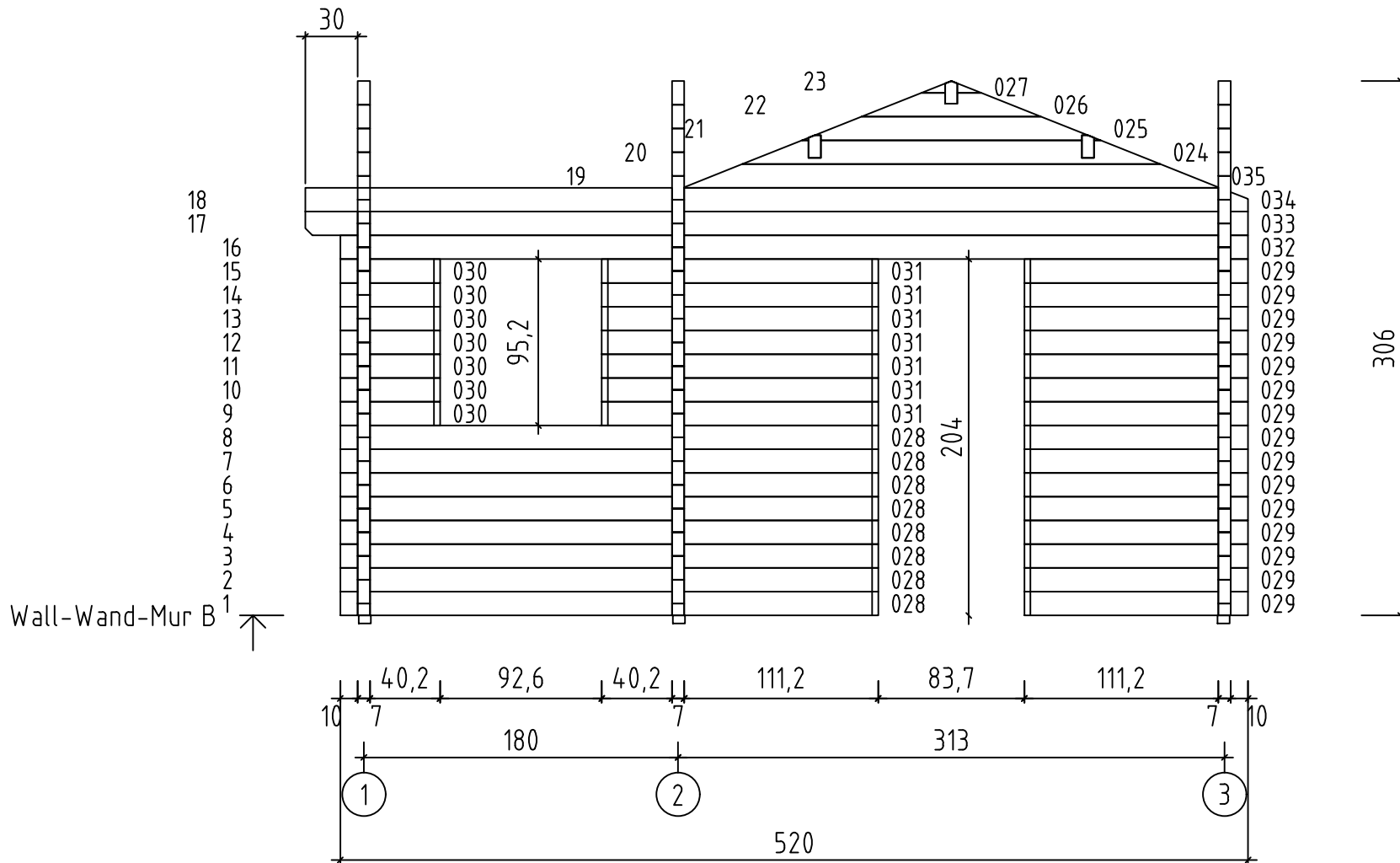



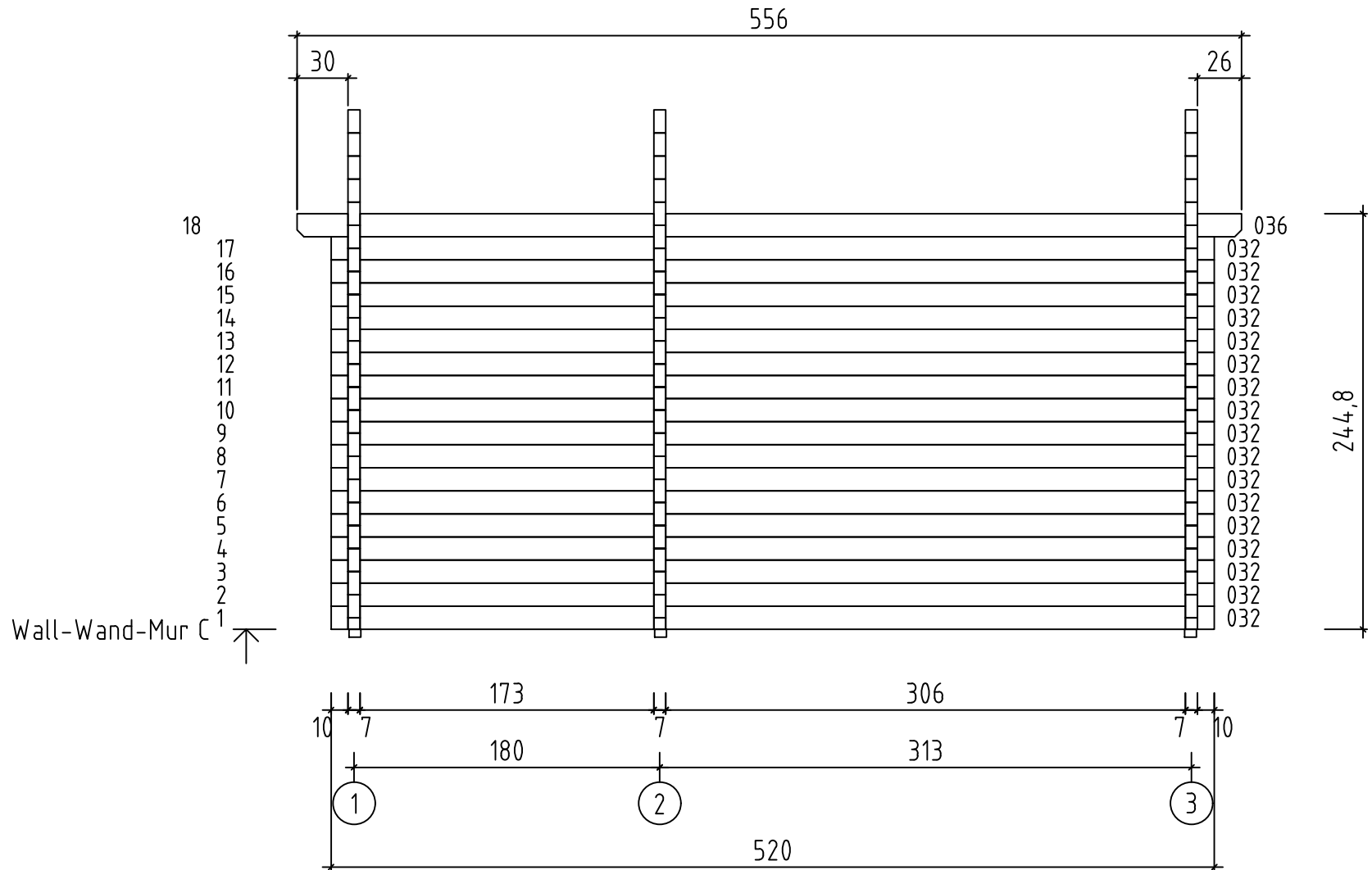

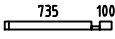
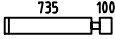
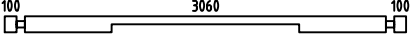
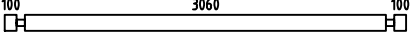

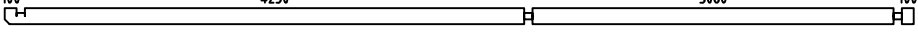
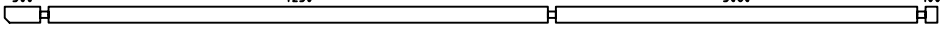
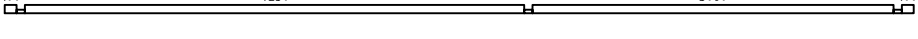
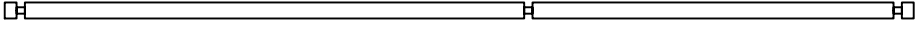

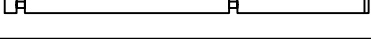
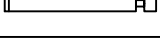

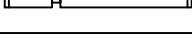
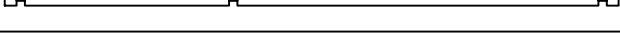
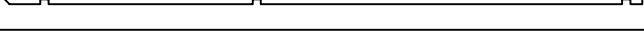
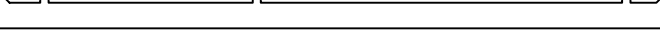
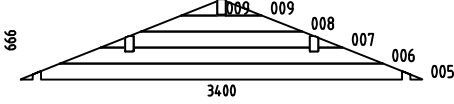
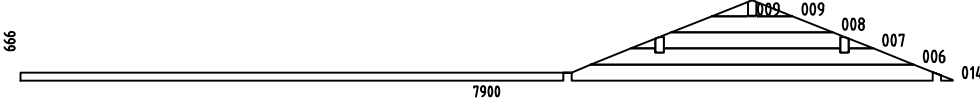
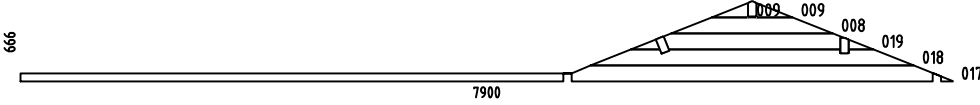

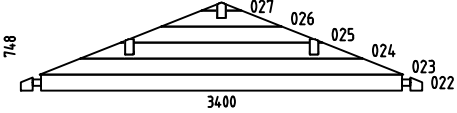
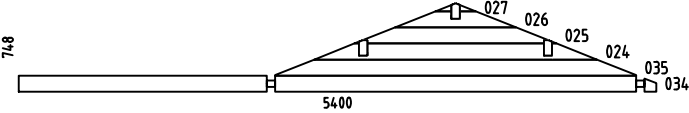





702741 - Orinoco

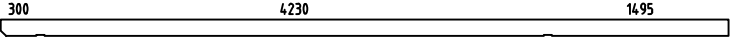
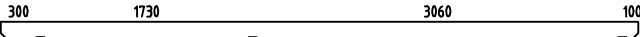
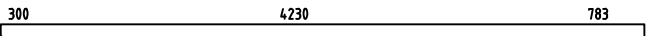
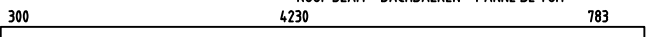
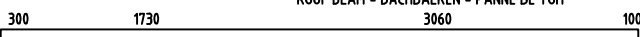
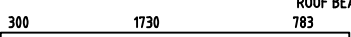
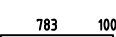





702741 - Orinoco

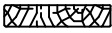
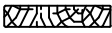
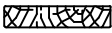

Pos	702741 - Orinoco Piece list - Stückliste - Liste des pieces	Q.	P (mm)	L (mm)
001		2	70x68	905
002		28	70x136	905
003		1	70x136	3400
004		2	70x136	3400
010		2	70x68	270
011		30	70x136	270
012		1	70x136	7700
013		2	70x136	7900
015		1	70x68	7700
016		16	70x136	7700
020		17	70x136	370
021		1	70x136	370
028		8	70x136	3082
029		15	70x136	1281
030		7	70x136	572
031		7	70x136	1583
032		18	70x136	5200
033		1	70x136	5400
036		1	70x136	5560
W1-1		1		
W2-1		1		
W3-1		1		

Pos	702741 - Orinoco Piece list - Stückliste - Liste des pieces	Q.	P (mm)	L (mm)
WA-1		1		
WB-1		1		
IAR4	FOUNDATION - FUNDAMENT - FONDATION 	1	70x45	4920
IAR5	FOUNDATION - FUNDAMENT - FONDATION 	2	70x45	4405
IAR6	FOUNDATION - FUNDAMENT - FONDATION 	1	70x45	3235
IAR7	FOUNDATION - FUNDAMENT - FONDATION 	1	70x45	3165
IAR1	FOUNDATION - FUNDAMENT - FONDATION 	16	70x45	3050
IAR2	FOUNDATION - FUNDAMENT - FONDATION 	1	70x45	1800
IAR3	FOUNDATION - FUNDAMENT - FONDATION 	6	70x45	1730
PR12	ROOF BEAM - DACHBALKEN - PANNE DE TOIT 	1	70x140	6165
PR11	ROOF BEAM - DACHBALKEN - PANNE DE TOIT 	1	70x140	5400
PR24	ROOF BEAM - DACHBALKEN - PANNE DE TOIT 	1	70x140	5453
PR25	ROOF BEAM - DACHBALKEN - PANNE DE TOIT 	1	70x140	5453
PR23	ROOF BEAM - DACHBALKEN - PANNE DE TOIT 	1	70x140	5400
PR21	ROOF BEAM - DACHBALKEN - PANNE DE TOIT 	1	70x140	2953
PR22	ROOF BEAM - DACHBALKEN - PANNE DE TOIT 	1	70x140	847
PR55	ROOF BEAM - DACHBALKEN - PANNE DE TOIT 	2	70x140	1055
PR56	ROOF BEAM - DACHBALKEN - PANNE DE TOIT 	2	70x140	953
FB-1	FLOOR BOARDS - FUSSBODENBRETTER - LAME DE PLANCHER 	55	90x18	3056
	ROOF BOARDS - DACHBRETTER - VOLIGES 	250	90x18	2000
SV-1	TERRACE BOARDS - TERRASSENBRETTER - PLANCHER DE TERRASSE 	32	90x19	4300
FL-1	FLOOR FILLET-FUSSBODENLEISTE - CORNIERE DE FINITION DU PLANCHER 		18x18	22 m.
DPL-1	ROOFING FELT FILLET - DACHPAPPENLEISTE - BAGUETTE DE FIXATION DU FEUTRE BITUMEUX 	6	18x58	2050

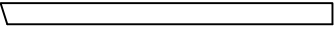
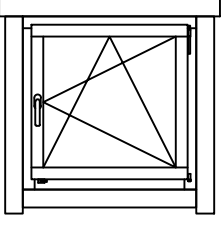
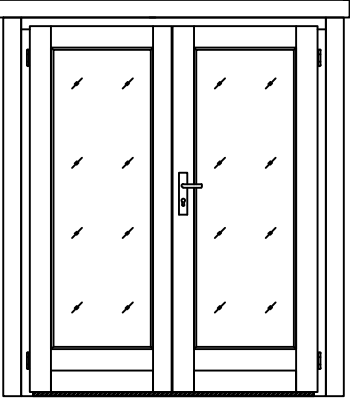
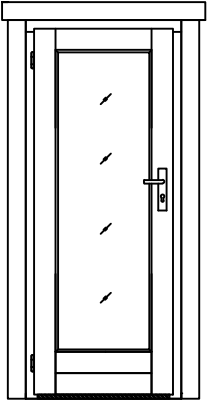
Pos	702741 - Orinoco Piece list - Stückliste - Liste des pieces	Q.	P (mm)	L (mm)
P-1	POST - PFOSTEN - POTEAU 	1	120x120	2077
TB-1	EAVES BOARD - TRAUFBRETT - BANDEAU DE TOIT 	1	18x90	1841
TB-2	EAVES BOARD - TRAUFBRETT - BANDEAU DE TOIT 	2	18x90	4341
TB-3	EAVES BOARD - TRAUFBRETT - BANDEAU DE TOIT 	1	18x90	5559
DRV-1	ROOF EDGE REINFORCEMENT - DACHRANDVERSTÄRKUNG - CORNIERE DE RENFORT DE BORD DE TOIT 	1	28x34	1841
DRV-2	ROOF EDGE REINFORCEMENT - DACHRANDVERSTÄRKUNG - CORNIERE DE RENFORT DE BORD DE TOIT 	2	28x34	4341
DRV-3	ROOF EDGE REINFORCEMENT - DACHRANDVERSTÄRKUNG - CORNIERE DE RENFORT DE BORD DE TOIT 	1	28x34	5559
GL-1	GABLE MOULDING - GIEBELLEISTE - PLANCHE DE RIVE 	6	18x120	2050
	WINDOW-FENSTER-FENETRE 916x916 2+ A.0P 	1		
	DOOR-TÜR-PORTE 1580x2000 2+ TU.10P 	1		
	DOOR-TÜR-PORTE 827x2000 2+ U.10V 	1		