

Jordan
Art.No. 702341

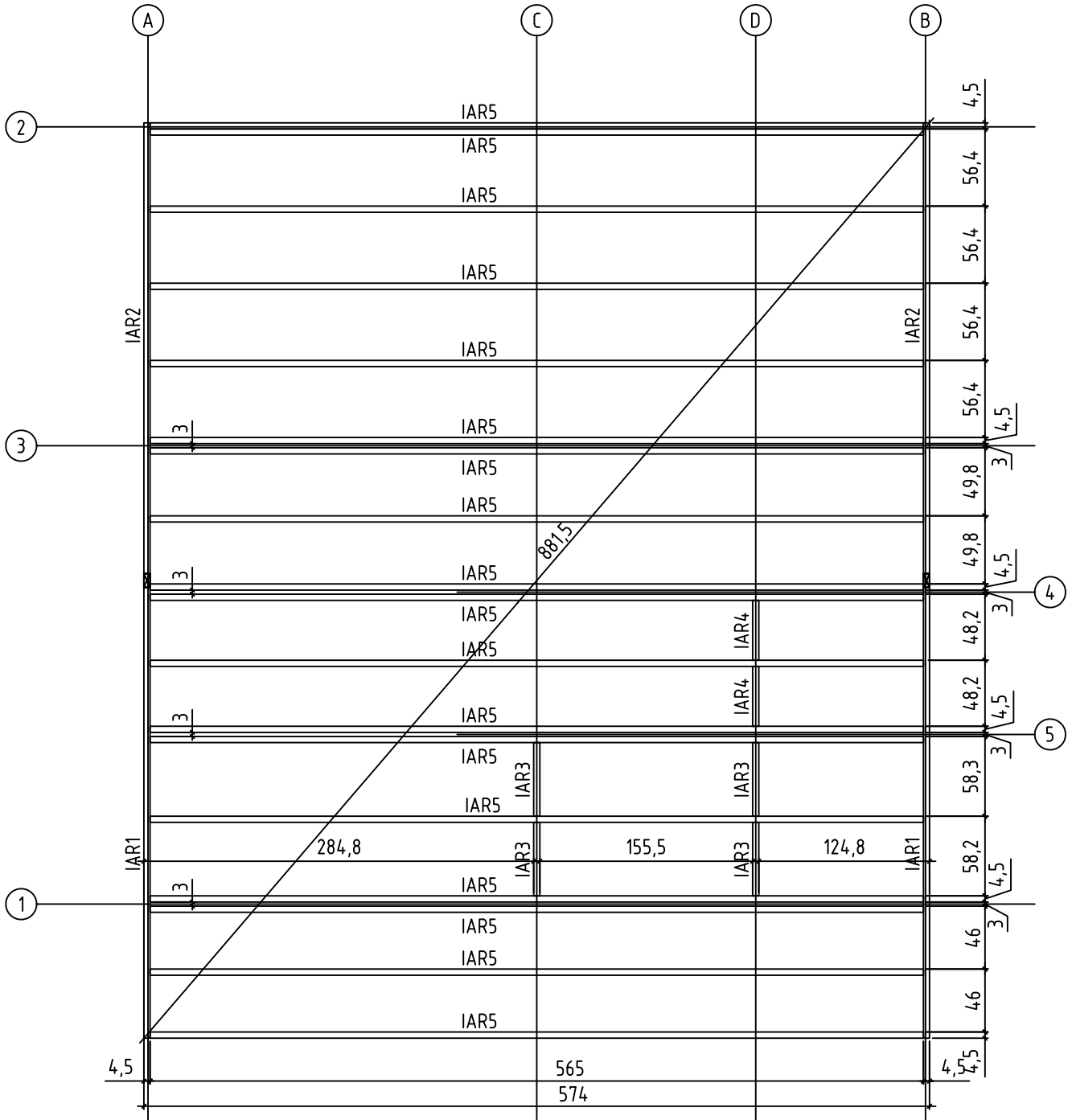

Jordan, Art.No.702341
 FOUNDATION - FUNDAMENT - FONDATION



Jordan, Art.No.702341
FLOOR BOARDS - FUSSBODENBRETTER - PLAN POSE PLANCHER

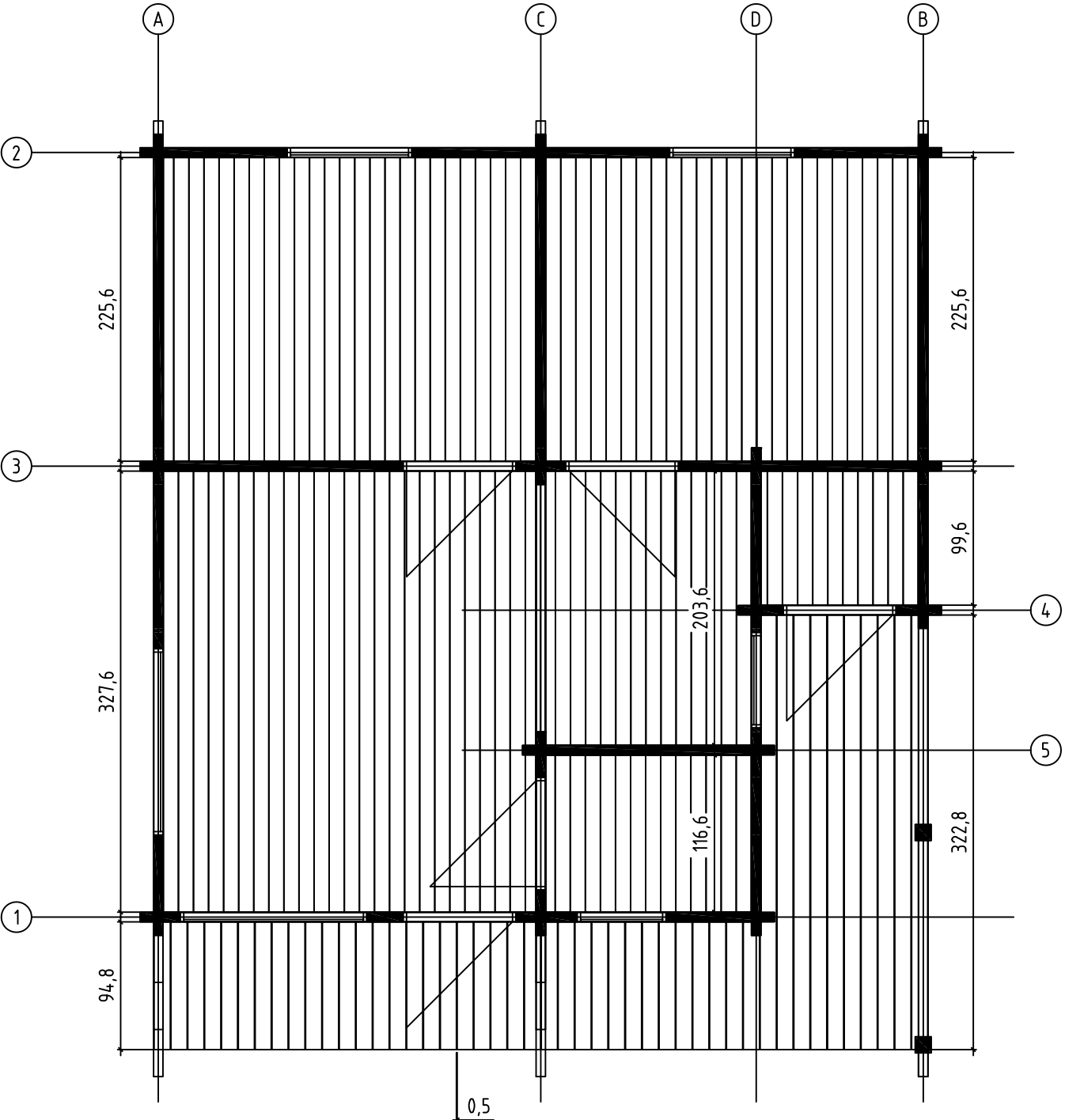

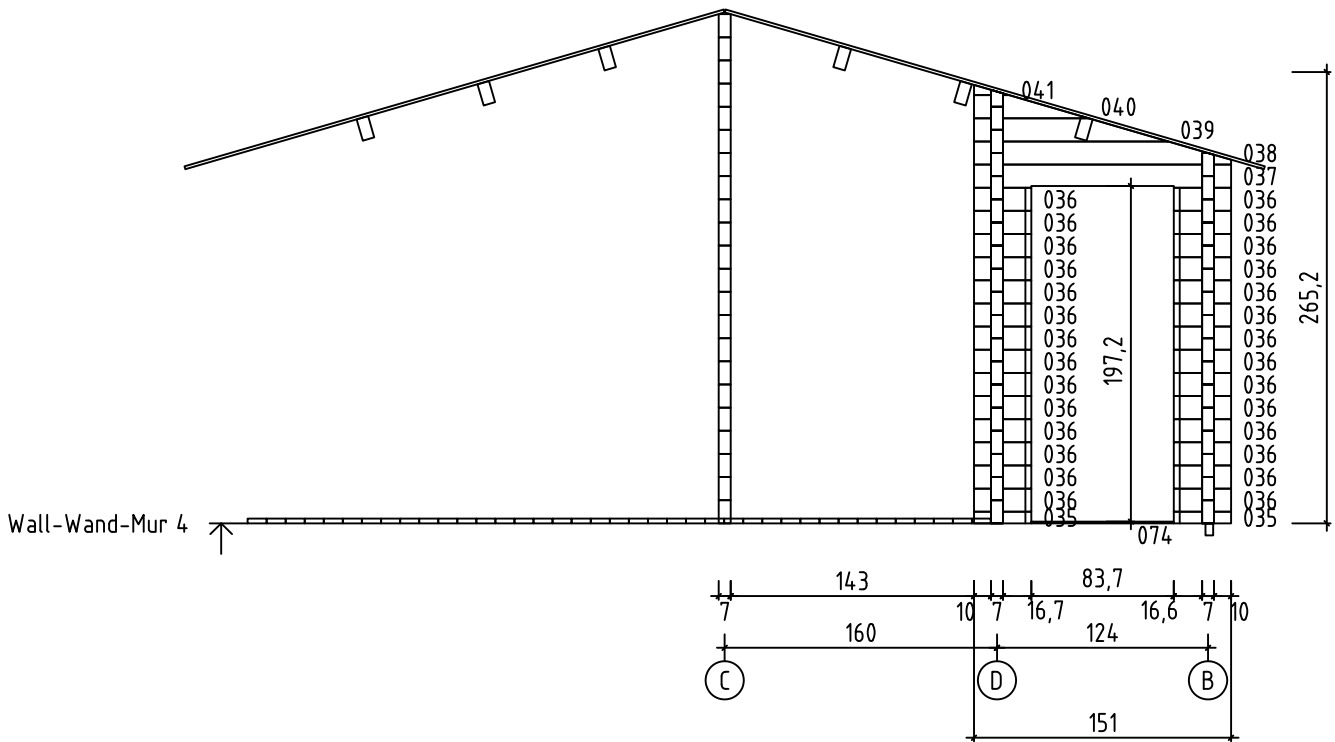
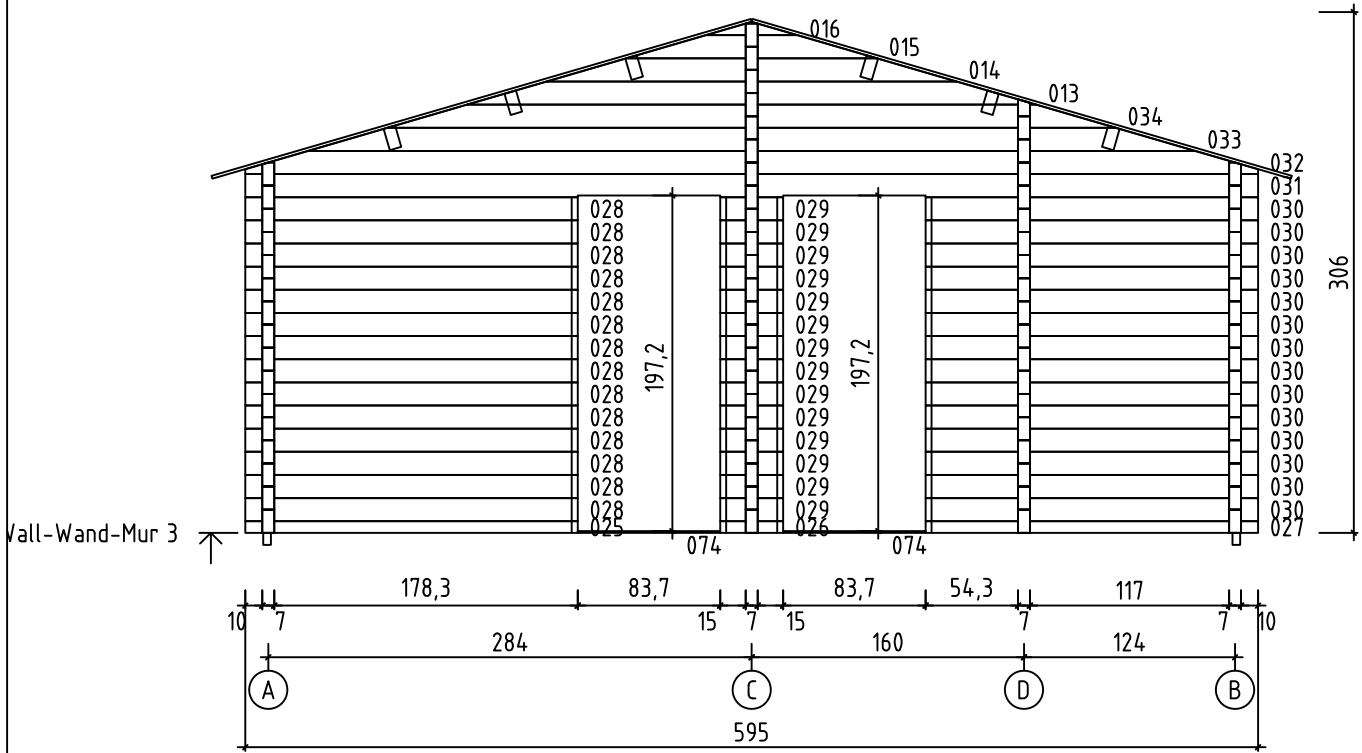

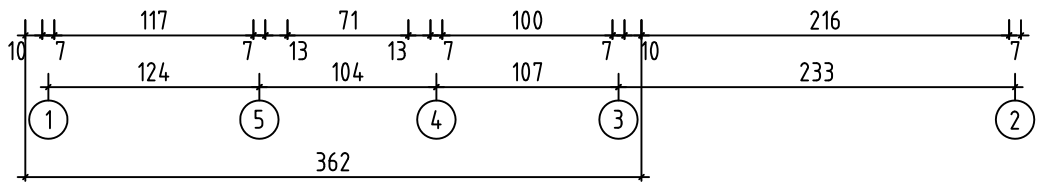
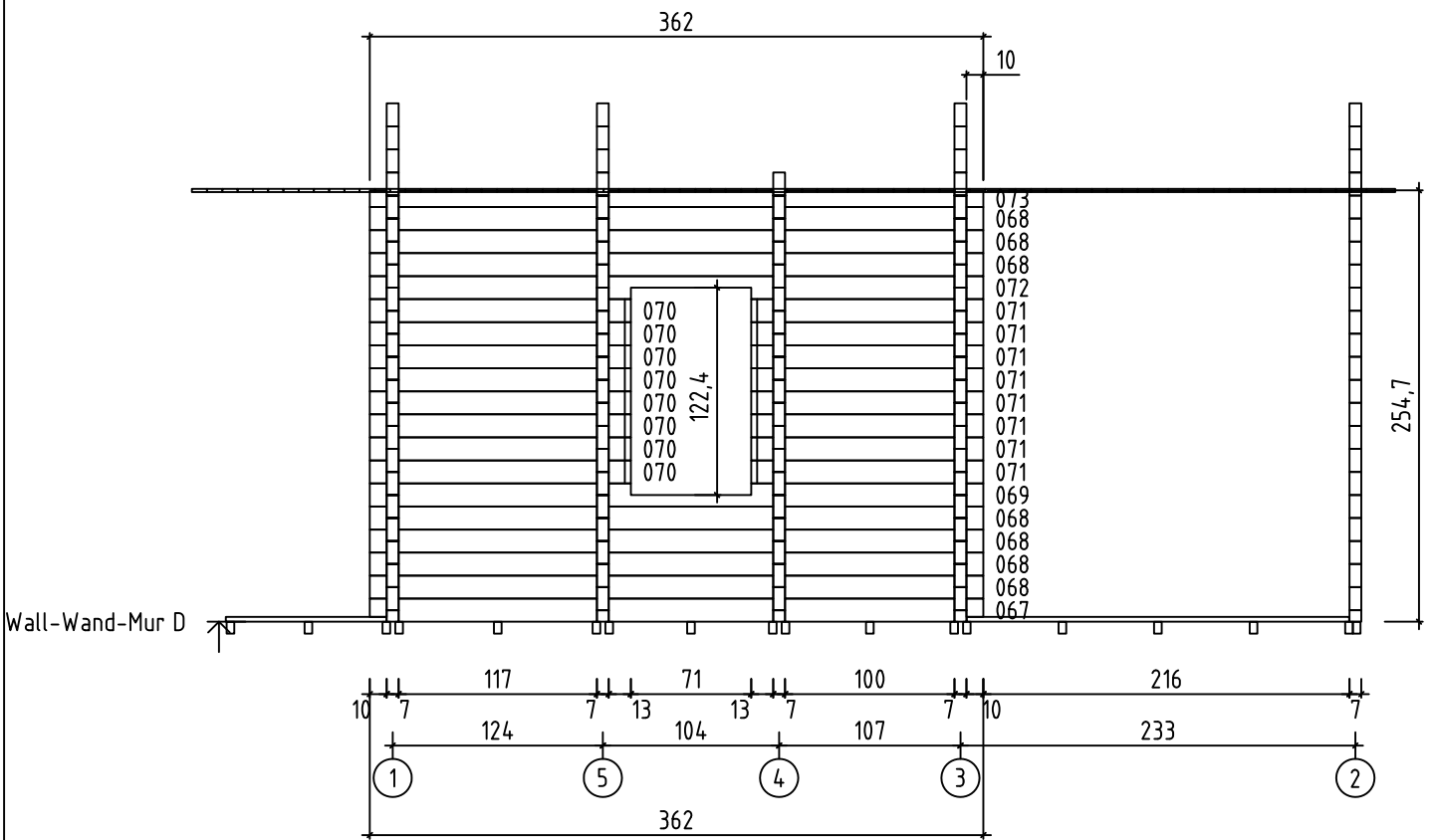
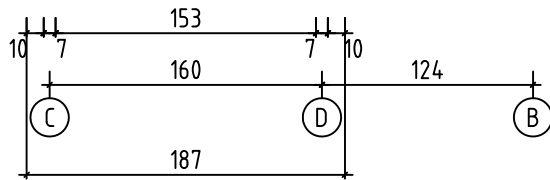
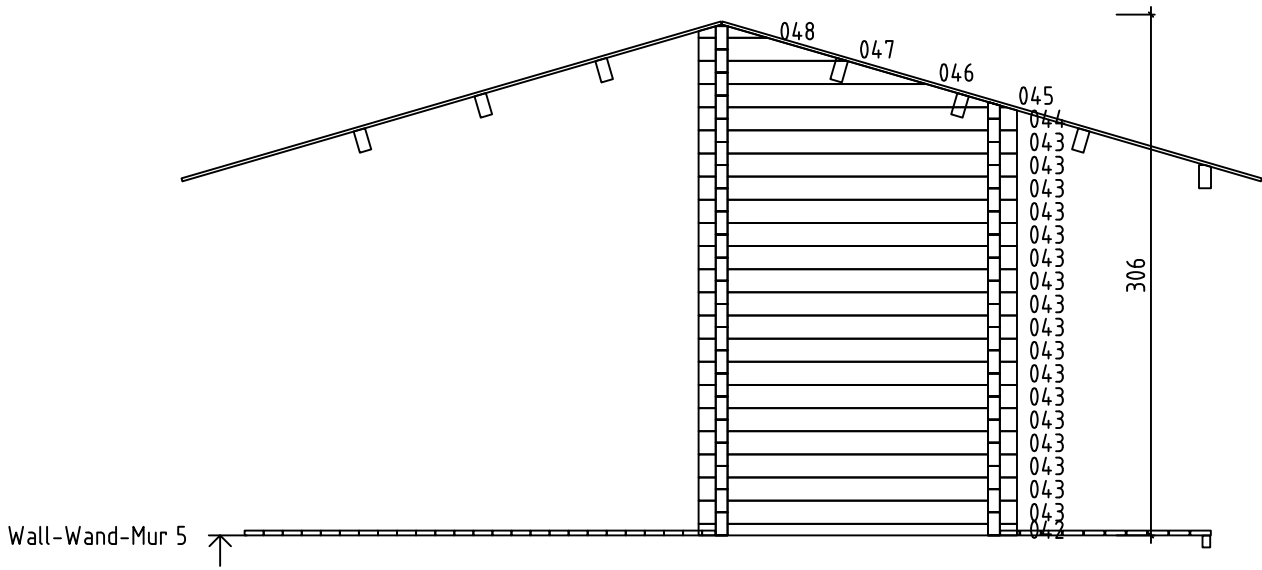



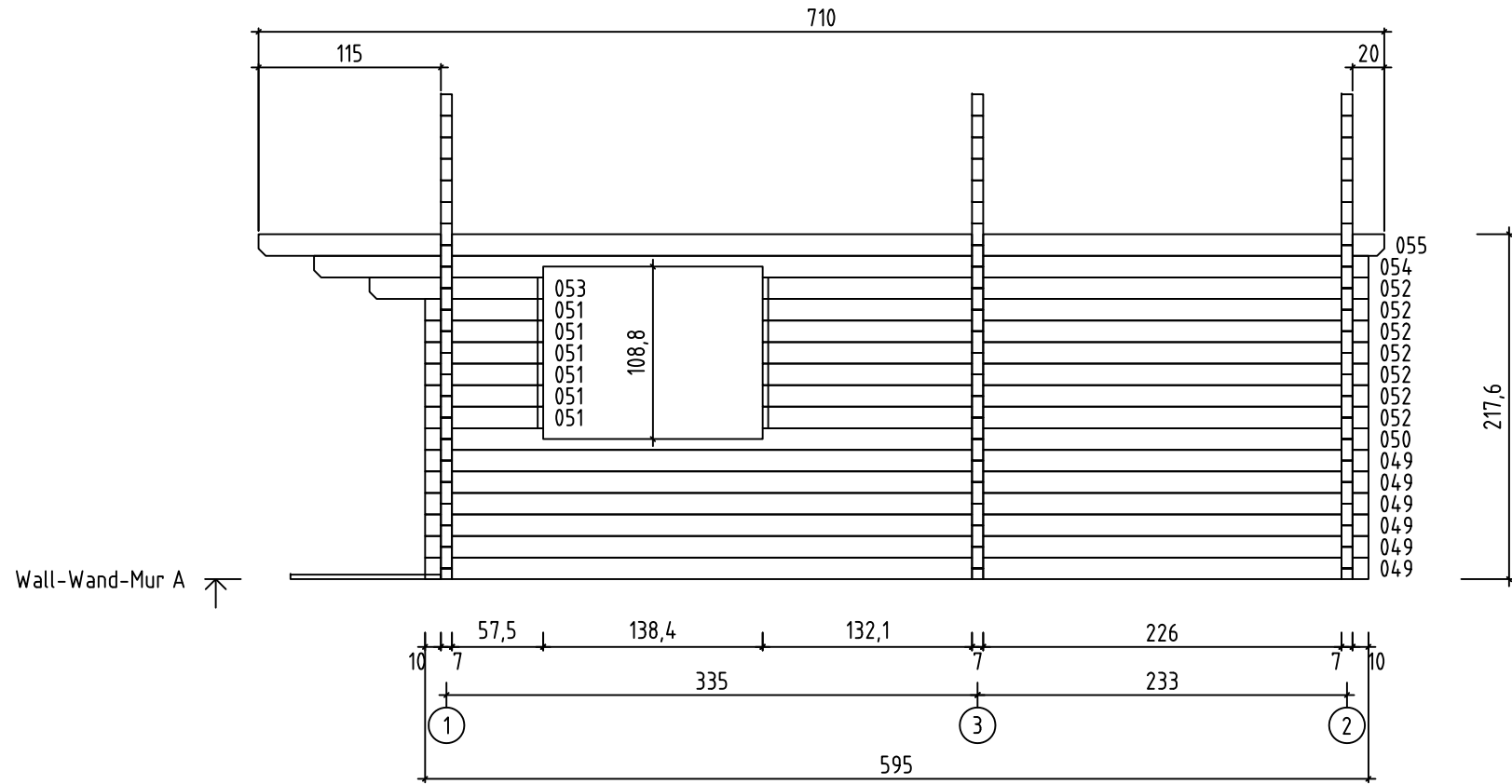

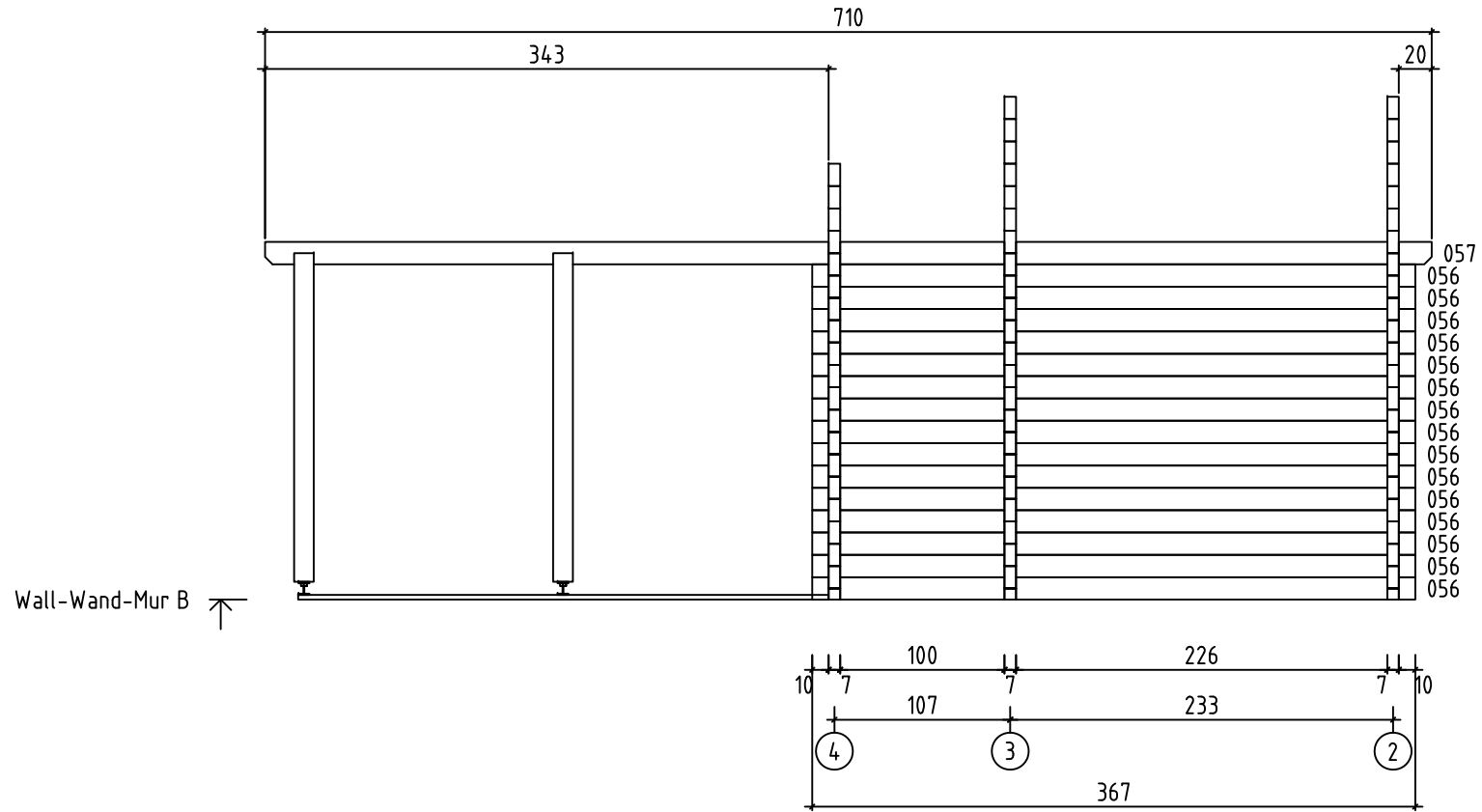



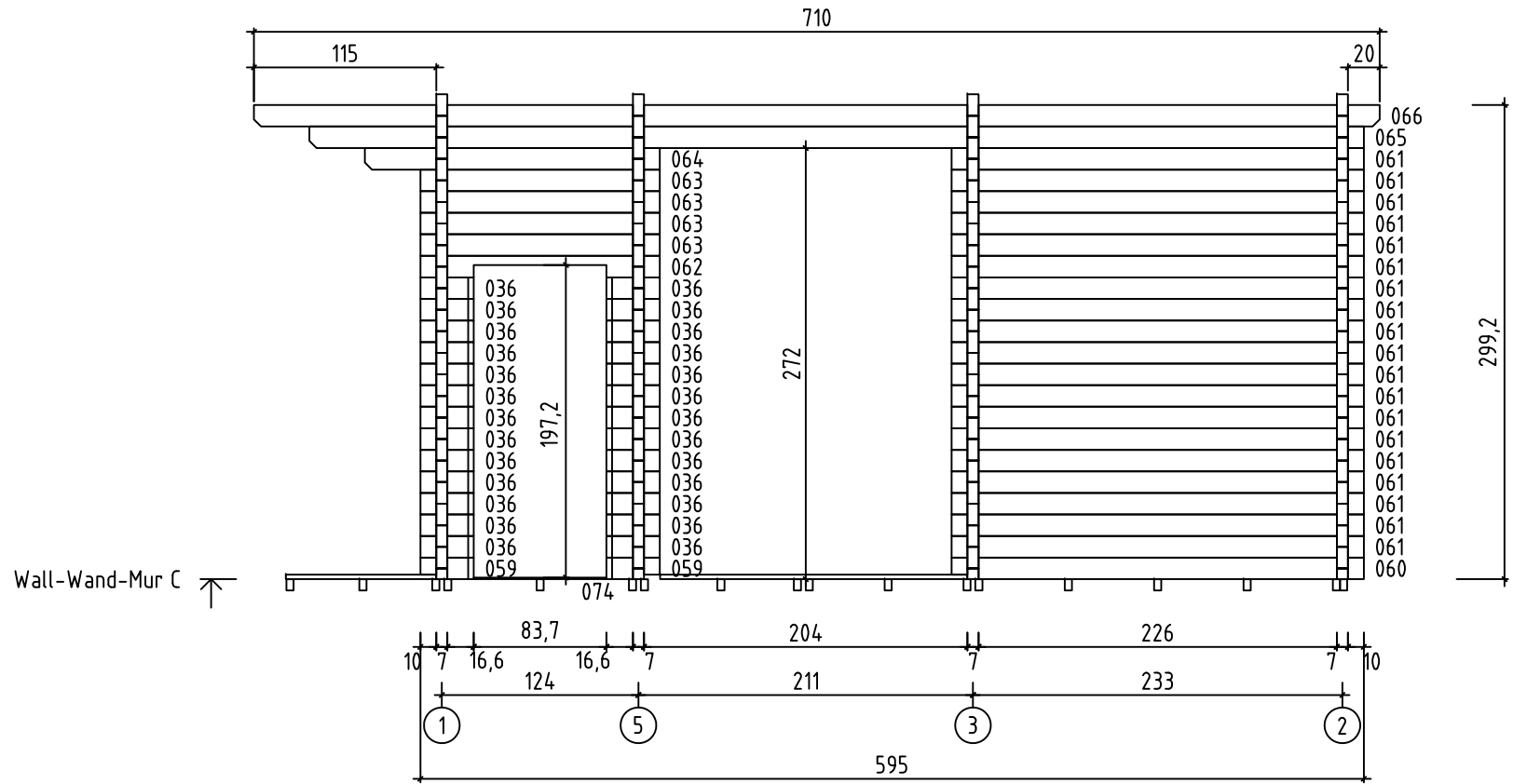

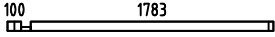
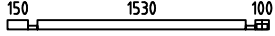
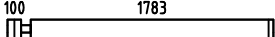
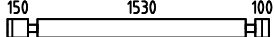

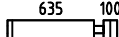
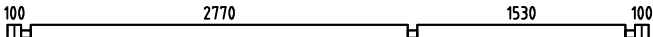
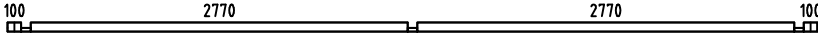
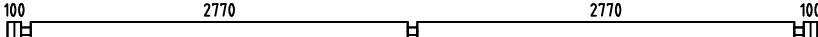
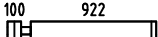
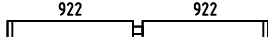

Jordan, Art.No.702341

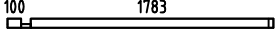

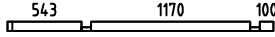
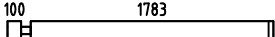

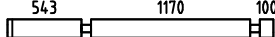



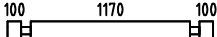

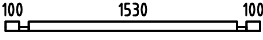
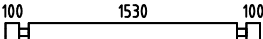
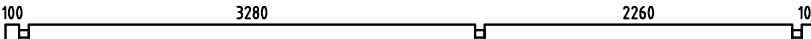
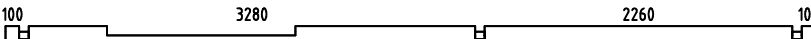
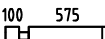
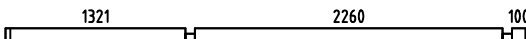
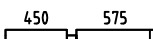
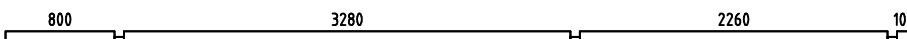
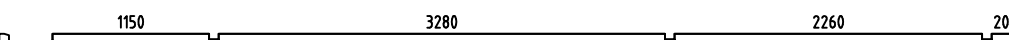

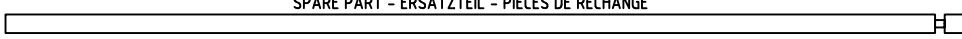

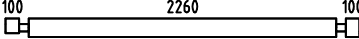
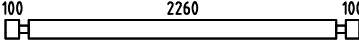
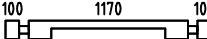
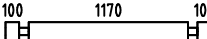
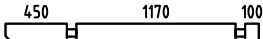
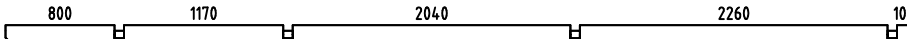
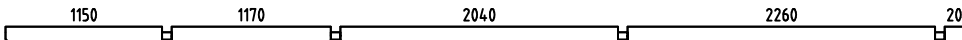
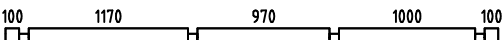
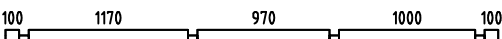
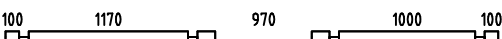
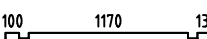
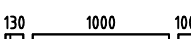







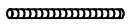
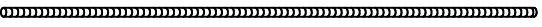

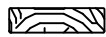

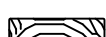
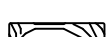
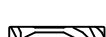
Jordan, Art.No.702341

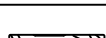
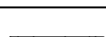
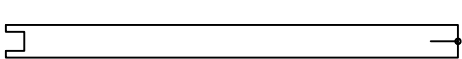
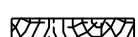

Pos	Jordan, Art.No.702341 Piece list - Stückliste - Liste des pieces	Q.	P (mm)	L (mm)
001		1	70x68	1953
002		1	70x68	1920
003		6	70x136	1953
004		9	70x136	1920
005		8	70x136	299
006		8	70x136	270
007		5	70x136	455
008		5	70x136	805
009		1	70x136	4710
017		1	70x68	5950
018		8	70x136	5950
019		14	70x136	1092
020		7	70x136	1914
025		1	70x136	270
026		1	70x136	270
027		1	70x68	1953
028		1	70x68	370
029		1	70x68	1953
030		14	70x136	1953
031		14	70x136	370
032		14	70x136	1953
033		1	70x136	5950
037		2	70x68	337
038		54	70x136	337
039		1	70x136	1510

Pos	Jordan, Art.No.702341 Piece list - Stückliste - Liste des pieces	Q.	P (mm)	L (mm)
044		1	70x68	1870
045		17	70x136	1870
051		6	70x136	5950
052		1	70x136	5950
053		6	70x136	745
054		7	70x136	3821
055		1	70x136	1095
056		1	70x136	6650
057		1	70x136	7100
058		15	70x136	3670
059		1	70x136	7100
060	SPARE PART - ERSATZTEIL - PIECES DE RECHANGE 	1	70x136	7100
061		2	70x136	336
062		1	70x136	2600
063		19	70x136	2600
064		1	70x136	1510
065		4	70x136	1510
066		1	70x136	1860
067		1	70x136	6650
068		1	70x136	7100
069		1	70x136	3620
070		7	70x136	3620
071		1	70x136	3620
072		8	70x136	1540
073		8	70x136	1370

Pos	Jordan, Art.No.702341 Piece list - Stückliste - Liste des pieces	Q.	P (mm)	L (mm)
074		1	70x136	3620
075		1	70x99	3620
076		5	70x10	837
W1-1		1		
W2-1		1		
W3-1		1		
W4-1		1		
W5-1		1		
IAR5	FOUNDATION - FUNDAMENT - FONDATION 	18	45x70	5650
IAR2	FOUNDATION - FUNDAMENT - FONDATION 	2	45x70	3395
IAR1	FOUNDATION - FUNDAMENT - FONDATION 	2	45x70	3395
IAR3	FOUNDATION - FUNDAMENT - FONDATION 	4	45x70	538
IAR4	FOUNDATION - FUNDAMENT - FONDATION 	2	45x70	438
A-PR3	ROOF BEAM - DACHBALKEN - PANNE DE TOIT 	1	70x140	7100
A-PR2	ROOF BEAM - DACHBALKEN - PANNE DE TOIT 	2	70x140	7100
A-PR1	ROOF BEAM - DACHBALKEN - PANNE DE TOIT 	3	70x140	7100
PTL	FLOOR BOARDS - FUSSBODENBRETTER - LAME DE PLANCHER 	25	112x28	3276
PTL	FLOOR BOARDS - FUSSBODENBRETTER - LAME DE PLANCHER 	50	112x28	2256
PTL	FLOOR BOARDS - FUSSBODENBRETTER - LAME DE PLANCHER 	14	112x28	2036
PTL	FLOOR BOARDS - FUSSBODENBRETTER - LAME DE PLANCHER 	14	112x28	1166
PTL	FLOOR BOARDS - FUSSBODENBRETTER - LAME DE PLANCHER 	11	112x28	996

Pos	Jordan, Art.No.702341 Piece list - Stückliste - Liste des pieces		Q.	P (mm)	L (mm)
SV2	TERRACE BOARDS - TERRASSENBRETT - PLANCHER DE TERRASSE		36	120x28	948
	FLOOR FILLET-FUSSBODENLEISTE - CORNIERE DE FINITION DU PLANCHER			15x40	45.3 m.
DPL	ROOFING FELT FILLET - DACHPAPPENLEISTE - BAGUETTE DE FIXATION DU FEUTRE BITUMEUX		4	18x58	3350
M12	TREADED ROD M12 - GEWINDESTANGE M12 - TIGE FILETÉE M12		3		180
M12	TREADED ROD M12 - GEWINDESTANGE M12 - TIGE FILETÉE M12		1		500
M12	TREADED ROD M12 - GEWINDESTANGE M12 TIGE FILETÉE M12		4		2000
LPL	FIXING FILLET - FIXIRUNGSLEISTE - PROFIL DE FIXATION		2	20x70	610
LPL	FIXING FILLET - FIXIRUNGSLEISTE - PROFIL DE FIXATION		2	20x70	650
LPL	FIXING FILLET - FIXIRUNGSLEISTE - PROFIL DE FIXATION		2	20x70	662
LPL	FIXING FILLET - FIXIRUNGSLEISTE - PROFIL DE FIXATION		5	20x70	787
LPL	FIXING FILLET - FIXIRUNGSLEISTE - PROFIL DE FIXATION		4	20x70	876
LPL	FIXING FILLET - FIXIRUNGSLEISTE - PROFIL DE FIXATION		4	20x70	916
LPL	FIXING FILLET - FIXIRUNGSLEISTE - PROFIL DE FIXATION		4	20x70	1050
LPL	FIXING FILLET - FIXIRUNGSLEISTE - PROFIL DE FIXATION		2	20x70	1190
LPL	FIXING FILLET - FIXIRUNGSLEISTE - PROFIL DE FIXATION		4	20x70	1334
LPL	FIXING FILLET - FIXIRUNGSLEISTE - PROFIL DE FIXATION		10	20x70	1933
P	POST - PFOSTEN - POTEAU		2	120x120	2000
TB	EAVES BOARD - TRAUFBRETT - BANDEAU DE TOIT		4	18x90	3550
DRV	ROOF EDGE REINFORCEMENT - DACHRANDVERSTÄRKUNG - CORNIERE DE RENFORT DE BORD DE TOIT		4	28x34	3550
TBE6	FIXING FILLET FOR WINDOW - FIXIRUNGSLEISTE FÜR FENSTER - PROFIL DE FIXATION DES FENETRES		2	28x34	650
TBE6	FIXING FILLET FOR WINDOW - FIXIRUNGSLEISTE FÜR FENSTER - PROFIL DE FIXATION DES FENETRES		2	28x34	884
TBE6	FIXING FILLET FOR WINDOW - FIXIRUNGSLEISTE FÜR FENSTER - PROFIL DE FIXATION DES FENETRES		4	28x34	916
TBE6	FIXING FILLET FOR WINDOW - FIXIRUNGSLEISTE FÜR FENSTER - PROFIL DE FIXATION DES FENETRES		2	28x34	1020
TBE6	FIXING FILLET FOR WINDOW - FIXIRUNGSLEISTE FÜR FENSTER - PROFIL DE FIXATION DES FENETRES		2	28x34	1050
TBE6	FIXING FILLET FOR DOOR - FIXIRUNGSLEISTE FÜR TÜR - PROFIL DE FIXATION DES PORTES		2	28x34	1826

Pos	Jordan, Art.No.702341 Piece list - Stückliste - Liste des pieces	Q.	P (mm)	L (mm)
TBE6	FIXING FILLET FOR DOOR - FIXIRUNGSLEISTE FÜR TÜR - PROFIL DE FIXATION DES PORTES 	8	28x34	1933
GL	GABLE MOULDING - GIEBELLEISTE - PLANCHE DE RIVE 	4	18x120	3350
KL4	LENGTHENING BOLT FOR TREADED ROD - VERLÄNGERUNGSMUTTER FÜR GEWINDESTANGE - MANCHON DE RACCORDEMENT DE TIGE FILETÉE 	4		
KL1	DRIVE NUT TREADED ROD - EINSHLAGMUTTER FÜR GEWINDESTANGE - ÉCROU A FRAPPER POUR TIGE FILITÉE 	4		
KL2	NUT FOR TREADED ROD - MUTTER FÜR GEWINDESTANGE - ÉCROU POUR TIGE FILETÉE 	4		
KL3	PLAIN WASHER TREADED ROD - UNTERLEGSSCHEIBE FÜR GEWINDESTANGE - RONDELLE PLATE POUR TIGE FILETÉE 	4		
HS12	SCREW FOR GABLE SEGMENT - SCHRAUBEN FÜR DECKBLATT - VIS POUR FIXATION LOSANGE DE FINITION 	4	3.5x35	
HS83	SCREW FOR FIXING FILLET - SCHRAUBEN FÜR FIXIRUNGSLEISTE - VIS POUR PROFIL DE FIXATION 	162	3.5x50	
HS84	SCREW FOR FIXING FILLET - SCHRAUBEN FÜR FIXIRUNGSLEISTE - VIS POUR PROFIL DE FIXATION 	96	3.5x50	
HS16	SCREW FOR GABLE MOULDING - SCHRAUBEN FÜR GIEBELLEISTE - VIS DE FIXATION POUR PLANCHE DE RIVE 	40	3.5x50	
HS32	SCREW FOR EAVES BOARDS - SCHRAUBEN FÜR TRAUFBRETT - VIS DE FIXATION POUR BANDEAU DE TOIT 	32	4x40	
HS26	SCREW FOR ROOF EDGE REINFORCEMENT - SCHRAUBEN FÜR DACHRANDVERSTÄRKUNG - VIS POUR RENFORT DE BORD DE TOIT 	32	4x40	
HS34	SCREW FOR POST - SCHRAUBEN FÜR PFOSTEN - VIS DE FIXATION DES POTEAUX 	4	4x60	
HS17	SCREW FOR FLOOR BOARDS - SCHRAUBEN FÜR FUSSBODENBRETT - VIS D'ASSEMBLAGE DES LAMES DE PLANCHER 	660	4x60	
HS42	SCREW FOR GABLE - SCHRAUBEN FÜR GIEBEL - VIS POUR FIXATION DES PIGNONS 	48	5x120	
HS43	SCREW FOR ROOF BEAMS - SCHRAUBEN FÜR DACHBALKEN - VIS POUR PANNE DE TOIT 	20	5x120	
HS39	SCREW FOR FUNDAMENT - SCHRAUBEN ZUR BEFESTIGUNG FUNDAMENT - VIS POUR FONDATION 	91	5x90	
HS49	SCREW FOR POST HEIGHT ADJUSTMENT - SCHRAUBEN FÜR REGULIERUNGSSCHRAUBE FÜR PFOSTEN - VIS DE FIXATION DE SUPPORT RÉGLABLE DE POTEAU 	16	6x50	
MS	SCREW FOR DOORSTEP - SCHRAUBEN FÜR TÜRSCHWELLE - VIS DE FIXATION DU SEUIL DE PORTE 	10	4.5x65	
NF3	SCREW FOR TERRACE BOARD - SCHRAUBE FÜR TERRASSENBRETT - VIS POUR LAME DE SEUIL D'ENTREE DE TERRASSE 	360	4.2x55	
SH70	HAMMER BLOCK - SCHLAGHOLZ - CALLE DE FRAPPE 	2		
NFD	ZN NAIL FOR ROOFING FELT FILLET - ZN NÄGEL FÜR DACHPAPPENLEISTE - POINTE POUR BAGUETTE FIXATION FEUTRE BITUMEUX 	32	2x40	
NFF	ZN NAIL FOR FLOOR FILLETS - ZN NÄGEL FÜR FUSSBODENLEISTEN - POINTE POUR PANNEAUX DE PLANCHER 	90	1.4x40	
NF2	ZN NAIL FOR ROOF - ZN NÄGEL FÜR DACHBRETT - POINTE POUR TOIT 	830	2x50	
RFP	POST HEIGHT ADJUSTMENT - REGULIERUNGSSCHRAUBE FÜR PFOSTEN - SUPPORT RÉGLABLE DE POTEAU	2		

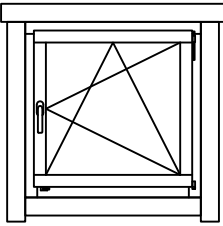
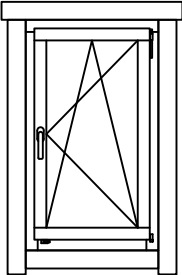
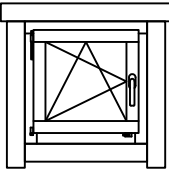
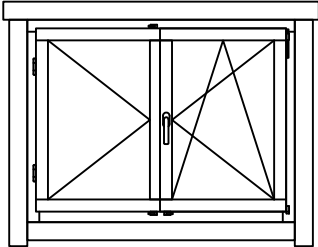
Pos	Jordan, Art.No.702341 Piece list - Stückliste - Liste des pieces	Q.	P (mm)	L (mm)
GS	GABLE SEGMENT-DECKBLATT - LOSANGE DE FINITION 	2		
ORZ	MONTAGE SET FOR DOORS AND WINDOWS - MONTAGE-SET FÜR TÜREN UND FENSTER - JEU DE MONTAGE PORTES ET FENETRES	1		
2+ A.0P	WINDOW-FENSTER-FENETRE 916x916 	2		
2+ A .0P.d	WINDOW-FENSTER-FENETRE 702x1190 	1		
2+ A .0V.c	WINDOW-FENSTER-FENETRE 650x650 	1		
2+ TA .0P.a	WINDOW-FENSTER-FENETRE 1374x1050 	2		

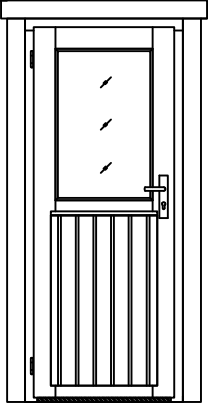
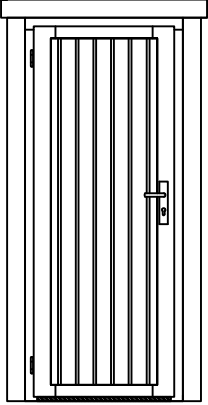
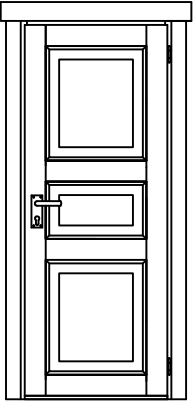
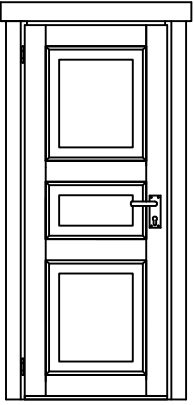
Pos	Jordan, Art.No.702341 Piece list - Stückliste - Liste des pieces	Q.	P (mm)	L (mm)
2+ U .20V	DOOR-TÜR-PORTE 827x1933 	1		
2+ U .2LV	DOOR-TÜR-PORTE 827x1933 	1		
U.3TP	DOOR-TÜR-PORTE 827x1933 	2		
U.3TV	DOOR-TÜR-PORTE 827x1933 	1		

