

*Indus 70*  
Art.No. 702141

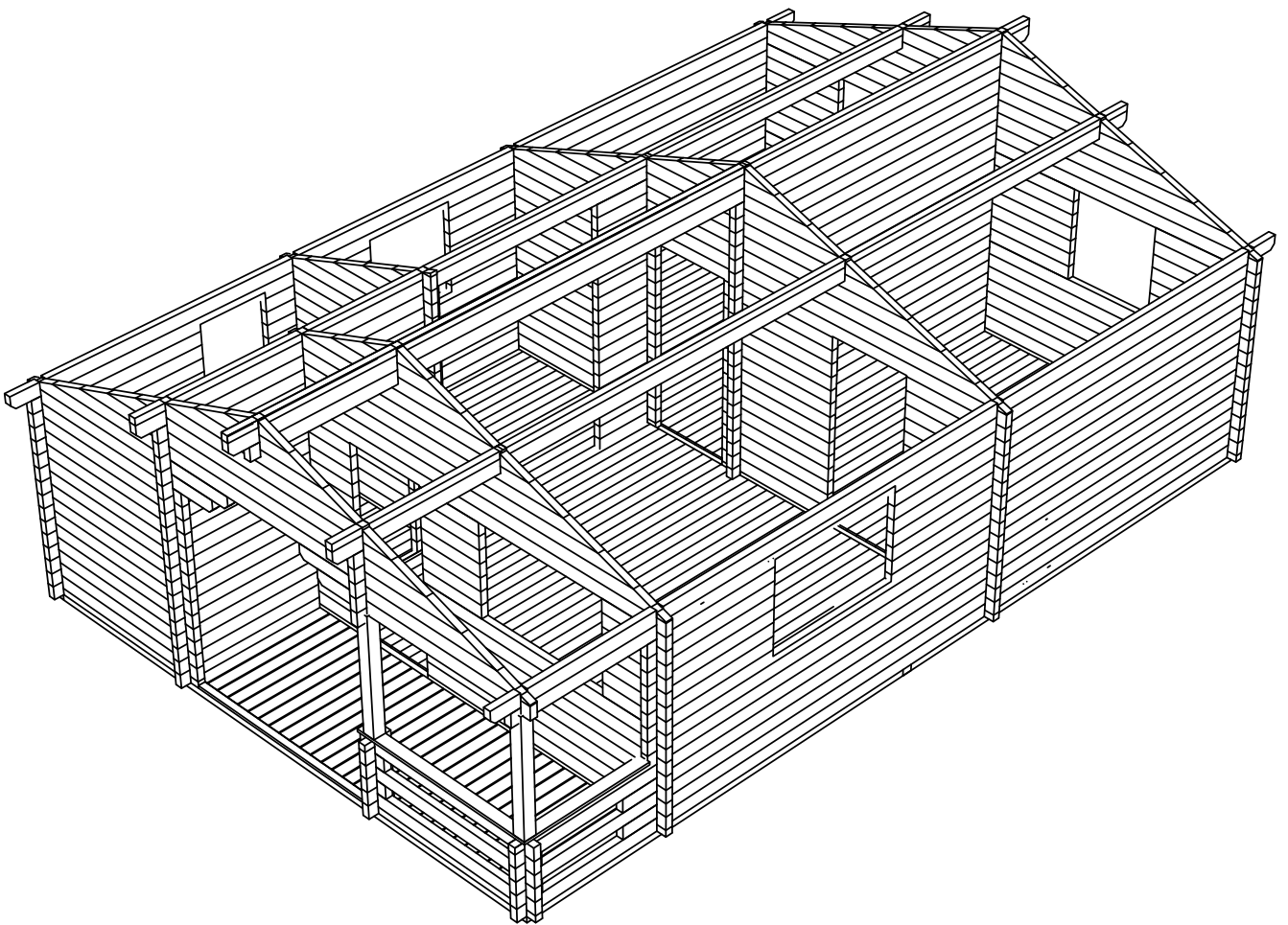

Indus 70, Art.No.702141  
GROUNDPLAN - GRUNDPLAN - PLAN DE MASSE

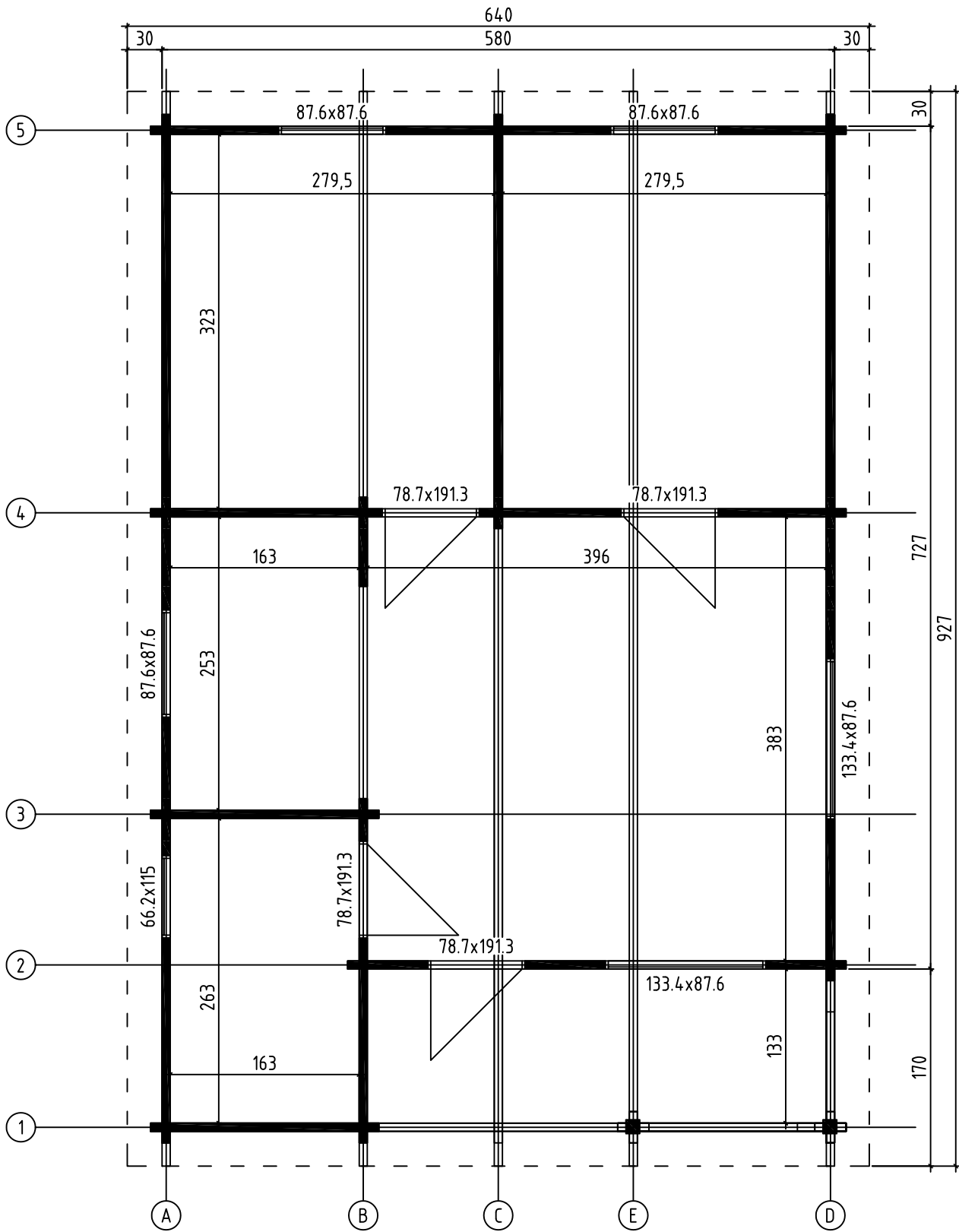

Indus 70, Art.No.702141  
 FOUNDATION - FUNDAMENT - FONDATION

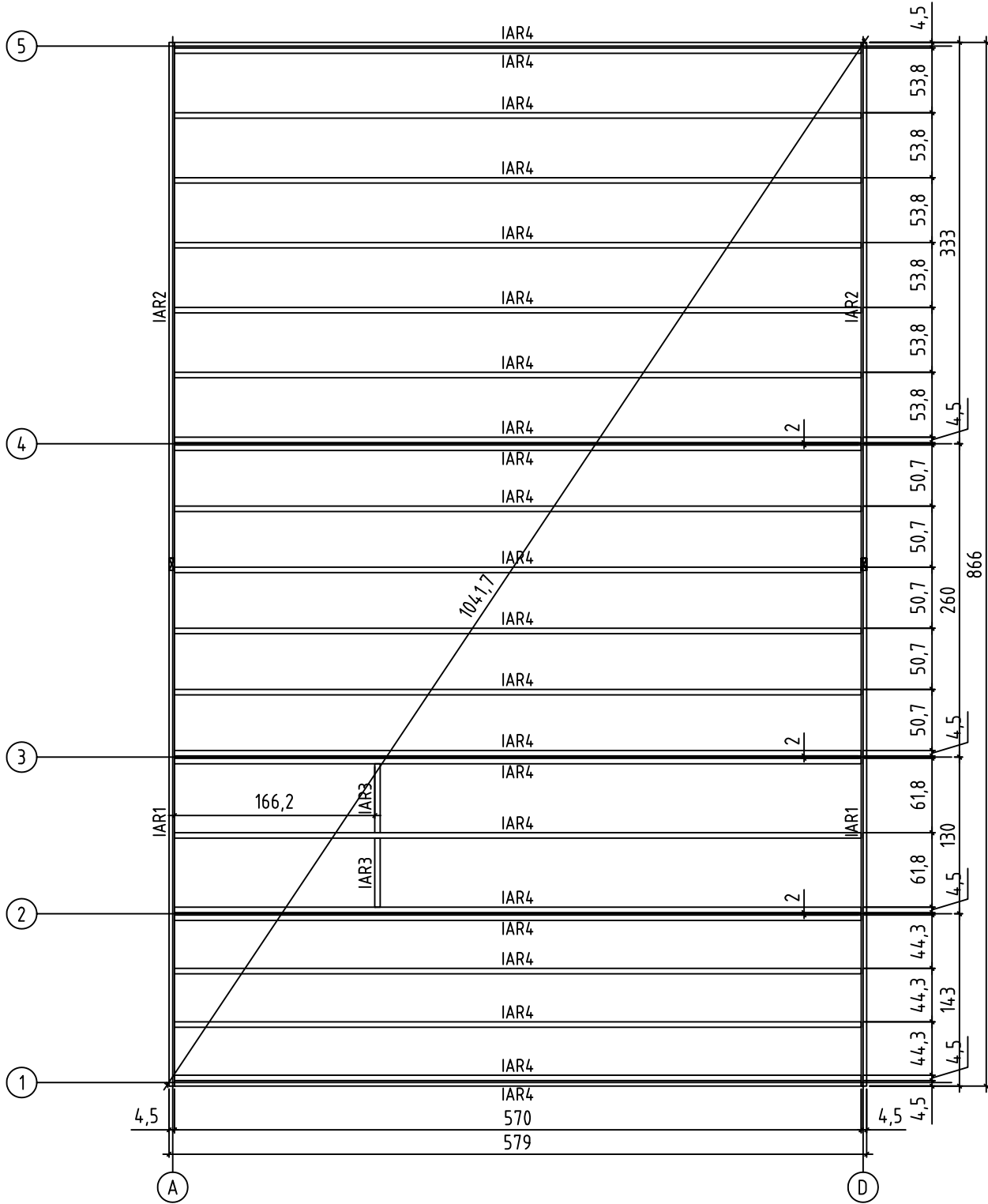

Indus 70, Art.No.702141  
FLOOR BOARDS - FUSSBODENBRETTER - PLAN POSE PLANCHER

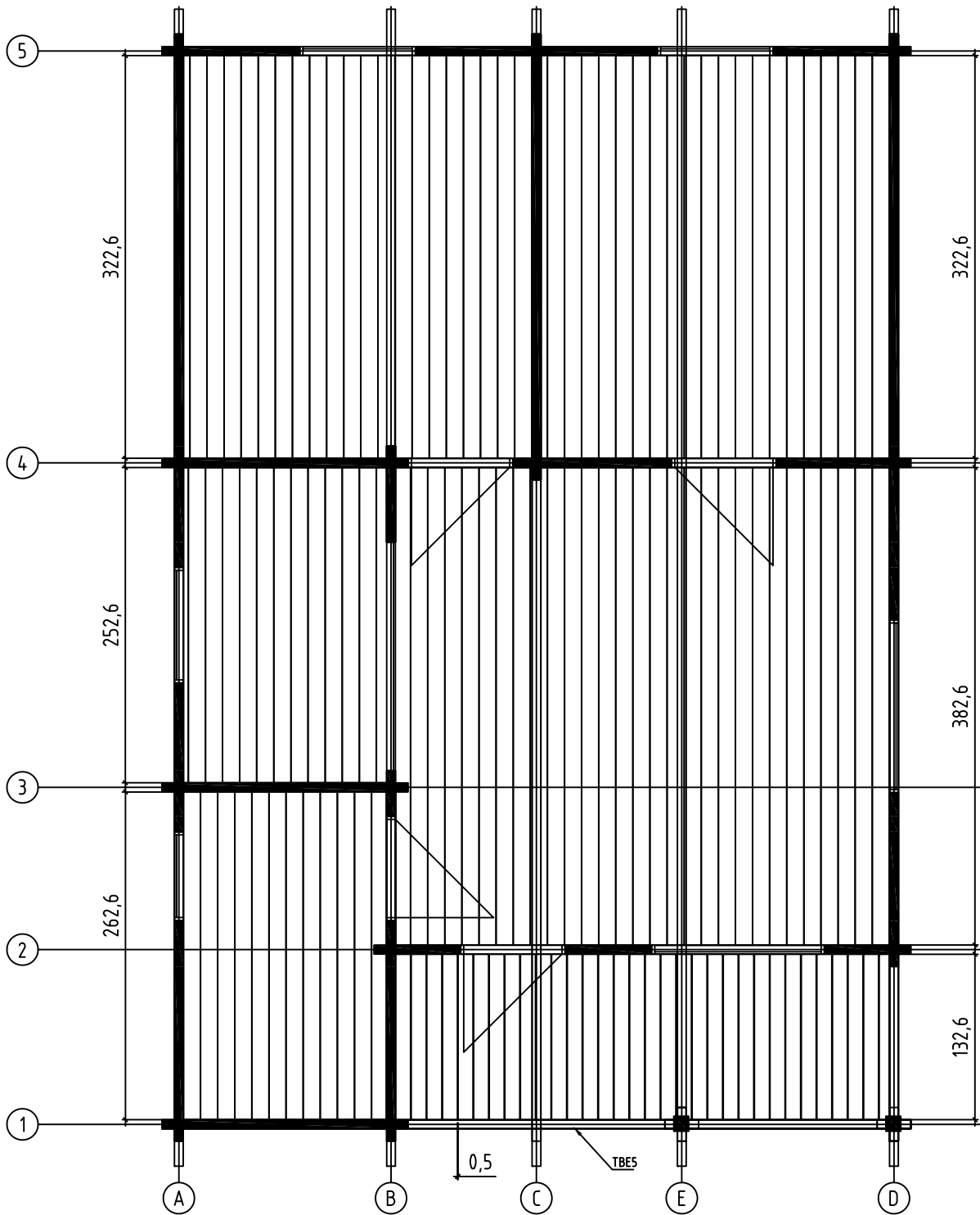

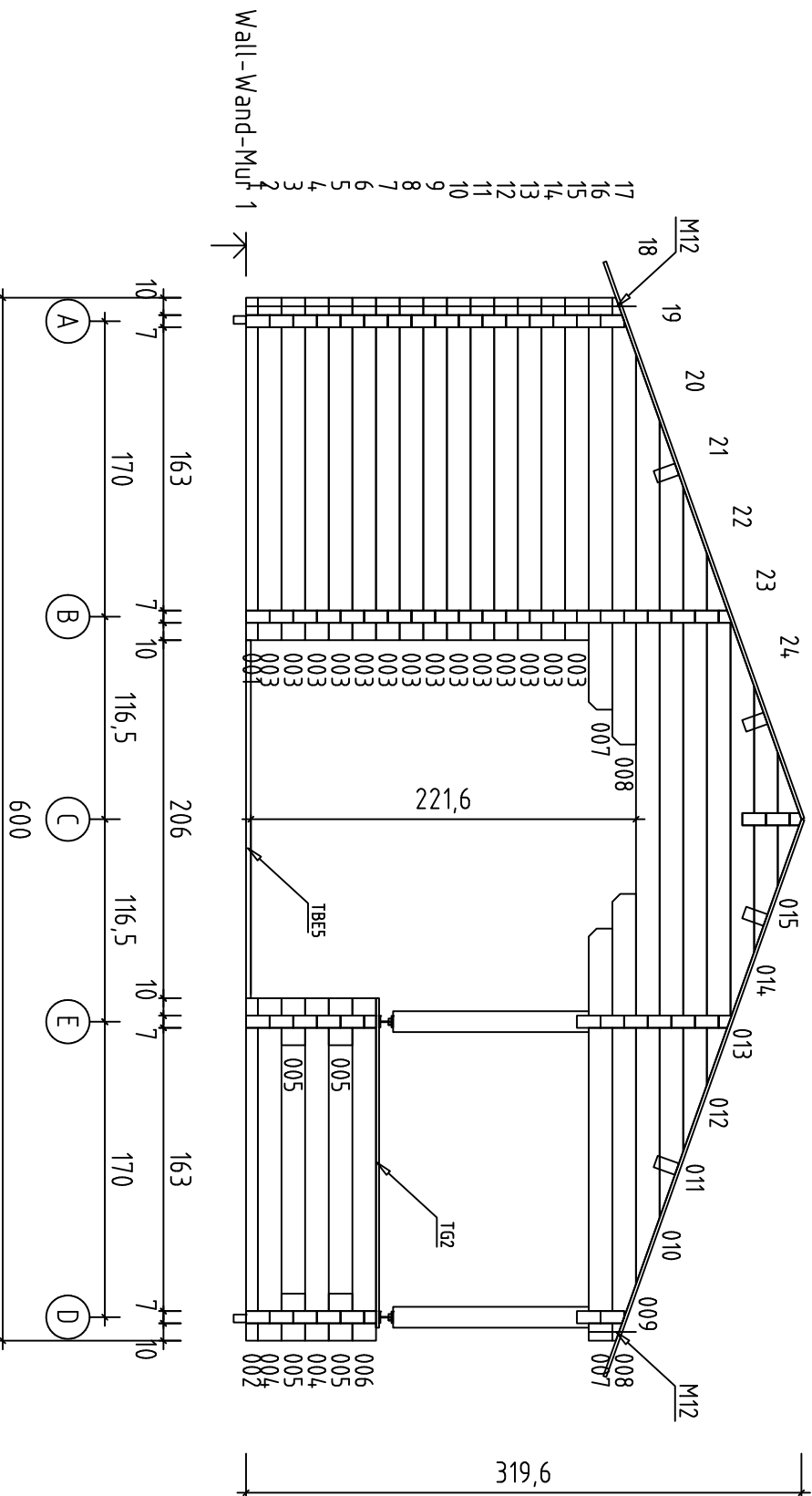

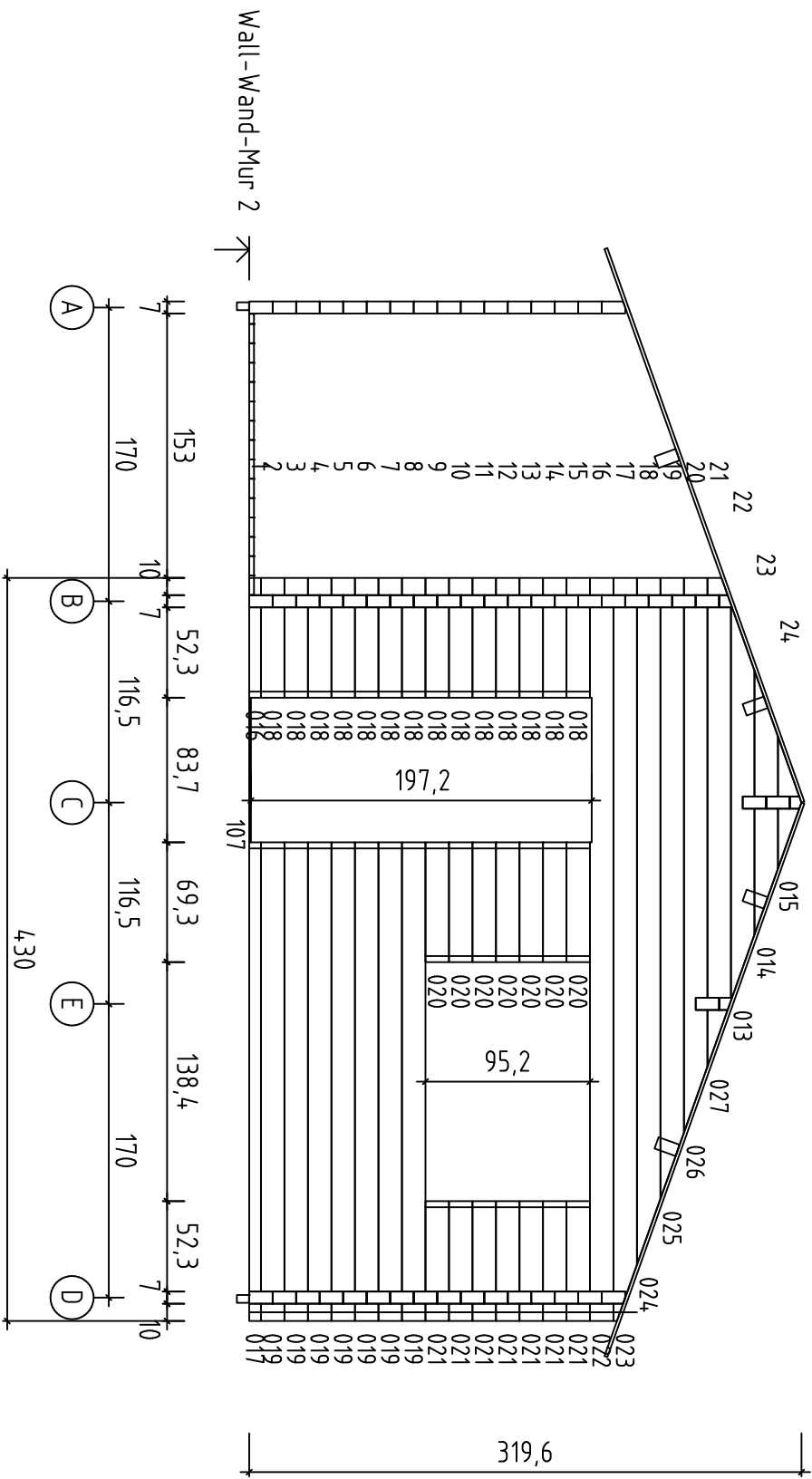

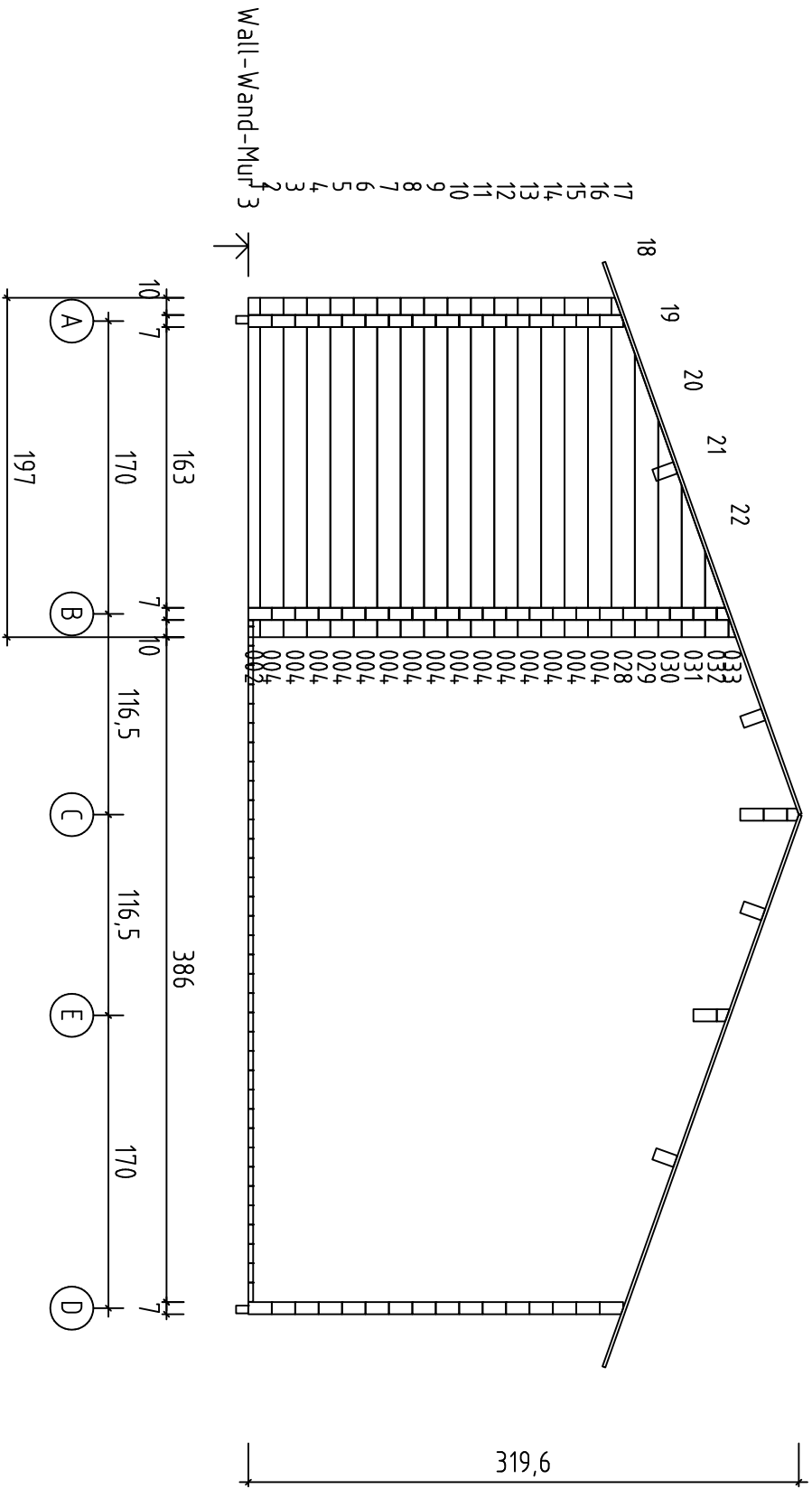

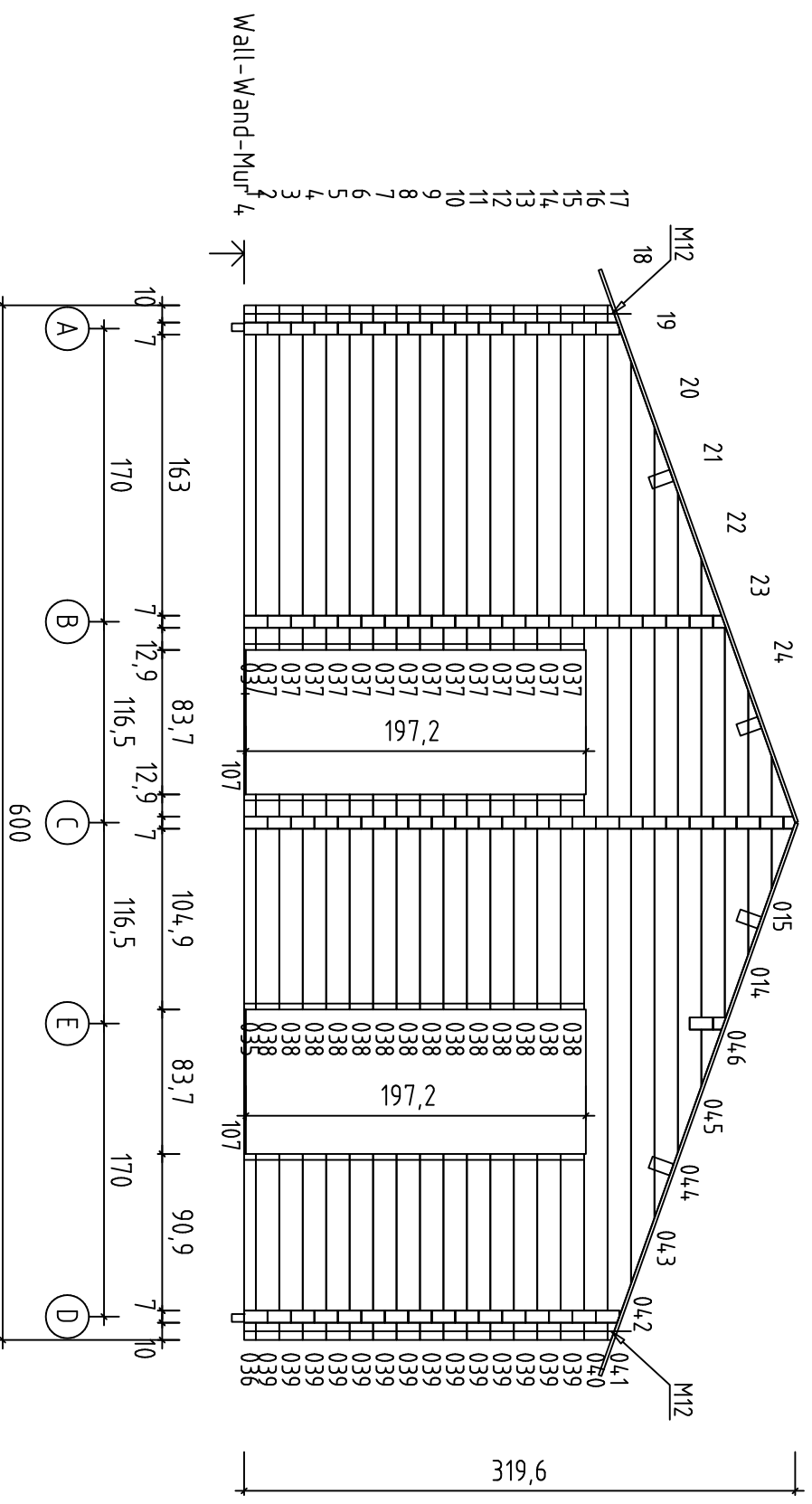



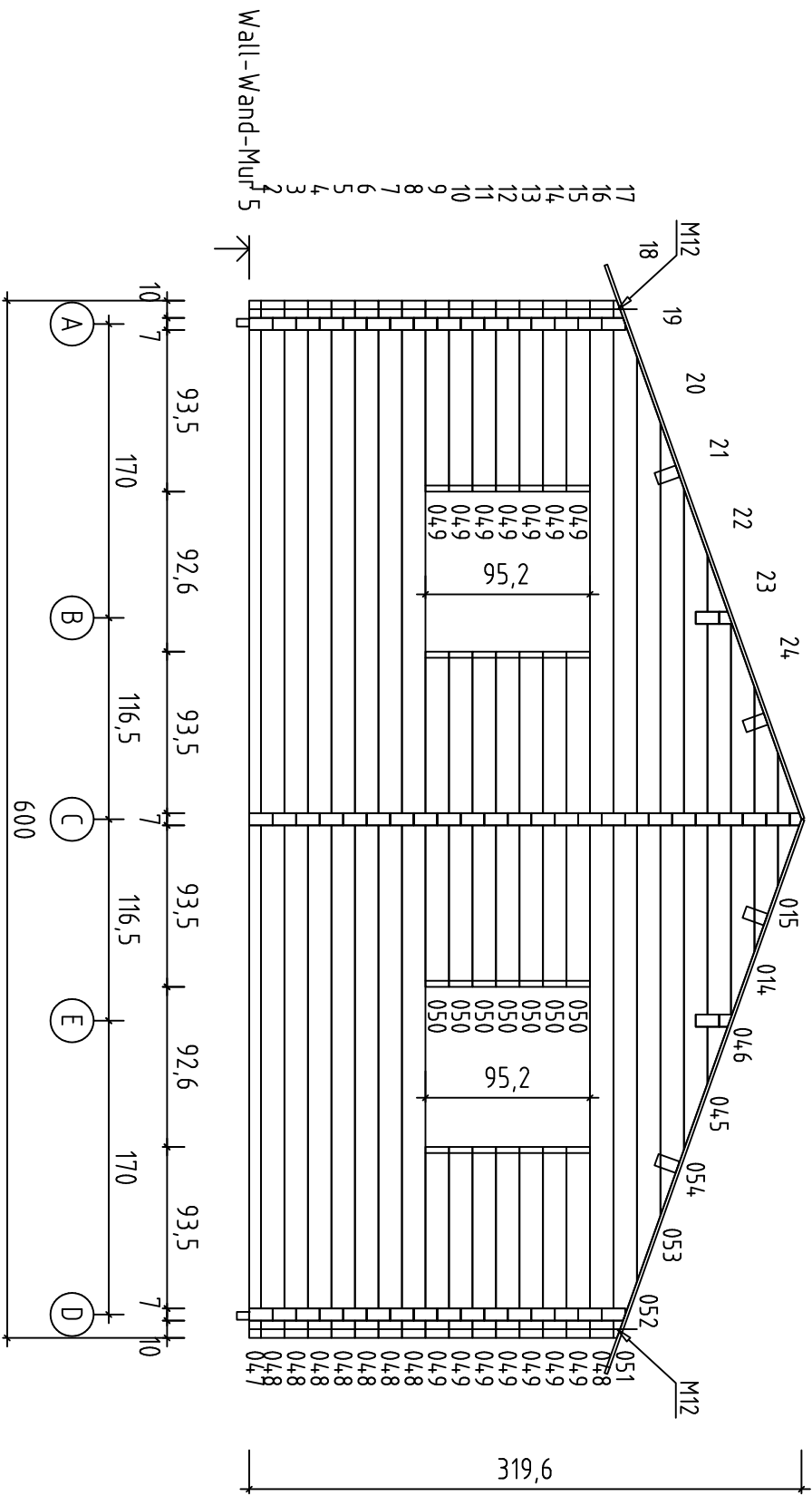

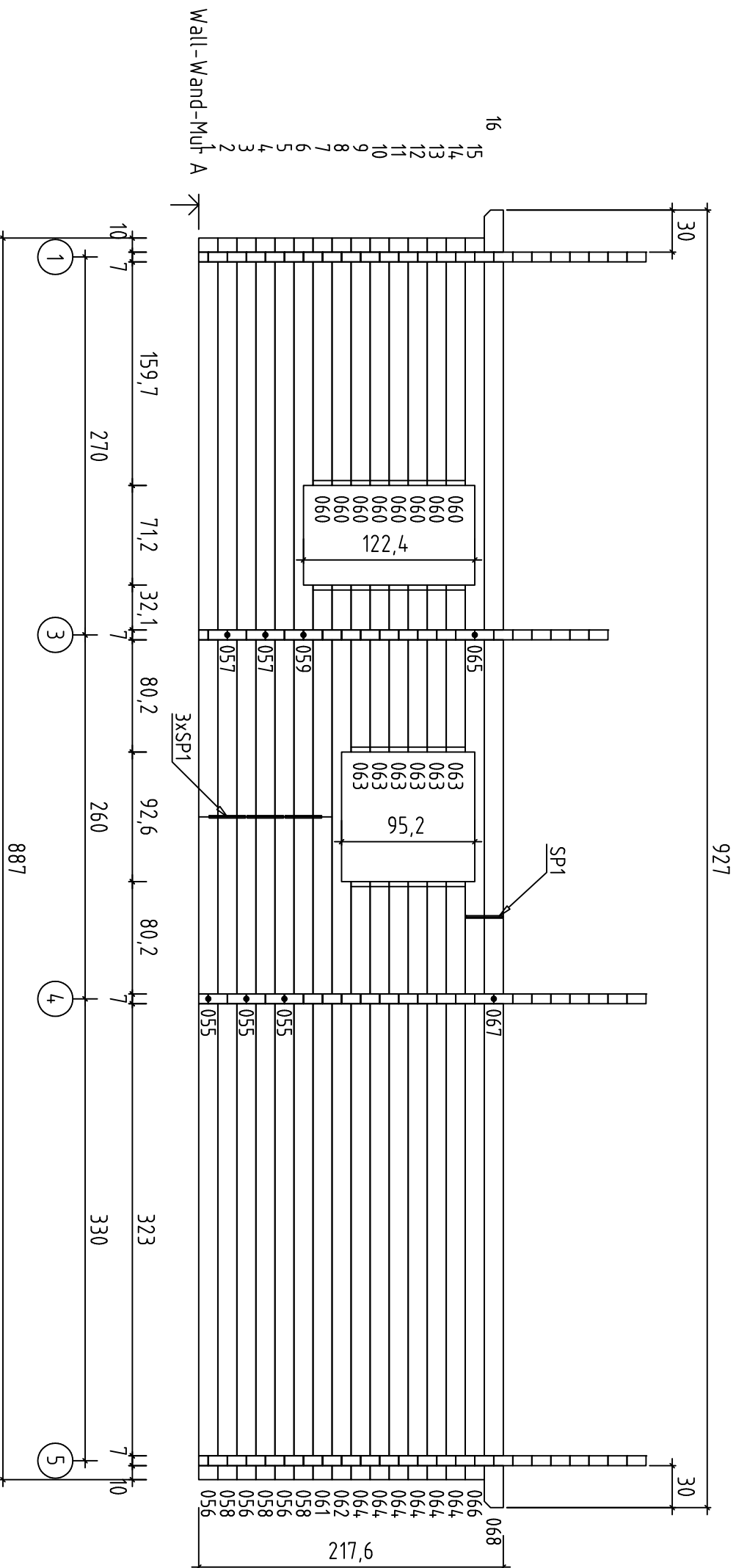

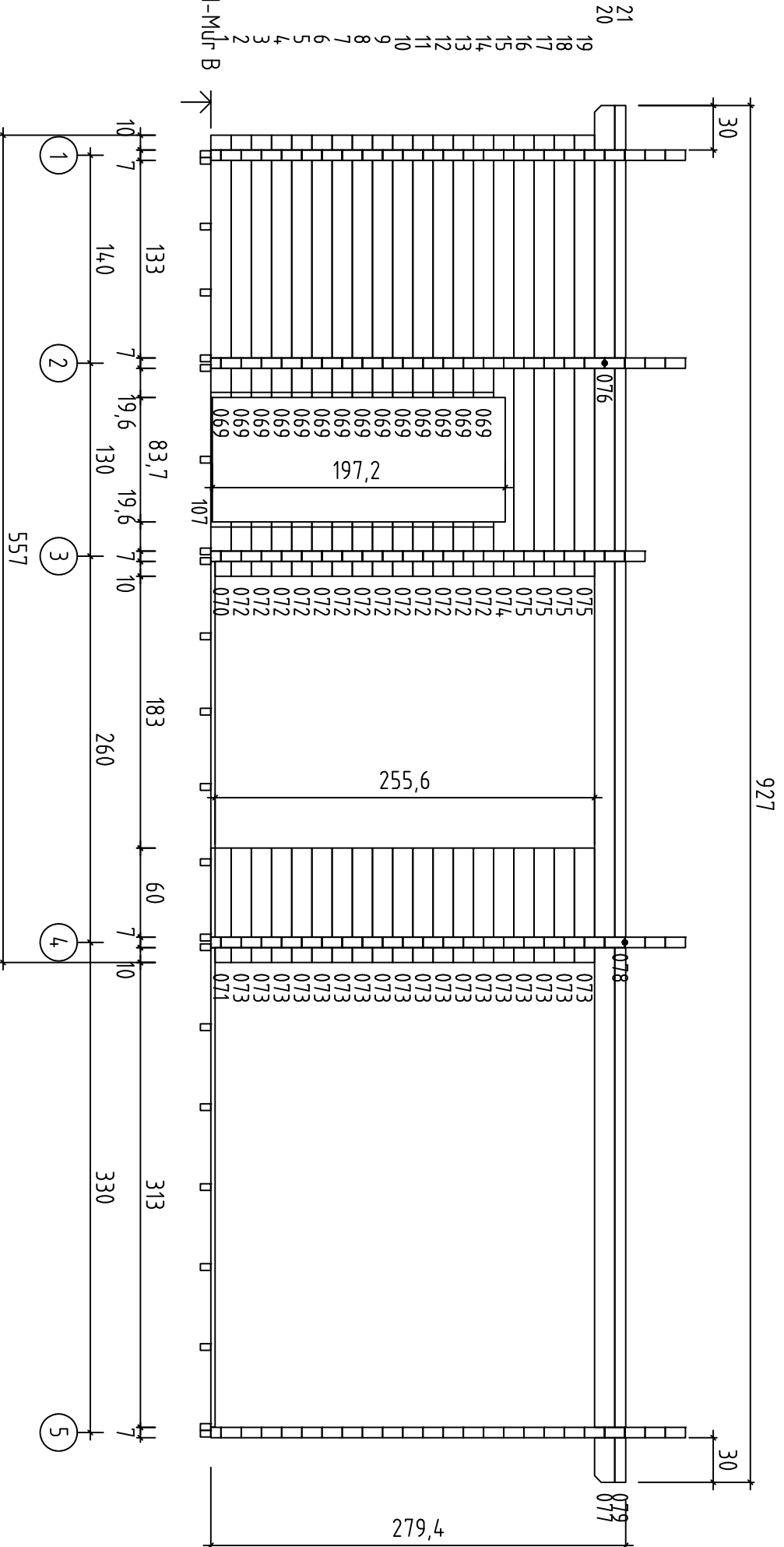

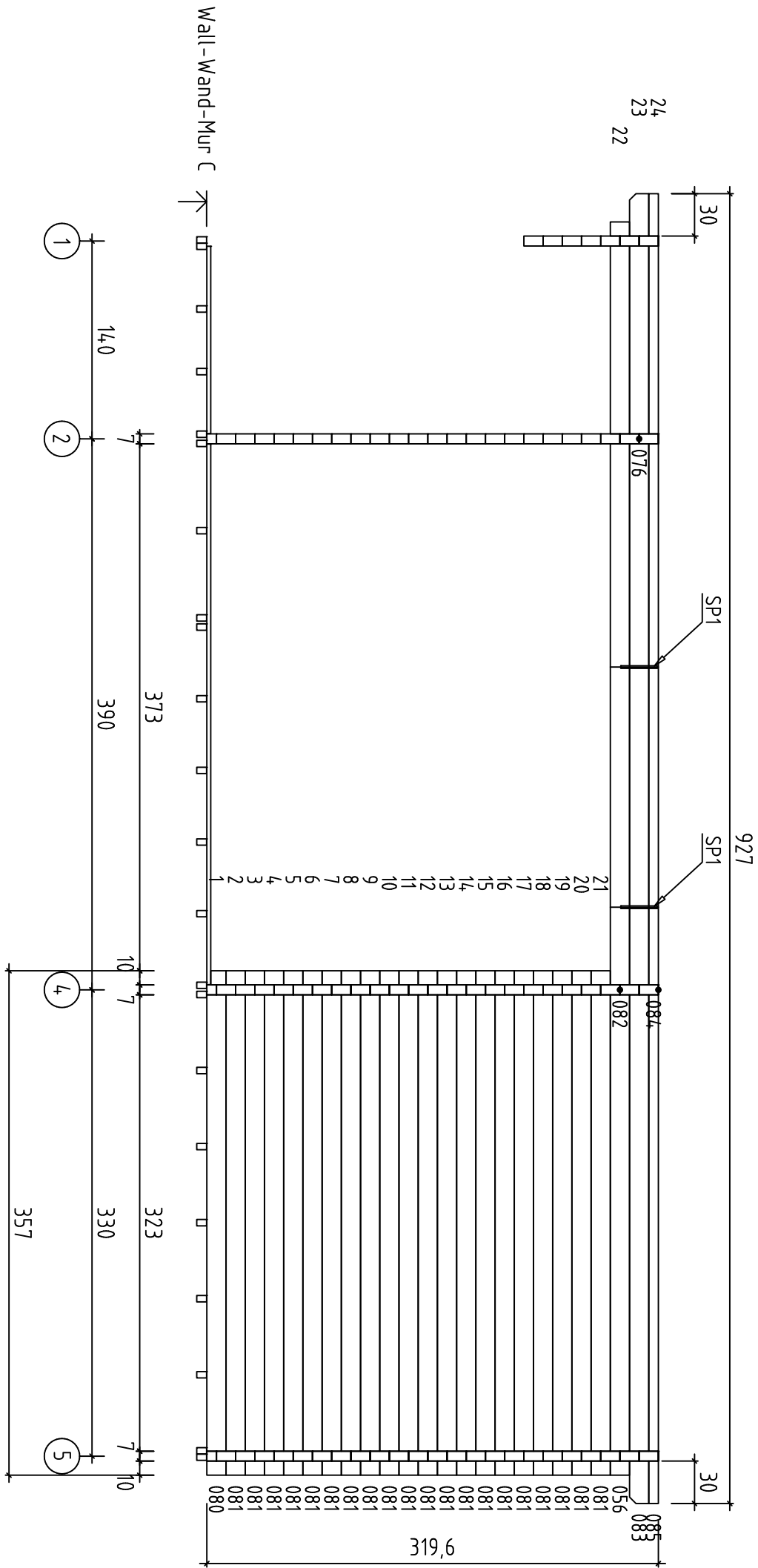

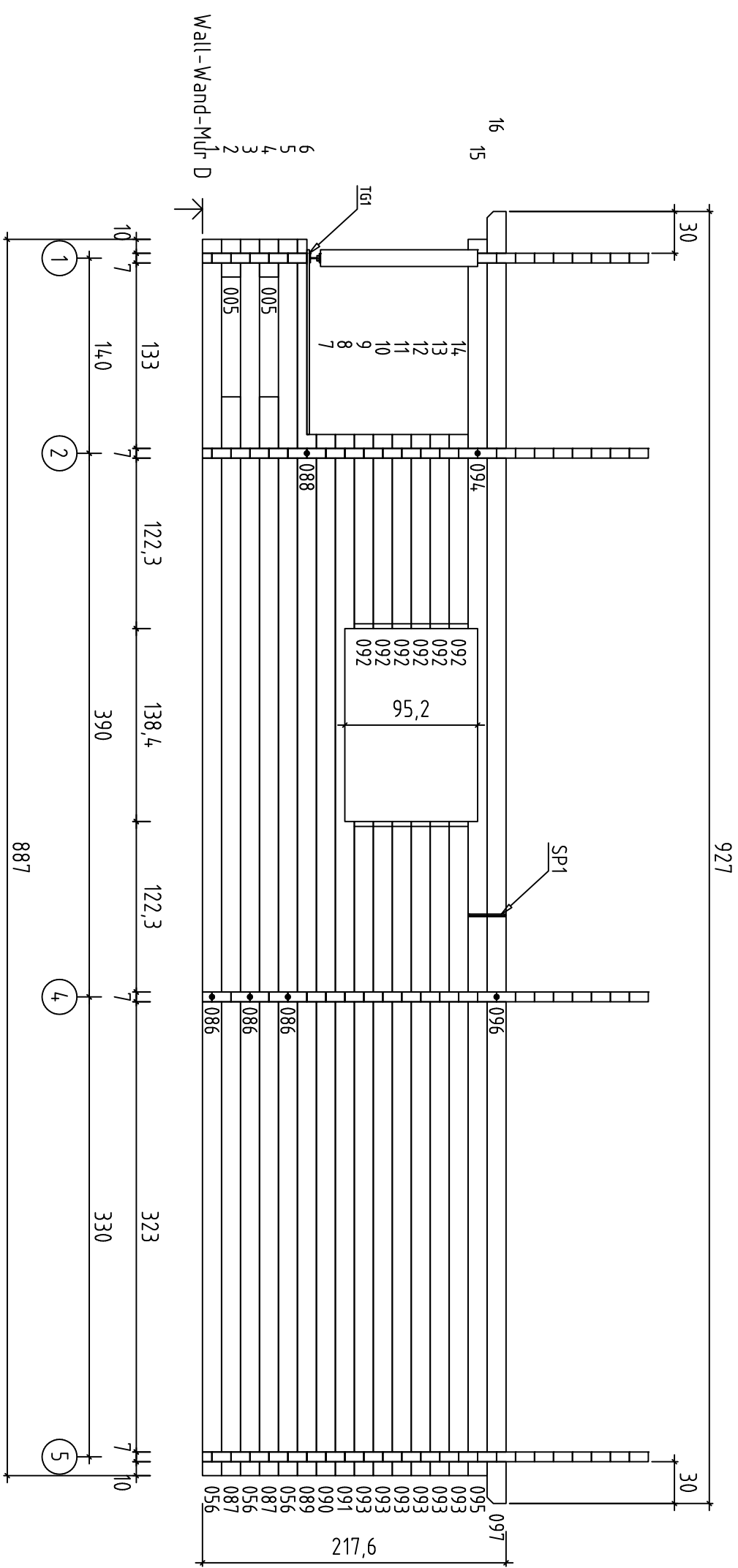

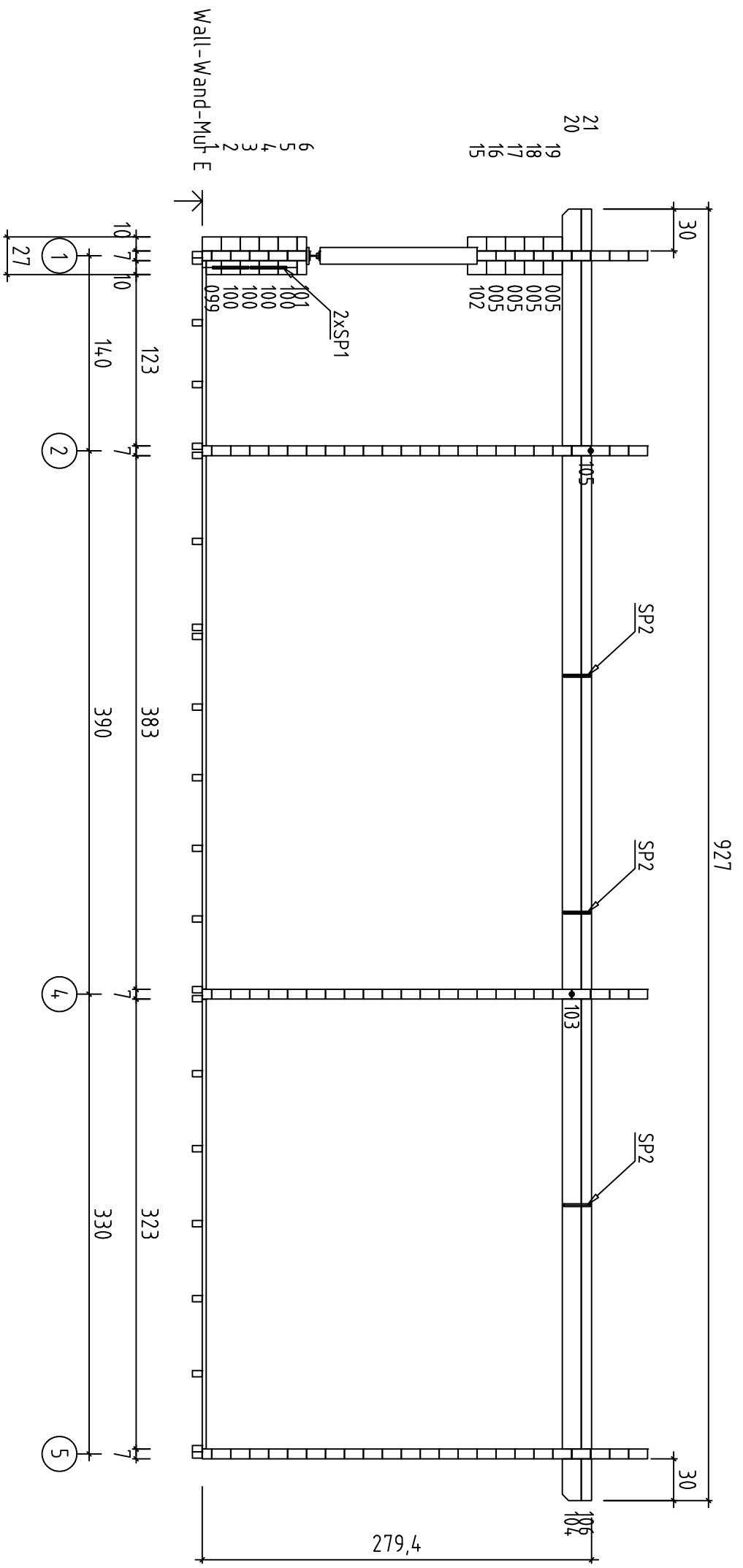

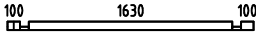
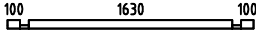
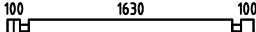
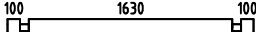

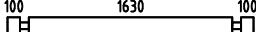
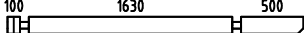

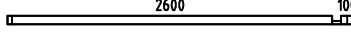

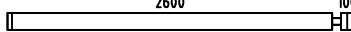

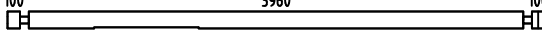
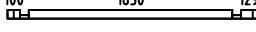
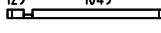
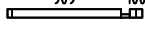
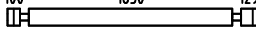
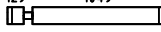
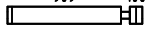
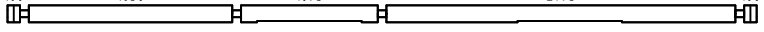
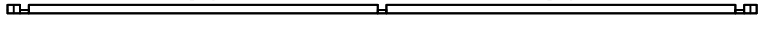
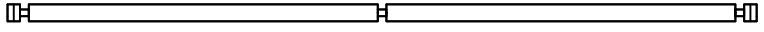
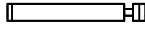
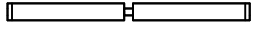

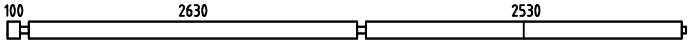
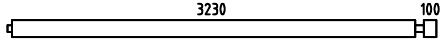
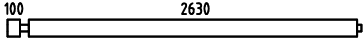
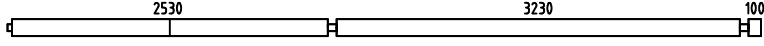
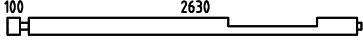
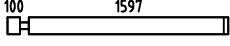
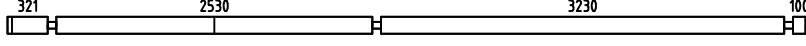
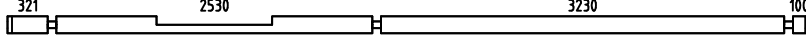
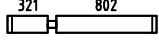
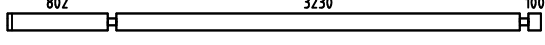
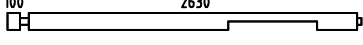
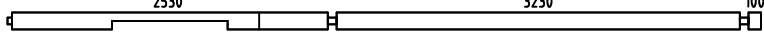
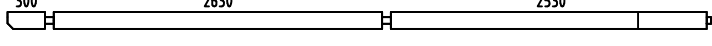
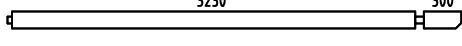
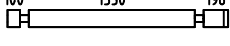

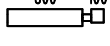

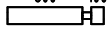
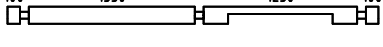
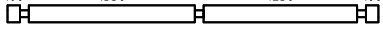
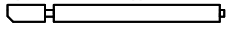
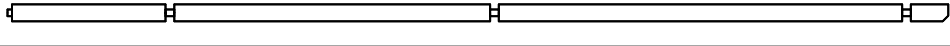
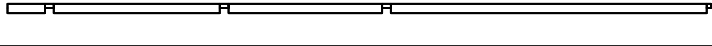
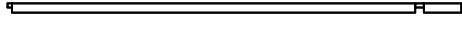



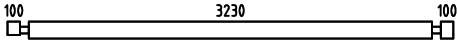
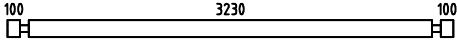
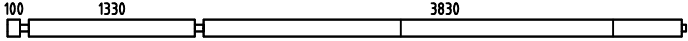
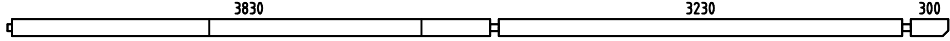
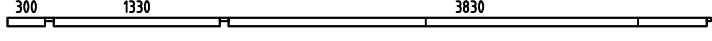
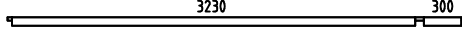
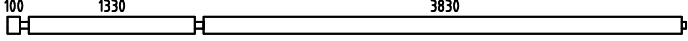
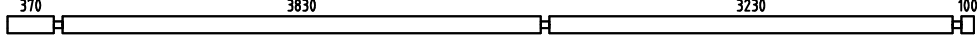
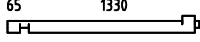
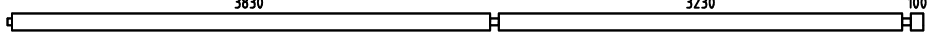
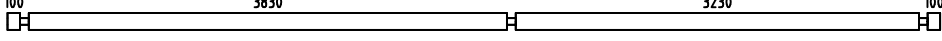
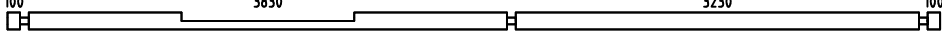
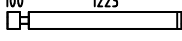
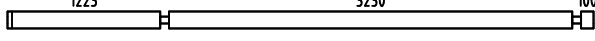
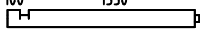
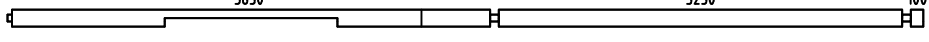
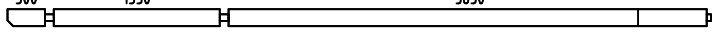
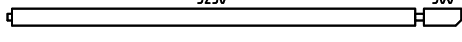
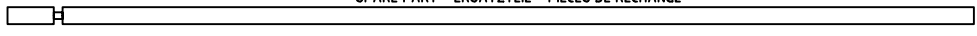



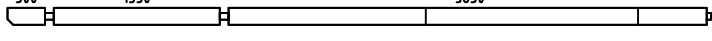
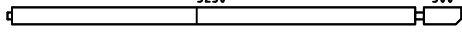

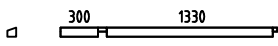
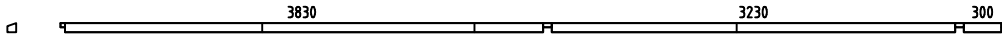

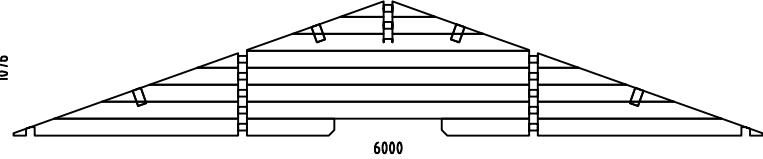
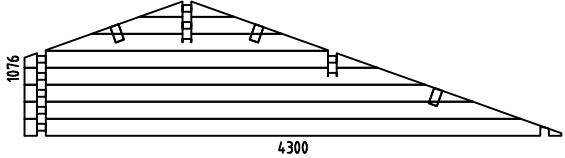
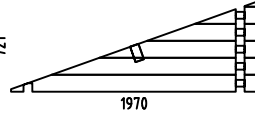
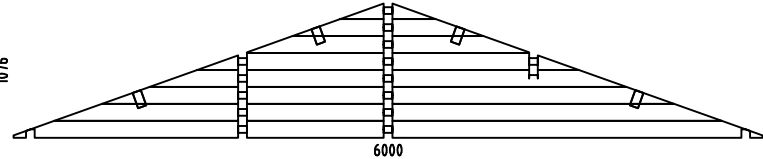
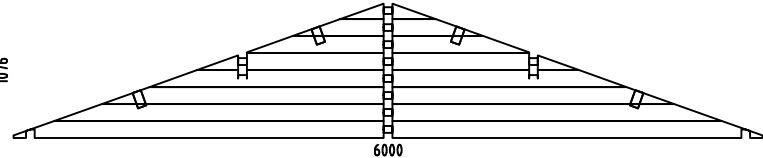
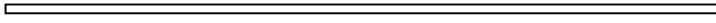
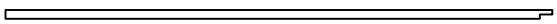

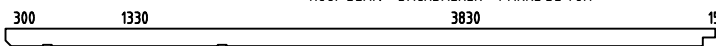
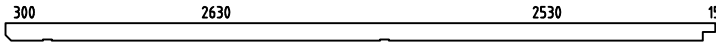
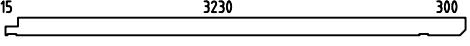







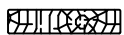









Pos	Indus 70, Art.No.702141 Piece list - Stückliste - Liste des pieces	Q.	P (mm)	L (mm)
001		1	70x68	1970
002		2	70x68	1970
003		14	70x136	1970
004		17	70x136	1970
005		10	70x136	270
006		1	70x136	1970
007		2	70x136	2370
016		1	70x68	693
017		1	70x68	2770
018		14	70x136	693
019		7	70x136	2770
020		7	70x136	693
021		7	70x136	693
022		1	70x136	4300
034		1	70x68	1999
035		1	70x68	1248
036		1	70x68	1079
037		14	70x136	1999
038		14	70x136	1248
039		14	70x136	1079
040		1	70x136	6000
047		1	70x68	6000
048		8	70x136	6000
049		14	70x136	1104
050		7	70x136	1939

Pos	Indus 70, Art.No.702141 Piece list - Stückliste - Liste des pieces	Q.	P (mm)	L (mm)
055		3	70x136	5435
056		7	70x136	3435
057		2	70x136	2835
058		3	70x136	6035
059		1	70x136	2835
060		8	70x136	1767
061		1	70x136	6391
062		1	70x136	6391
063		6	70x136	1193
064		6	70x136	4272
065		1	70x136	2835
066		1	70x136	6035
067		1	70x136	5635
068		1	70x136	3635
069		14	70x136	1766
070		1	70x136	367
071		1	70x136	770
072		13	70x136	366
073		18	70x136	770
074		1	70x136	2970
075		4	70x136	2970
076		2	70x136	1735
077		1	70x136	7535
078		1	70x74	5635
079		1	70x74	3635

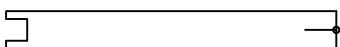
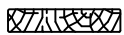

Pos	Indus 70, Art.No.702141 Piece list - Stückliste - Liste des pieces	Q.	P (mm)	L (mm)
080		1	70x136	3570
081		20	70x136	3570
082		1	70x136	5435
083		1	70x136	7535
084		1	70x68	5635
085		1	70x68	3635
086		3	70x136	5435
087		2	70x136	7740
088		1	70x136	1535
089		1	70x136	7335
090		1	70x136	7470
091		1	70x136	7470
092		6	70x136	1393
093		6	70x136	4693
094		1	70x136	1535
095		1	70x136	7335
096		1	70x136	5635
097		1	70x136	3635
098		1	70x136	7740
099		1	70x136	270
100		4	70x136	270
101		1	70x68	270
102		1	70x136	270
103		1	70x136	5635
104		1	70x136	3635

Pos	Indus 70, Art.No.702141 Piece list - Stückliste - Liste des pieces	Q.	P (mm)	L (mm)
105		1	70x74	1735
106		1	70x74	7535
107		4	70x10	837
W1-1		1		
W2-1		1		
W3-1		1		
W4-1		1		
W5-1		1		
IAR4	FOUNDATION - FUNDAMENT - FONDATION 	22	45x70	5700
IAR1	FOUNDATION - FUNDAMENT - FONDATION 	2	45x70	4380
IAR2	FOUNDATION - FUNDAMENT - FONDATION 	2	45x70	4380
IAR3	FOUNDATION - FUNDAMENT - FONDATION 	2	45x70	572
PR23	ROOF BEAM - DACHBALKEN - PANNE DE TOIT 	3	70x140	5685
PR21	ROOF BEAM - DACHBALKEN - PANNE DE TOIT 	1	70x140	5685
PR22	ROOF BEAM - DACHBALKEN - PANNE DE TOIT 	4	70x140	3685
PTL	FLOOR BOARDS - FUSSBODENBRETTER - LAME DE PLANCHER 	36	112x28	3826
PTL	FLOOR BOARDS - FUSSBODENBRETTER - LAME DE PLANCHER 	50	112x28	3226
PTL	FLOOR BOARDS - FUSSBODENBRETTER - LAME DE PLANCHER 	15	112x28	2626
PTL	FLOOR BOARDS - FUSSBODENBRETTER - LAME DE PLANCHER 	15	112x28	2526
	ROOF BOARDS - DACHBRETTER - VOLIGES 	206	90x18	3400

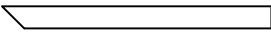
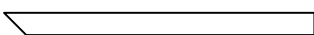
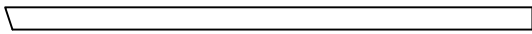
Pos	Indus 70, Art.No.702141 Piece list - Stückliste - Liste des pieces	Q.	P (mm)	L (mm)
	TERRACE BOARDS - TERRASSENBRETT - PLANCHER DE TERRASSE 	32	120x28	1326
	FLOOR FILLET-FUSSBODENLEISTE - CORNIERE DE FINITION DU PLANCHER 		15x40	51.5 m.
TBE5	TERRACE EDGE BOARD - TERRASSENBRETT, EINGANG - LAME DE SEUIL D'ENTREE DE TERRASSE 	1	28x70	2060
DPL	ROOFING FELT FILLET - DACHPAPPENLEISTE - BAGUETTE DE FIXATION DU FEUTRE BITUMEUX 	4	18x58	3450
M1	TREADED ROD M12 - GEWINDESTANGE M12 - TIGE FILETÉE M12 	6		165
M2	TREADED ROD M12 - GEWINDESTANGE M12 - TIGE FILETÉE M12 	1		190
M3	TREADED ROD M12 - GEWINDESTANGE M12 TIGE FILETÉE M12 	6		2000
LPL	FIXING FILLET - FIXIRUNGSLEISTE - PROFIL DE FIXATION 	2	20x70	662
LPL	FIXING FILLET - FIXIRUNGSLEISTE - PROFIL DE FIXATION 	4	20x70	787
LPL	FIXING FILLET - FIXIRUNGSLEISTE - PROFIL DE FIXATION 	6	20x70	876
LPL	FIXING FILLET - FIXIRUNGSLEISTE - PROFIL DE FIXATION 	10	20x70	916
LPL	FIXING FILLET - FIXIRUNGSLEISTE - PROFIL DE FIXATION 	2	20x70	1190
LPL	FIXING FILLET - FIXIRUNGSLEISTE - PROFIL DE FIXATION 	4	20x70	1334
LPL	FIXING FILLET - FIXIRUNGSLEISTE - PROFIL DE FIXATION 	8	20x70	1933
P	POST - PFOSTEN - POTEAU 	2	120x120	1125
TB	EAVES BOARD - TRAUFBRETT - BANDEAU DE TOIT 	4	18x90	4635
DRV	ROOF EDGE REINFORCEMENT - DACHRANDVERSTÄRKUNG - CORNIERE DE RENFORT DE BORD DE TOIT 	4	28x34	4635
TBE6	FIXING FILLET FOR WINDOW - FIXIRUNGSLEISTE FÜR FENSTER - PROFIL DE FIXATION DES FENETRES 	4	28x34	748
TBE6	FIXING FILLET FOR WINDOW - FIXIRUNGSLEISTE FÜR FENSTER - PROFIL DE FIXATION DES FENETRES 	6	28x34	916
TBE6	FIXING FILLET FOR WINDOW - FIXIRUNGSLEISTE FÜR FENSTER - PROFIL DE FIXATION DES FENETRES 	2	28x34	1020
TBE6	FIXING FILLET FOR DOOR - FIXIRUNGSLEISTE FÜR TÜR - PROFIL DE FIXATION DES PORTES 	2	28x34	1835
TBE6	FIXING FILLET FOR DOOR - FIXIRUNGSLEISTE FÜR TÜR - PROFIL DE FIXATION DES PORTES 	6	28x34	1933
TG1	GUARD-RAIL FOR TERRACE - TERRASSENSELÄNDER MAIN COURANTE DE TERRASSE 	1	18x120	1325
TG2	GUARD-RAIL FOR TERRACE - TERRASSENSELÄNDER MAIN COURANTE DE TERRASSE 	1	18x120	1895
GL	GABLE MOULDING - GIEBELLEISTE PLANCHE DE RIVE 	4	18x120	3450

Pos	Indus 70, Art.No.702141 Piece list - Stückliste - Liste des pieces		Q.	P (mm)	L (mm)
SP2	HIDDEN FIXING - HOLZDÜBEL - TOURILLON BOIS		3	18x18	190
SP1	HIDDEN FIXING - HOLZDÜBEL - TOURILLON BOIS		10	18x18	260
SH70	HAMMER BLOCK - SCHLAGHOLZ - CALLE DE FRAPPE		2		
GS	GABLE SEGMENT-DECKBLATT - LOSANGE DE FINITION		2		
KL4	LENGTHENING BOLT FOR TREADED ROD - VERLÄNGERUNGSMUTTER FÜR GEWINDESTANGE - MANCHON DE RACCORDEMENT DE TIGE FILETÉE		6		
KL1	DRIVE NUT TREADED ROD - EINSHLAGMUTTER FÜR GEWINDESTANGE - ÉCROU A FRAPPER POUR TIGE FILITÉE		7		
KL2	NUT FOR TREADED ROD - MUTTER FÜR GEWINDESTANGE - ÉCROU POUR TIGE FILETÉE		7		
KL3	PLAIN WASHER TREADED ROD - UNTERLEGSSCHEIBE FÜR GEWINDESTANGE - RONDELLE PLATE POUR TIGE FILETÉE		7		
HS12	SCREW FOR GABLE SEGMENT - SCHRAUBEN FÜR DECKBLATT - VIS POUR FIXATION LOSANGE DE FINITION		4	3.5x35	
HS83	SCREW FOR FIXING FILLET - SCHRAUBEN FÜR FIXIRUNGSLEISTE - VIS POUR PROFIL DE FIXATION		152	3.5x50	
HS84	SCREW FOR FIXING FILLET - SCHRAUBEN FÜR FIXIRUNGSLEISTE - VIS POUR PROFIL DE FIXATION		88	3.5x50	
HS16	SCREW FOR GABLE MOULDING - SCHRAUBEN FÜR GIEBELLEISTE - VIS DE FIXATION POUR PLANCHE DE RIVE		40	3.5x50	
HS32	SCREW FOR EAVES BOARDS - SCHRAUBEN FÜR TRAUFBRETT - VIS DE FIXATION POUR BANDEAU DE TOIT		40	18x120	
HS26	SCREW FOR ROOF EDGE REINFORCEMENT - SCHRAUBEN FÜR DACHRANDVERSTÄRKUNG - VIS POUR RENFORT DE BORD DE TOIT		40	4x40	
HS30	SCREW FOR TERRACE REAR BOARDS - SCHRAUBEN FÜR TERRASSENRAND - VIS DE FIXATION POUR MAIN COURANTE DE TERRASSE		12	4x40	
HS34	SCREW FOR POST - SCHRAUBEN FÜR PFOSTEN - VIS DE FIXATION DES POTEAUX		4	4x60	
NF3	SCREW FOR TERRACE BOARD - SCHRAUBE FÜR TERRASSENBRETT - VIS POUR LAME DE SEUIL D'ENTREE DE TERRASSE		5	4x60	
HS17	SCREW FOR FLOOR BOARDS - SCHRAUBEN FÜR FUSSBODENBRETT - VIS D'ASSEMBLAGE DES LAMES DE PLANCHER		810	4x60	
HS40	SCREW FOR 1. WALL BEAM - SCHRAUBE FÜR 1. BOHLENREIHE - VIS DE FIXATION DES FONDATIONS		26	5x120	
HS42	SCREW FOR GABLE - SCHRAUBEN FÜR GIEBEL - VIS POUR FIXATION DES PIGNONS		57	5x120	
HS43	SCREW FOR ROOF BEAMS - SCHRAUBEN FÜR DACHBALKEN - VIS POUR PANNE DE TOIT		45	5x120	
HS39	SCREW FOR FUNDAMENT - SCHRAUBEN ZUR BEFESTIGUNG FUNDAMENT - VIS POUR FONDATION		60	5x90	
HS49	SCREW FOR POST HEIGHT ADJUSTMENT - SCHRAUBEN FÜR REGULIERUNGSSCHRAUBE FÜR PFOSTEN - VIS DE FIXATION DE SUPPORT RÉGLABLE DE POTEAU		16	6x50	
	SCREW FOR DOORSTEP - SCHRAUBEN FÜR TÜRSCHWELLE - VIS DE FIXATION DU SEUIL DE PORTE		8	4.5x65	
NF3	SCREW FOR TERRACE BOARD - SCHRAUBE FÜR TERRASSENBRETT - VIS POUR LAME DE SEUIL D'ENTREE DE TERRASSE		256	4.2x55	

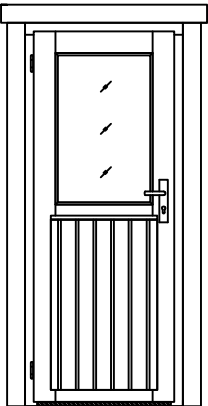
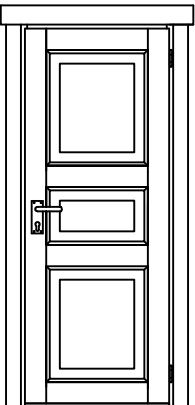
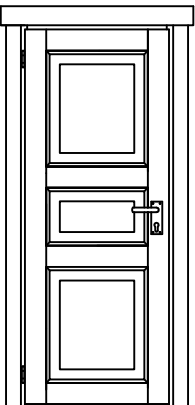

Pos	Indus 70, Art.No.702141 Piece list - Stückliste - Liste des pieces	Q.	P (mm)	L (mm)
2+ U .20V	DOOR-TÜR-PORTE 827x1933  	1		
U.3TP	DOOR-TÜR-PORTE 827x1933  	1		
U.3TV	DOOR-TÜR-PORTE 827x1933  	2		

