

Liverpool 1
Art. Nr.7016344

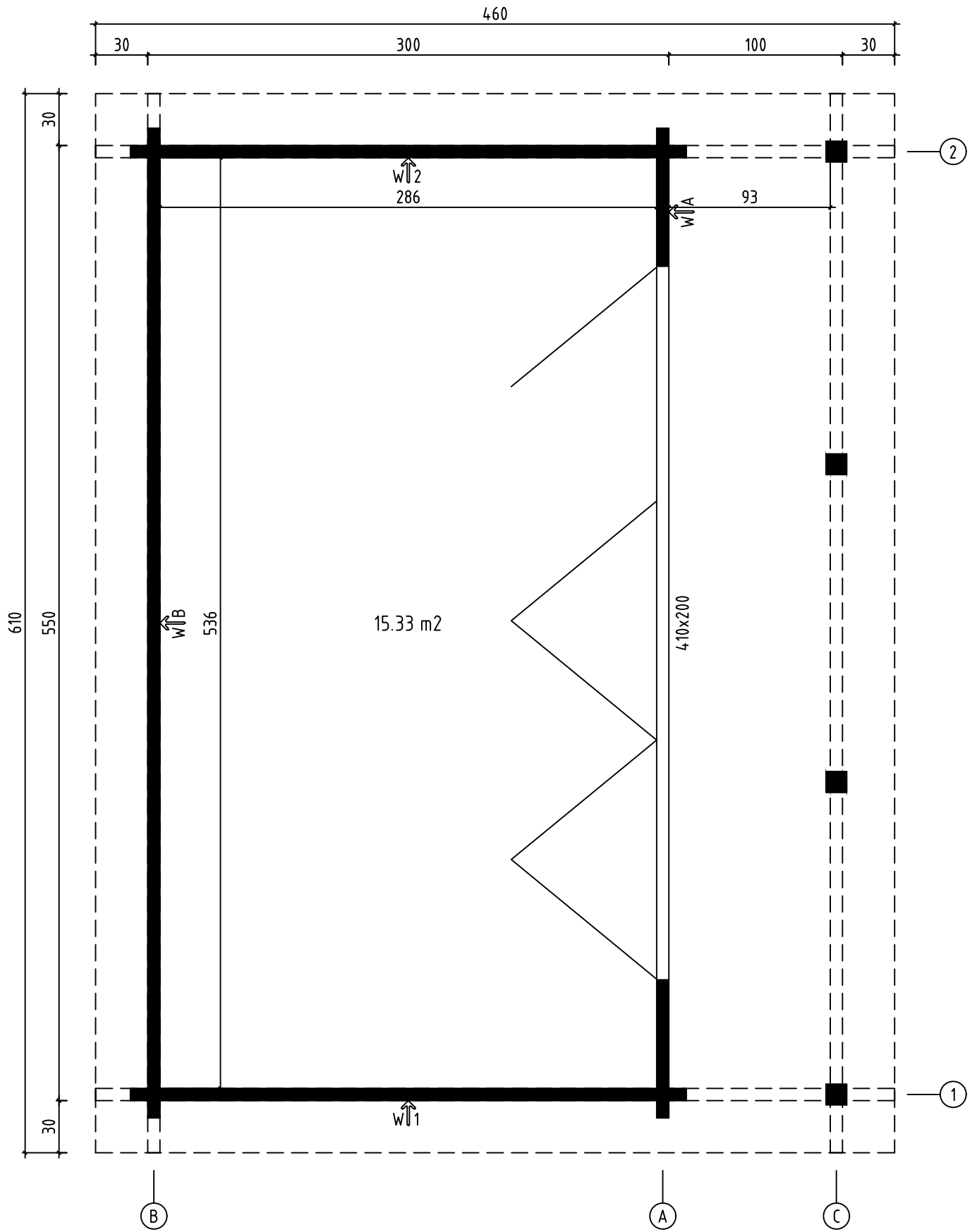

GROUNDPLAN - GRUNDPLAN - PLAN DE MASSE



FOUNDATION - FUNDAMENT - FONDATION

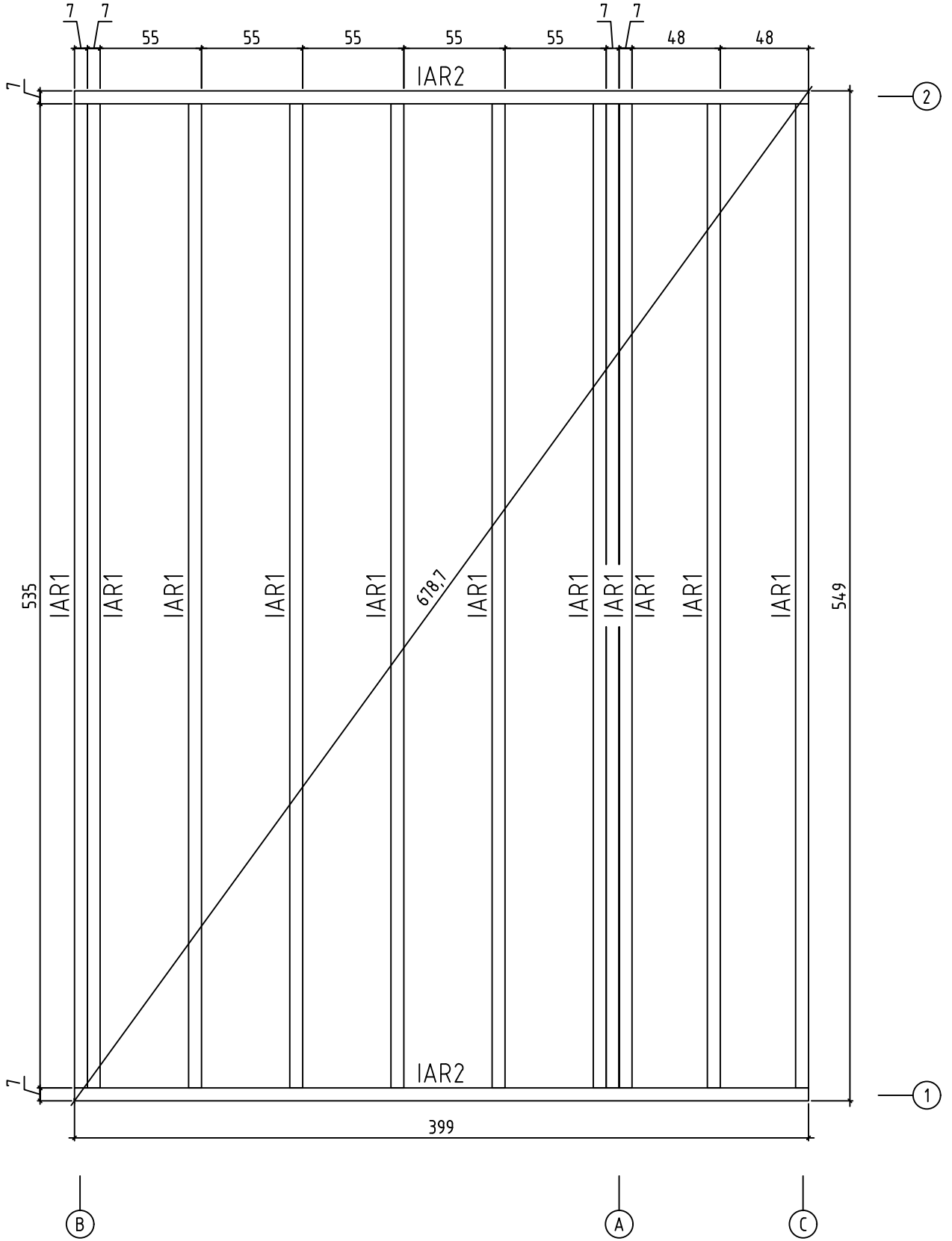

FLOOR BOARDS - FUSSBODENBRETTER - LAME DE PLANCHER
TERRACE BOARDS - TERRASSENBRETTER - PLANCHER DE TERRASSE

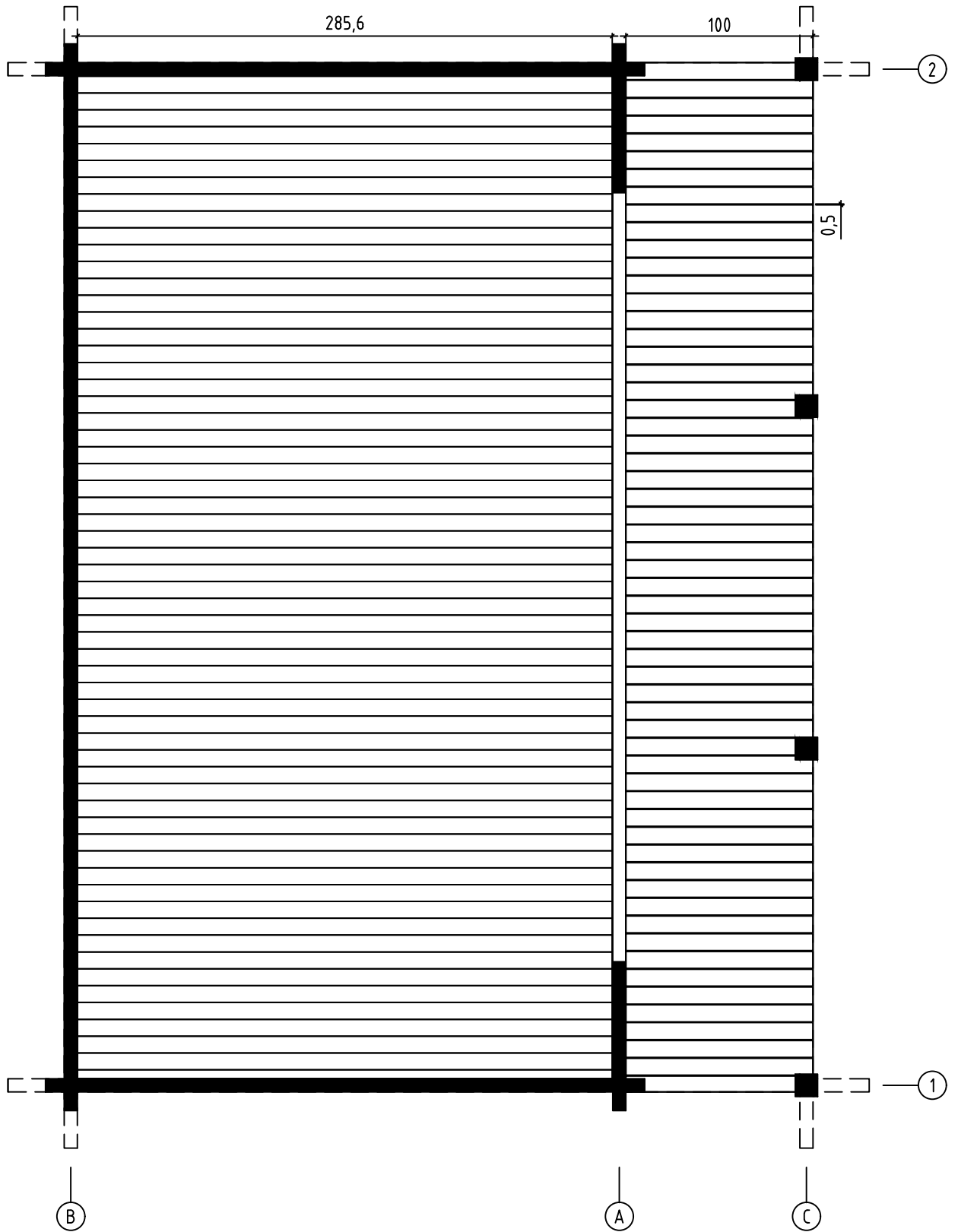

7016344 - Liverpool 1

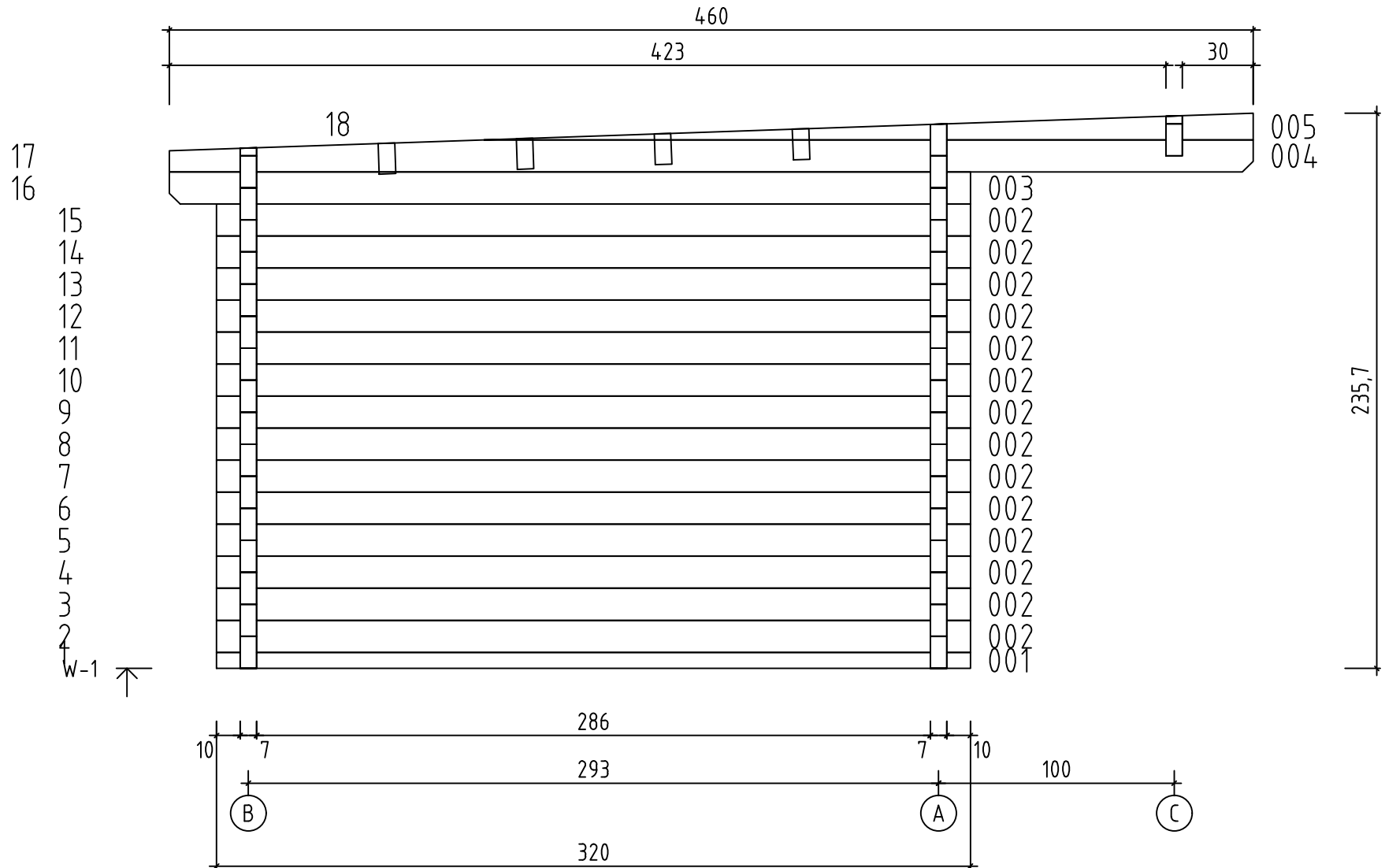

7016344 - Liverpool 1

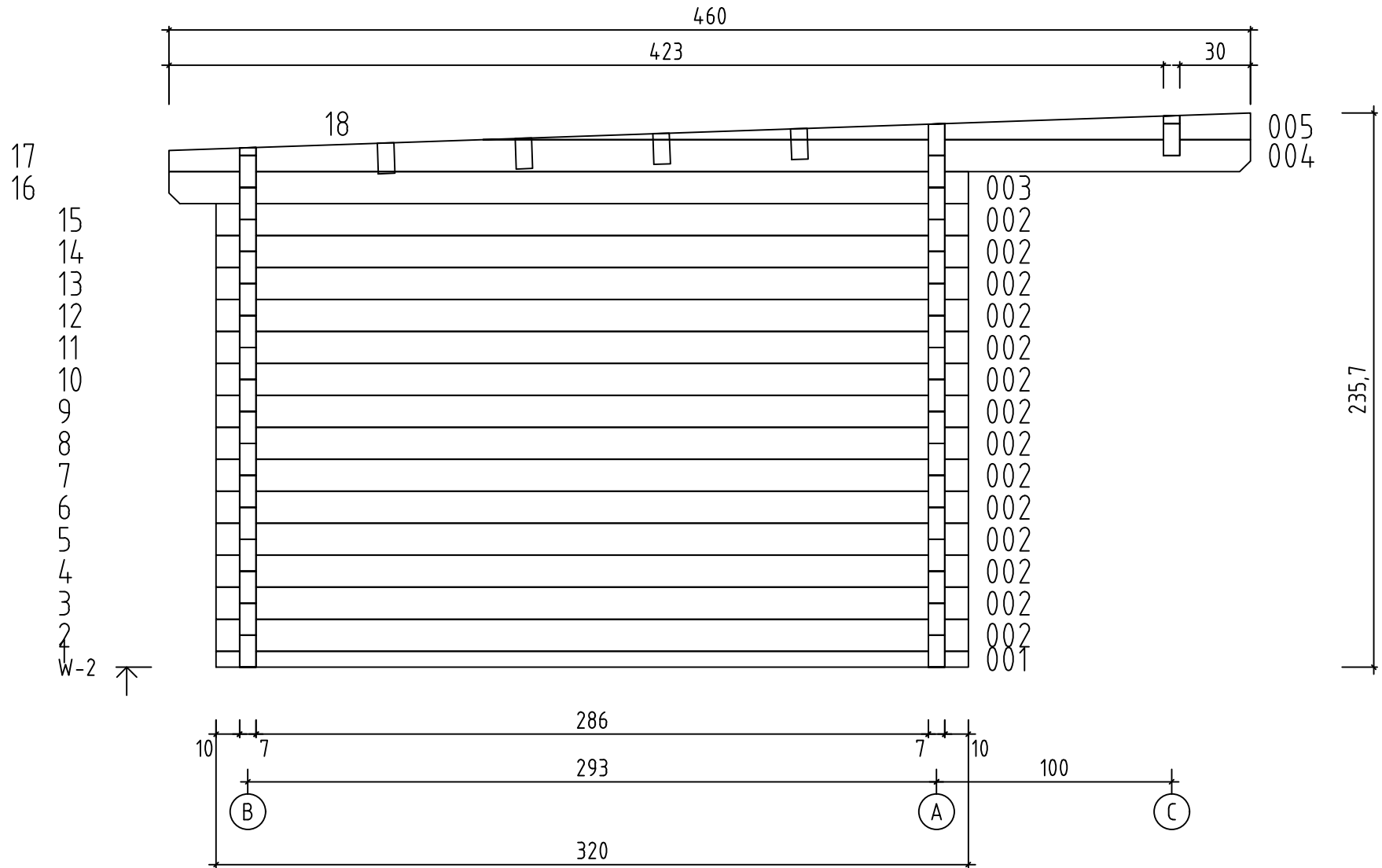

7016344 - Liverpool 1

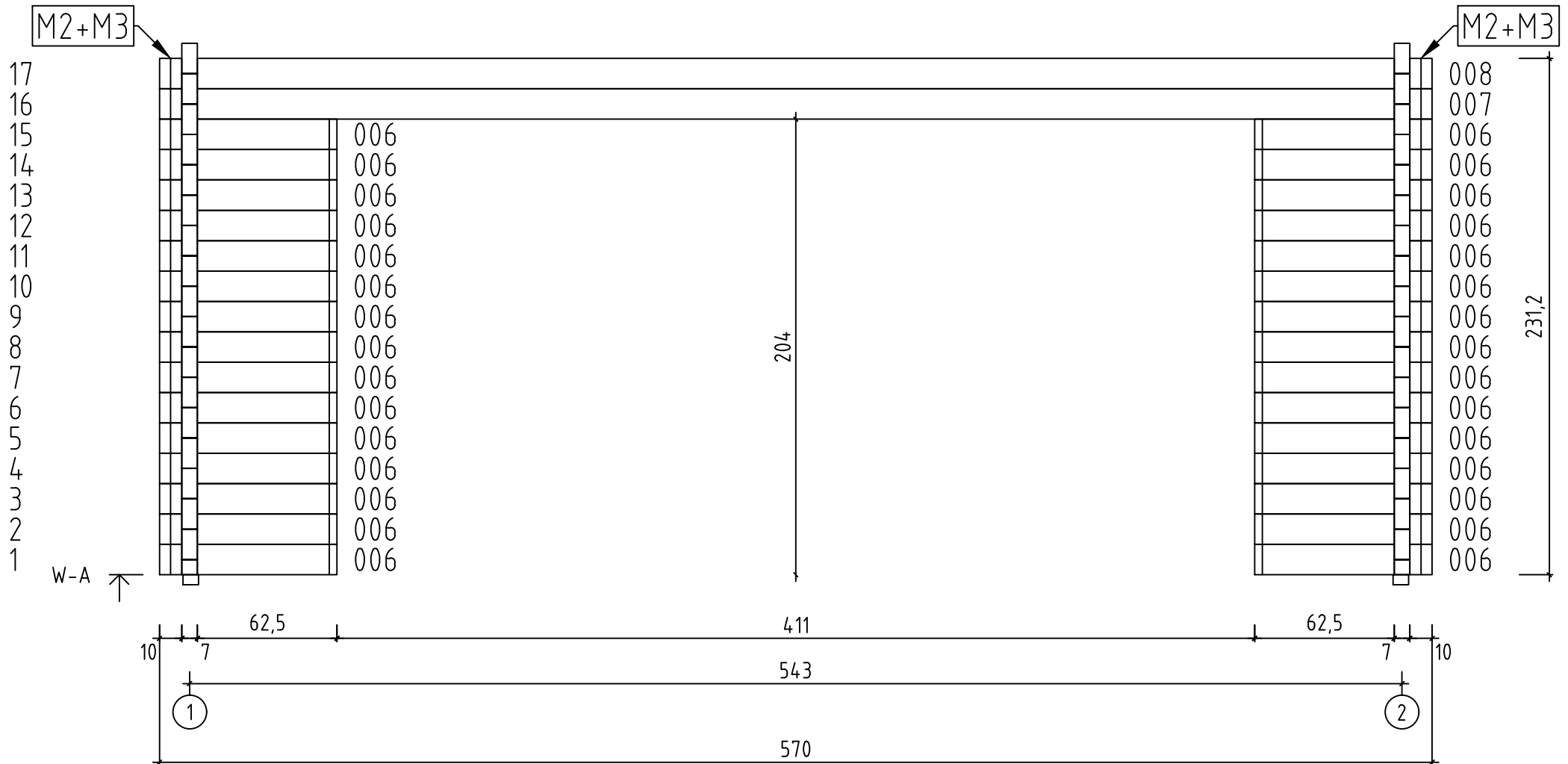

7016344 - Liverpool 1

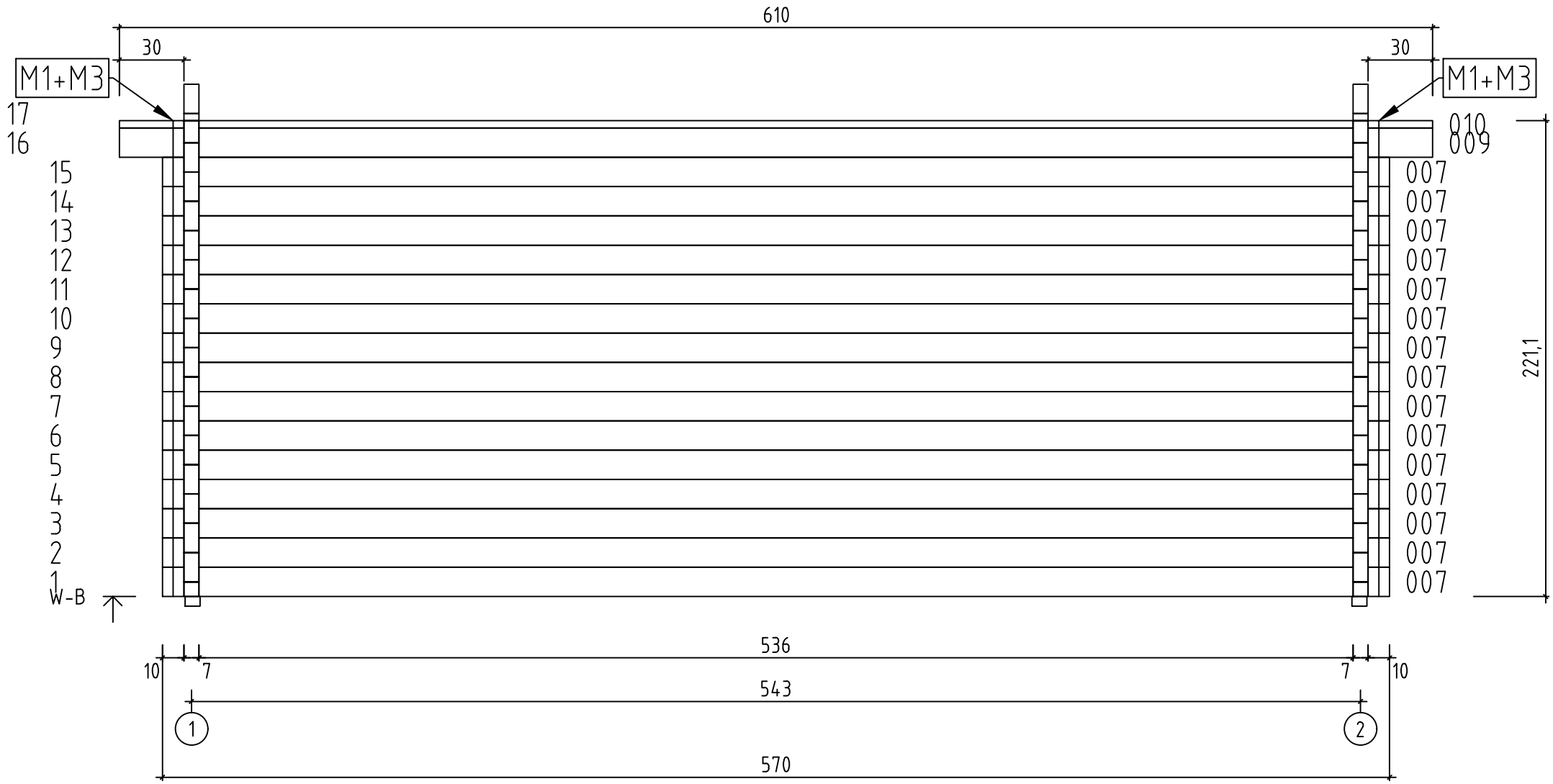



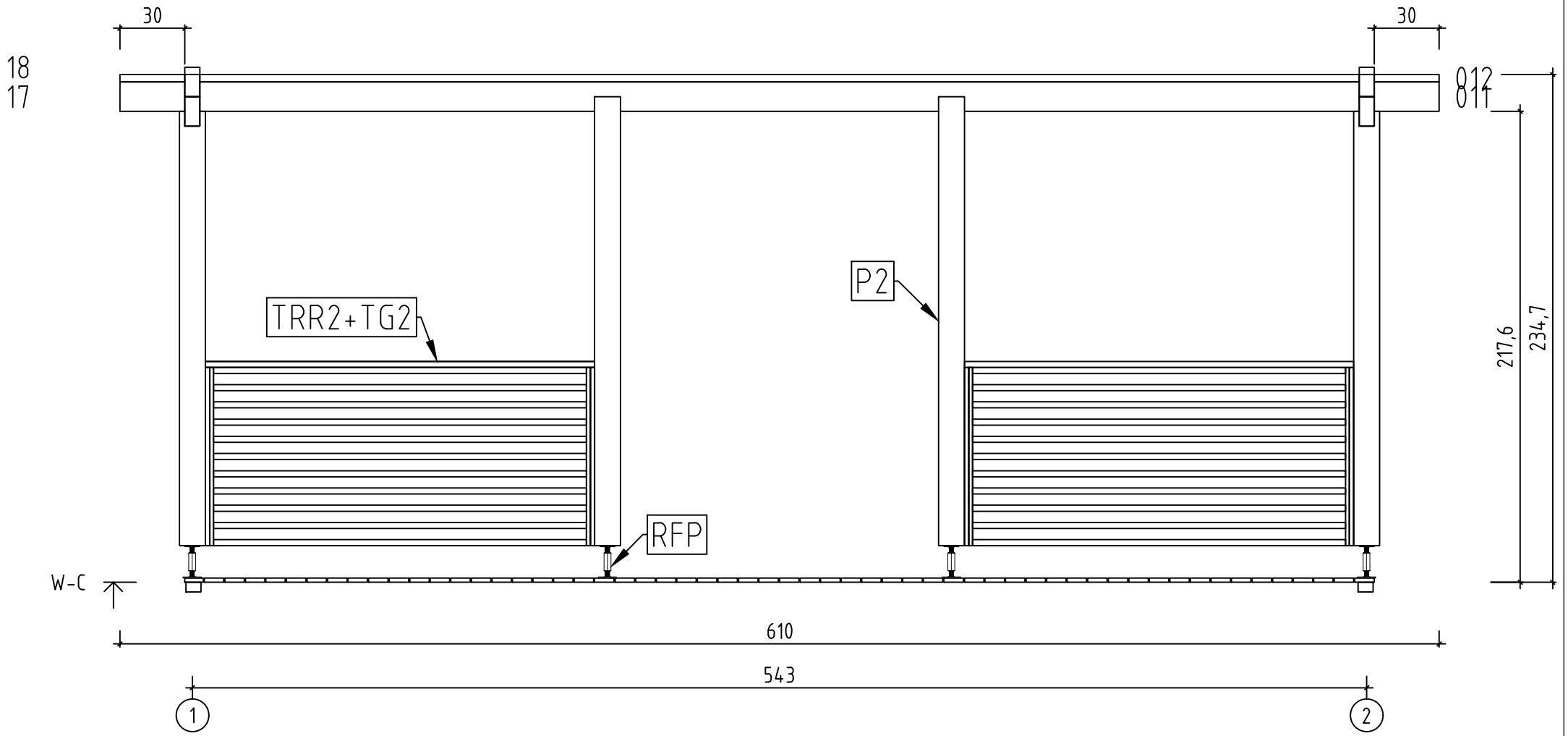



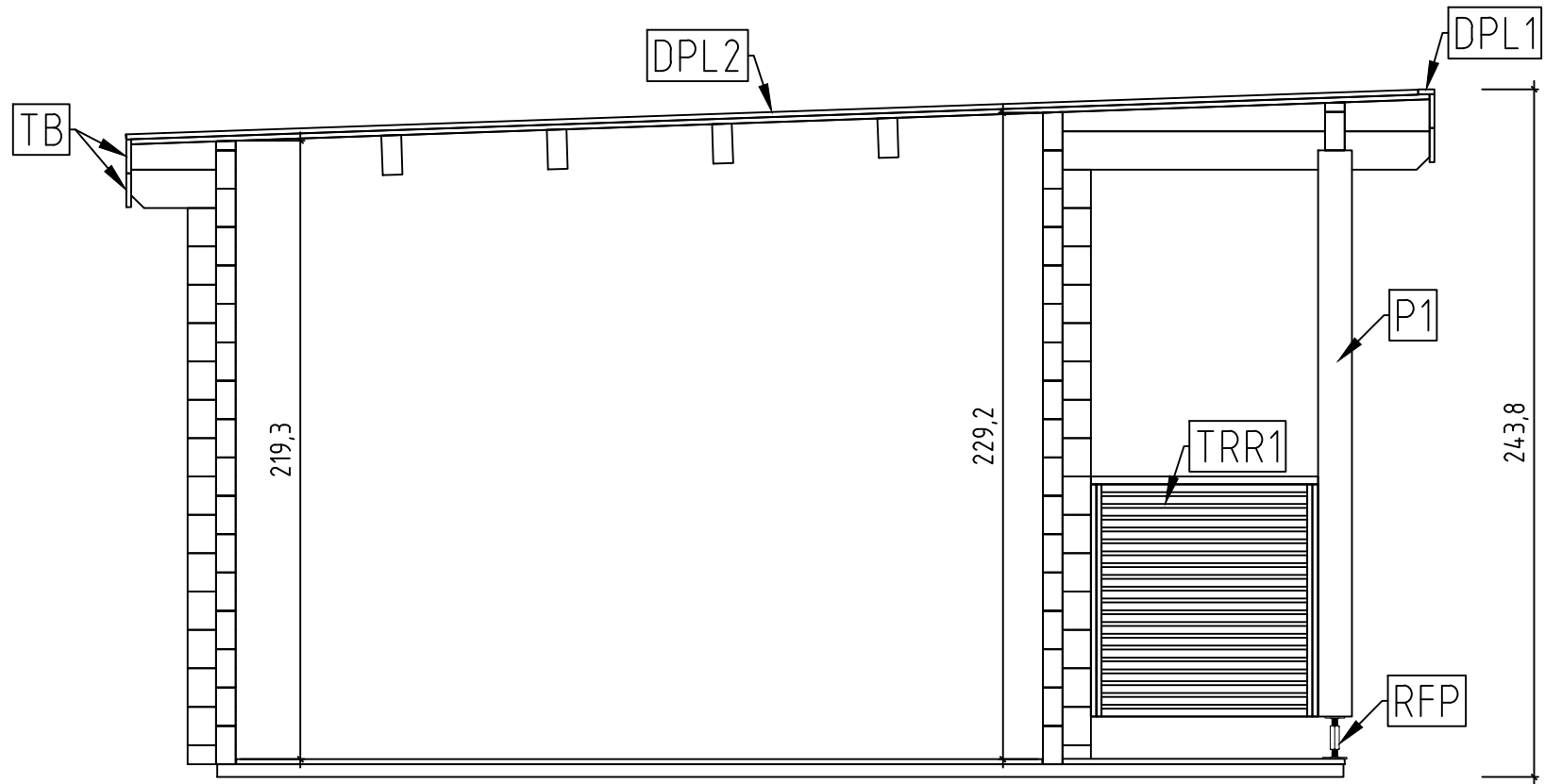

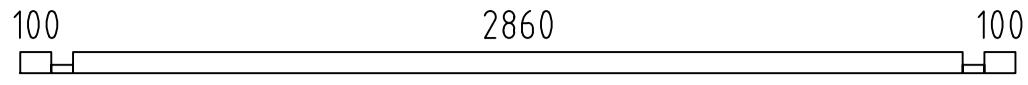
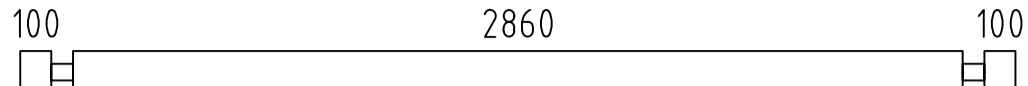
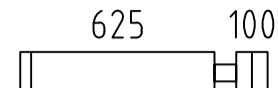
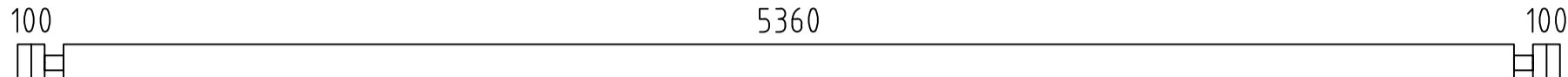
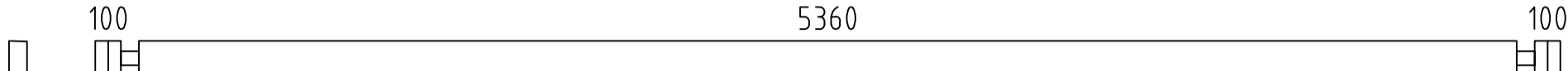
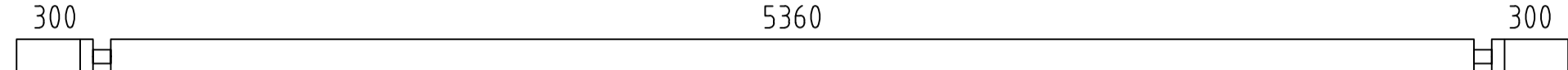
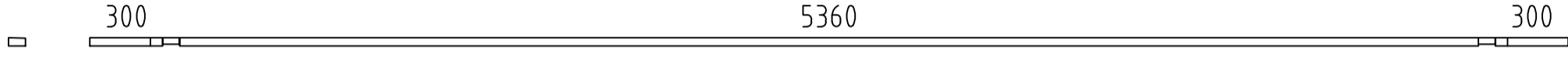
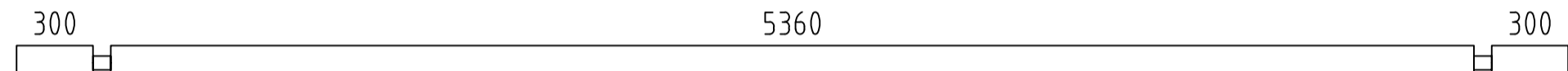
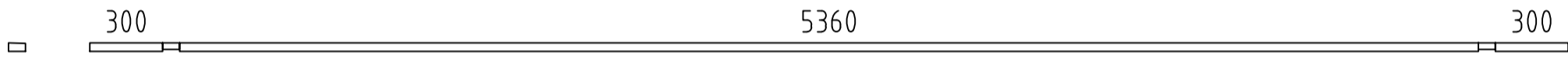
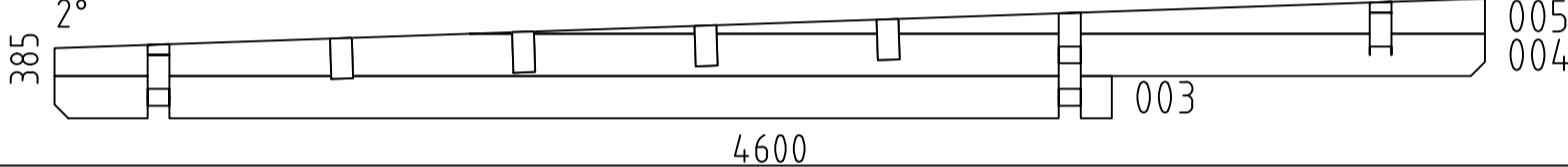
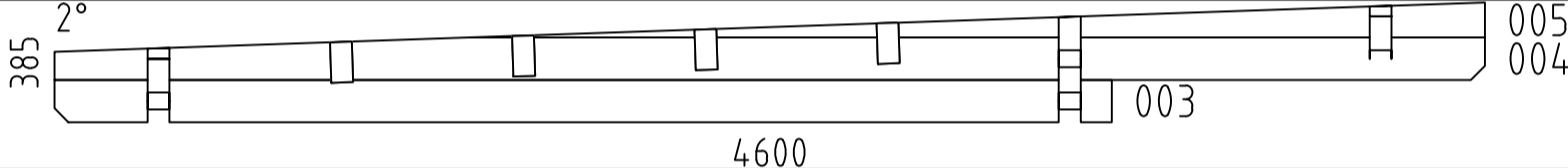
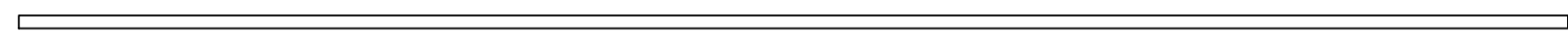

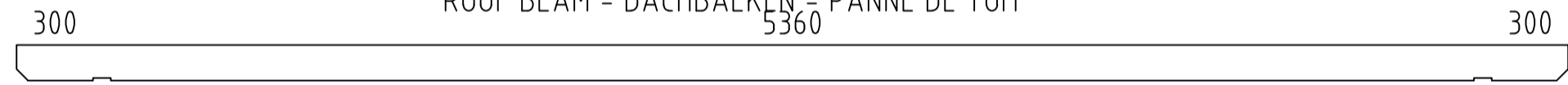
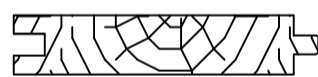
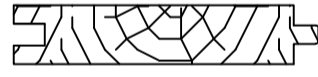



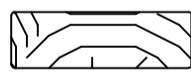
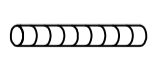
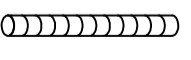

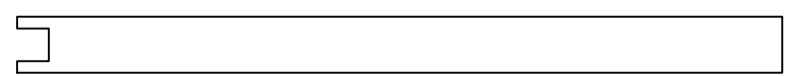
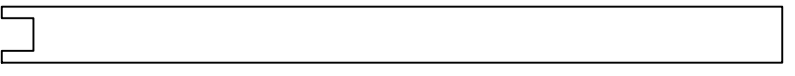



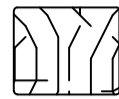
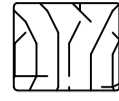
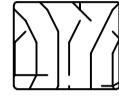
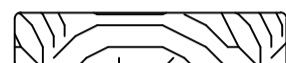
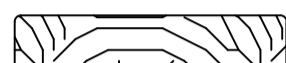
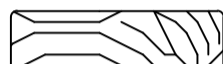
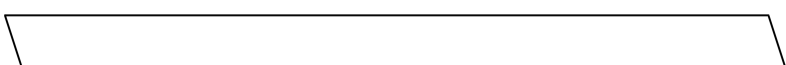
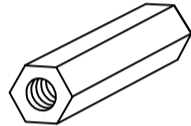

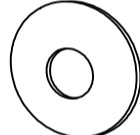

7016344 - Liverpool 1

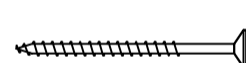



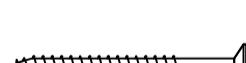





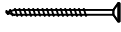
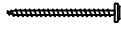

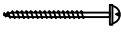
7016344 - Liverpool 1

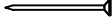

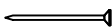
| Pos | 7016344 - Liverpool 1 Piece list - Stückliste - Liste des pieces | Q. | P (mm) | L (mm) |
|-------|---|----|-----------|-----------|
| 001 |  | 2 | 70x68 | 3200 |
| 002 |  | 28 | 70x136 | 3200 |
| 006 |  | 30 | 70x136 | 795 |
| 007 |  | 16 | 70x136 | 5700 |
| 008 |  | 1 | 70x136 | 5700 |
| 009 |  | 1 | 70x136 | 6100 |
| 010 |  | 1 | 70x35 | 6100 |
| 011 |  | 1 | 70x136 | 6100 |
| 012 |  | 1 | 70x35 | 6100 |
| W1-1 |  | 1 | | |
| W2-1 |  | 1 | | |
| IAR1 | FOUNDATION - FUNDAMENT - FONDATION  | 11 | 70x45 | 5350 |
| IAR2 | FOUNDATION - FUNDAMENT - FONDATION  | 2 | 70x45 | 3990 |
| A-PR1 | ROOF BEAM - DACHBALKEN - PANNE DE TOIT  | 4 | 70x140 | 6100 |
| FB-1 | FLOOR BOARDS - FUSSBODENBRETTER - LAME DE PLANCHER  | 60 | 90x18 | 2856 |
| RB-1 | ROOF BOARDS - DACHBRETTER - VOLIGES  | 68 | 90x18 | 4603 |
| SV-1 | TERRACE BOARDS - TERRASSENBRETTER - PLANCHER DE TERRASSE  | 58 | 90x19 | 1000 |
| FL-1 | FLOOR FILLET-FUSSBODENLEISTE - CORNIERE DE FINITION DU PLANCHER  | | 18x18 | 17 m. |
| DPL1 | ROOFING FELT FILLET - DACHPAPPENLEISTE - BAGUETTE DE FIXATION DU FEUTRE BITUMEUX  | 2 | 18x58 | 3068 |
| DPL2 | ROOFING FELT FILLET - DACHPAPPENLEISTE - BAGUETTE DE FIXATION DU FEUTRE BITUMEUX  | 2 | 18x58 | 4580 |
| M1 | TREADED ROD M12 - GEWINDESTANGE M12 - TIGE FILETÉE M12  | 2 | | 241 |
| M2 | TREADED ROD M12 - GEWINDESTANGE M12 - TIGE FILETÉE M12  | 2 | | 342 |
| M3 | TREADED ROD M12 - GEWINDESTANGE M12 - TIGE FILETÉE M12  | 4 | | 2000 |
| P1 | POST - PFOSTEN - POTEAU  | 2 | 120x120 | 2007 |
| P2 | POST - PFOSTEN - POTEAU  | 2 | 120x120 | 2075 |

| Pos | 7016344 - Liverpool 1 Piece list - Stückliste - Liste des pieces | | Q. | P (mm) | L (mm) |
|------|---|---|----|-----------|-----------|
| TB | EAVES BOARD - TRAUFBRETT - BANDEAU DE TOIT |  | 8 | 18x120 | 3068 |
| DRV1 | ROOF EDGE REINFORCEMENT - DACHRANDVERSTÄRKUNG - CORNIERE DE RENFORT DE BORD DE TOIT |  | 4 | 28x34 | 190 |
| DRV2 | ROOF EDGE REINFORCEMENT - DACHRANDVERSTÄRKUNG - CORNIERE DE RENFORT DE BORD DE TOIT |  | 4 | 28x34 | 3000 |
| TBE1 | FIXING FILLET - FIXIRUNGSLEISTE - PROFIL DE FIXATION |  | 2 | 28x34 | 2000 |
| TG1 | GUARD-RAIL FOR TERRACE - TERRASSEN GELÄNDER - MAIN COURANTE DE TERRASSE |  | 2 | 28x120 | 805 |
| TG2 | GUARD-RAIL FOR TERRACE - TERRASSEN GELÄNDER - MAIN COURANTE DE TERRASSE |  | 2 | 28x120 | 1800 |
| GL8 | DISTANCE SPACERS FOR GABLE MOULDING - DACHSTÜZEN - SUPPORTS EXTENSION TOITURE |  | 2 | 44x95 | 300 |
| GL | GABLE MOULDING - GIEBELLEISTE - PLANCHE DE RIVE |  | 4 | 18x120 | 4607 |
| KL4 | LENGTHENING BOLT FOR TREADED ROD - VERLÄNGERUNGSMUTTER FÜR GEWINDESTANGE - MANCHON DE RACCORDEMENT DE TIGE FILETÉE |  | 4 | | |
| KL1 | DRIVE NUT TREADED ROD - EINSHLAGMUTTER FÜR GEWINDESTANGE - ÉCROU A FRAPPER POUR TIGE FILETÉE |  | 4 | | |
| KL2 | NUT FOR TREADED ROD - MUTTER FÜR GEWINDESTANGE - ÉCROU POUR TIGE FILETÉE |  | 4 | | |
| KL3 | PLAIN WASHER TREADED ROD - UNTERLEGSCHIEBE FÜR GEWINDESTANGE - RONDELLE PLATE POUR TIGE FILETÉE |  | 4 | | |
| HS84 | SCREW FOR FIXING FILLET - SCHRAUBEN FÜR FIXIRUNGSLEISTE - VIS POUR PROFIL DE FIXATION |  | 10 | 3.5x50 | |
| HS16 | SCREW FOR GABLE MOULDING - SCHRAUBEN FÜR GIEBELLEISTE - VIS DE FIXATION POUR PLANCHE DE RIVE |  | 40 | 3.5x50 | |
| HS57 | SCREW FOR FIXING TERRACE RAILING - SCHRAUBE FÜR TERRASSE - VIS DE FIXATION DE GARDE-CORPS DE TERRASSE |  | 18 | 4.5x80 | |
| HS45 | SCREW FOR SLIDING WALL TIE - SCHRAUBEN FÜR WAND SCHIEBEREGLER - VIS POUR FIXATION ÉQUERRE MÉTALLIQUE AU PARAVENT |  | 8 | 4x20 | |
| HS32 | SCREW FOR EAVES BOARDS - SCHRAUBEN FÜR TRAUFBRETT - VIS DE FIXATION POUR BANDEAU DE TOIT |  | 48 | 4x40 | |
| HS26 | SCREW FOR ROOF EDGE REINFORCEMENT - SCHRAUBEN FÜR DACHRANDVERSTÄRKUNG - VIS POUR RENFORT DE BORD DE TOIT |  | 36 | 4x40 | |
| HS34 | SCREW FOR POST - SCHRAUBEN FÜR PFOSTEN - VIS DE FIXATION DES POTEAUX |  | 8 | 4x60 | |
| HS30 | SCREW FOR TERRACE REAR BOARDS - SCHRAUBEN FÜR TERRASSEN RAND - VIS DE FIXATION POUR MAIN COURANTE DE TERRASSE |  | 18 | 4x60 | |
| HS40 | SCREW FOR 1. WALL BEAM - SCHRAUBE FÜR 1. BOHLENREIHE - VIS DE FIXATION DES FONDATIONS |  | 6 | 5x120 | |
| HS39 | SCREW FOR FUNDAMENT - SCHRAUBEN ZUR BEFESTIGUNG FUNDAMENT - VIS POUR FONDATION |  | 28 | 5x120 | |
| HS42 | SCREW FOR GABLE - SCHRAUBEN FÜR GIEBEL - VIS POUR FIXATION DES PIGNONS |  | 4 | 5x120 | |
| HS43 | SCREW FOR ROOF BEAMS - SCHRAUBEN FÜR DACHBALKEN - VIS POUR PANNE DE TOIT |  | 8 | 5x120 | |
| HS65 | SCREW FOR FIXING GABLE MOULDING DISTANCE SPACERS TO THE WALL - SCHRAUBEN FÜR DACHSTÜZEN - VIS DE SUPPORTS EXTENSION TOITURE |  | 4 | 5x90 | |

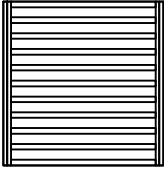
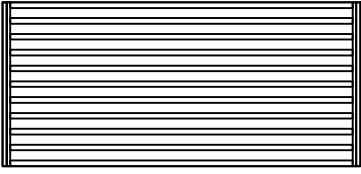
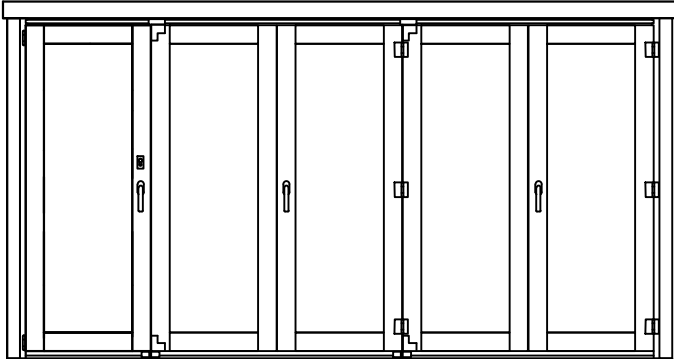
| Pos | 7016344 - Liverpool 1 Piece list - Stückliste - Liste des pieces | Q. | P (mm) | L (mm) |
|------|---|-----|-----------|-----------|
| HS49 | SCREW FOR POST HEIGHT ADJUSTMENT - SCHRAUBEN FÜR REGULIERUNGSSCHRAUBE FÜR PFOSTEN - VIS DE FIXATION DE SUPPORT RÉGLABLE DE POTEAU  | 32 | 6x50 | |
| MS | SCREW FOR DOORSTEP - SCHRAUBEN FÜR TÜRSCHWELLE - VIS DE FIXATION DU SEUIL DE PORTE  | 5 | 4.5x65 | |
| NF3 | SCREW FOR TERRACE BOARD - SCHRAUBEN FÜR TERRASSENBRETT - VIS POUR LAME DE SEUIL D'ENTREE DE TERRASSE  | 348 | 4.2x55 | |
| HS72 | SCREW FOR SLIDING WALL TIE - SCHRAUBEN FÜR WAND SCHIEBEREGLER - VIS POUR FIXATION ÉQUERRE MÉTALLIQUE AU PARAVENT  | 2 | 5x60 | |
| SH70 | HAMMER BLOCK - SCHLAGHOLZ - CALLE DE FRAPPE  | 2 | | |
| NFD | ZN NAIL FOR ROOFING FELT FILLET - ZN NÄGEL FÜR DACHPAPPENLEISTE - POINTE POUR BAGUETTE FIXATION FEUTRE BITUMEUX  | 38 | 2x40 | |
| NFF | ZN NAIL FOR FLOOR FILLETS - ZN NÄGEL FÜR FUSSBODENLEISTEN - POINTE POUR PANNEAUX DE PLANCHER  | 34 | 1.4x40 | |
| NF2 | ZN NAIL FOR ROOF - ZN NÄGEL FÜR DACHBRETT - POINTE POUR TOIT  | 497 | 2.1x50 | |
| NH1 | ZN NAIL FOR FLOOR - ZN NÄGEL FÜR FUSSBODENBRETT - CLOUS POUR PLANCHER  | 366 | 2.1x50 | |
| ORZ | MONTAGE SET FOR DOORS AND WINDOWS - MONTAGE-SET FÜR TÜREN UND FENSTER - JEU DE MONTAGE PORTES ET FENETRES | 1 | | |
| KL5 | PLAIN WASHER FOR SLIDING WALL TIE - UNTERLEGSCHIEBE FÜR WAND SCHIEBEREGLER - RONDELLE POUR SABOT MÉTALLIQUE  | 2 | | |
| WLGR | SLIDING WALL TIE - SCHIEBEREGLER FÜR WAND - EQUERRE MÉTALLIQUE DE FIXATION DU PARAVENT  | 2 | | |
| RFP | POST HEIGHT ADJUSTMENT - REGULIERUNGSSCHRAUBE FÜR PFOSTEN - SUPPORT RÉGLABLE DE POTEAU  | 4 | | |
| TRR1 | TERRACE RAILING - TERRASSE - GARDE-CORPS DE TERRASSE  | 2 | | 805 |
| TRR2 | TERRACE RAILING - TERRASSE - GARDE-CORPS DE TERRASSE  | 2 | | 1800 |
| | DOOR-TÜR-PORTE  4100X2000 3+ | 1 | | |

