

Örebro
Art.Nr.7014941

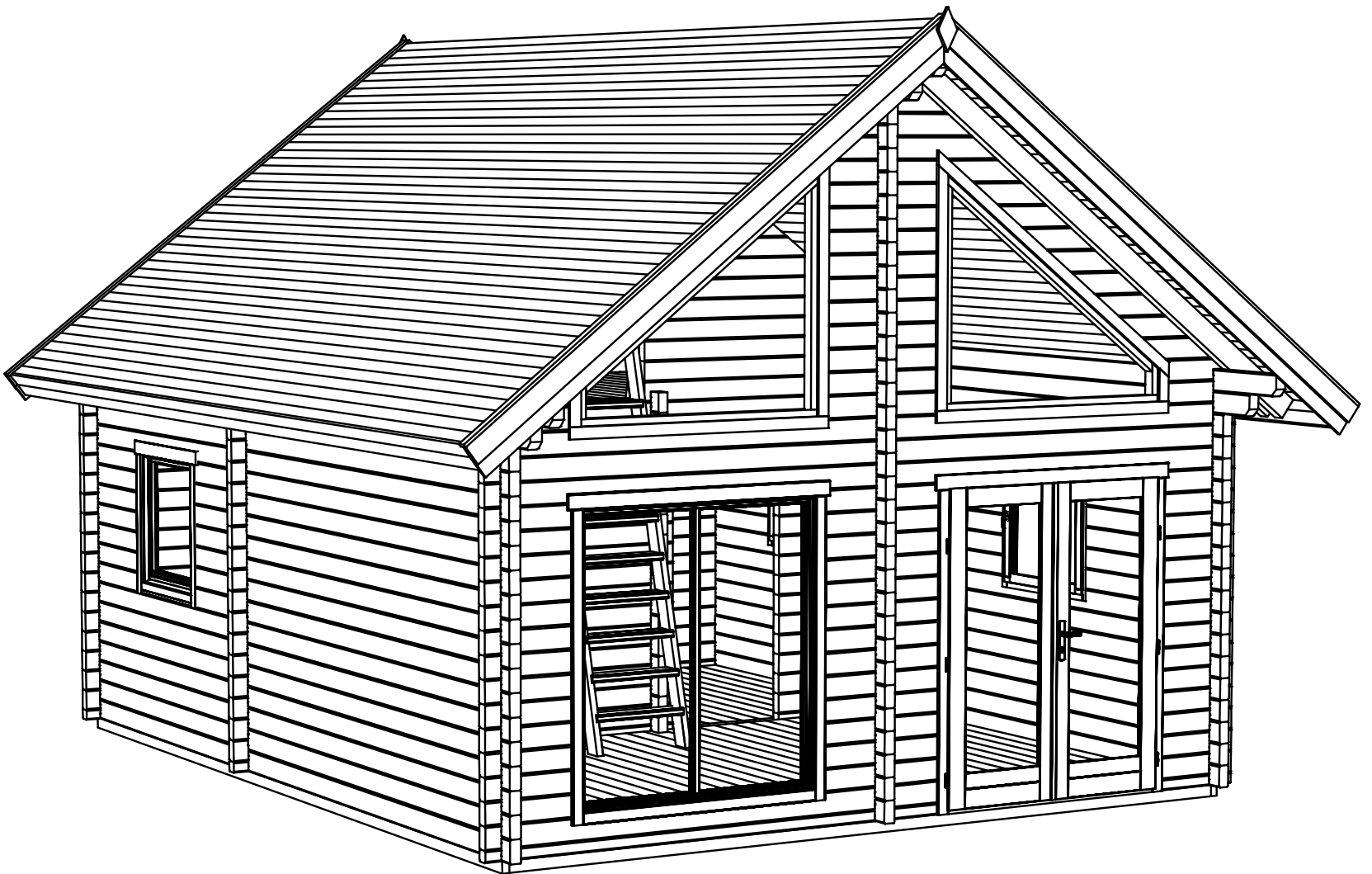

Groundplan - Grundplan - Plan de masse - Planimetria - Plattegrond - Põhiplaan

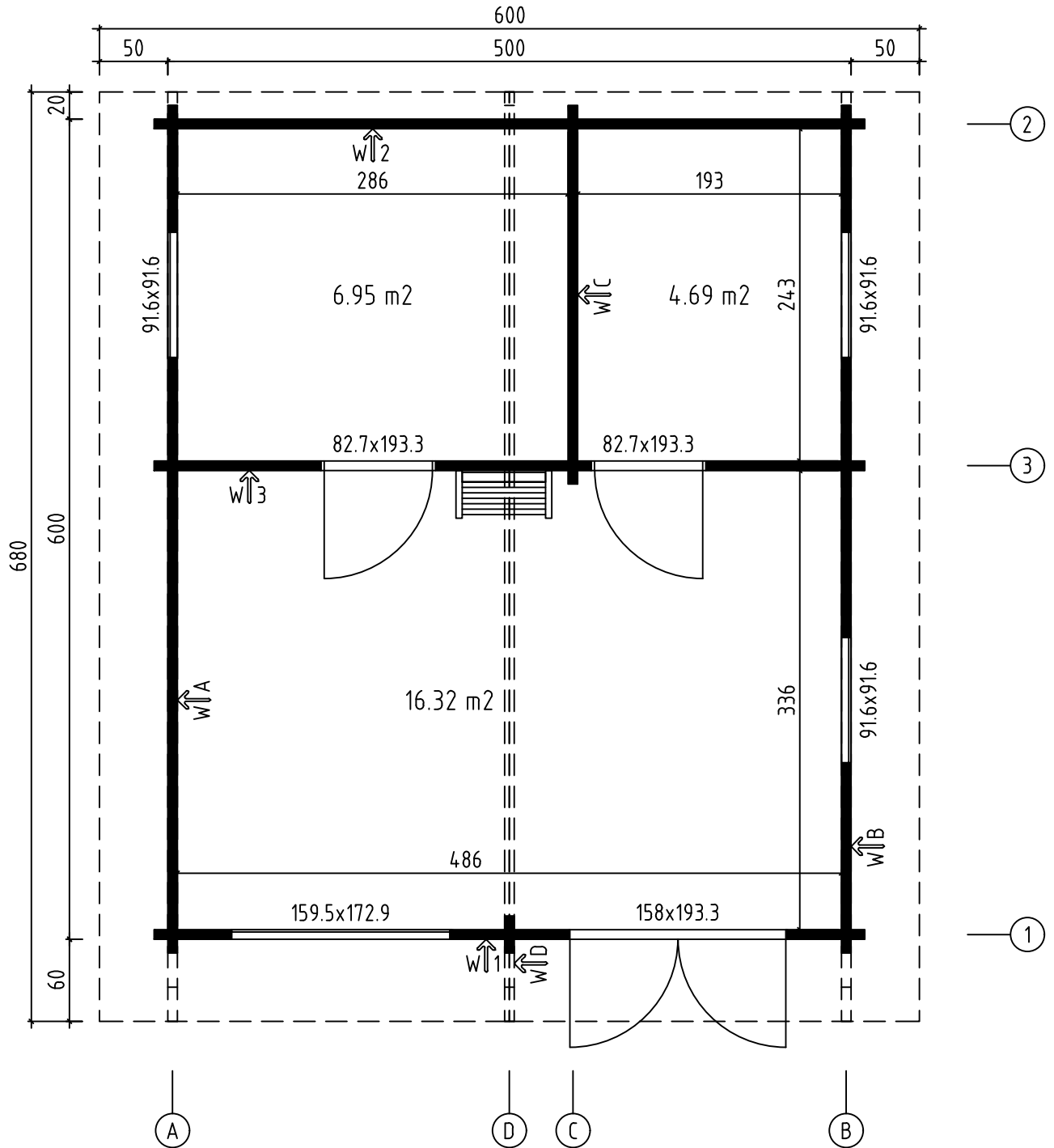

Grundplan - Grundplan - Plan de masse - Planimetria - Plattegrond -
Põhiplaan

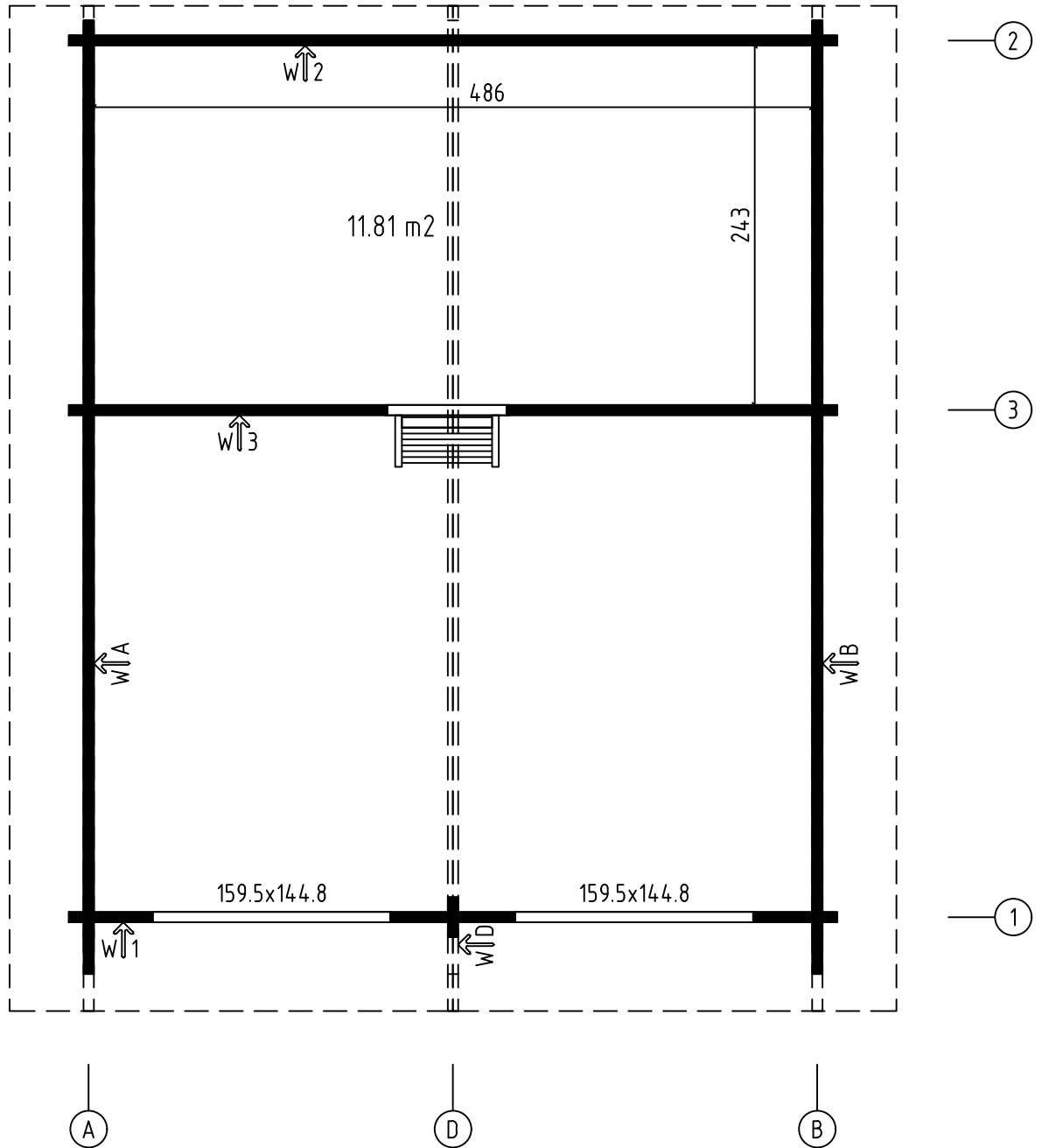

Foundation - Fundament - Fondation - Fundamenta - Fundering - Immutatud
alusraam

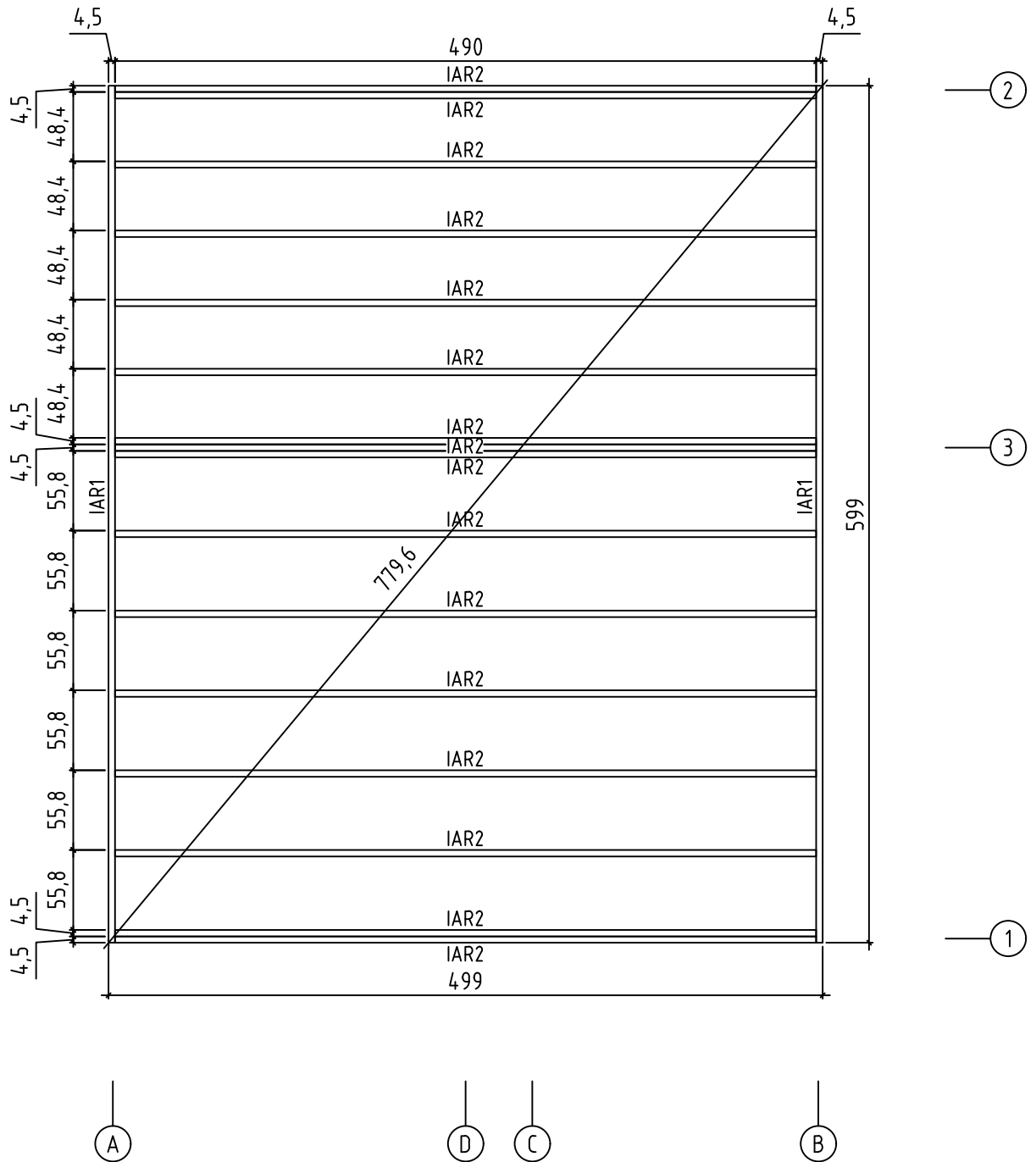

Rafters plan - Dachsparren - Plan de chevron - Piano di travi - Dak spar
constructie plattegrond - Sarikaplaan

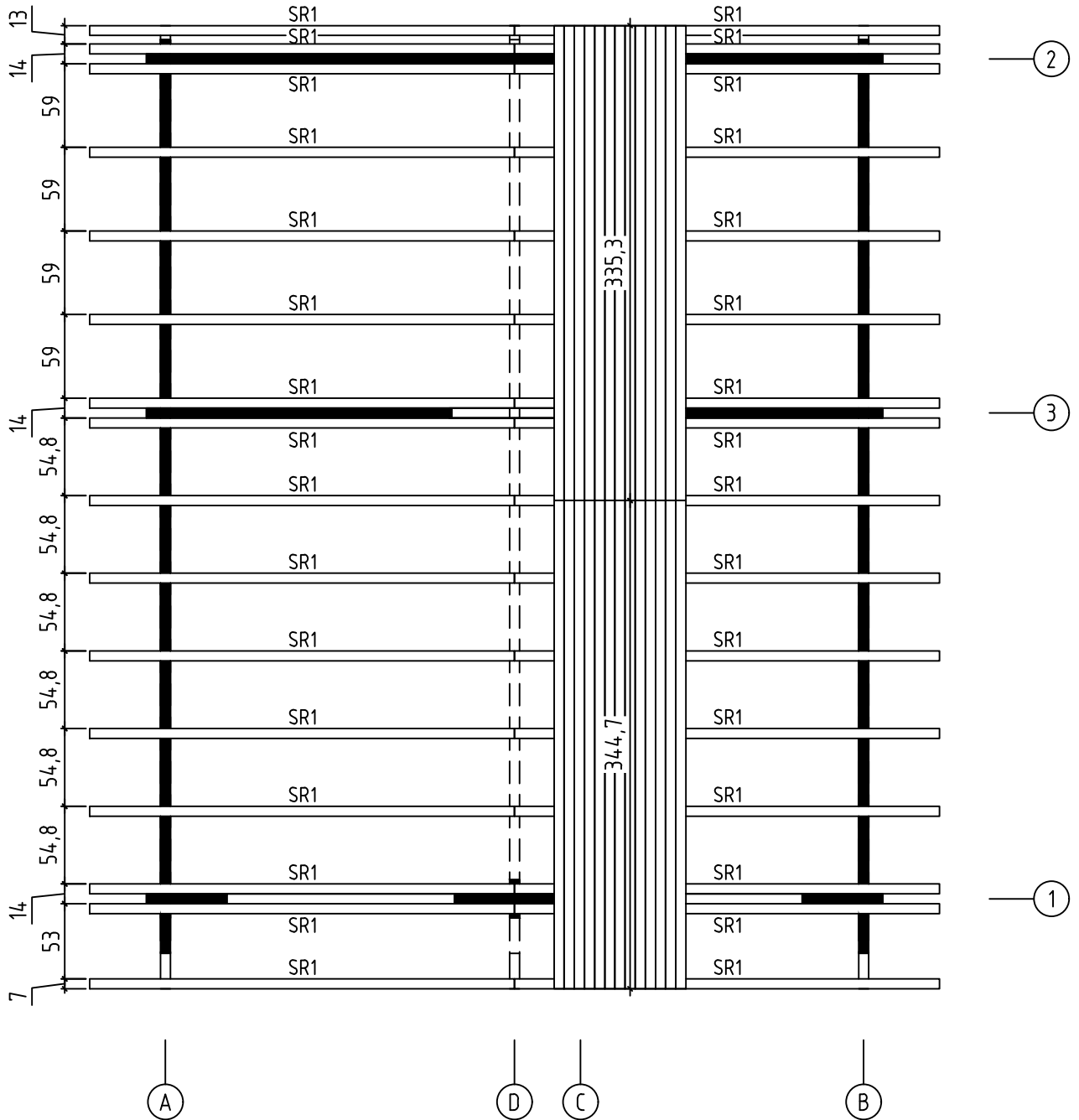

Mezzanine floor joists - Halbgeschoss balken - Solives de plancher mezzanine
- Travi del pavimento mezzanino - Plaatduim scharnier - Vahelaetalad

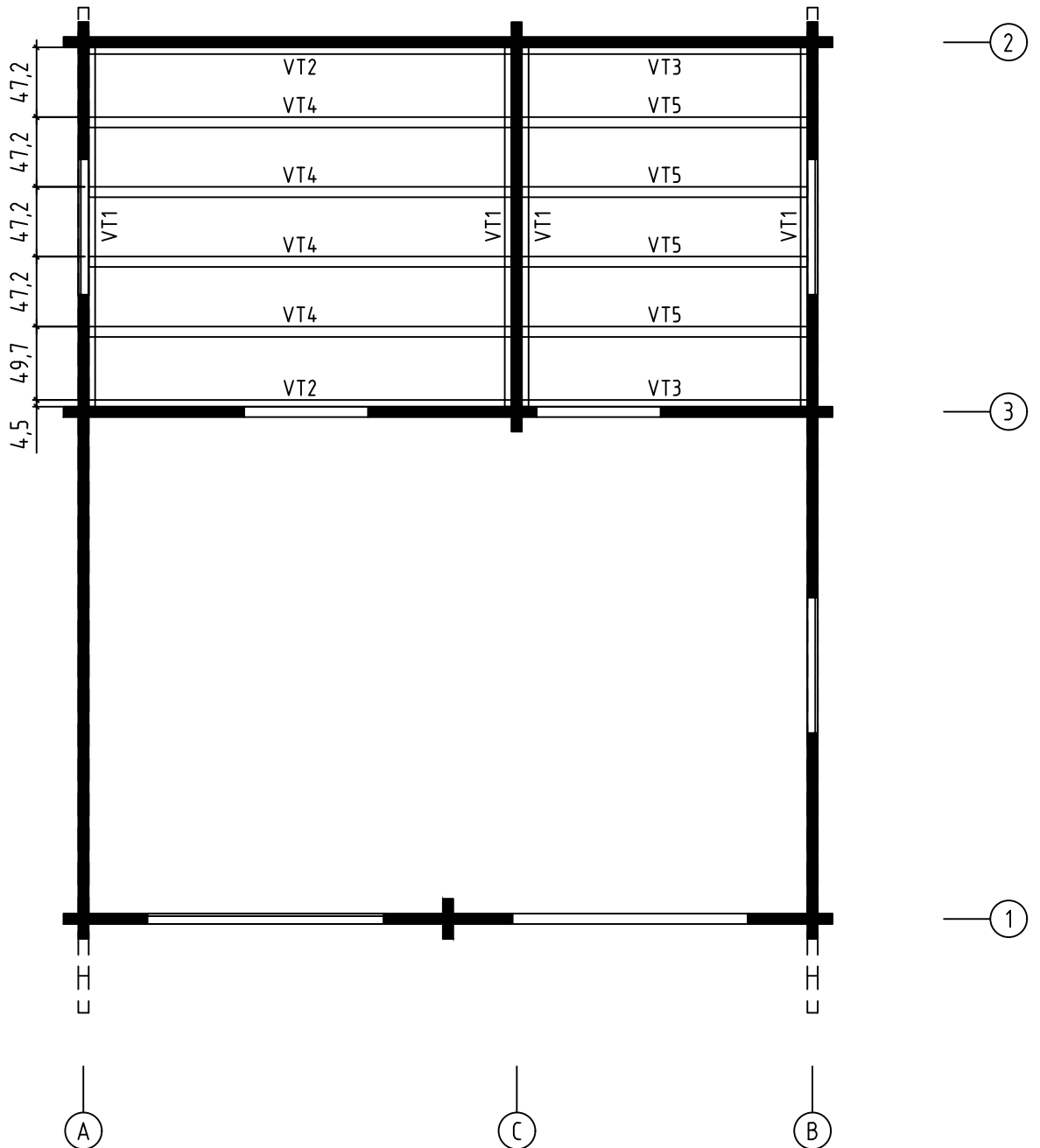

Örebrö, Art.No.7014941

Floor boards - Fussbodenbretter - Plan pose plancher - Pavimento - Vloerhout
- Põrandalaudis

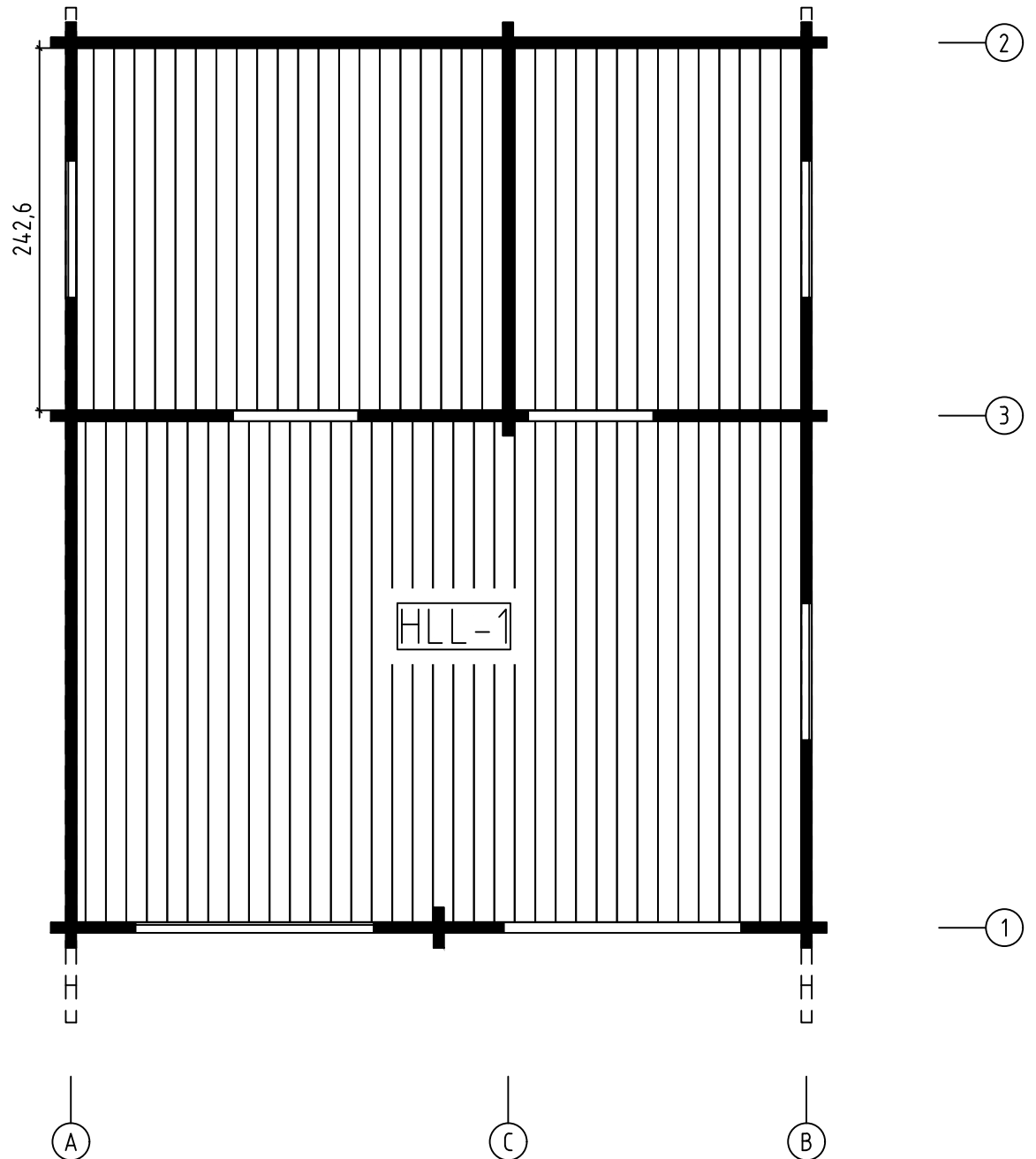

Örebrö, Art.No.7014941

Floor boards - Fussbodenbretter - Plan pose plancher - Pavimento - Vloerhout
- Põrandalaudis

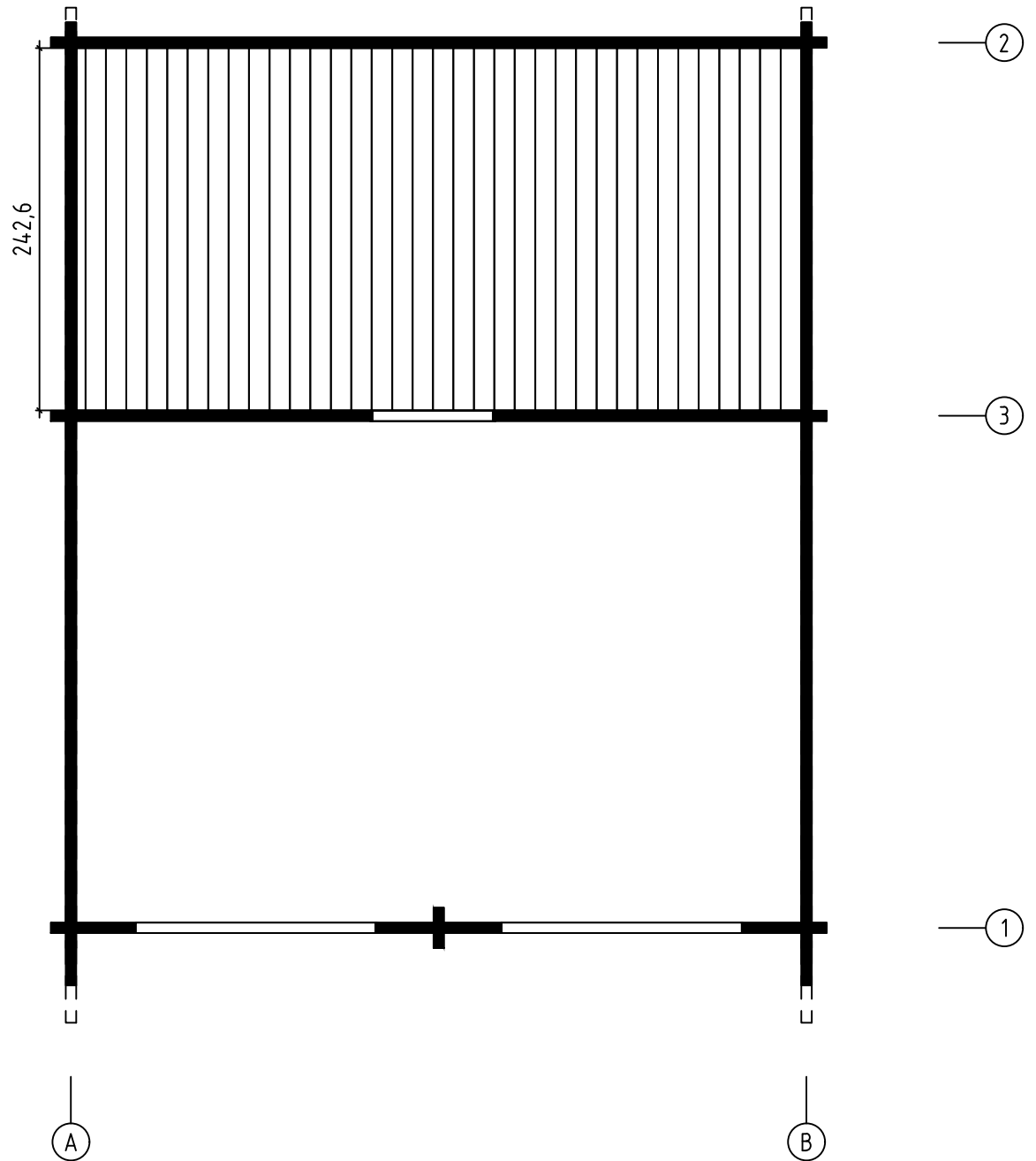

Örebro, Art.No.7014941

Ceiling boards - Deckenbrett - Voliges sous plafond - Tavole per piano soffitto
- Dakhout - Laelaud

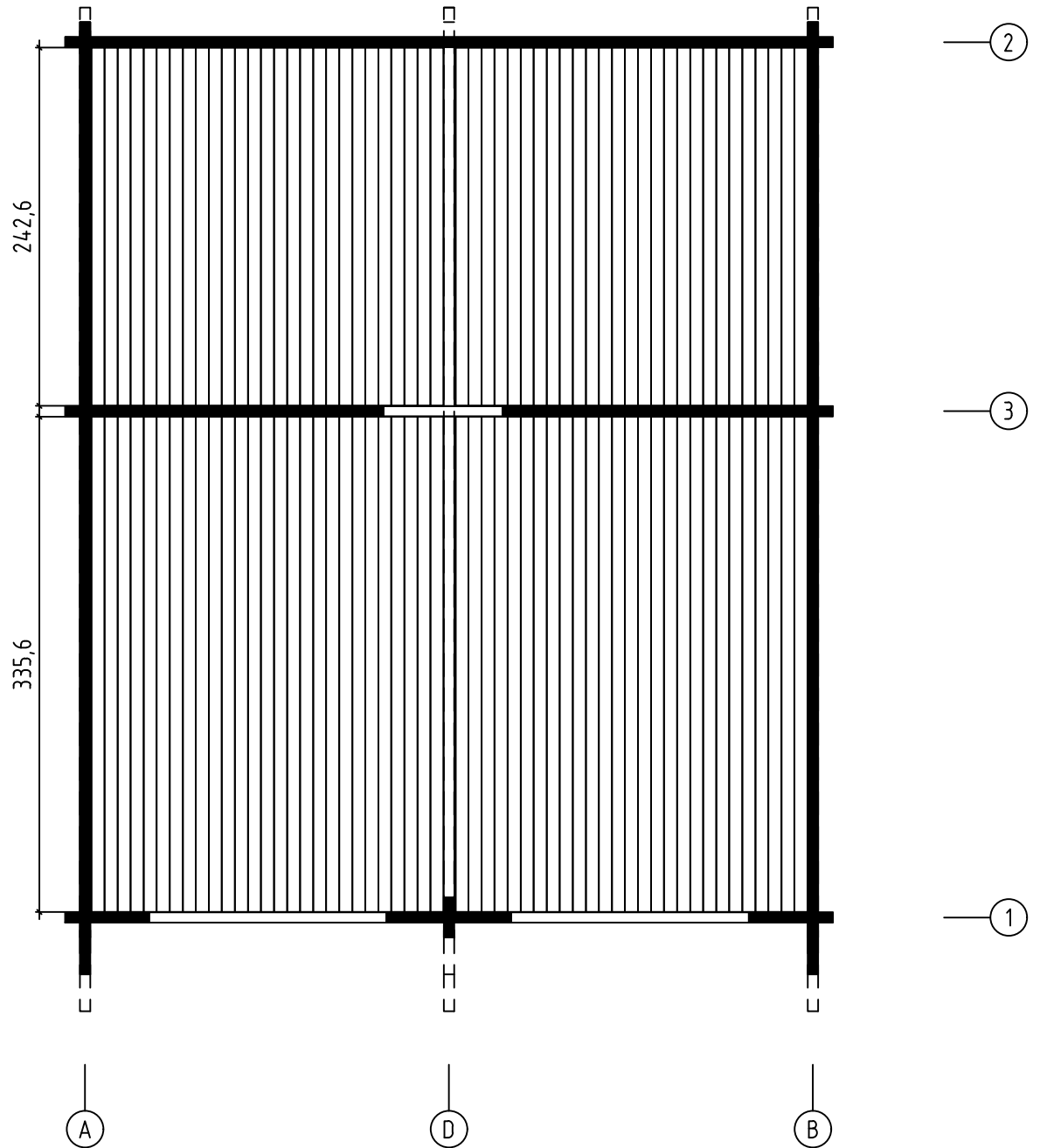

Örebrö, Art.No.7014941

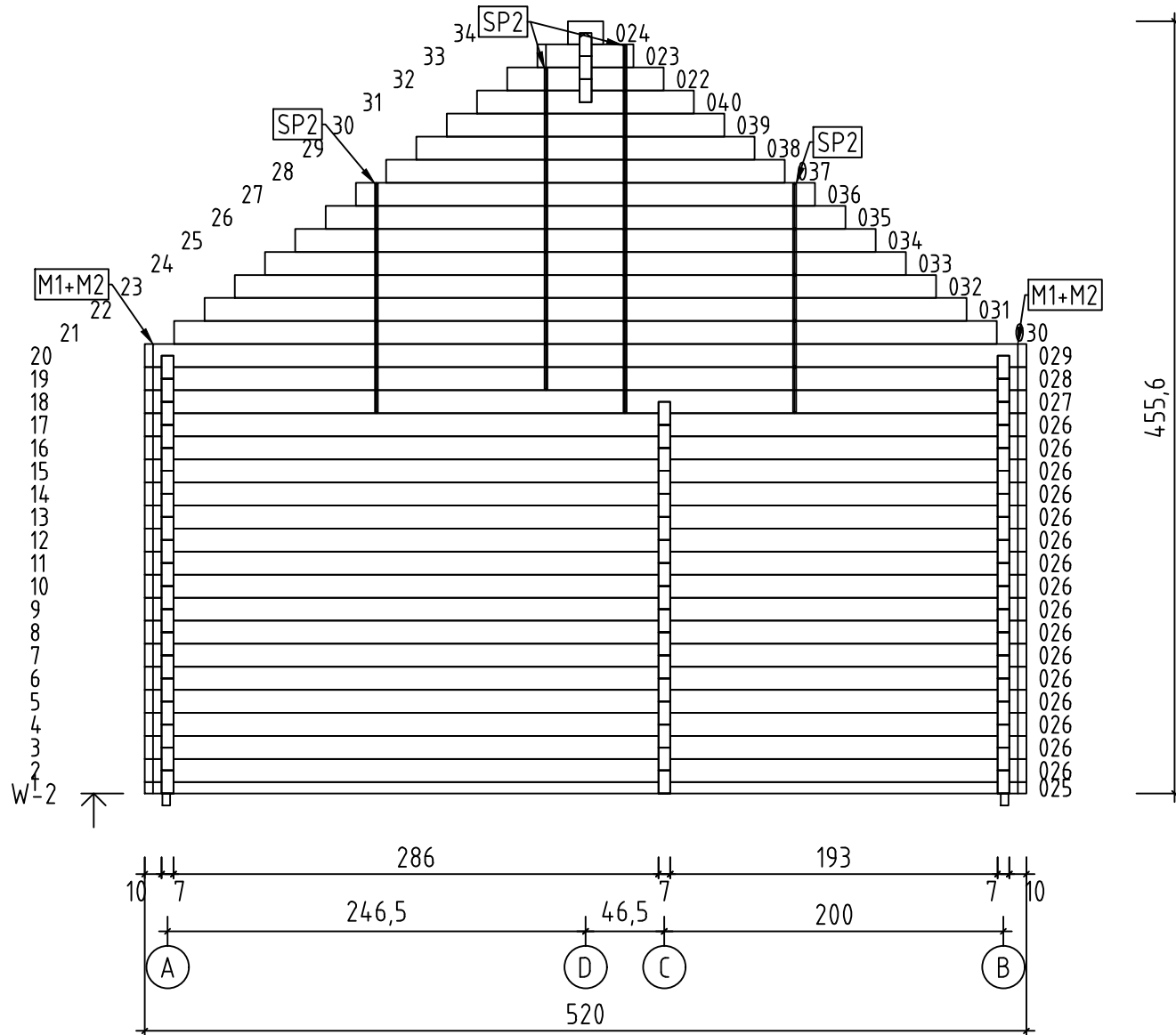

Örebro, Art.No.7014941

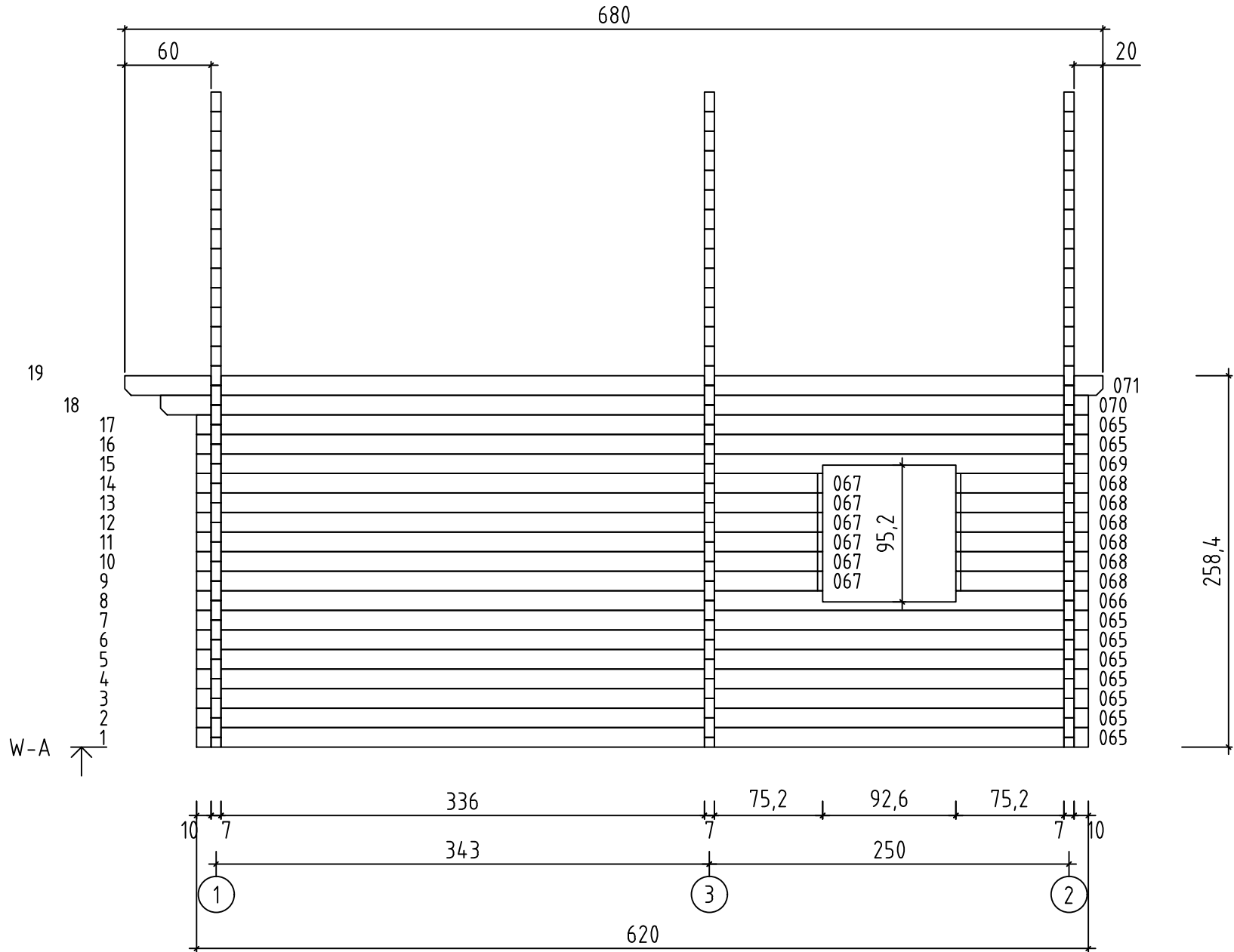

Örebro, Art.No.7014941

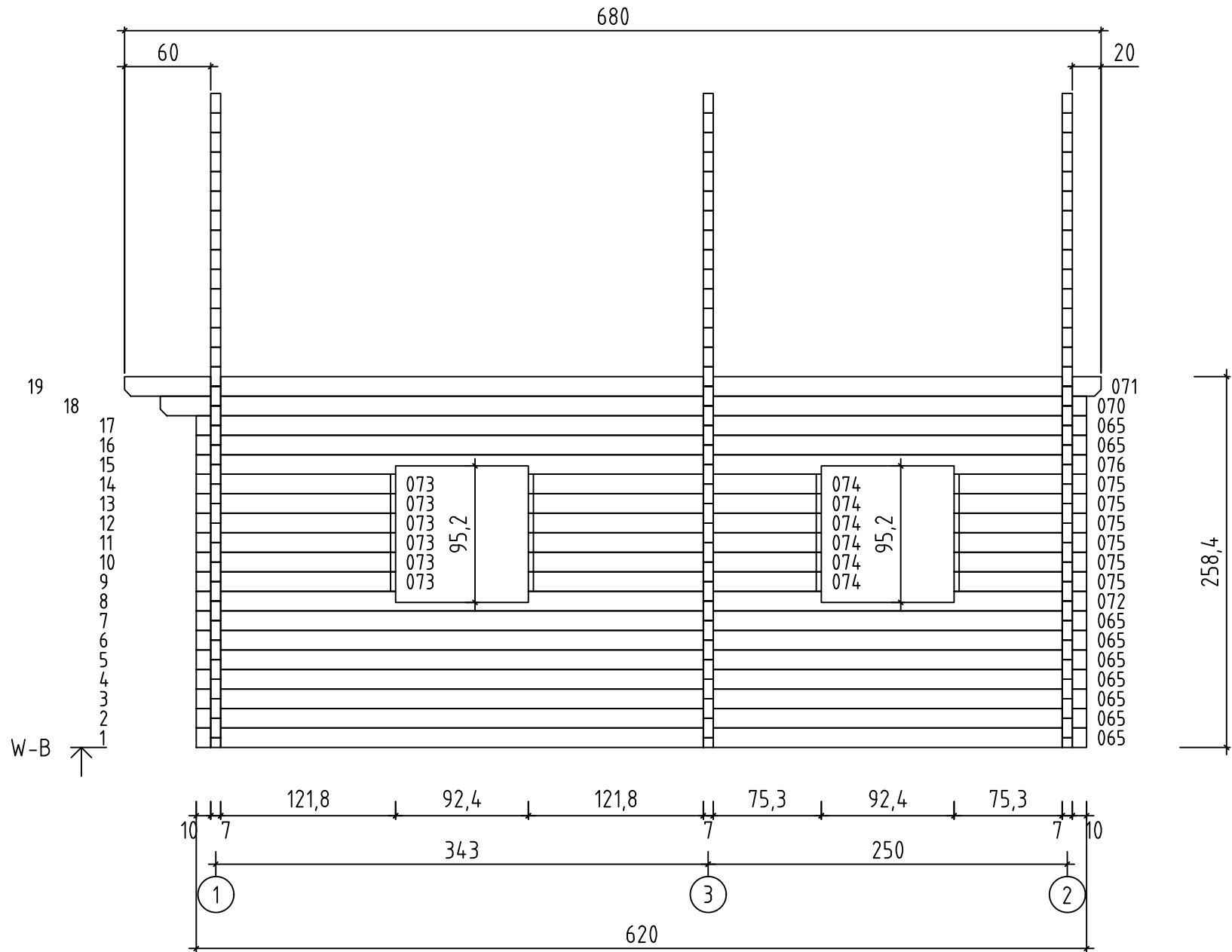

Örebro, Art.No.7014941

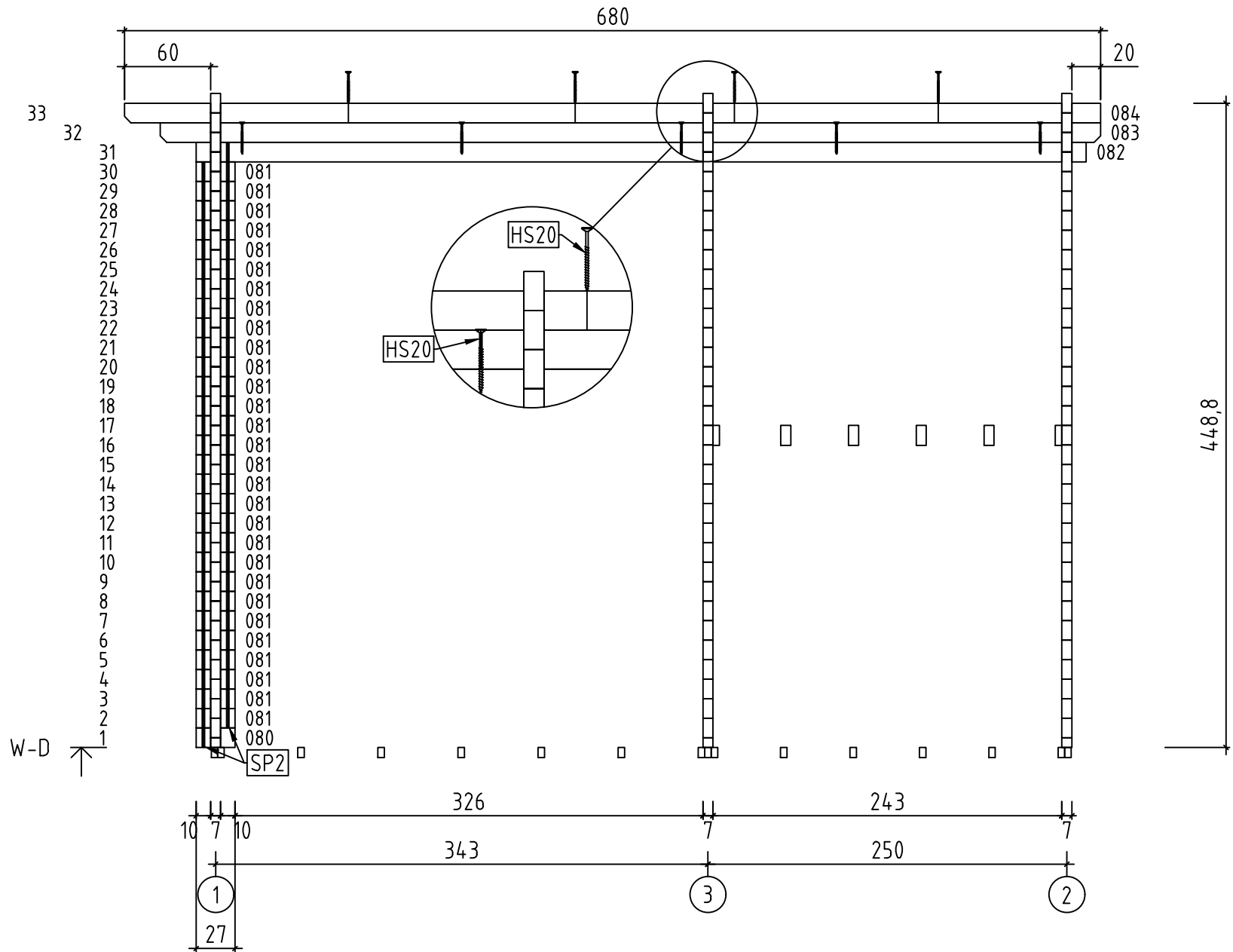



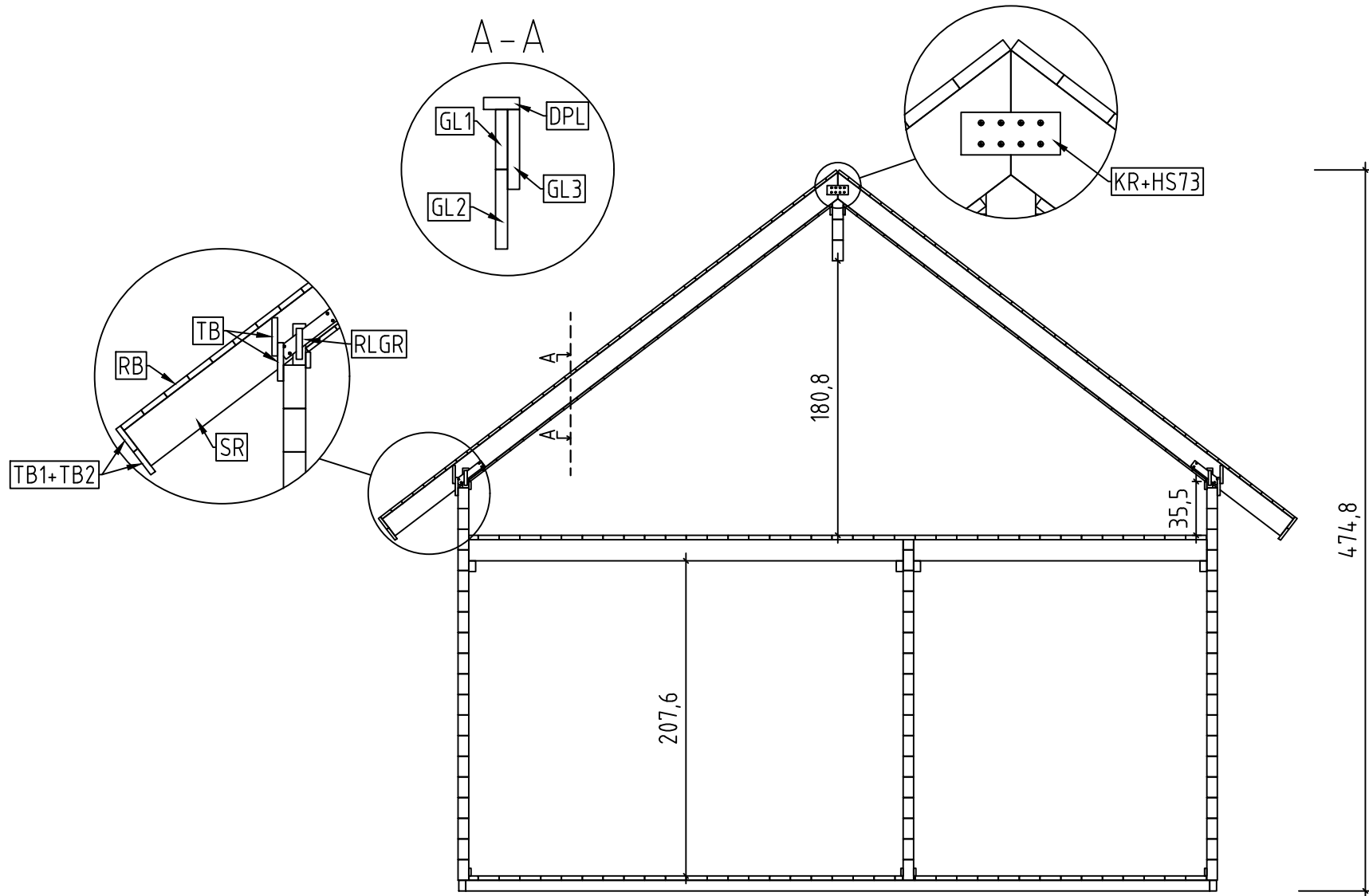





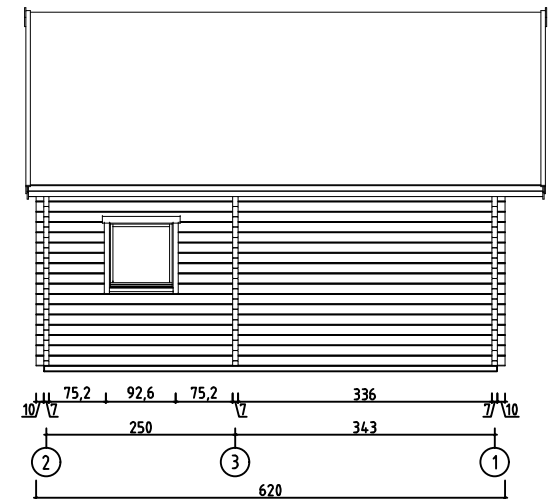
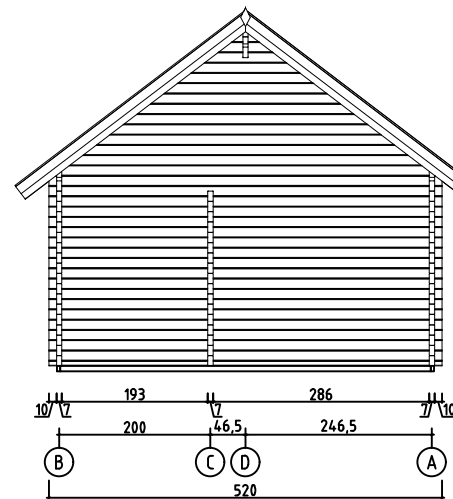
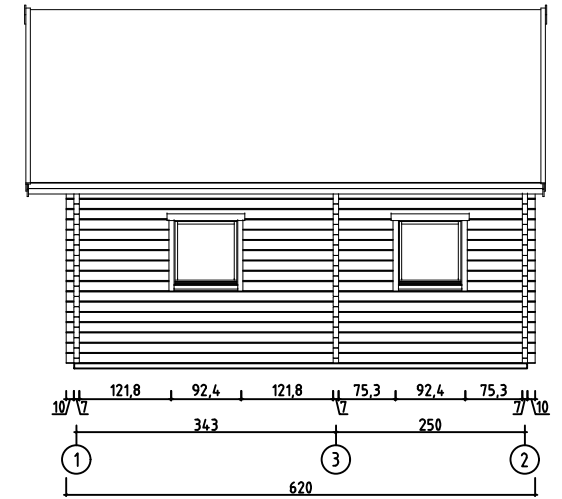
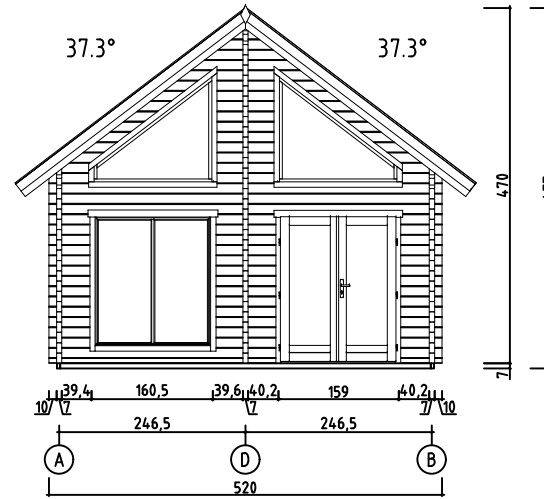
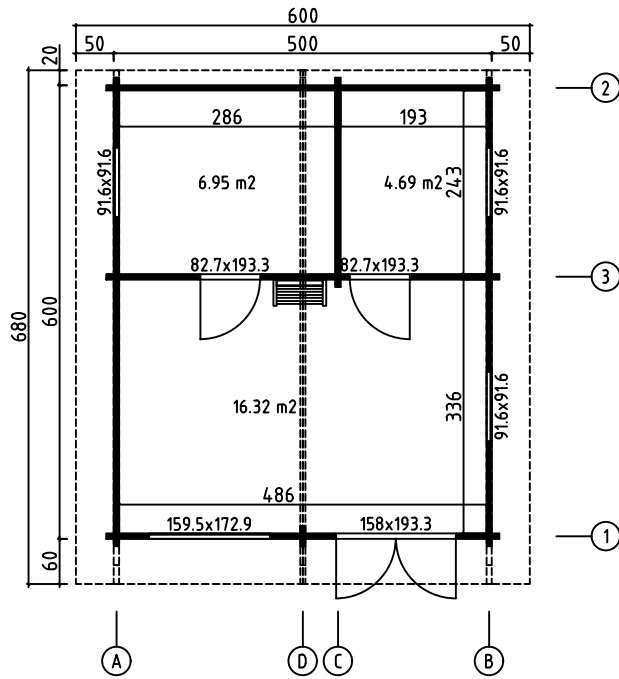

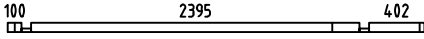

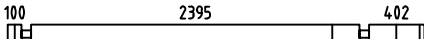

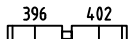
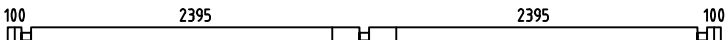

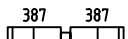

Örebro, Art.No.7014941



Art. Nr. 7014941



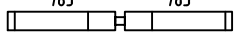
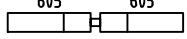
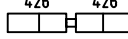



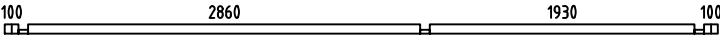
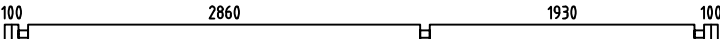
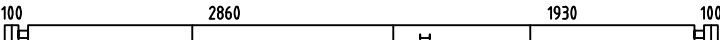
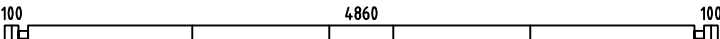
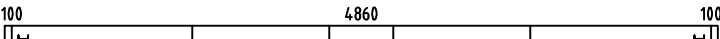
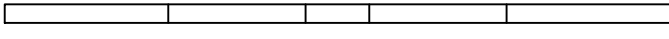
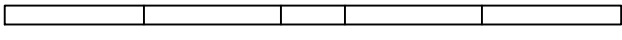
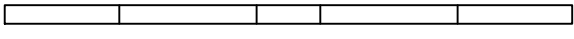
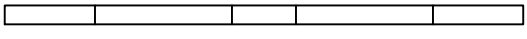
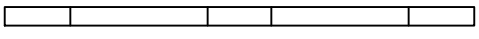
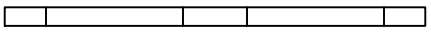
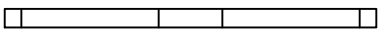
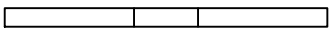
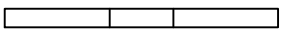
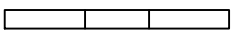
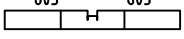
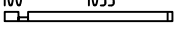
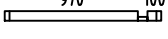
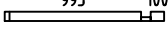
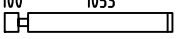
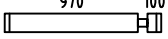
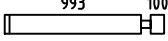

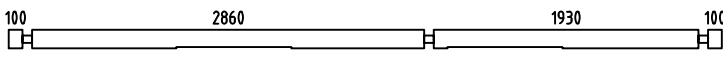
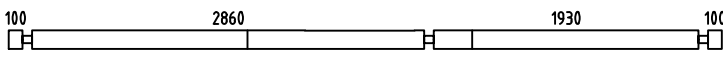
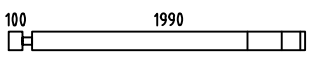
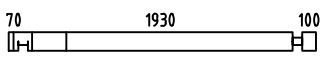
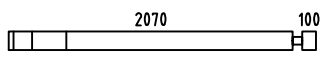
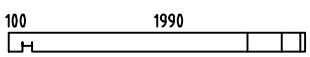
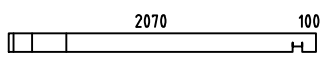
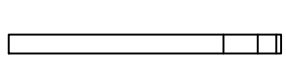
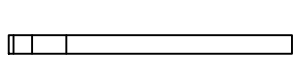
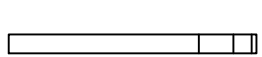
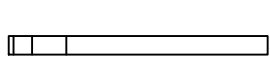
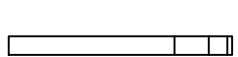
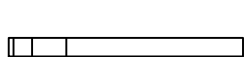
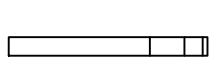
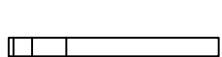
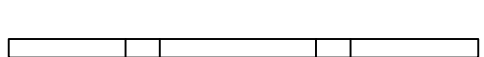
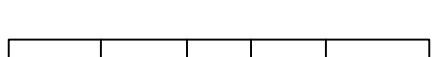
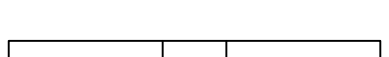
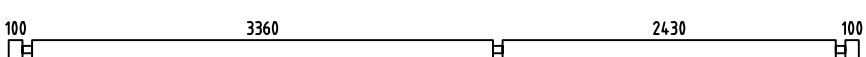
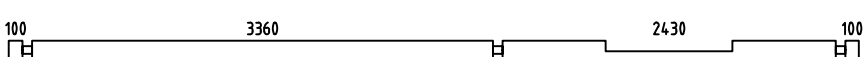
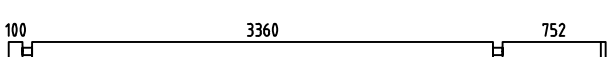
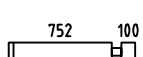
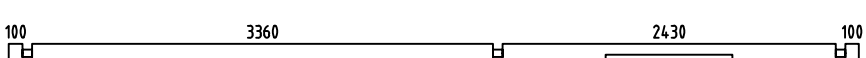
1:100

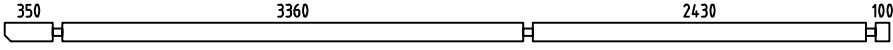
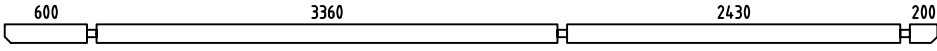
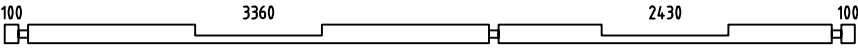
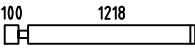
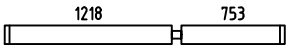
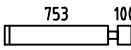
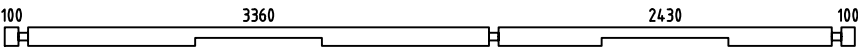
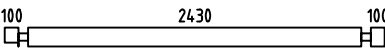
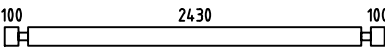
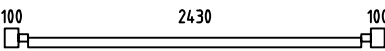

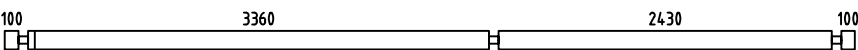
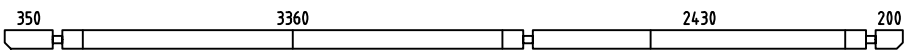
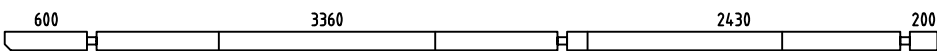

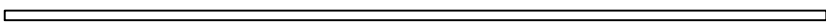
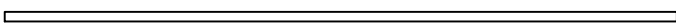

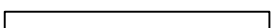
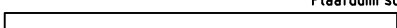

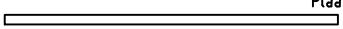





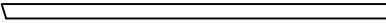

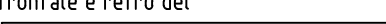



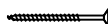

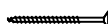
Pos	Örebrö, Art.No.7014941 Piece list - Stückliste - Liste des pièces - Elementi - Stuklijst - Tükítabel	Q	P (mm)	L (mm)
001		1	70x68	3038
002		1	70x68	573
003		1	70x136	3038
004		14	70x136	573
005		13	70x136	564
006		13	70x136	869
007		3	70x136	5200
008		2	70x136	570
009		11	70x136	844
010		2	70x136	570
011		2	70x136	574
012		2	70x136	574
013		2	70x136	574
014		2	70x136	574
015		2	70x136	574
016		2	70x136	574
017		2	70x136	574
018		2	70x136	574
019		2	70x136	574
020		1	70x136	1637
021		1	70x136	1280
022		3	70x136	923
023		3	70x136	565





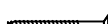



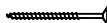
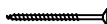

Pos	Örebrö, Art.No.7014941 Piece list - Stückliste - Liste des pièces - Elementi - Stuklijst - Tükítabel	Q	P (mm)	L (mm)
024	6969 	3	70x136	208
025		1	70x68	5200
026		16	70x136	5200
027		1	70x136	5200
028		1	70x136	5200
029		1	70x136	5200
030		1	70x136	4851
031		1	70x136	4494
032		1	70x136	4137
033		1	70x136	3780
034		1	70x136	3423
035		1	70x136	3065
036		1	70x136	2708
037		2	70x136	2351
038		2	70x136	1994
039		2	70x136	1637
040		2	70x136	1280
041		1	70x68	1223
042		1	70x68	1140
043		1	70x68	1163
044		14	70x136	1223
045		14	70x136	1140
046		14	70x136	1163

Pos	Örebrö, Art.No.7014941 Piece list - Stückliste - Liste des pièces - Elementi - Stuklijst - Tükítabel	Q	P (mm)	L (mm)
047		1	70x136	5200
048		1	70x136	5200
049		2	70x136	2160
050		1	70x136	2240
051		1	70x136	2240
052		1	70x136	2160
053		1	70x136	2240
054		1	70x136	1986
055		1	70x136	2066
056		1	70x136	1807
057		1	70x136	1887
058		1	70x136	1628
059		1	70x136	1708
060		1	70x136	1450
061		1	70x136	1530
062		1	70x136	3423
063		1	70x136	3065
064		1	70x136	2708
065		18	70x136	6200
066		1	70x136	6200
067		6	70x136	4352
068		6	70x136	922
069		1	70x136	6200

Pos	Örebrö, Art.No.7014941 Piece list - Stückliste - Liste des pièces - Elementi - Stuklijst - Tükítabel	Q	P (mm)	L (mm)
070		2	70x136	6450
071		2	70x136	6800
072		1	70x136	6200
073		6	70x136	1388
074		6	70x136	2041
075		6	70x136	923
076		1	70x136	6200
077		1	70x136	2770
078		15	70x136	2770
079		1	70x136	2770
080		1	70x136	270
081		29	70x136	270
082		1	70x136	6200
083		1	70x136	6550
084		1	70x136	6800
085		2	70x10	837
IAR1	Foundation - Fundament - Fondation - Fondamenta - Fundering - Immutatud alusraam 	2	45x70	5990
IAR2	Foundation - Fundament - Fondation - Fondamenta - Fundering - Immutatud alusraam 	16	45x70	4900
VT4	Mezzanine floor joists - Halbgeschoss balken - Solives de plancher mezzanine - Travi del pavimento mezzanino - Plaatduim scharnier - Vahelaetalad 	4	70x140	2860
VT5	Mezzanine floor joists - Halbgeschoss balken - Solives de plancher mezzanine - Travi del pavimento mezzanino - Plaatduim scharnier - Vahelaetalad 	4	70x140	1930
VT2	Mezzanine floor joists - Halbgeschoss balken - Solives de plancher mezzanine - Travi del pavimento mezzanino - Plaatduim scharnier - Vahelaetalad 	2	45x140	2860
VT3	Mezzanine floor joists - Halbgeschoss balken - Solives de plancher mezzanine - Travi del pavimento mezzanino - Plaatduim scharnier - Vahelaetalad 	2	45x140	1930
VT1	Mezzanine floor joists - Halbgeschoss balken - Solives de plancher mezzanine - Travi del pavimento mezzanino - Plaatduim scharnier - Vahelaetalad 	4	45x70	2430

Pos	Örebrö, Art.No.7014941 Piece list - Stückliste - Liste des pièces - Elementi - Stuklijst - Tükítabel	Q	P (mm)	L (mm)
SR1	Rafter - Dachsparren - Chevron - Trave - Dak spar - Sarikas 	32	70x140	3771
STP-1	Ceiling boards - Deckenbrett - Voliges sous plafond - Tavole per piano soffitto - Dakhout - Laelaud 	56	111x14	3356
STP-2	Ceiling boards - Deckenbrett - Voliges sous plafond - Tavole per piano soffitto - Dakhout - Laelaud 	56	111x14	2426
HLL-1	Floor boards - Fussbodenbretter - Lame de plancher - Pavimento - Vloerhout - Pörandalaud 		137x28	132 m.
HLL-2	Floor boards - Fussbodenbretter - Lame de plancher - Pavimento - Vloerhout - Pörandalaud 	72	137x28	2426
RB-1	Roof boards - Dachbretter - Voliges - Perlina per tetto - Dakhout - Katuselaud 	84	90x18	3447
RB-2	Roof boards - Dachbretter - Voliges - Perlina per tetto - Dakhout - Katuselaud 	84	90x18	3353
LL-1	Ceiling fillet - Deckeleiste - Profil de finition sous plafond - Massello per soffitto - Dak afdeklijst - Laeliist 		15x40	48 m.
FL-1	Floor fillet - Fussbodenleiste - Corniere de finition du plancher - Finitura per pavimento (battisco pa) - Vloerafwerklijs - Pörandaliist 		15x40	51 m.
KLS	Batten - Deckleiste - Profils de finition angles a l'exterieur - Asse - Afdek lijst - Katteliist 	2	18x70	896
DPL	Roofing felt fillet - Dachpappenleiste - Baguette de fixation du feutre bitumeux - Asse per fissaggio guaina bituminosa - Afdeklijst asfaltpapier - Katusepaliist 	4	18x58	3820
M1	Treaded rod m12 - Gewindestange m12 - Tige filetée m12 - Barra filettata passo m12 - Draadstang 12m - Keermelatt 	4		700
M2	Treaded rod m12 - Gewindestange m12 - Tige filetée m12 - Barra filettata passo m12 - Draadstang 12m - Keermelatt 	4		2000
SWE	Doorstep - Swelle - Seuil de porte - Callare - DrempeL - Lävepak ukseavale 	1	28x72	800
TB	Fascia board - Traufbrett - Bandeau de toit - Finitura lati tetto - Gevellijst - Räästalaud 	24	18x120	478
TB	Fascia board - Traufbrett - Bandeau de toit - Finitura lati tetto - Gevellijst - Räästalaud 	16	18x120	520
TB1	Fascia board - Traufbrett - Bandeau de toit - Finitura lati tetto - Gevellijst - Räästalaud 	4	18x90	3353
TB2	Fascia board - Traufbrett - Bandeau de toit - Finitura lati tetto - Gevellijst - Räästalaud 	4	18x90	3447
AT	Fixing fillet - Fixierungsleiste - Profil de fixation - Massello di fissaggio - Bevestiging lijstwerk - Tenderliist 	2	28x34	896
TBE6-1	Fixing fillet - Fixierungsleiste - Profil de fixation - Massello di fissaggio - Bevestiging lijstwerk - Tenderliist 	2	28x34	250
TBE6-2	Fixing fillet - Fixierungsleiste - Profil de fixation - Massello di fissaggio - Bevestiging lijstwerk - Tenderliist 	6	28x34	780
TBE6-3	Fixing fillet - Fixierungsleiste - Profil de fixation - Massello di fissaggio - Bevestiging lijstwerk - Tenderliist 	2	28x34	1450
TBE6-4	Fixing fillet - Fixierungsleiste - Profil de fixation - Massello di fissaggio - Bevestiging lijstwerk - Tenderliist 	2	28x34	1729

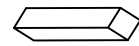
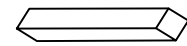
Pos	Örebrö, Art.No.7014941 Piece list - Stückliste - Liste des pièces - Elementi - Stuklijst - Tükítabel	Q	P (mm)	L (mm)
TBE6-1	Fixing fillet - Fixierungsleiste - Profil de fixation - Massello di fissaggio - Bewestiging lijstwerk - Tenderlijst 	4	28x34	1922
TBE6-2	Fixing fillet - Fixierungsleiste - Profil de fixation - Massello di fissaggio - Bewestiging lijstwerk - Tenderlijst 	2	28x34	1933
GL1	Gable moulding - Giebelleiste - Planche de rive - Finitura per frontale e retro del tetto - Gevellijst - Viilulaud 	4	18x90	3820
GL2	Gable moulding - Giebelleiste - Planche de rive - Finitura per frontale e retro del tetto - Gevellijst - Viilulaud 	4	18x120	3751
GL3	Gable moulding - Giebelleiste - Planche de rive - Finitura per frontale e retro del tetto - Gevellijst - Viilulaud 	4	18x120	3820
KL4	Lengthening bolt for threaded rod - Verlängerungsmutter für gewindestange - Manchon de raccordement de tige filetée - Bullone per barra filettata passo - Extensie moer voor draadstang - Jätkumutter keermelatile 	4		
KL1	Drive nut threaded rod - Einschlagmutter für gewindestange - Écrou a frapper pour tige filetée - Dado guida per barra filettata - Aandrijfmoer / aanslagmoer voor draadstang - Löökmutter keermelatile 	4		
KL2	Nut for threaded rod - Mutter für gewindestange - Écrou pour tige filetée - Dado per barra filettata - Moer voor draadstang - Mutter keermelatile 	4		
KL3	Plain washer threaded rod - Unterlegscheibe für gewindestange - Rondelle plate pour tige filetée - Rondella per barra filettata - Sluitring voor draadeind - Seib keermelatile 	4		
HS12	Screw for gable segment - Schrauben für deckblatt - Vis pour fixation losange de finition - Viti x frontali tetto - Schroef voor gevelpunt segment - Kruvi rombile 	4	3.5x35	
HS11	Screw for fillet - Schraube zur befestigung türleiste - Vis d'assemblage du cadre de porte - Viti per massello - Schroef voor bevestiging deurlijst - Kruvi liistule 	4	3.5x50	
HS25	Screw for floor - Schrauben für fussbodenbretter - Vis pour plancher - Viti per le perline del pavimento - Schroef voor vloerhout - Kruvi põrandale 	735	3.5x50	
HS32	Screw for fascia boards - Schrauben für traufbretter - Vis pour fixation bandeau de toit - Viti x striscia del tetto - Schroef voor gevellijst - Kruvi räästalauale 	192	3.5x50	
HS84	Screw for fixing fillet of door and window - Schrauben für fixierungsleiste - Vis pour profil vertical de fixation pour ouvertures des fenetres et portes - Viti per massello di fissaggio - Schroeven voor bevestiging van deur en raam lijsten - Kruvi tenderlijstudele 	76	3.5x50	
HS59	Screw for doorstep - Schrauben für swelle - Vis pour fixation barre de seuil - Vite per soglia della porta - Schroef voor deurdorpel - Kruvi lävepakule 	3	3.5x50	
HS16	Screw for gable moulding - Schrauben für giebelleiste - Vis pour fixation planche de rive - Vite per fissare finiture davanti e dietro del tetto - Schroef voor gevellijst - Kruvi viilulauale 	160	3.5x50	
NFD	Screw for roofing felt fillet - Schrauben für dachpappenleiste - Vis pour fixation baguette de fixation feutre bitumeux - Vite per massellino del feltro del tetto - Schroef voor asfaltpaier afdeklijst - Kruvi katusepapiiistule 	32	4x40	
HS73	Screw for nailing plate - Holzschraube für nagelplatte - Vis de fixation des cornieres en métal - Viti per fissare suadretta di metallo di giunzione - Schroef voor spijkerplaat - Kruvi naelutusplaadile 	128	4x40	
HS86	Screw for sliding wall tie - Schieberegler für wand - Sabot métallique pour fixation mur - Vite per fissare scorrimento a c su slitta fissata alla parete - Schuifdeur instellingen wand - Kruvi sarikaliugurile 	256	4x40	
HS36	Screw for stepladder - Schraube für leiter - Vis d'assemblage des marches de l'échelle - Vite per scaletta - Schroef voor trapladder - Kruvi redeli montaažiks 	36	4x60	
HS89	Screw for loft support - Schraube für dachbefestigung - Vis pour cornière de renfort de fixation - Viti per supporto del soppalco - Schroef voor dakbevestiging - Kruvi vahelae kandurliistule 	72	5x100	
HS40	Screw for 1. wall beam - Schraube für 1. bohlenreihe - Vis de fixations 1ere rangée de madriers avec poutrelles de fondations - Vite fissaggio alle fondamenta - Schroef voor 1 wandbalk - Kruvi poollauale 	14	5x120	
HS39	Screw for foundation - Schrauben zur befestigung fundament - Vis de fixations des poutrelles de fondations - Viti x fondamenta - Schroef voor fundering - Kruvi alusraamile 	40	5x90	

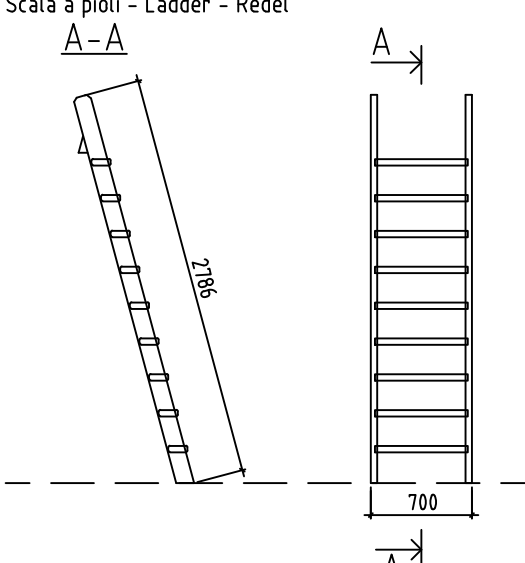
Pos	Örebrö, Art.No.7014941 Piece list - Stückliste - Liste des pièces - Elementi - Stuklijst - Tükítabel	Q	P (mm)	L (mm)
HS41	Screw for fillet - Schraube zur befestigung türleiste - Vis d'assemblage du cadre de porte - Viti per massello - Schroef voor bevestiging deurlijst - Kruvi liistule 	2	5x90	
HS44	Screw for rafter - Schrauben für dachsparren - Vis pour chevron - Vite per trave - Schroef voor dakspar - Kruvi sarikafele 	32	6x180	
HS15	Screw for wall details - Schraube für wand details - Vis pour mur details - Viti per elementi della porta - Schroef voor wand details - Kruvi seinadetailidele	20	6x180	
HS20	Screw for wall details - Schraube für wand details - Vis pour mur details - Viti per elementi della porta - Schroef voor wand details - Kruvi seinadetailidele	29	8x220	
MS	Screw for doorstep - Schrauben für swelle - Vis pour fixation barre de seuil - Vite per soglia della porta - Schroef voor deurdorpel - Kruvi lävepakule 	7	4.5x65	
SH70	Hammer block - Schlagholz - Calle de frappe - Blocco di legno da usare come cuscinetto quando si usa il martello - Slagklos - Löögiklots 	2		
NFC	Zn nail for ceiling fillet - Zn nägel deckeleiste - Pointe pour profil de finition sous plafond - Chiodi zincati per massellini del soffitto - Spijker(nagel) voor plafond afdekljst - Nael laeliistule 	96	1.4x40	
NFF	Zn nail for floor fillet - Zn nägel für fussbodenteiste - Pointe pour corniere de finition du plancher - Chiodi x fissaggio pavimento - Spijker(nagel) voor vloer afdekljst - Nael põrandaliistule 	104	1.4x40	
NF2	Zn nail for roof - Zn nägel für dachbretter - Pointe pour fixation voliges de toit - Chiodi x perline tetto - Spijker(nagel) voor dakhout - Nael katuselauale 	1376	2.1x50	
NF2	Zn nail for ceiling boards - Zn nägel für deckenbretter - Clous pour voliges sous plafonds - Chiodo per il tavolo del soffitto - Spijkers voor plafondplaat - Nael laelauale 	696	2.1x50	
KR	Nailing plate - Nagelplatte - Plaque de clouage - Piastra per inchiodare - Spijkerplaat - Naelutusplaat 	16		
ORZ	Montage set for doors and windows - Montage-set für türen und fenster - Jeu de montage portes et fenetres - Set di assemblaggio per porte e finestre - Montage set voor deur en raam - Orthez akna ja ukse montaažvahendid	1		
GS	Gable segment - Deckblatt - Losange de finition - Decorazione in legno x frontale tetto - Gevelpunt segment - Romb 	2		
SP1	Hidden fixing - Holzdübel - Tourillon bois - Fissaggio a scomparsa - Verloren kop spijker - Salapulk 	1		190
SP2	Hidden fixing - Holzdübel - Tourillon bois - Fissaggio a scomparsa - Verloren kop spijker - Salapulk 	111		260
RLGR	Sliding wall tie - Schieberegler für wand - Sabot métallique pour fixation mur - Cravatta parete scorrevole - Schuifregelaar voor wand - Seinaliugur 	32		
LR	Ladder - Leiter - Echelle - Scala a pioli - Ladder - Redel 	1		

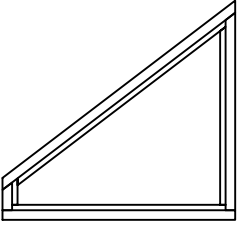
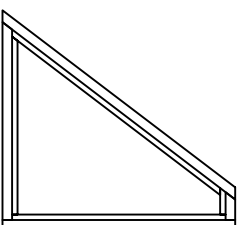
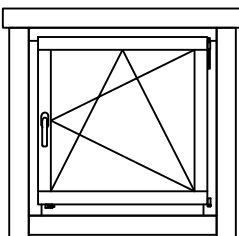
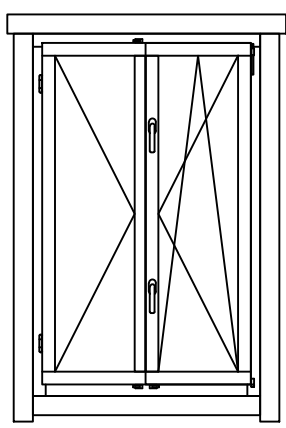
Pos	<p style="text-align: center;">Örebrö, Art.No.7014941 Piece list - Stückliste - Liste des pièces - Elementi - Stuklijst - Tükítabel</p>	Q	P (mm)	L (mm)
	<p>Window - Fenster - Fenetre - Finestra - Raam - Aken 1595x1448 2+ KA.OP.K</p> 	1		
	<p>Window - Fenster - Fenetre - Finestra - Raam - Aken 1595x1448 2+ KA.OV.K</p> 	1		
	<p>Window - Fenster - Fenetre - Finestra - Raam - Aken 916x916 2+ A.OP.K</p> 	3		
	<p>Window - Fenster - Fenetre - Finestra - Raam - Aken 1595x1729 2+ TA.OP.bK</p> 	1		

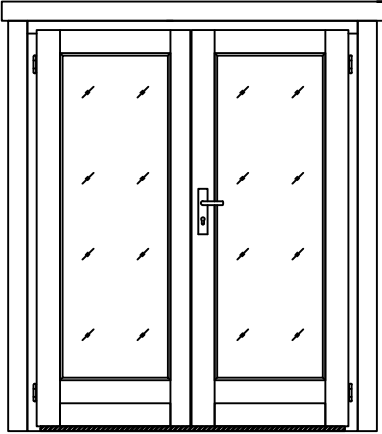
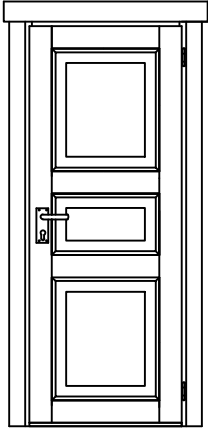
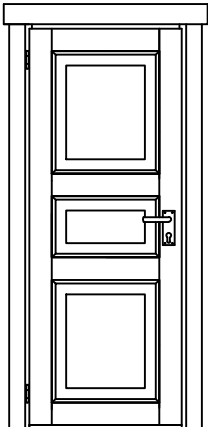
Pos	<p style="text-align: center;">Örebrö, Art.No.7014941 Piece list - Stückliste - Liste des pièces - Elementi - Stuklijst - Tükítabel</p>	Q	P (mm)	L (mm)
	<p>Door - Tür - Porte - Porte - Deur - Uks 1580x1933 2+ TU.10P.K</p> 	1		
	<p>Door - Tür - Porte - Porte - Deur - Uks 827x1933 U.3TP</p> 	1		
	<p>Door - Tür - Porte - Porte - Deur - Uks 827x1933 U.3TV</p> 	1		

