

*Aviemoire*  
*Art. Nr.7013202*

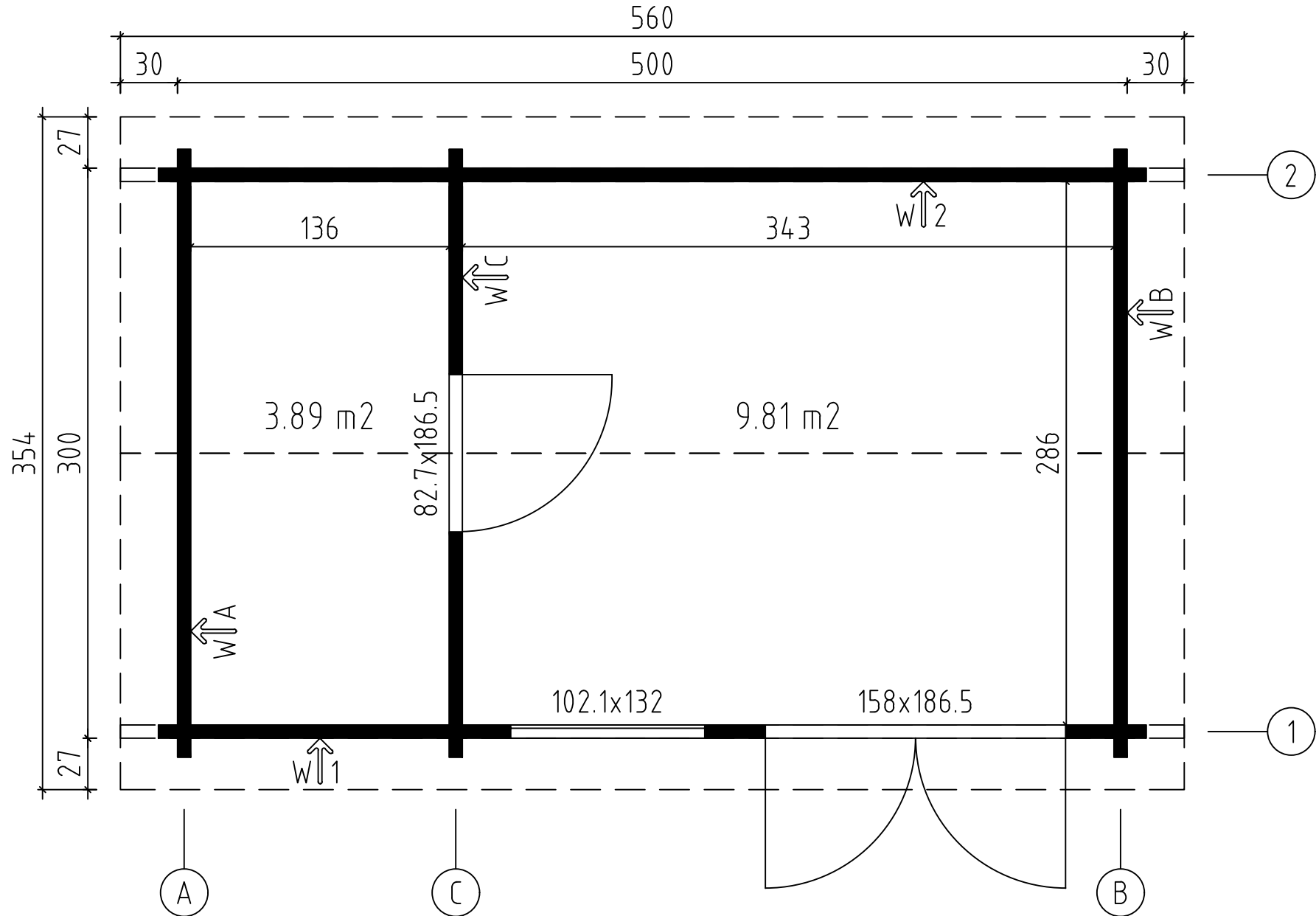

Aviemore, Art.No.7013202  
GROUNDPLAN - GRUNDPLAN - PLAN DE MASSE



Aviemore, Art.No.7013202  
FOUNDATION - FUNDAMENT - FONDAZIONE

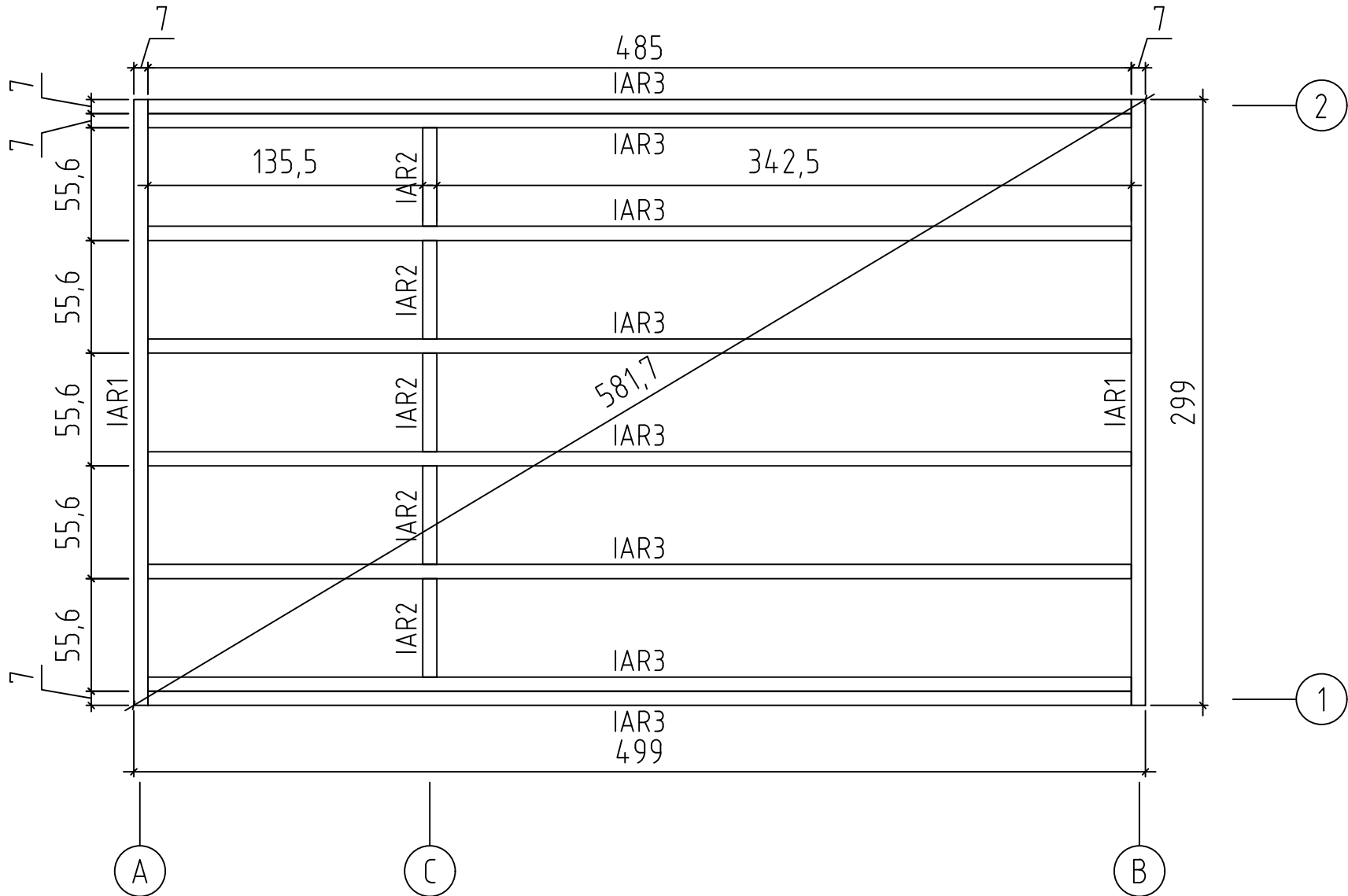

Aviemore, Art.No.7013202

FLOOR BOARDS - FUSSBODENBRETTER - PLAN POSE PLANCHER

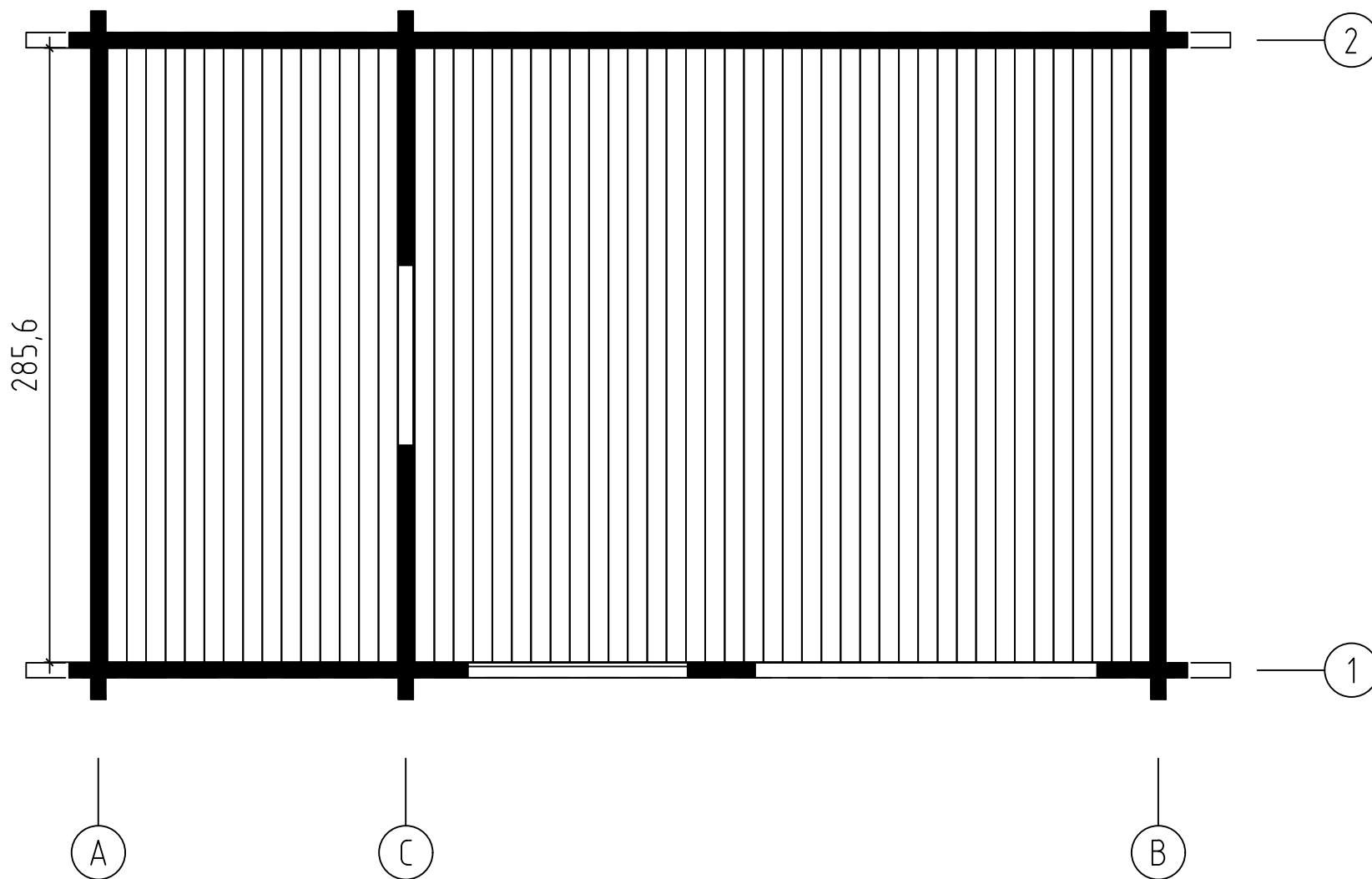



Aviemore, Art.No.7013202

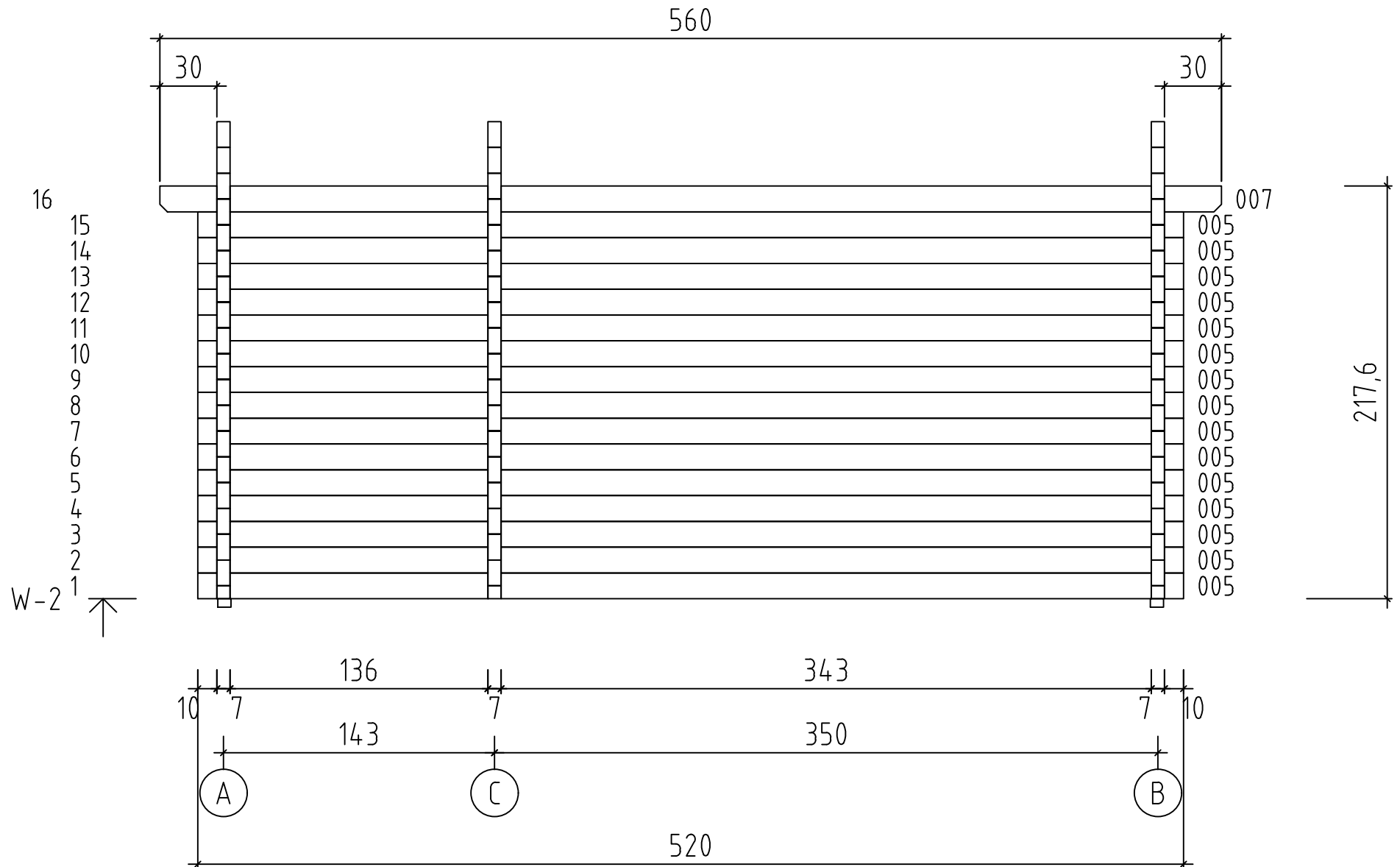

Aviemore, Art.No.7013202

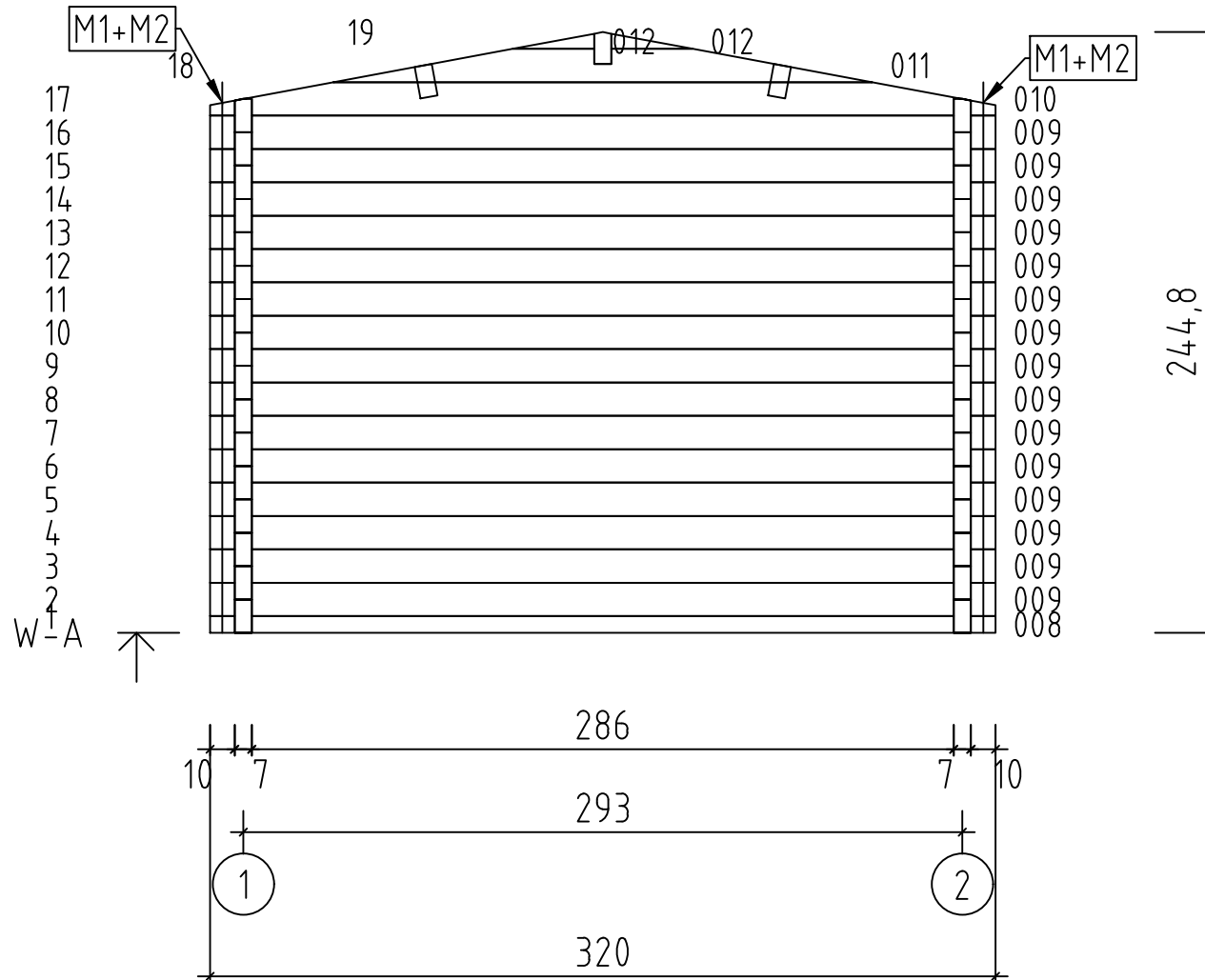







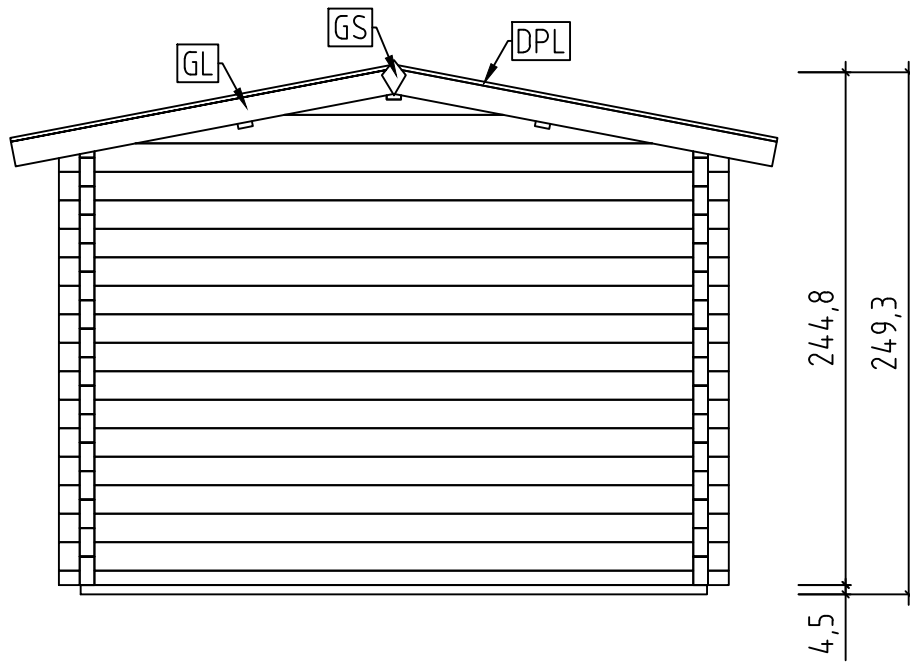

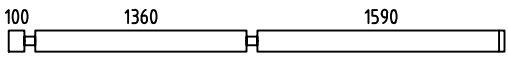

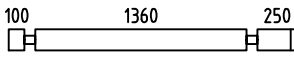

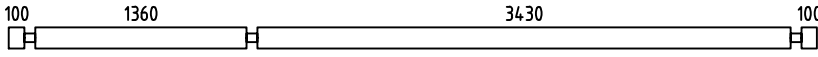
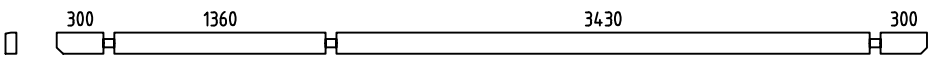
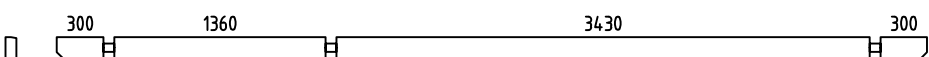
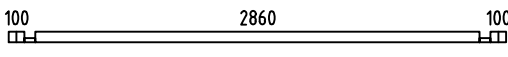
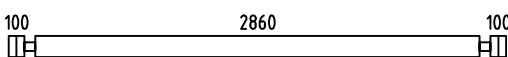
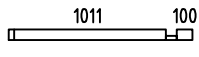
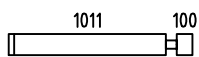
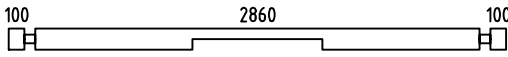
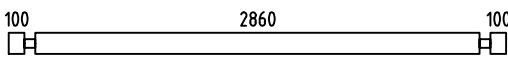
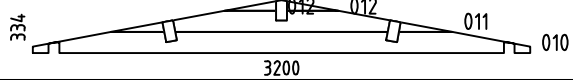
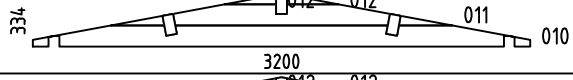
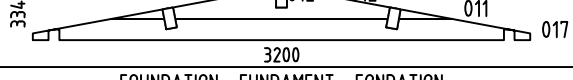

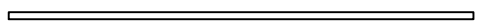

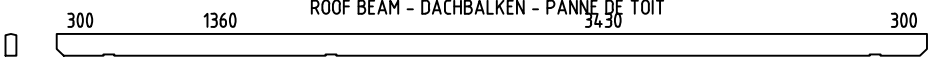

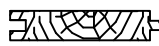





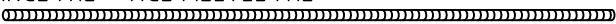
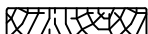



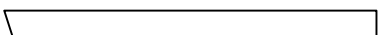
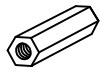



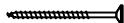
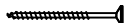
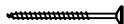
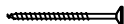
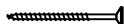

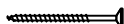



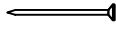
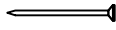

Pos	Avimore, Art.No.7013202 Piec list - Stückliste - Liste des pieces	Q.	P (mm)	L (mm)
001		4	70x136	3190
002		14	70x136	420
003		10	70x136	1850
004		10	70x136	309
005		16	70x136	5200
006		1	70x136	5600
007		1	70x136	5600
008		2	70x68	3200
009		30	70x136	3200
013		2	70x68	1182
014		26	70x136	1182
015		1	70x136	3200
016		1	70x136	3200
WA-1		1		
WB-1		1		
WC-1		1		
IAR3	FOUNDATION - FUNDAMENT - FONDATION 	8	70x45	4850
IAR1	FOUNDATION - FUNDAMENT - FONDATION 	2	70x45	2990
IAR2	FOUNDATION - FUNDAMENT - FONDATION 	5	70x45	486
PR1	ROOF BEAM - DACHBALKEN - PANNE DE TOIT 	1	70x140	5600
A-PR1	ROOF BEAM - DACHBALKEN - PANNE DE TOIT 	2	70x140	5600
FB	FLOOR BOARDS - FUSSBODENBRETTER - LAME DE PLANCHER 	55	90x18	2856
RB	ROOF BOARDS - DACHBRETTER - VOLIGES 	126	90x18	1800
FL	FLOOR FILLET-FUSSBODENLEISTE - CORNIERE DE FINITION DU PLANCHER 		15x40	21
DPL	ROOFING FELT FILLET - DACHPAPPENLEISTE - BAGUETTE DE FIXATION DU FEUTRE BITUMEUX 	4	18x58	1850

Pos	Avimore, Art.No.7013202 Piece list - Stückliste - Liste des pieces	Q.	P (mm)	L (mm)
M1	TREADED ROD M12 - GEWINDESTANGE M12 - TIGE FILETÉE M12 	4		190
M2	TREADED ROD M12 - GEWINDESTANGE M12 - TIGE FILETÉE M12 	4		2000
TB	EAVES BOARD - TRAUFBRETT - BANDEAU DE TOIT 	4	18x90	2800
DRV	ROOF EDGE REINFORCEMENT - DACHRANDVERSTÄRKUNG - CORNIERE DE RENFORT DE BORD DE TOIT 	4	28x34	2800
TBE6-1	FIXING FILLET FOR WINDOW - FIXIRUNGSLEISTE FÜR FENSTER - PROFIL DE FIXATION DES FENETRES 	2	28x34	1320
TBE6-2	FIXING FILLET FOR DOOR - FIXIRUNGSLEISTE FÜR TÜR - PROFIL DE FIXATION DES PORTES 	2	28x34	1768
TBE6-3	FIXING FILLET FOR DOOR - FIXIRUNGSLEISTE FÜR TÜR - PROFIL DE FIXATION DES PORTES 	2	28x34	1865
GL	GABLE MOULDING - GIEBELLEISTE - PLANCHE DE RIVE 	4	18x120	1850
KL4	LENGTHENING BOLT FOR TREADED ROD - VERLÄNGERUNGSMUTTER FÜR GEWINDESTANGE - MANCHON DE RACCORDEMENT DE TIGE FILETÉE 	4		
KL1	DRIVE NUT TREADED ROD - EINSHLAGMUTTER FÜR GEWINDESTANGE - ÉCROU A FRAPPER POUR TIGE FILITÉE 	4		
KL2	NUT FOR TREADED ROD - MUTTER FÜR GEWINDESTANGE - ÉCROU POUR TIGE FILETÉE 	4		
KL3	PLAIN WASHER TREADED ROD - UNTERLEGSSCHEIBE FÜR GEWINDESTANGE - RONDELLE PLATE POUR TIGE FILETÉE 	4		
HS12	SCREW FOR GABLE SEGMENT - SCHRAUBEN FÜR DECKBLATT - VIS POUR FIXATION LOSANGE DE FINITION 	4	3.5x35	
HS84	SCREW FOR FIXING FILLET - SCHRAUBEN FÜR FIXIRUNGSLEISTE - VIS POUR PROFIL DE FIXATION 	28	3.5x50	
HS16	SCREW FOR GABLE MOULDING - SCHRAUBEN FÜR GIEBELLEISTE - VIS DE FIXATION POUR PLANCHE DE RIVE 	24	3.5x50	
HS32	SCREW FOR EAVES BOARDS - SCHRAUBEN FÜR TRAUFBRETT - VIS DE FIXATION POUR BANDEAU DE TOIT 	24	4x40	
HS26	SCREW FOR ROOF EDGE REINFORCEMENT - SCHRAUBEN FÜR DACHRANDVERSTÄRKUNG - VIS POUR RENFORT DE BORD DE TOIT 	24	4x40	
HS40	SCREW FOR 1. WALL BEAM - SCHRAUBE FÜR 1. BOHLENREIHE - VIS DE FIXATION DES FONDATIONS 	10	5x120	
HS39	SCREW FOR FUNDAMENT - SCHRAUBEN ZUR BEFESTIGUNG FUNDAMENT - VIS POUR FONDATION 	56	5x120	
HS42	SCREW FOR GABLE - SCHRAUBEN FÜR GIEBEL - VIS POUR FIXATION DES PIGNONS 	6	5x120	
HS43	SCREW FOR ROOF BEAMS - SCHRAUBEN FÜR DACHBALKEN - VIS POUR PANNE DE TOIT 	9	5x120	
MS	SCREW FOR DOORSTEP - SCHRAUBEN FÜR TÜRSCHWELLE - VIS DE FIXATION DU SEUIL DE PORTE 	5	4.5x65	
SH70	HAMMER BLOCK - SCHLAGHOLZ - CALLE DE FRAPPE 	1		
NFD	ZN NAIL FOR ROOFING FELT FILLET - ZN NÄGEL FÜR DACHPAPPENLEISTE - POINTE POUR BAGUETTE FIXATION FEUTRE BITUMEUX 	20	2x40	
NFF	ZN NAIL FOR FLOOR FILLETS - ZN NÄGEL FÜR FUSSBODENLEISTEN - POINTE POUR PANNEAUX DE PLANCHER 	20	1.4x40	

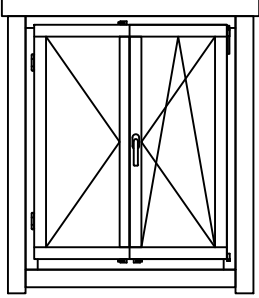
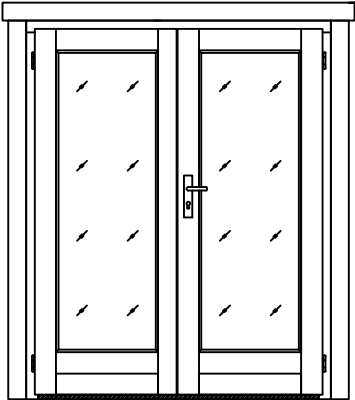
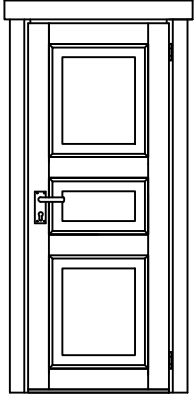
Pos	Aviomore, Art.No.7013202 Piece list - Stückliste - Liste des pieces	Q.	P (mm)	L (mm)
NF2	ZN NAIL FOR ROOF - ZN NÄGEL FÜR DACHBRETTER - POINTE POUR TOIT 	400	2.1x50	
NH1	ZN NAIL FOR FLOOR - ZN NÄGEL FÜR FUSSBODENBRETTER - CLOUS POUR PLANCHER 	250	2.1x50	
ORZ	MONTAGE SET FOR DOORS AND WINDOWS - MONTAGE-SET FÜR TÜREN UND FENSTER - JEU DE MONTAGE PORTES ET FENETRES	1		
GS	GABLE SEGMENT-DECKBLATT - LOSANGE DE FINITION 	2		
	WINDOW-FENSTER-FENETRE <span style="float: right;">1021x1320 2+ TA.0P.d</span> 	1		
	DOOR-TÜR-PORTE <span style="float: right;">1580x1865 2+ TU.10P.c</span> 	1		
	DOOR-TÜR-PORTE <span style="float: right;">827x1865 U.3TP.c</span> 	1		

