

Lyndhurst 70
Art. Nr.7011902

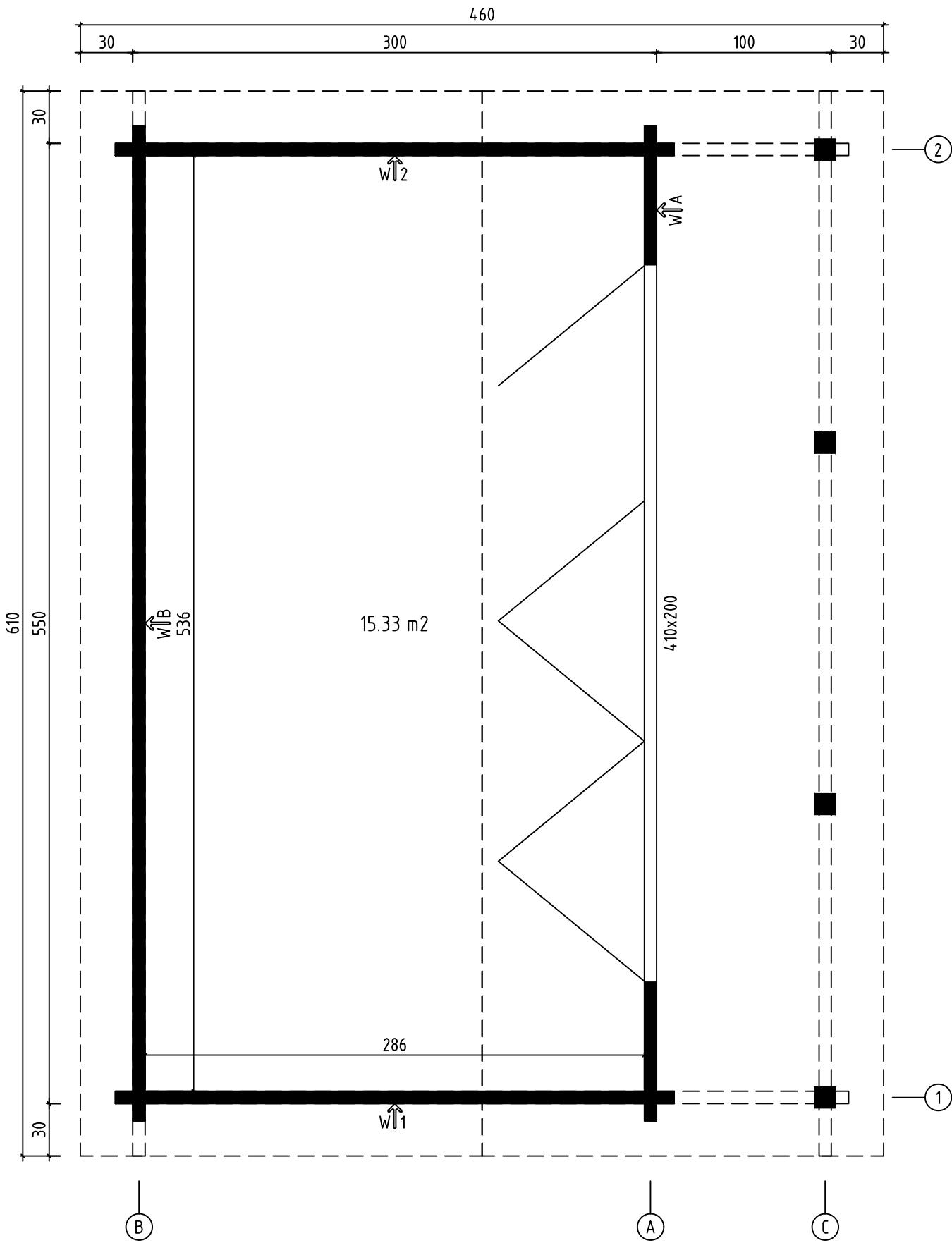

Lyndhurst 70, Art.Nr.7011902
GROUNDPLAN - GRUNDPLAN - PLAN DE MASSE



Lyndhurst 70, Art.Nr.7011902
FOUNDATION - FUNDAMENT - FONDATION

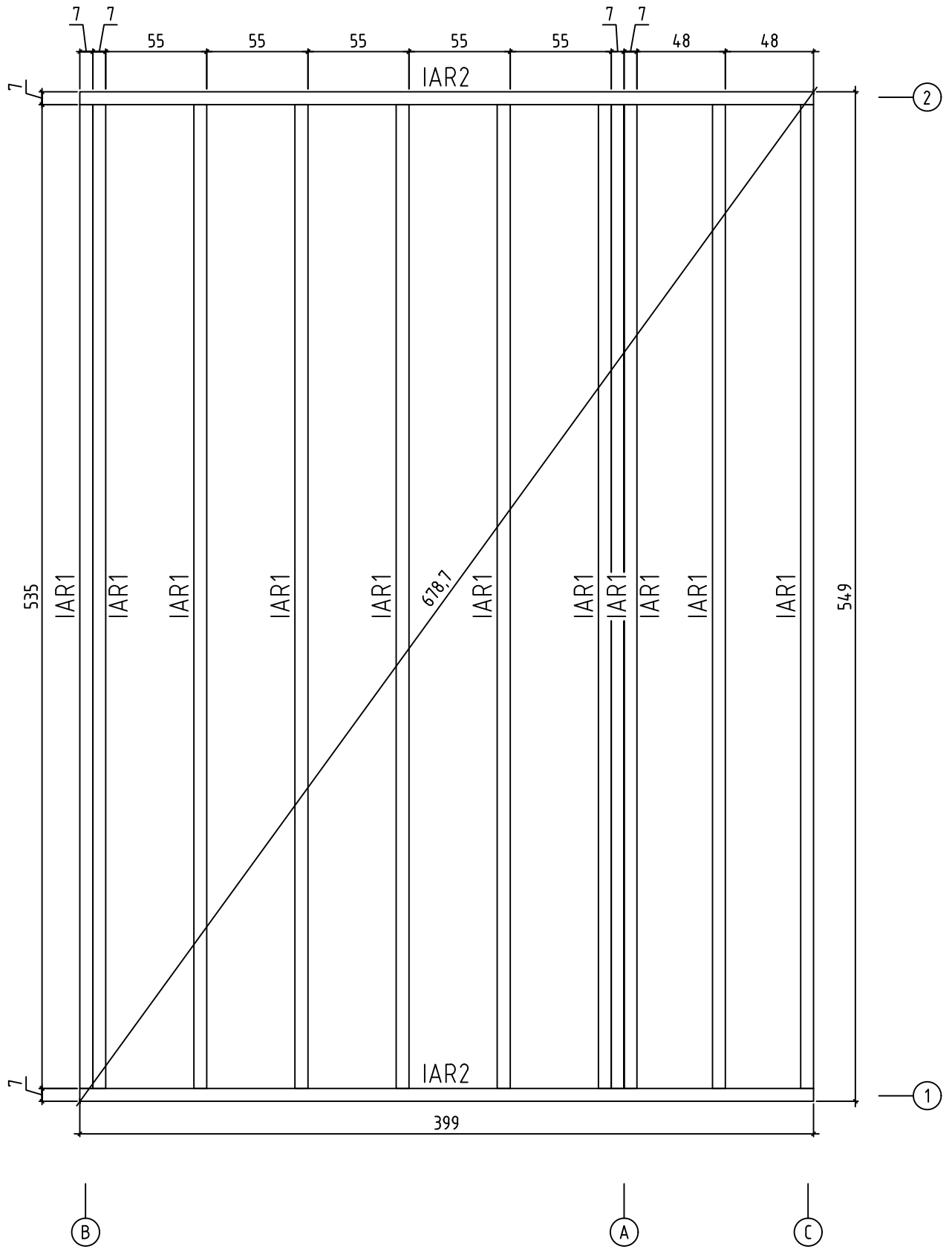

Lyndhurst 70, Art.Nr.7011902
FLOOR BOARDS - FUSSBODENBRETTER - PLAN POSE PLANCHER
TERRACE BOARDS - TERRASSENBRETTER - PLANCHER DE TERRASSE

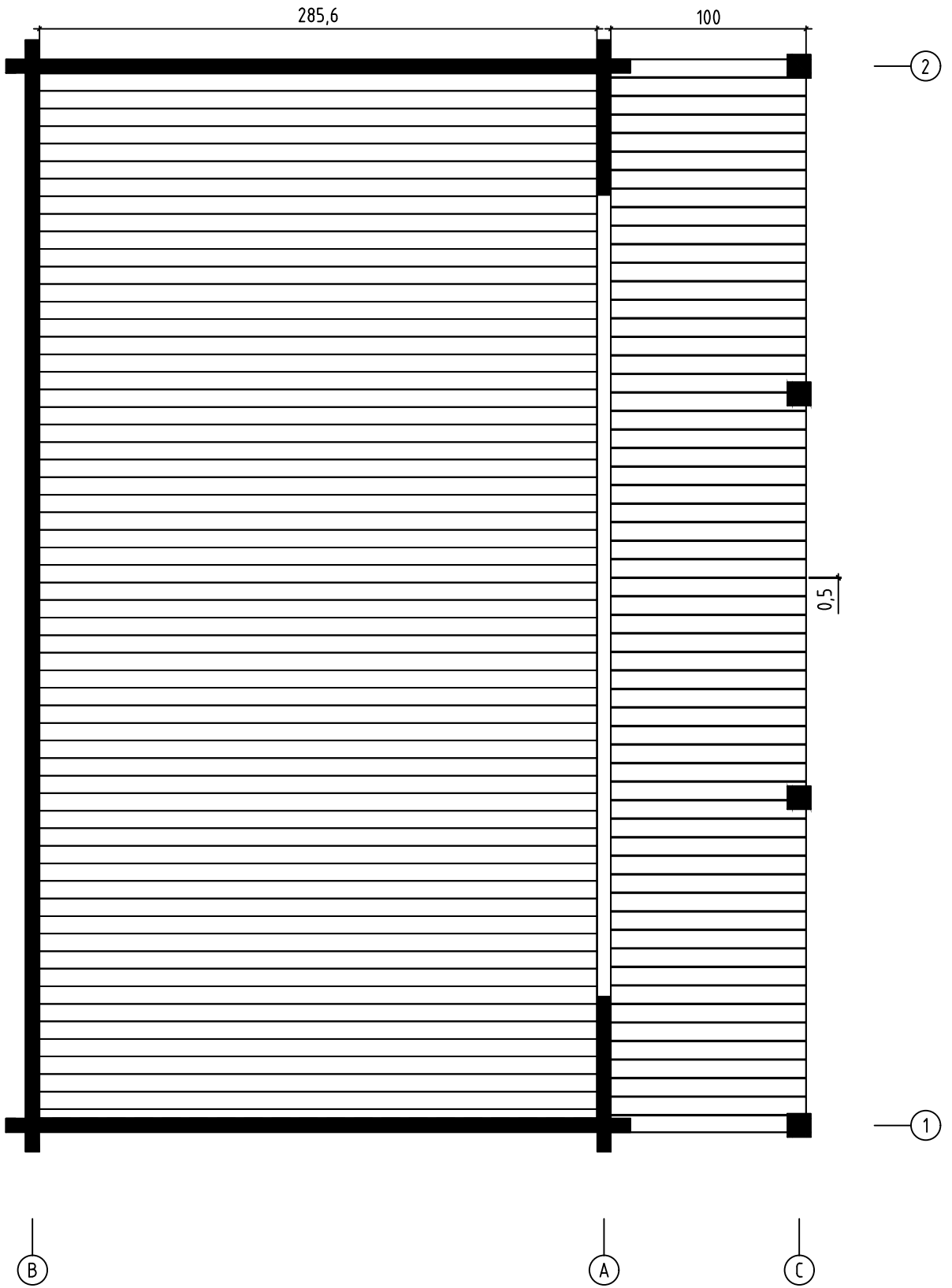

Lyndhurst 70, Art.Nr.7011902

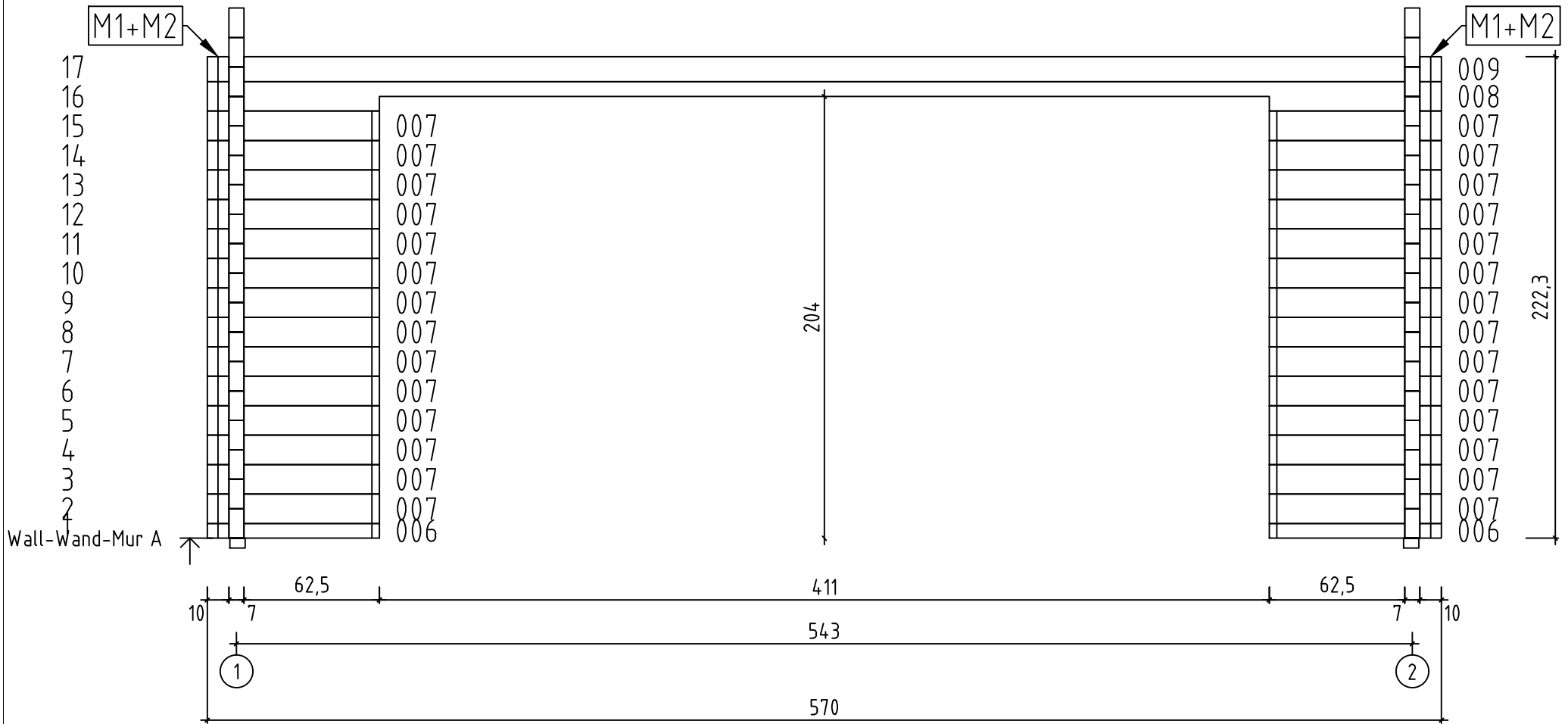

Lyndhurst 70, Art.Nr.7011902

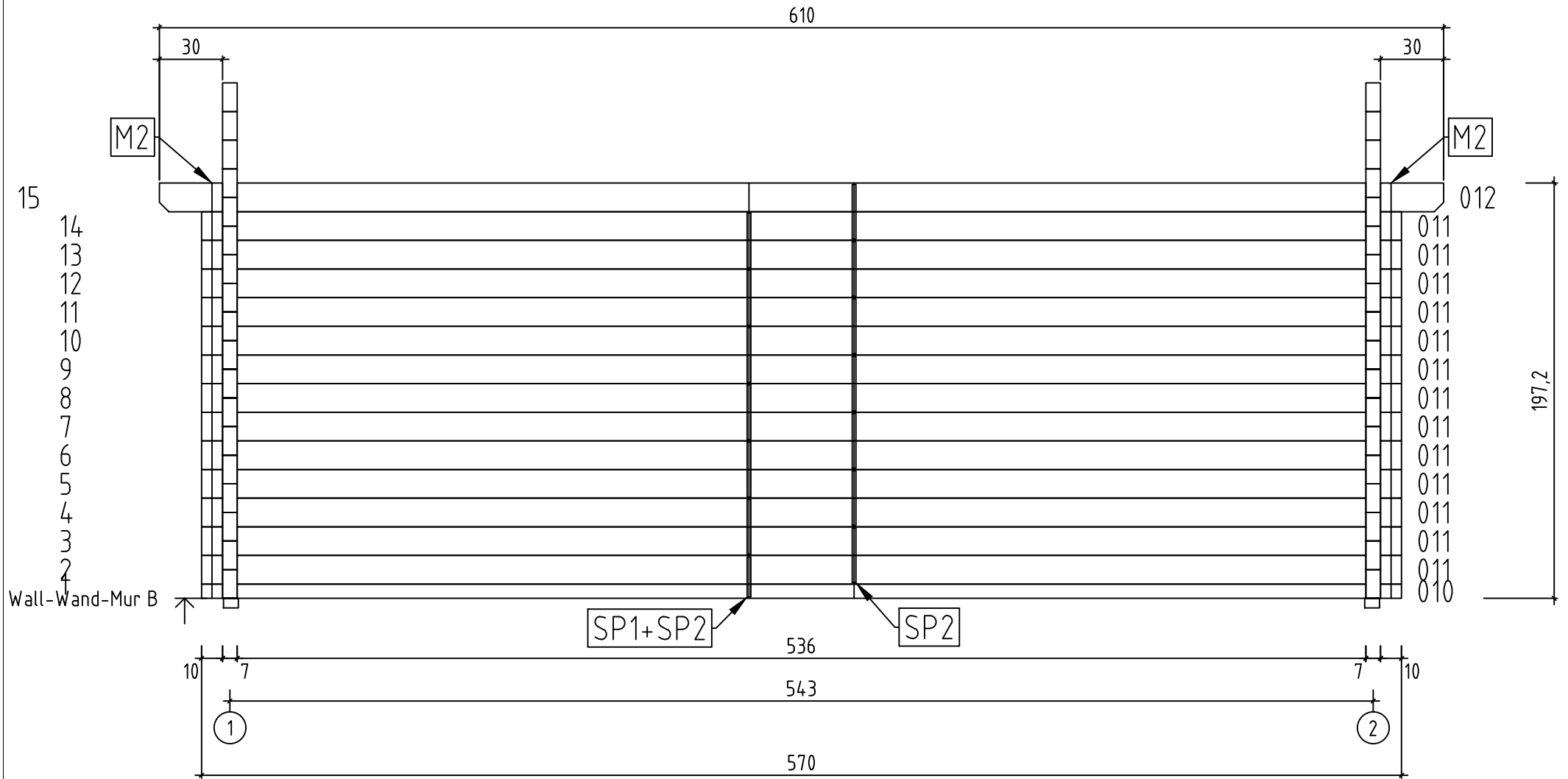

Lyndhurst 70, Art.Nr.7011902

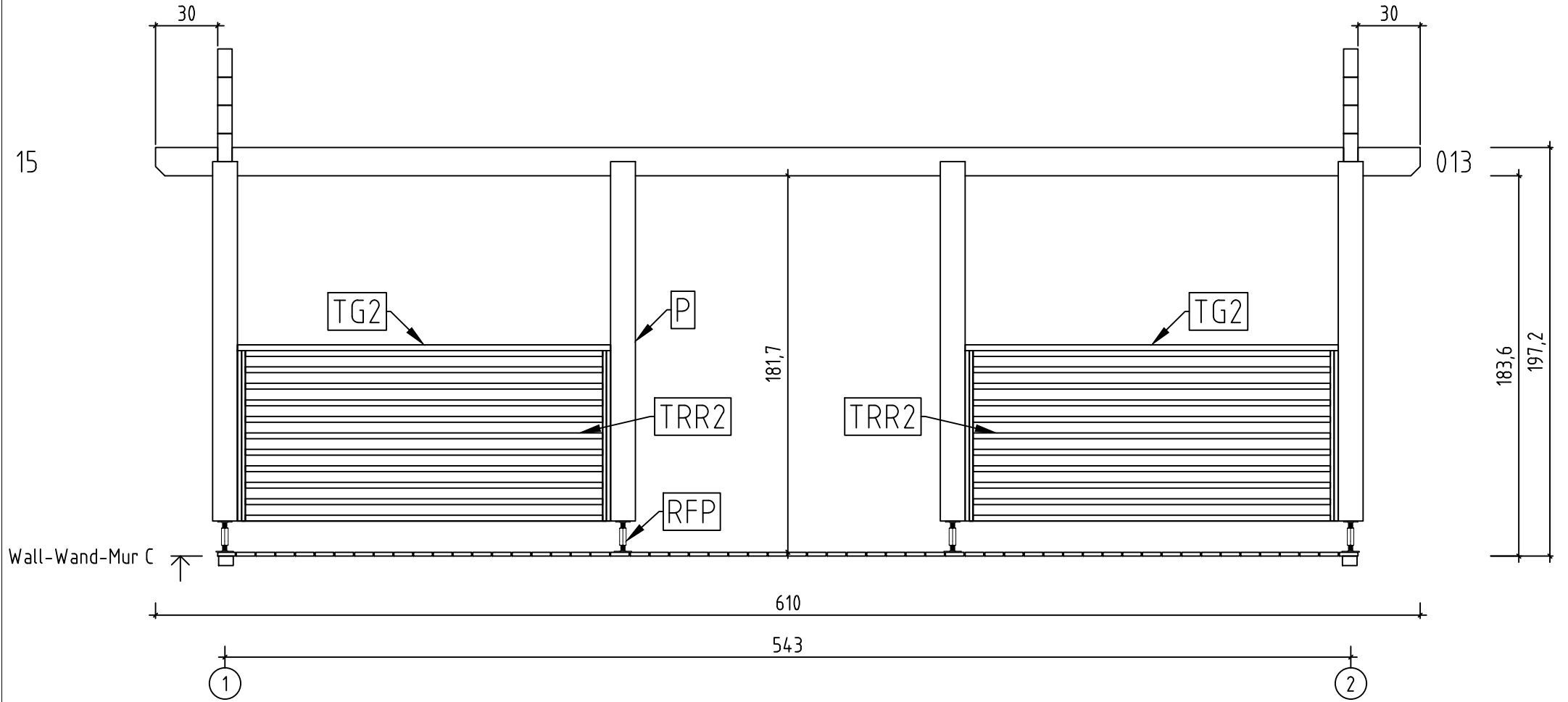



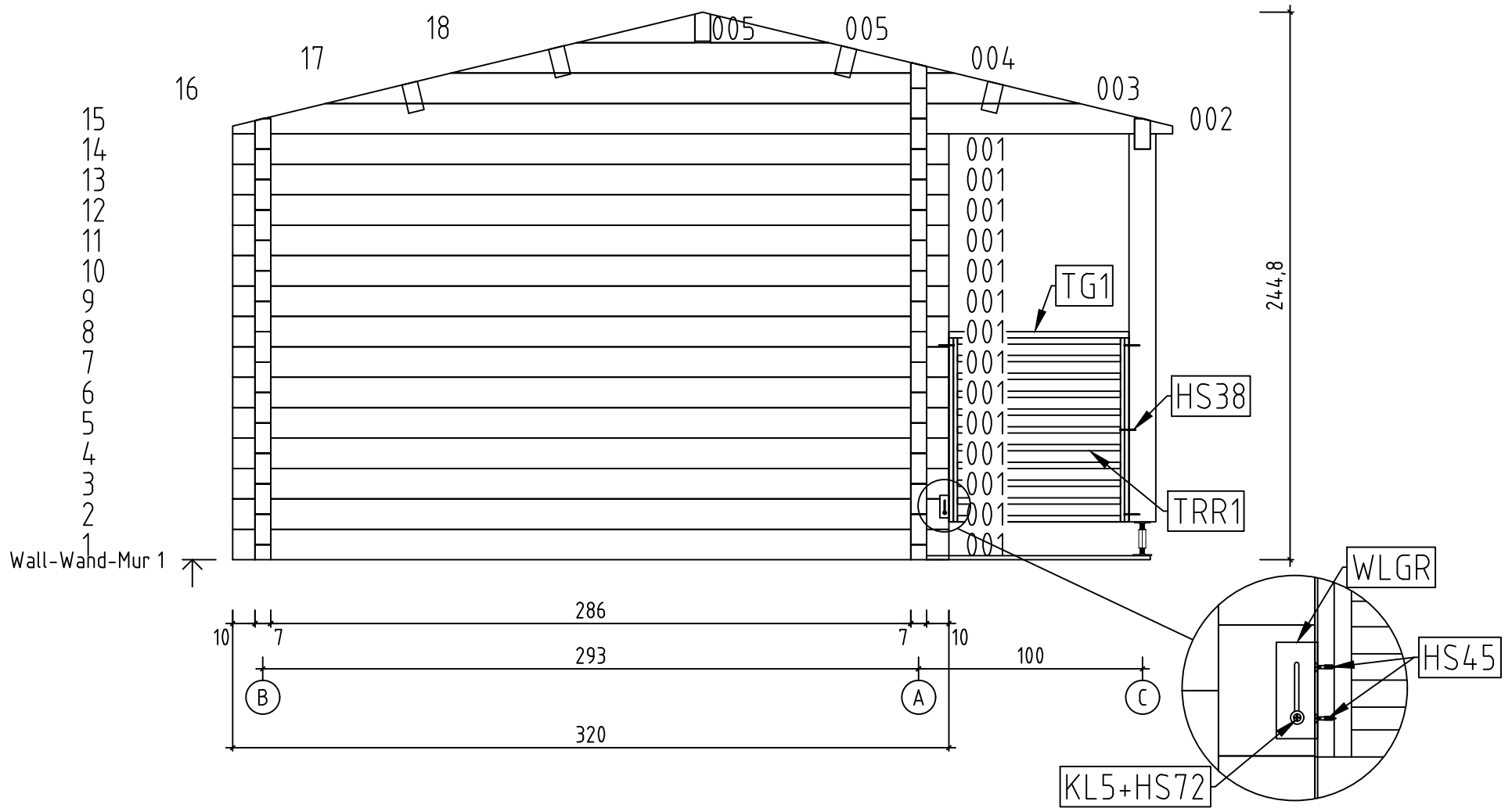



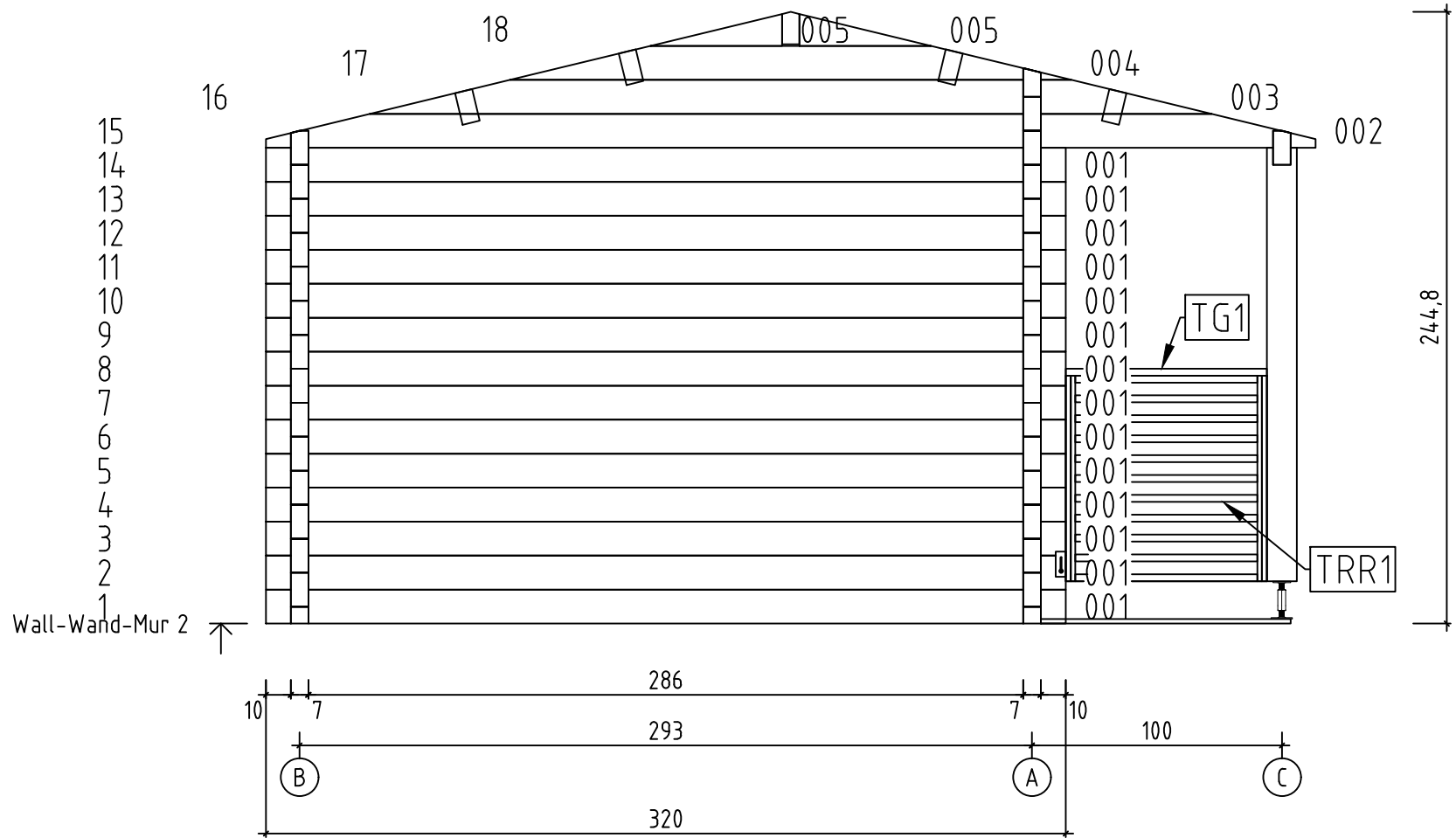

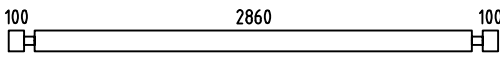
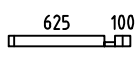
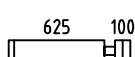
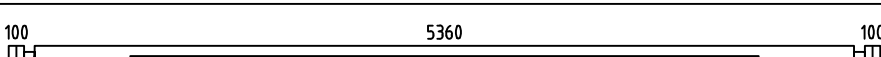
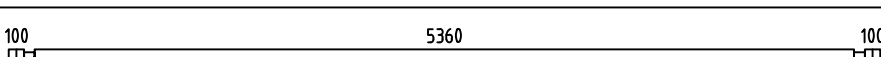
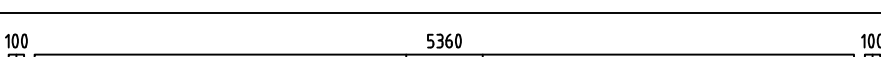
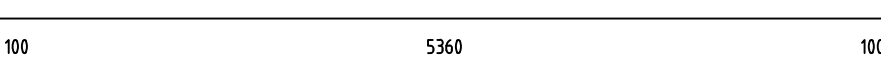
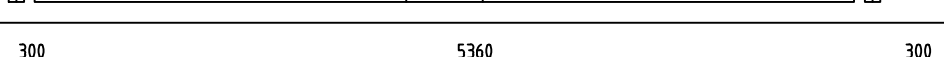
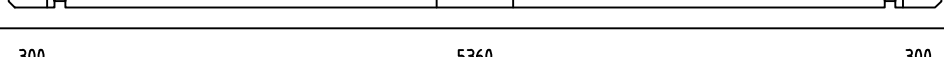
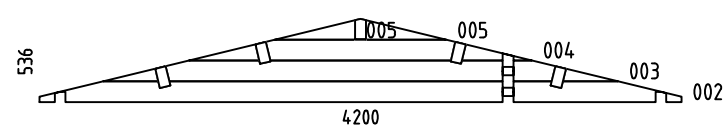
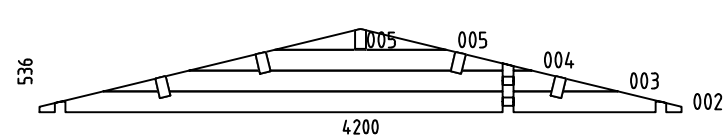
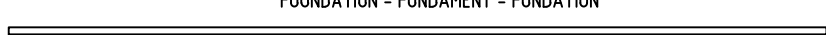



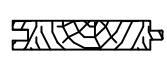



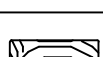

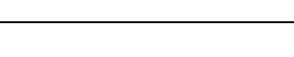
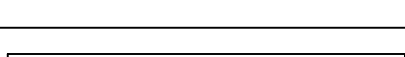

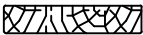
Lyndhurst 70, Art.Nr.7011902



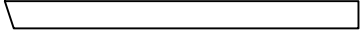
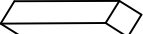
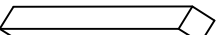



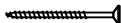
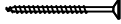
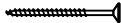
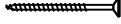
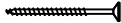
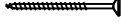
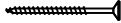
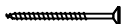
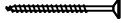
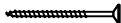
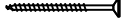
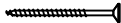

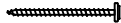
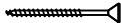

Lyndhurst 70, Art.Nr.7011902

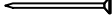
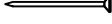

Pos	Lyndhurst 70, Art.Nr.7011902 Piece list - Stückliste - Liste des pieces	Q.	P (mm)	L (mm)
001		28	70x136	3200
006		2	70x68	795
007		28	70x136	795
008		1	70x136	5700
009		1	70x115	5700
010		1	70x68	5700
011		13	70x136	5700
012		1	70x136	6100
013		1	70x136	6100
W1-1		1		
W2-1		1		
IAR1	FOUNDATION - FUNDAMENT - FONDATION 	11	70x45	5350
IAR2	FOUNDATION - FUNDAMENT - FONDATION 	2	70x45	3990
PR1	ROOF BEAM - DACHBALKEN - PANNE DE TOIT 	1	70x140	6100
A-PR1	ROOF BEAM - DACHBALKEN - PANNE DE TOIT 	4	70x140	6100
FB-1	FLOOR BOARDS - FUSSBODENBRETTER - LAME DE PLANCHER 	60	90x18	2856
RB-1	ROOF BOARDS - DACHBRETTER - VOLIGES 	136	90x18	2367
SV-1	TERRACE BOARDS - TERRASSENBRETTER - PLANCHER DE TERRASSE 	58	90x19	1000
FL-1	FLOOR FILLET-FUSSBODENLEISTE - CORNIERE DE FINITION DU PLANCHER 		18x18	17 m.
DPL-1	ROOFING FELT FILLET - DACHPAPPENLEISTE - BAGUETTE DE FIXATION DU FEUTRE BITUMEUX 	4	18x58	2417
M1	TREADED ROD M12 - GEWINDESTANGE M12 - TIGE FILETÉE M12 	2		250
M2	TREADED ROD M12 - GEWINDESTANGE M12 - TIGE FILETÉE M12 	4		2000
P	POST - PFOSTEN - POTEAU 	4	120x120	1735

Pos	Lyndhurst 70, Art.Nr.7011902 Piece list - Stückliste - Liste des pieces	Q.	P (mm)	L (mm)
TB-1	EAVES BOARD - TRAUFBRETT - BANDEAU DE TOIT 	4	18x90	3050
DRV-1	ROOF EDGE REINFORCEMENT - DACHRANDVERSTÄRKUNG - CORNIERE DE RENFORT DE BORD DE TOIT 	4	28x34	3050
TBE6-1	FIXING FILLET FOR DOOR - FIXIRUNGSLEISTE FÜR TÜR - PROFIL DE FIXATION DES PORTES 	2	28x34	1935
TG1	GUARD-RAIL FOR TERRACE - TERRASSEN GELÄNDER - MAIN COURANTE DE TERRASSE 	2	28x120	805
TG2	GUARD-RAIL FOR TERRACE - TERRASSEN GELÄNDER - MAIN COURANTE DE TERRASSE 	2	28x120	1800
GL-1	GABLE MOULDING - GIEBELLEISTE - PLANCHE DE RIVE 	4	18x120	2417
SP1	HIDDEN FIXING - HOLZDÜBEL - TOURILLON BOIS 	1		190
SP2	HIDDEN FIXING - HOLZDÜBEL - TOURILLON BOIS 	13		260
KL4	LENGTHENING BOLT FOR TREADED ROD - VERLÄNGERUNGSMUTTER FÜR GEWINDESTANGE - MANCHON DE RACCORDEMENT DE TIGE FILETÉE 	2		
KL1	DRIVE NUT TREADED ROD - EINSHLAGMUTTER FÜR GEWINDESTANGE - ÉCROU A FRAPPER POUR TIGE FILETÉE 	4		
KL2	NUT FOR TREADED ROD - MUTTER FÜR GEWINDESTANGE - ÉCROU POUR TIGE FILETÉE 	4		
KL3	PLAIN WASHER TREADED ROD - UNTERLEGSCHIEBE FÜR GEWINDESTANGE - RONDELLE PLATE POUR TIGE FILETÉE 	4		
HS12	SCREW FOR GABLE SEGMENT - SCHRAUBEN FÜR DECKBLATT - VIS POUR FIXATION LOSANGE DE FINITION 	4	3.5x35	
HS84	SCREW FOR FIXING FILLET - SCHRAUBEN FÜR FIXIRUNGSLEISTE - VIS POUR PROFIL DE FIXATION 	10	3.5x50	
HS16	SCREW FOR GABLE MOULDING - SCHRAUBEN FÜR GIEBELLEISTE - VIS DE FIXATION POUR PLANCHE DE RIVE 	32	3.5x50	
HS38	SCREW FOR FIXING TERRACE RAILING - SCHRAUBE FÜR TERRASSE VIS DE FIXATION DE GARDE-CORPS DE TERRASSE 	18	4.5x80	
HS45	SCREW FOR SLIDING WALL TIE - SCHRAUBEN FÜR WAND SCHIEBEREGLER - VIS POUR FIXATION ÉQUERRE MÉTALLIQUE AU PARAVENT 	8	4x20	
HS32	SCREW FOR EAVES BOARDS - SCHRAUBEN FÜR TRAUFBRETT - VIS DE FIXATION POUR BANDEAU DE TOIT 	28	4x40	
HS26	SCREW FOR ROOF EDGE REINFORCEMENT - SCHRAUBEN FÜR DACHRANDVERSTÄRKUNG - VIS POUR RENFORT DE BORD DE TOIT 	28	4x40	
HS34	SCREW FOR POST - SCHRAUBEN FÜR PFOSTEN - VIS DE FIXATION DES POTEAUX 	8	4x60	
HS30	SCREW FOR TERRACE REAR BOARDS - SCHRAUBEN FÜR TERRASSEN RAND - VIS DE FIXATION POUR MAIN COURANTE DE TERRASSE 	18	4x60	
HS40	SCREW FOR 1. WALL BEAM - SCHRAUBE FÜR 1. BOHLENREIHE - VIS DE FIXATION DES FONDATIONS 	8	5x120	
HS39	SCREW FOR FUNDAMENT - SCHRAUBEN ZUR BEFESTIGUNG FUNDAMENT - VIS POUR FONDATION 	30	5x120	
HS42	SCREW FOR GABLE - SCHRAUBEN FÜR GIEBEL - VIS POUR FIXATION DES PIGNONS 	16	5x120	
HS49	SCREW FOR POST HEIGHT ADJUSTMENT - SCHRAUBEN FÜR REGULIERUNGSSCHRAUBE FÜR PFOSTEN - VIS DE FIXATION DE SUPPORT RÉGLABLE DE POTEAU 	32	6x50	

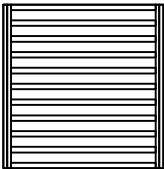
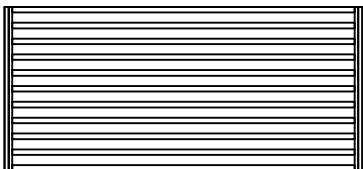
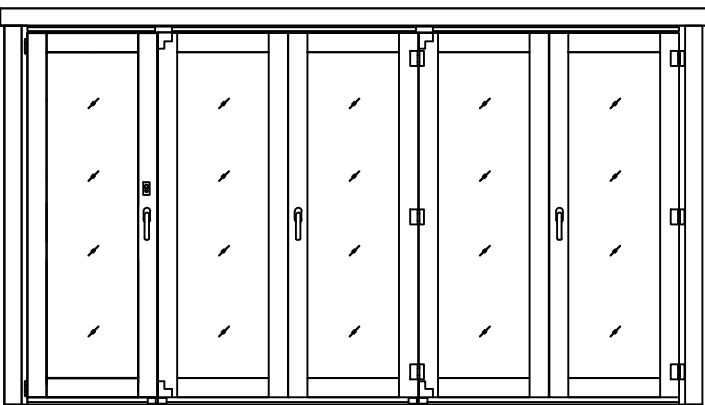
Pos	Lyndhurst 70, Art.Nr.7011902 Piece list - Stückliste - Liste des pieces	Q.	P (mm)	L (mm)
MS	SCREW FOR DOORSTEP - SCHRAUBEN FÜR TÜRSCHWELLE - VIS DE FIXATION DU SEUIL DE PORTE 	5	4.5x65	
NF3	SCREW FOR TERRACE BOARD - SCHRAUBEN FÜR TERRASSENBRETT - VIS POUR LAME DE SEUIL D'ENTREE DE TERRASSE 	348	4.2x55	
SH70	HAMMER BLOCK - SCHLAGHOLZ - CALLE DE FRAPPE 	2		
NFD	ZN NAIL FOR ROOFING FELT FILLET - ZN NÄGEL FÜR DACHPAPPENLEISTE - POINTE POUR BAGUETTE FIXATION FEUTRE BITUMEUX 	24	2x40	
NFF	ZN NAIL FOR FILLETS - ZN NÄGEL FÜR LEISTEN - POINTE POUR CORNIERE 	33	1.4x40	
NF2	ZN NAIL FOR ROOF - ZN NÄGEL FÜR DACHBRETT - POINTE POUR TOIT 	564	2.1x50	
NH1	ZN NAIL FOR FLOOR - ZN NÄGEL FÜR FUSSBODENBRETT - CLOUS POUR PLANCHER 	366	2.1x50	
ORZ	MONTAGE SET FOR DOORS AND WINDOWS - MONTAGE-SET FÜR TÜREN UND FENSTER - JEU DE MONTAGE PORTES ET FENETRES	1		
GS	GABLE SEGMENT-DECKBLATT - LOSANGE DE FINITION 	2		
WLGR	SLIDING WALL TIE - SCHIEBEREGLER FÜR WAND - EQUERRE MÉTALLIQUE DE FIXATION DU PARAVENT 	2		
RFP	POST HEIGHT ADJUSTMENT - REGULIERUNGSSCHRAUBE FÜR PFOSTEN - SUPPORT RÉGLABLE DE POTEAU 	4		
TRR1	TERRACE RAILING - TERRASSE - GARDE-CORPS DE TERRASSE 	2		805
TRR2	TERRACE RAILING - TERRASSE - GARDE-CORPS DE TERRASSE 	2		1800
	DOOR-TÜR-PORTE 4100x2000  4100x2000 3+ TU5V.20V Assembly video - Montage video - Video de montage http://www.orthez.ee/Folding_new.mp4	1		

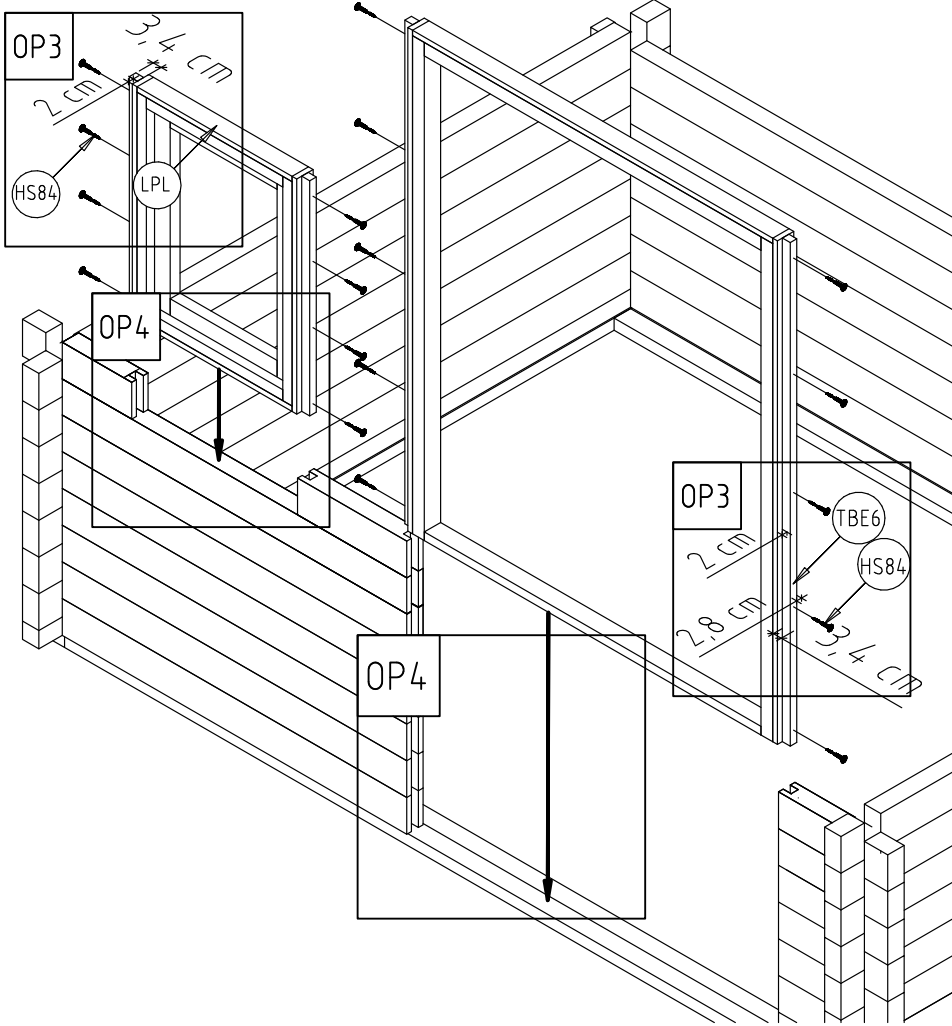
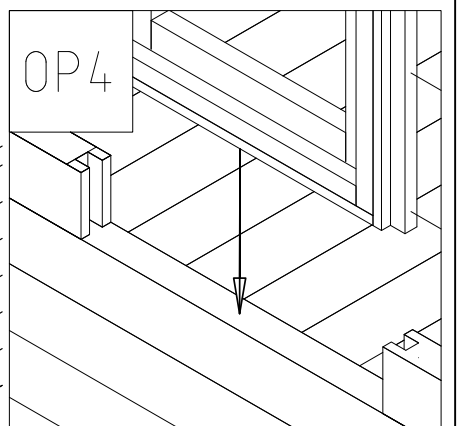
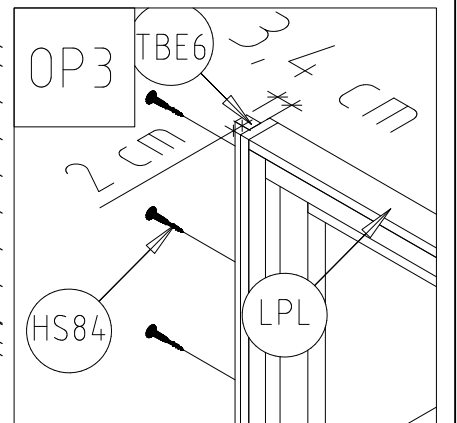
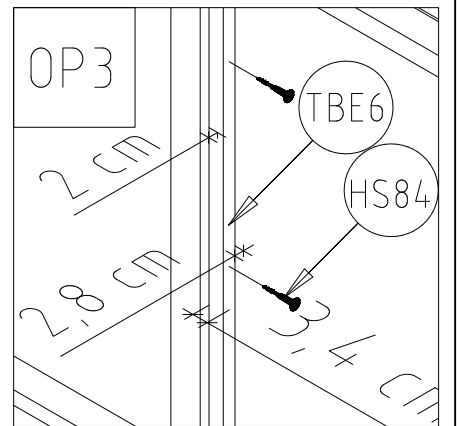
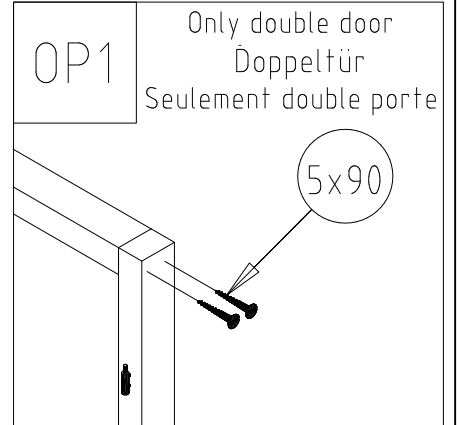
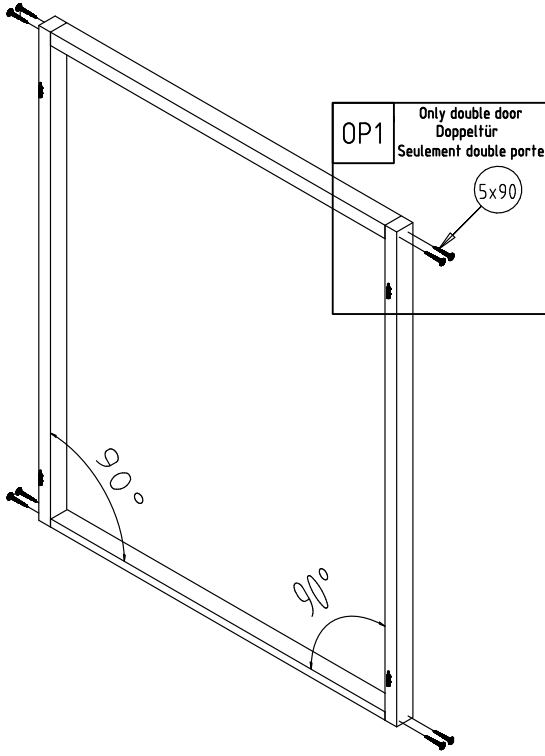

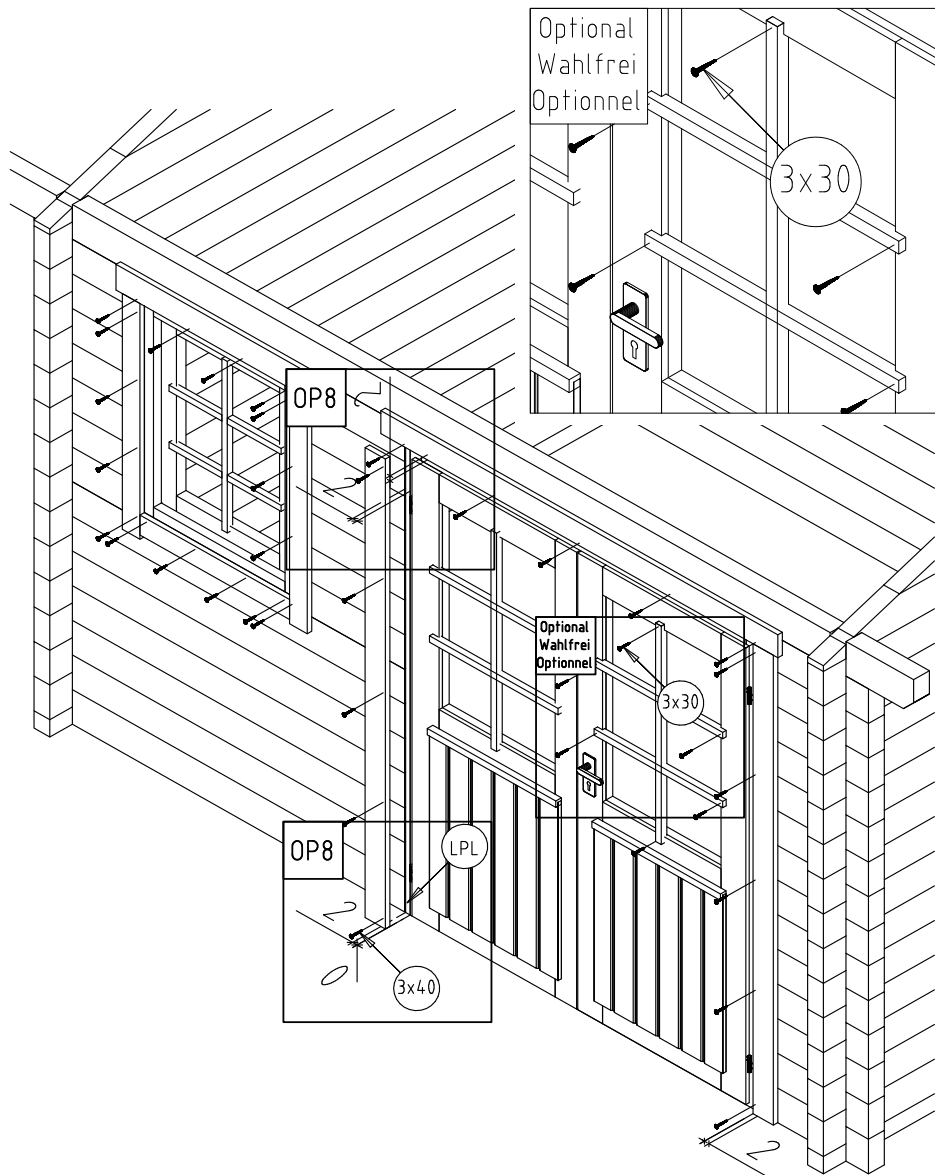
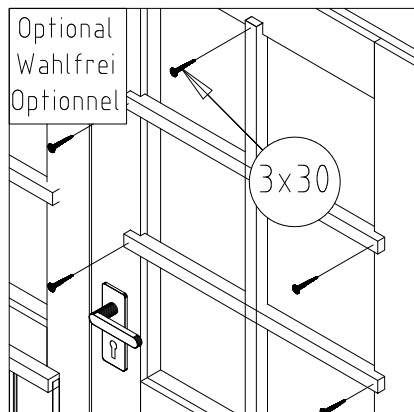
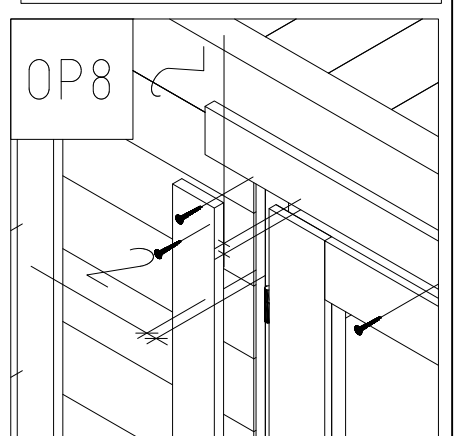
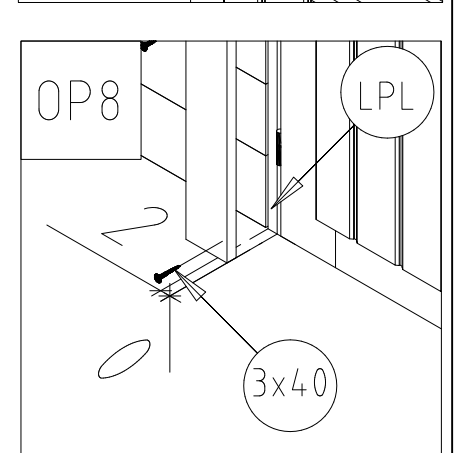
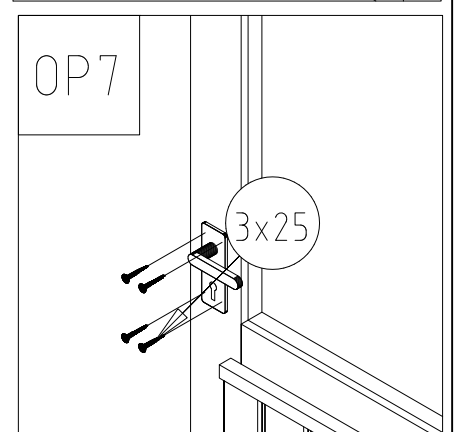
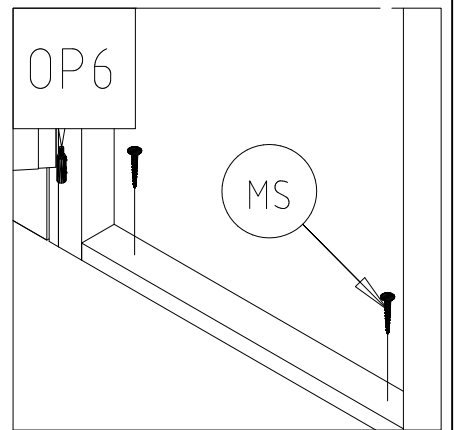
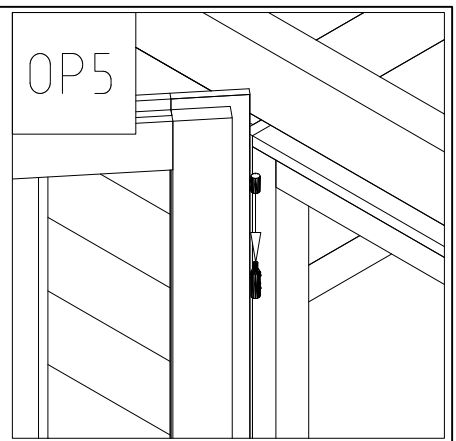
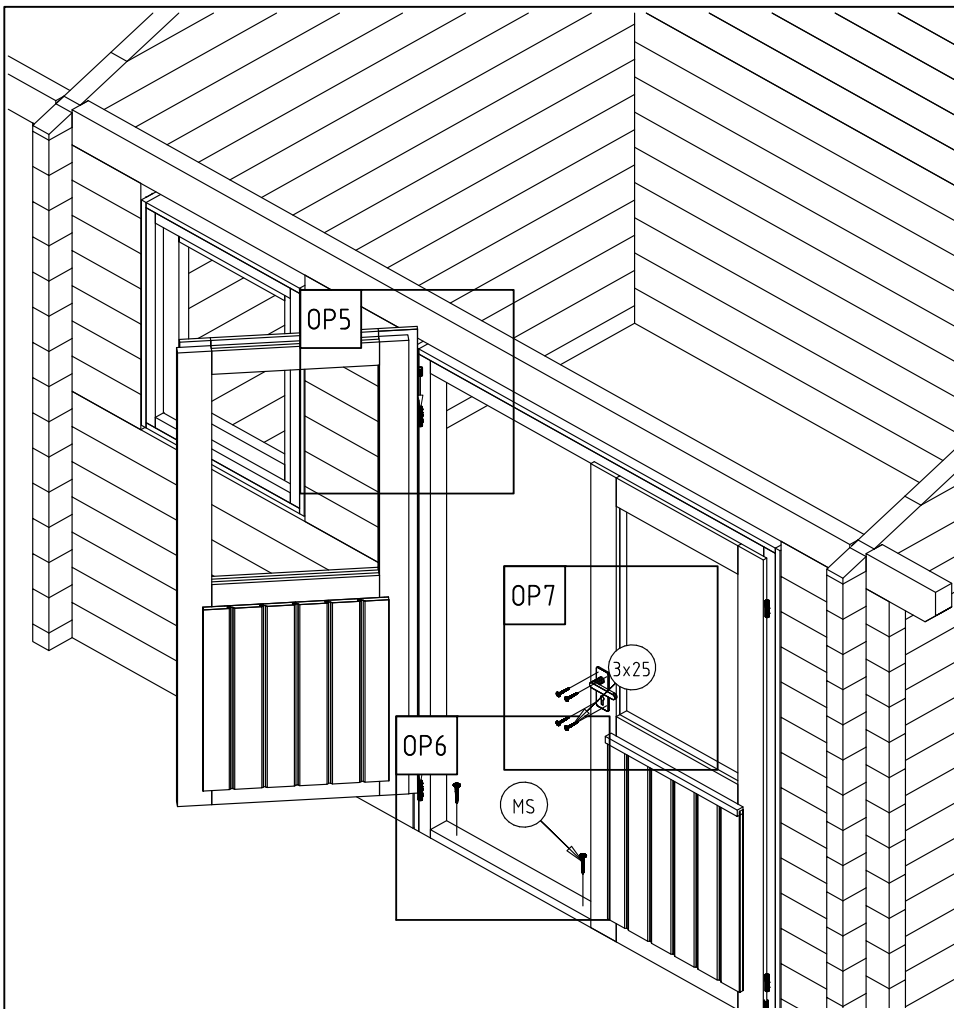

5 DOOR BIFOLD DOOR SET "541"

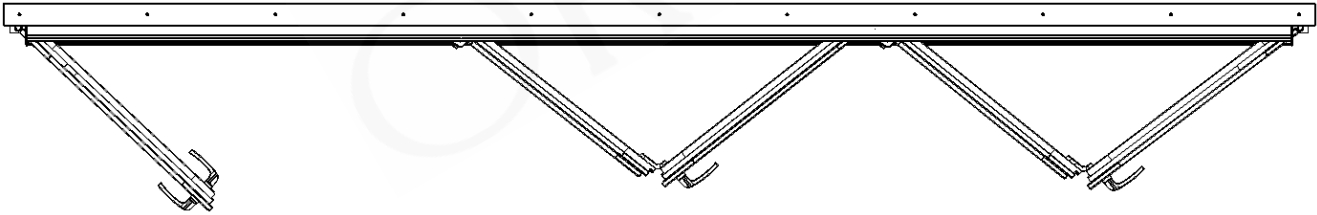
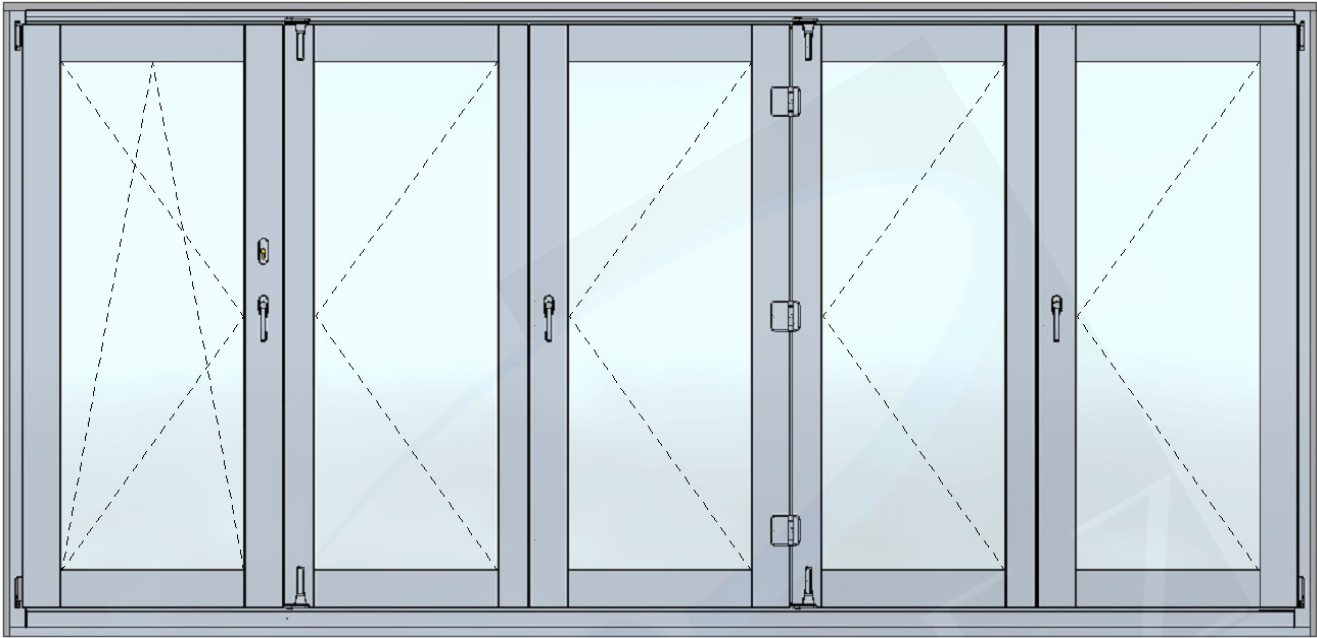

Hardware

A. 6 x 140 mm Screw x **10**

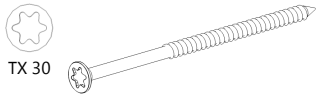

B. 3,5 x 40 mm Screw x **61**



C. Plastic push x **18**

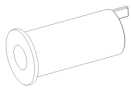

D. Upper guide roll x **2**

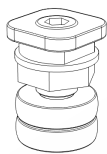

E. Lower guide roll x **2**

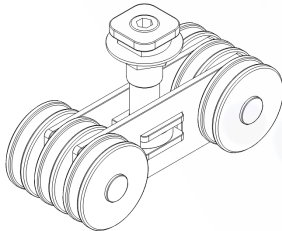

F. Lock set

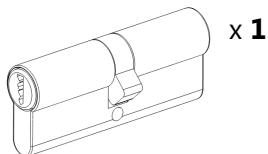

G. Open-end spanner SW17 x **1**



H. Plastic cover x **1**

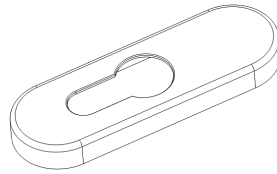

I. CB rosette inside x **1**

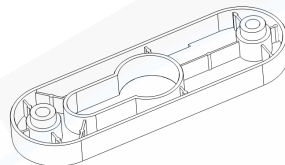

J. CB rosette outside x **1**

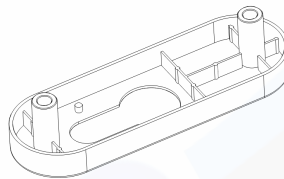

K. Cover cap x **9**

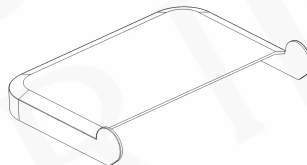

L. Cover cap x **9**

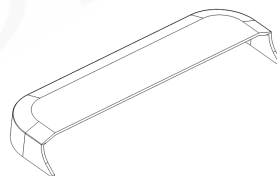

M. Cover cap for stay hinge x **2**

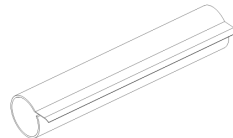

Pins (x 11) are pre-installed



N. Cover cap for stay bearing x **2**

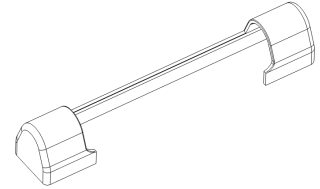

O. Cover cap x **1 RH** + x **1 LH**

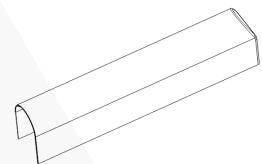

P. Cover cap for pivot rest x **2**

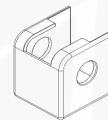

R. Turn handle x **2**

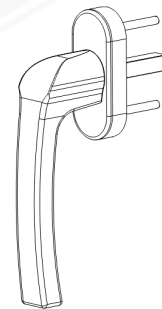

S. Turn handle set

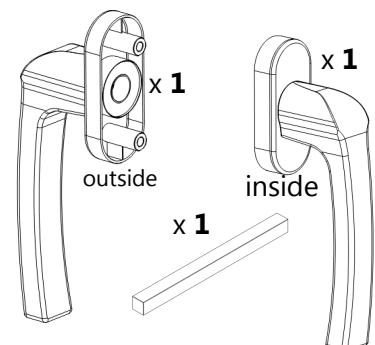
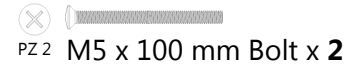

Parts list

LH
x 1

RH
x 1

x 4

x 2

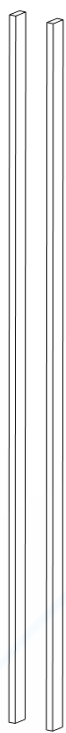
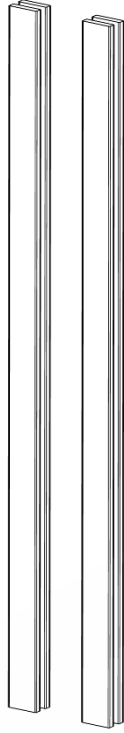
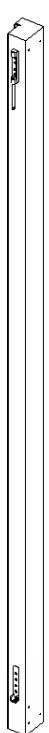

x 1

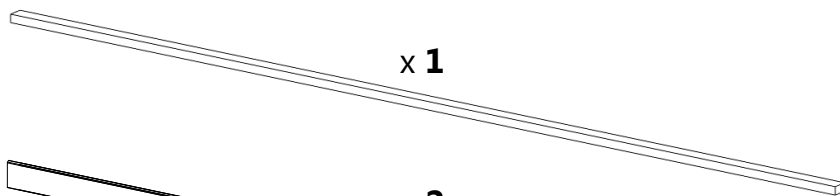

x 2

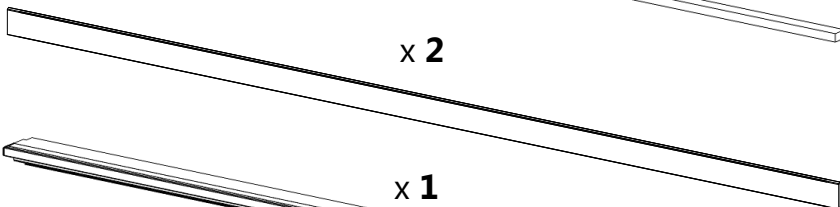

x 1

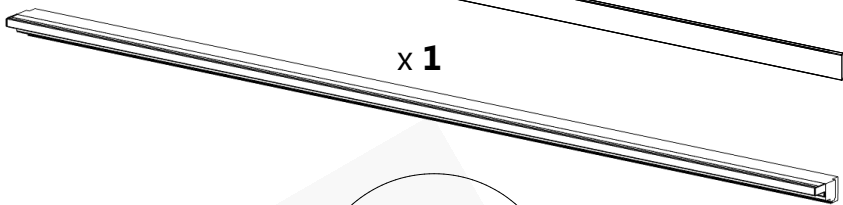

TOP

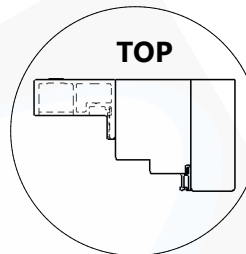

x 1

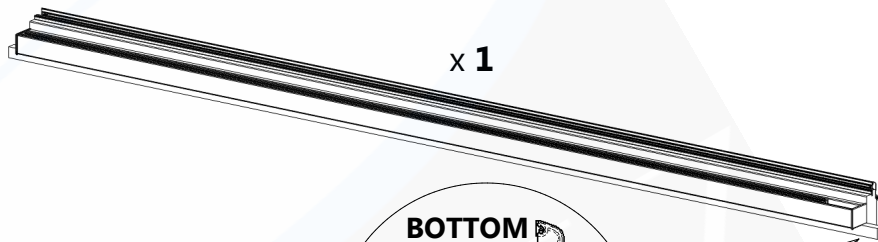

BOTTOM

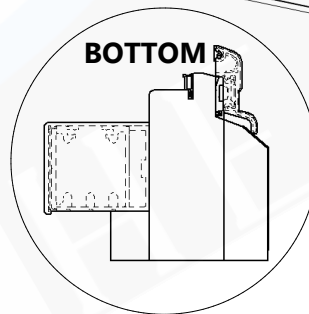

x 1

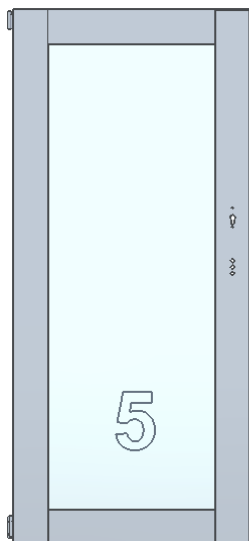

x 1

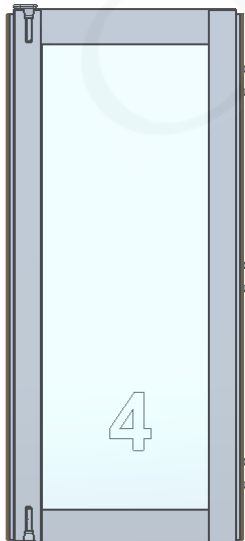

x 1

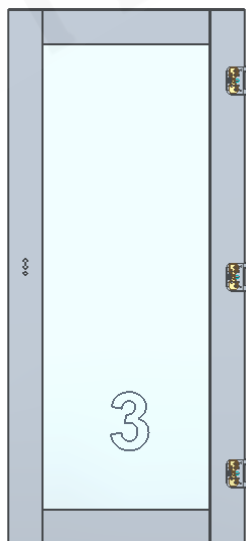

x 1

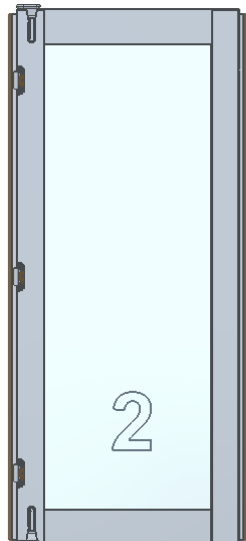

x 1

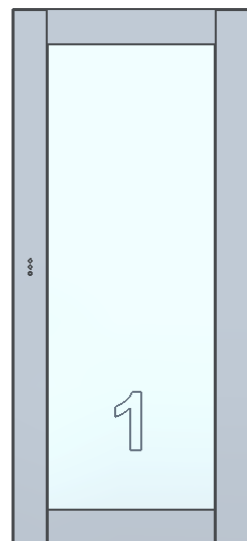

5

4

3

2

1

Door frame assembling



□ Lay the 4 pcs of frame parts on the floor on top of cardboard or a similar protective material to prevent damage to the parts.

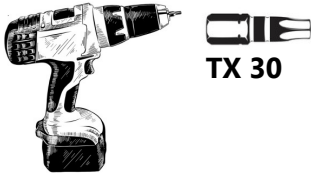

TX 30

Tools not supplied!

A. 6 x 140 mm Screw x 10

Step 1

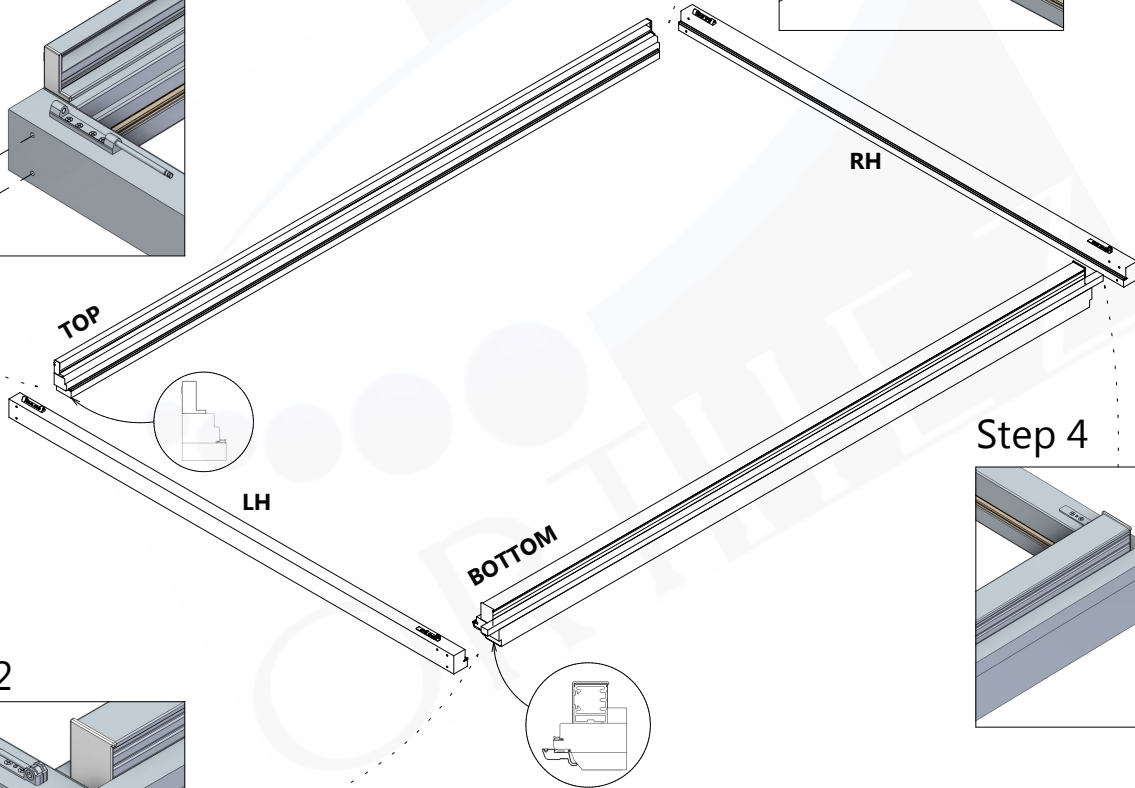
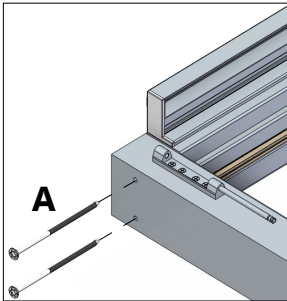

Step 3

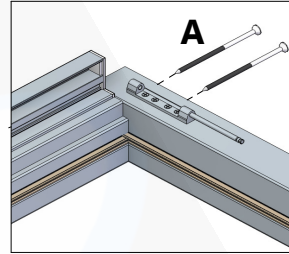

Step 4

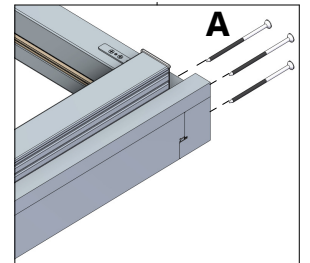

Step 2

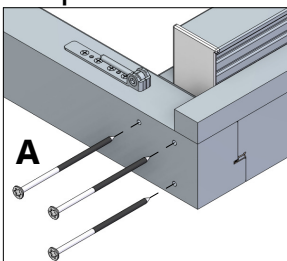

Filling bar assembling



TX 15

Tools not supplied!

B. 3,5 x 40 mm Screw x 21



Note!

Variations depending on wall thicknesses:

- filling bars **are** assembled by the factory
- filling bars **are not** assembled, follow instructions below

Step 1

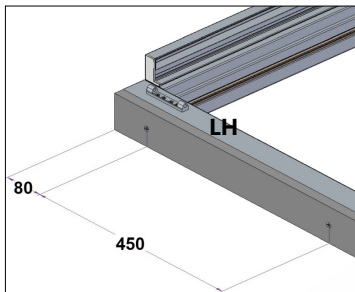

80

450

LH

Step 3

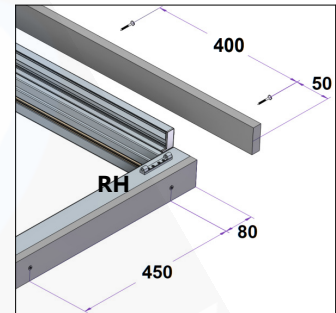

400

50

RH

80

450

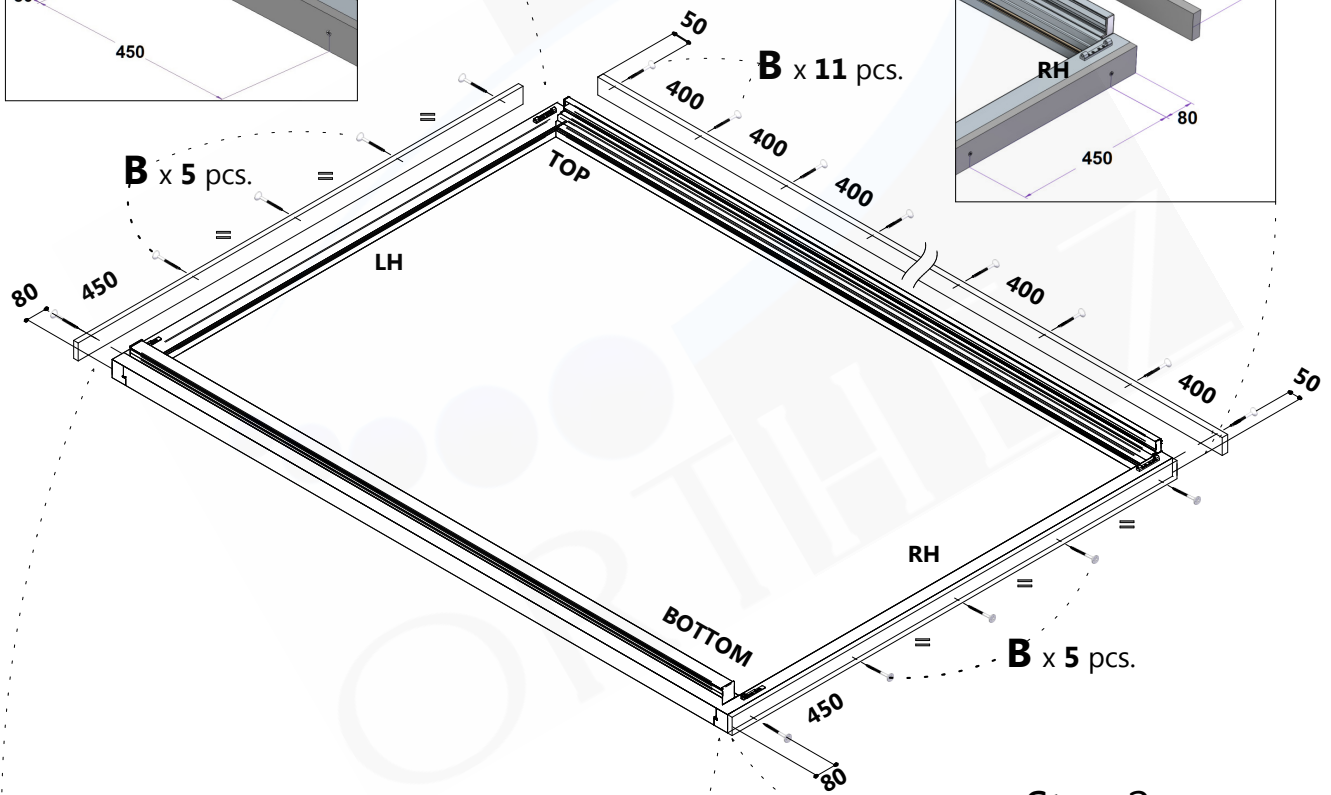

B x 5 pcs.

LH

TOP

B x 11 pcs.

RH

BOTTOM

B x 5 pcs.

Step 2

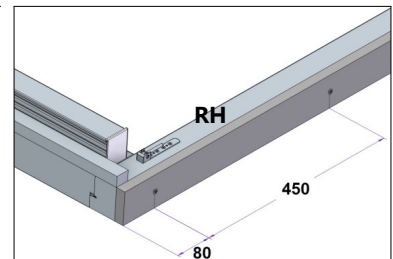
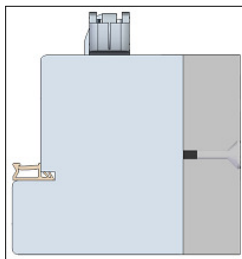
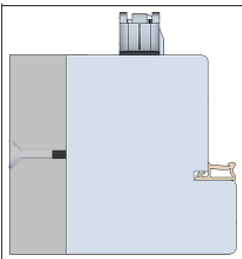

450

RH

80

Door frame installation and sideboard fixing

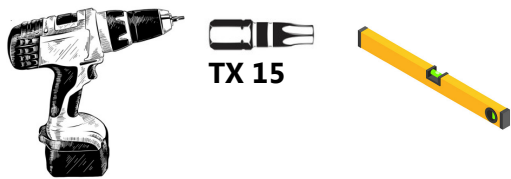

Tools not supplied!

B. 3,5 x 40 mm Screw x 40

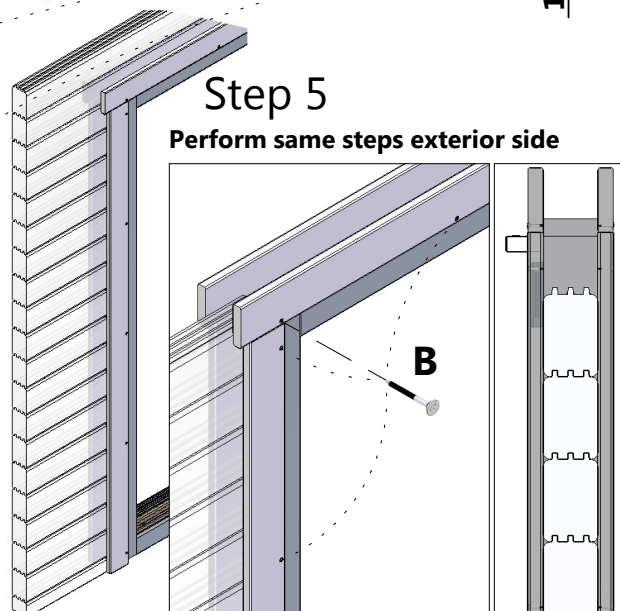
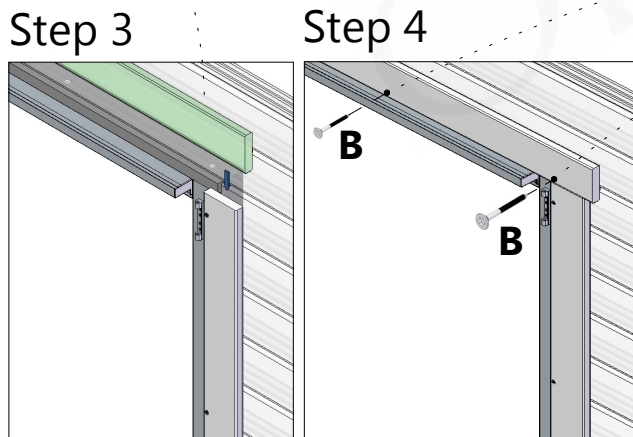
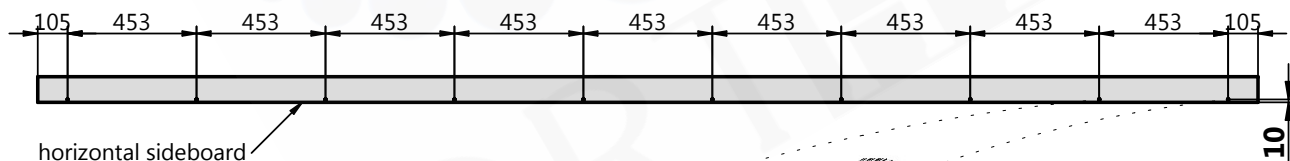
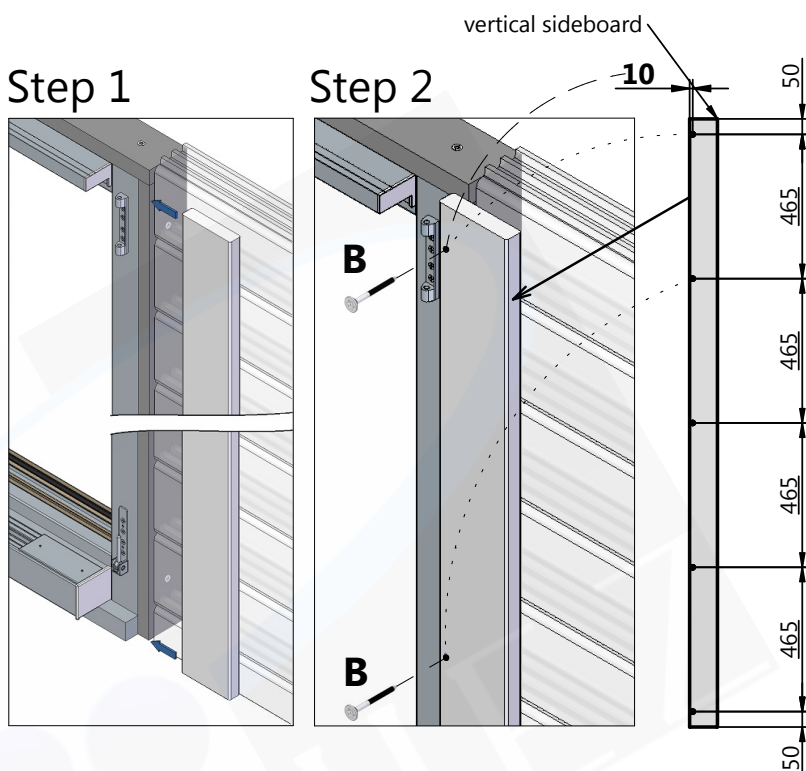
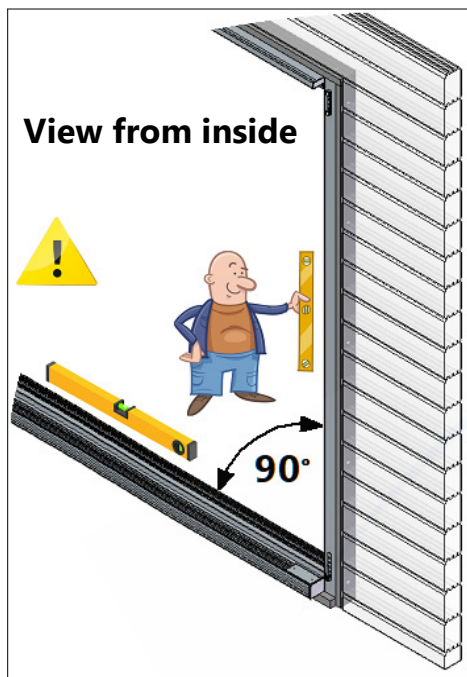

Door sash no. 1 installation



See the page 16

- engaging and disengaging the stay
- adjusting the stay
- adjustment at the rebate corner hinge
- adjusting the pivot rest

View from inside

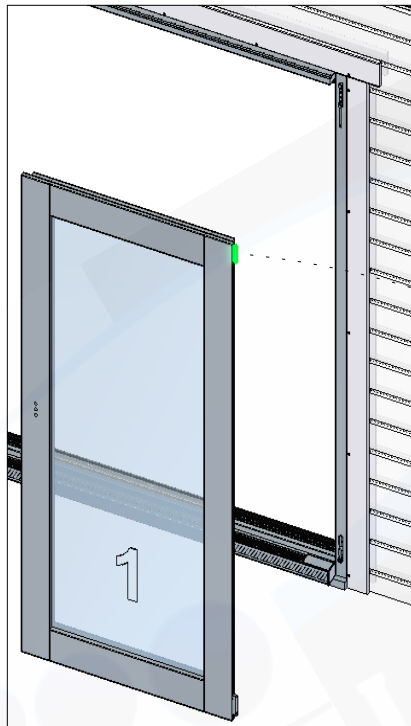
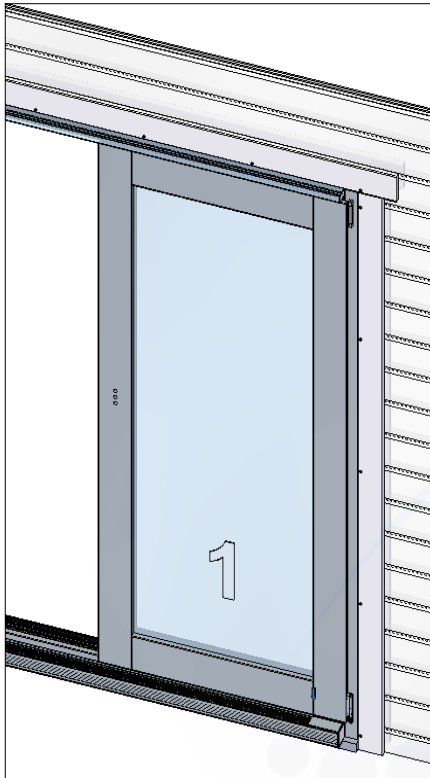

Step 1

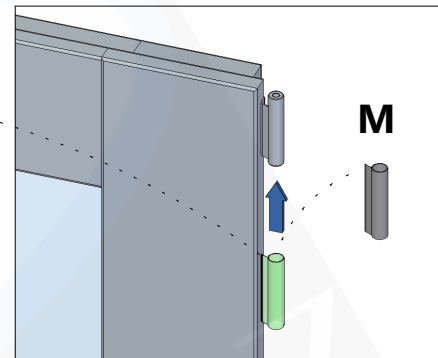

Step 2

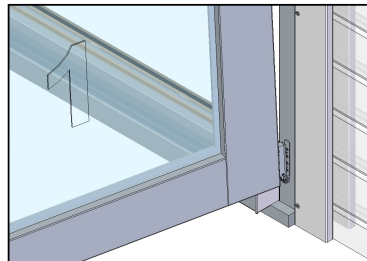
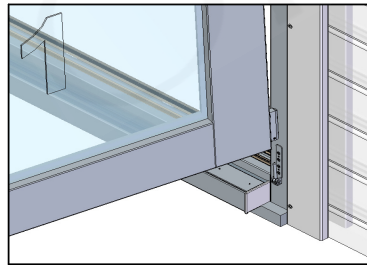
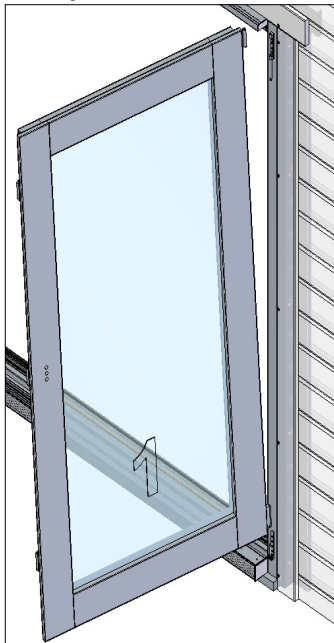

Step 3

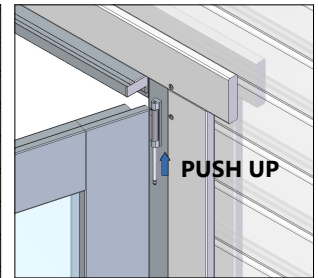
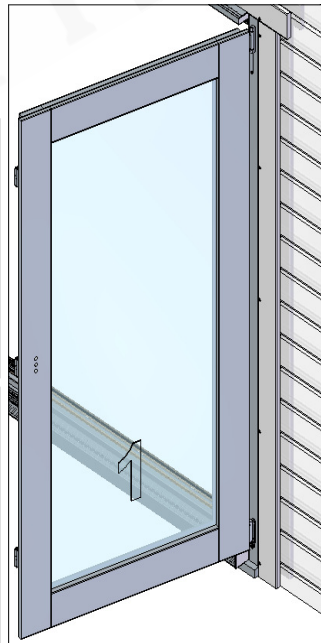

Door sash no. 2 installation



See the page 16

- adjusting the fold and slide hinge
- see additional document *"Installation, operating and maintenance instructions"*

View from outside

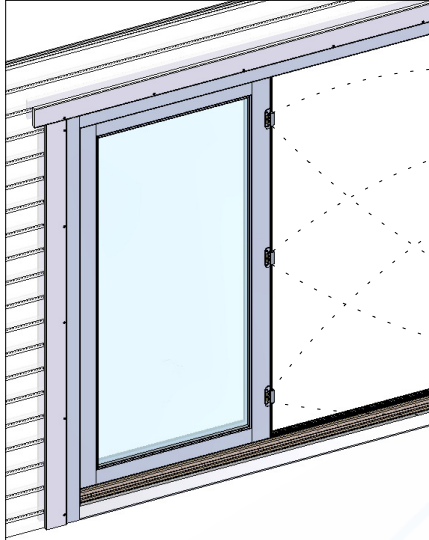

Step 1

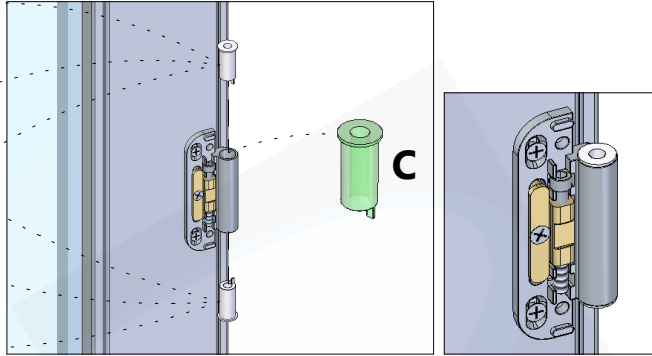

Step 2

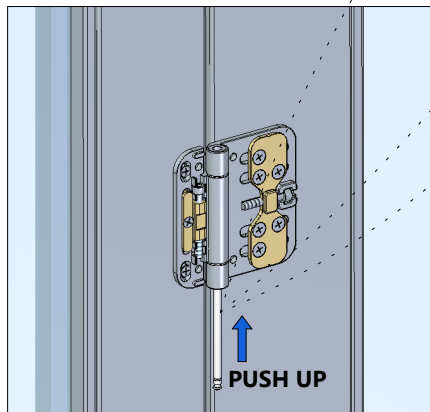
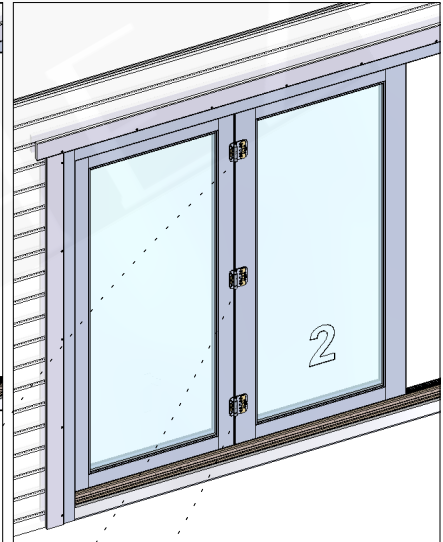

Door sash no. 2 installation continued



See the page 16

- adjusting the bogie and guide roll
- see additional document *"Installation, operating and maintenance instructions"*

View from inside

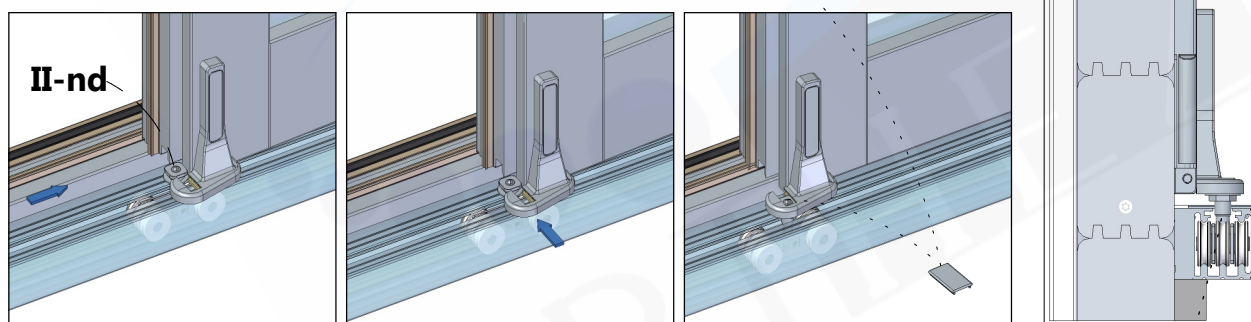
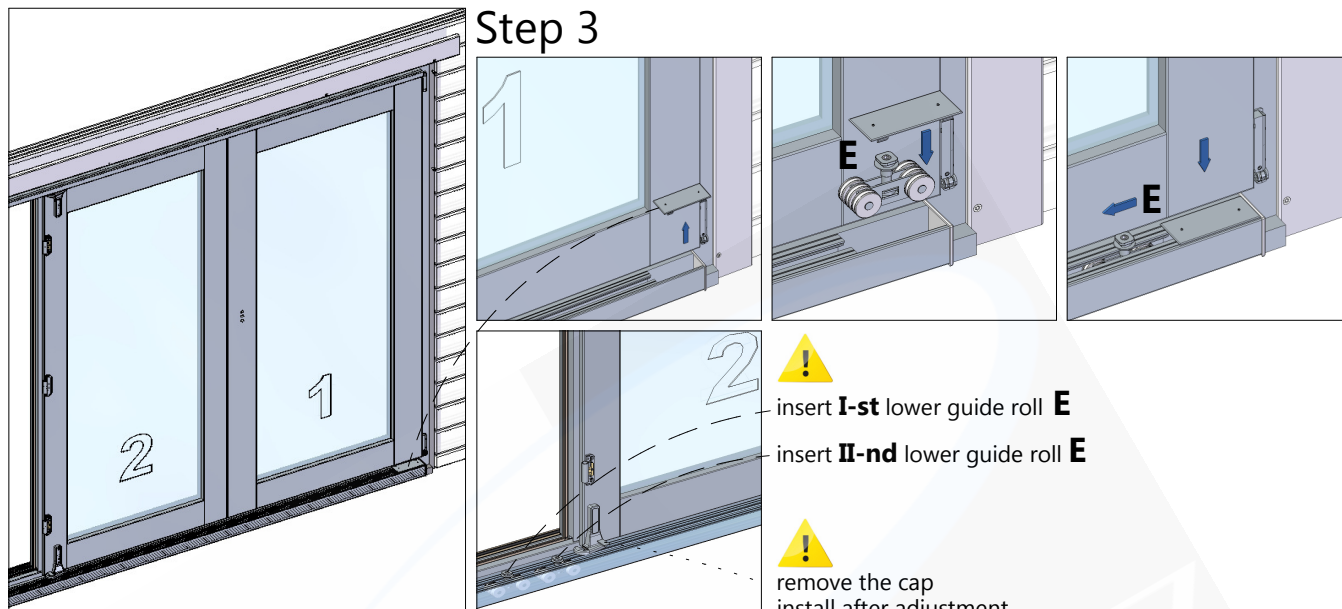

Step 4

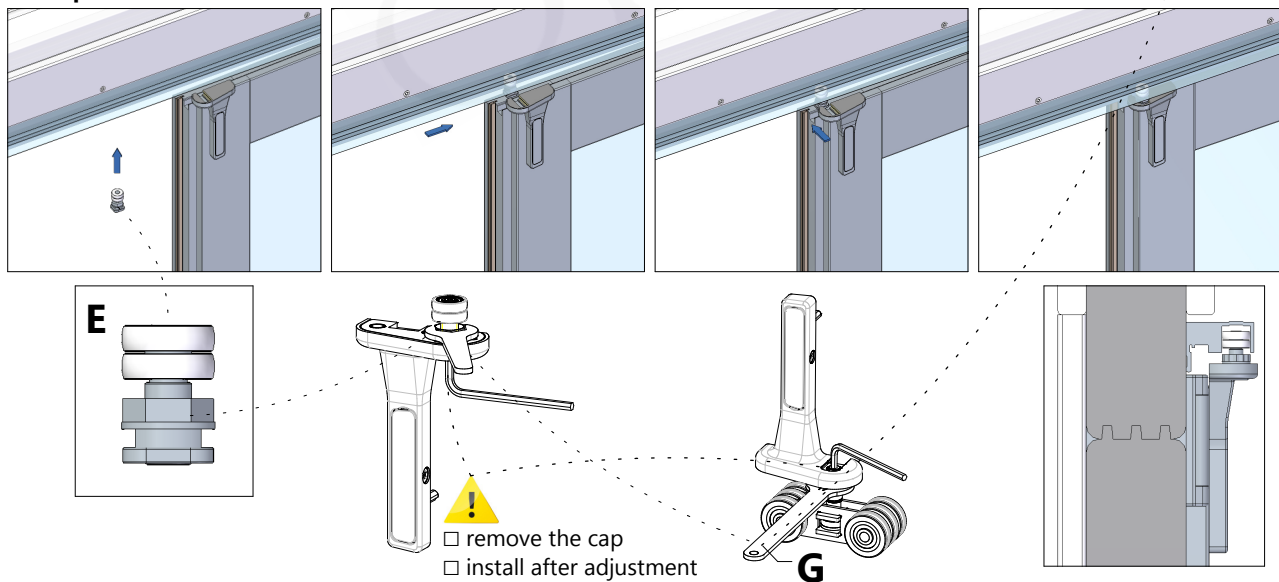

Door sash no. 3 installation



See the page 16

- adjusting the fold and slide hinge
- see additional document *"Installation, operating and maintenance instructions"*

View from inside

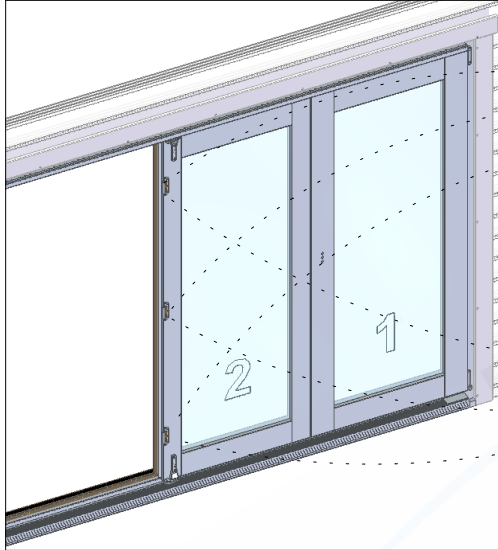

Step 1

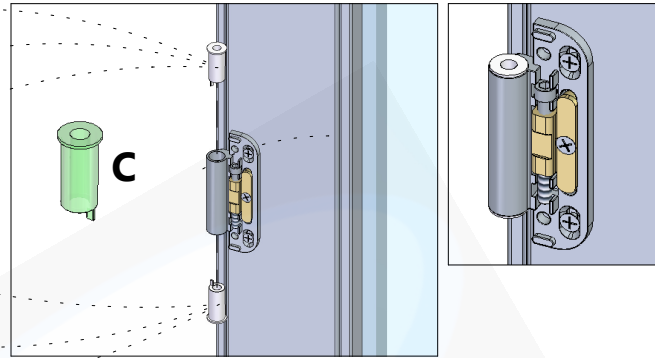

Step 2

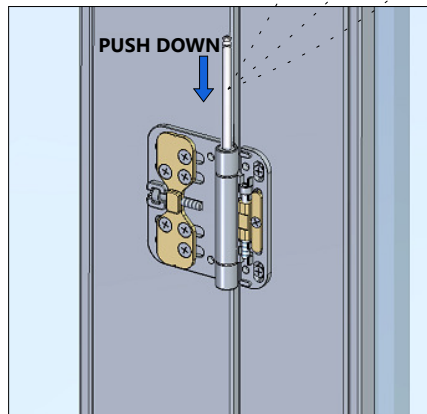

Door sash no. 4 installation



See the page 16

- adjusting the fold and slide hinge
- see additional document *"Installation, operating and maintenance instructions"*

View from outside

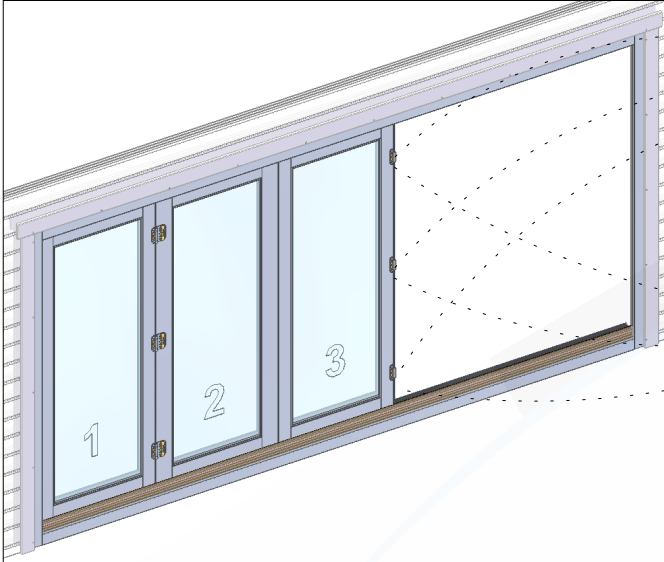

Step 1

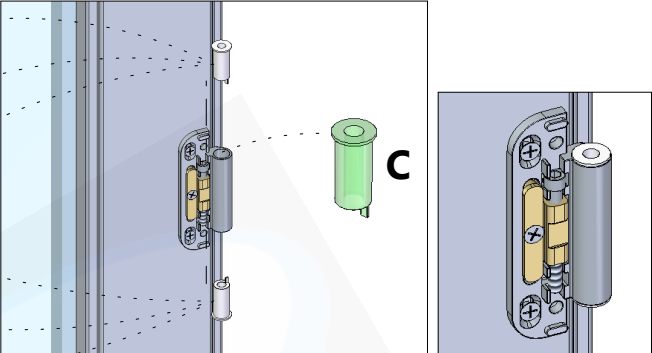

View from outside

Step 2

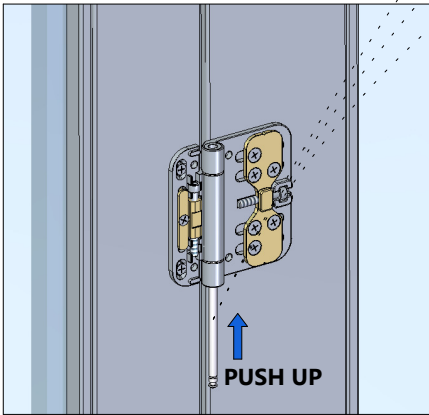

Door sash no. 4 installation continued



See the page 16

- adjusting the bogie and guide roll
- see additional document *"Installation, operating and maintenance instructions"*

View from inside

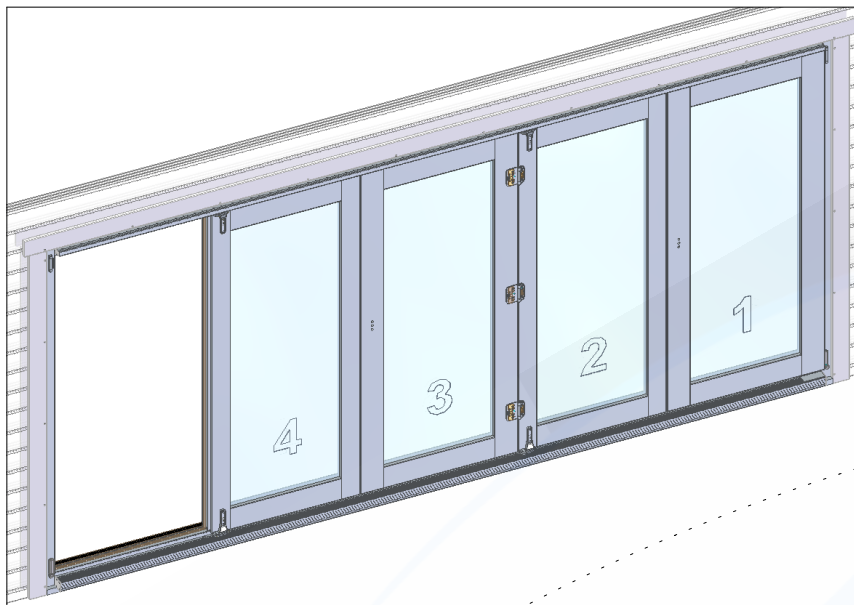

I-st lower guide roll **E**

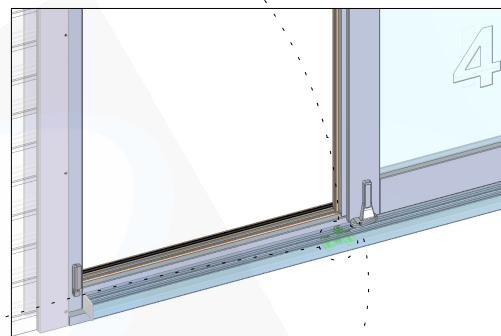

remove the cap
install after adjustment

Step 3

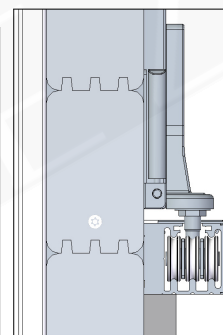
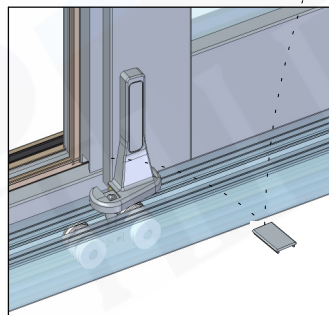
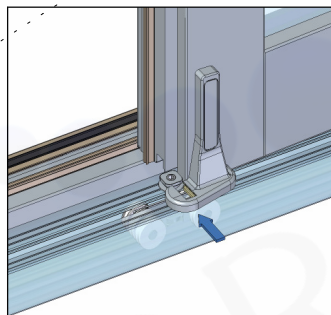
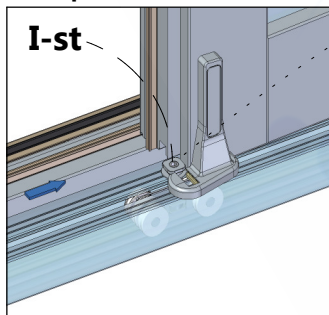

Step 4

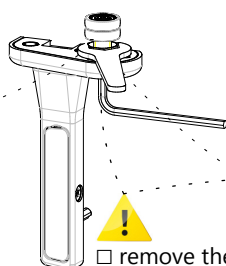
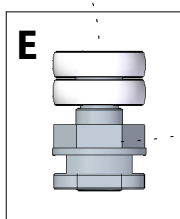
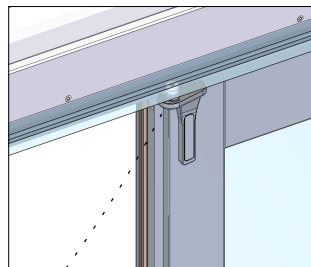
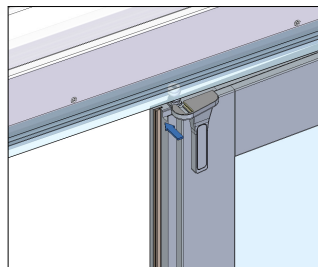
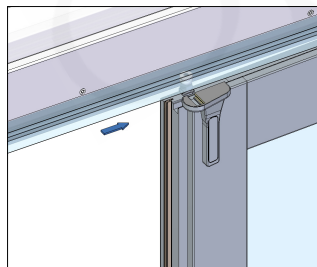
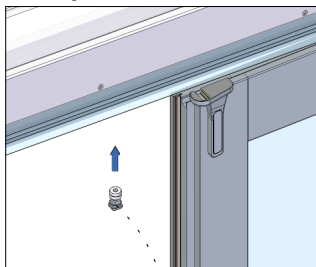

- remove the cap
- install after adjustment

G

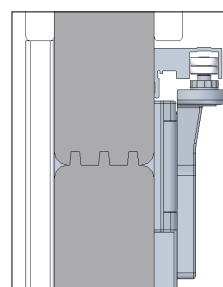

Door sash no. 5 installation



See the page 16

- engaging and disengaging the stay
- adjusting the stay
- adjustment at the rebate corner hinge
- adjusting the pivot rest

View from inside

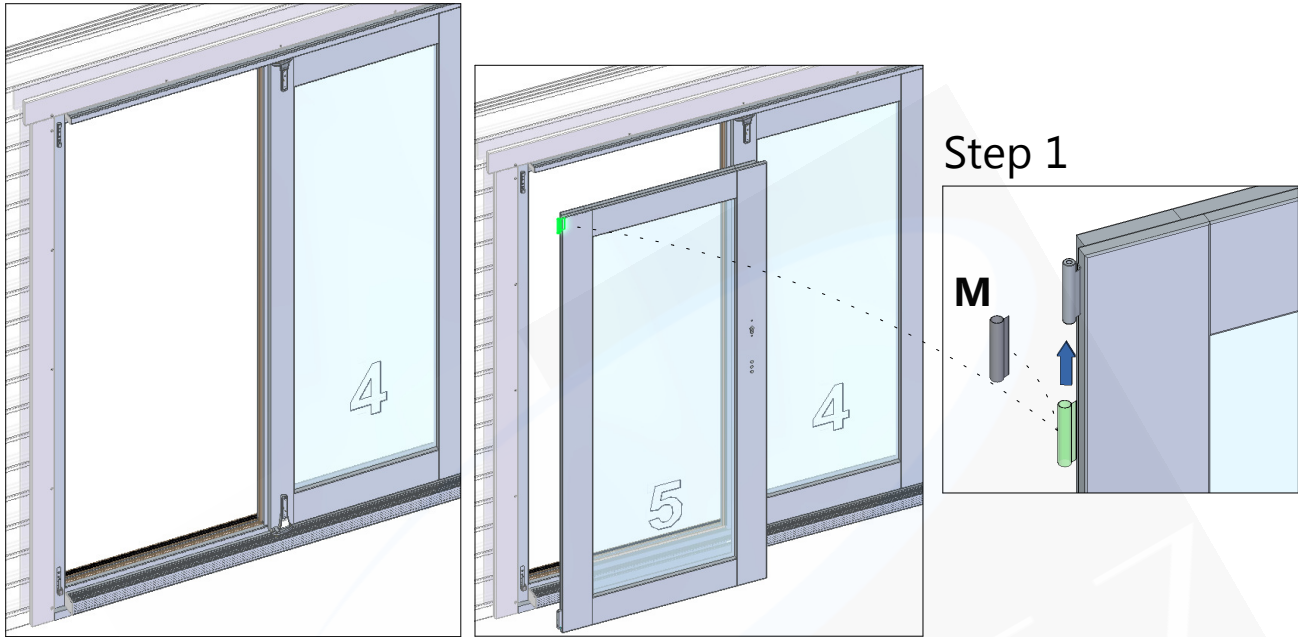

Step 2

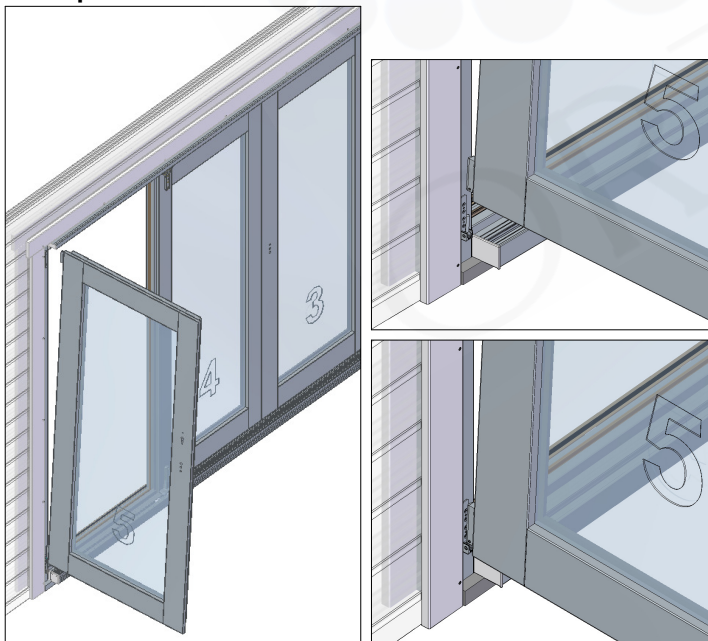

Step 3

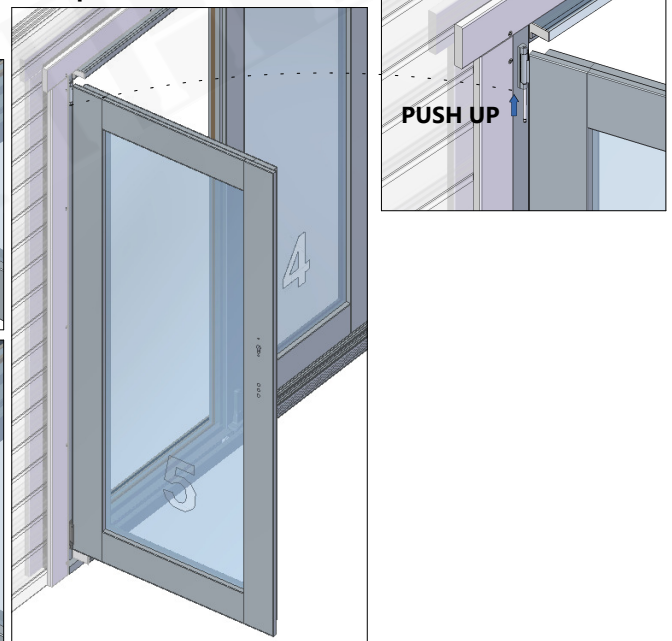

Door handles and lock set installation



Tools not supplied!

View from inside

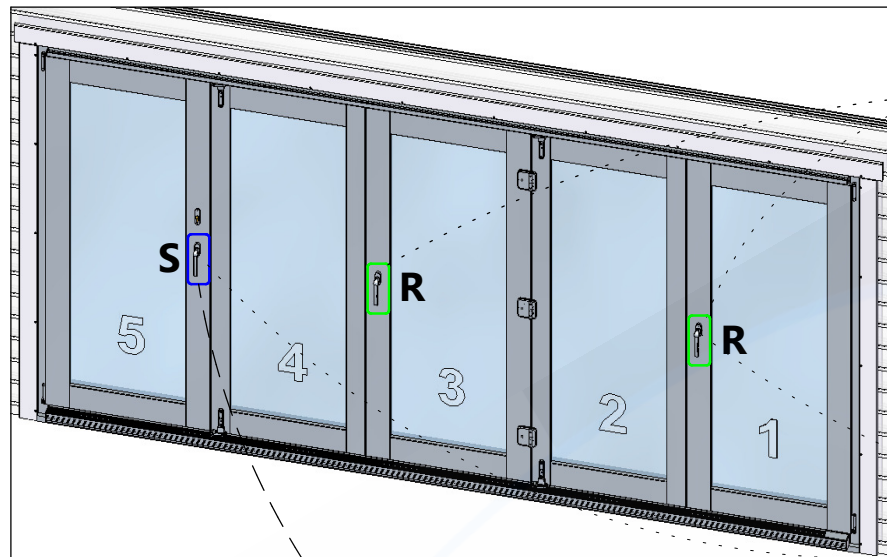

Step 1

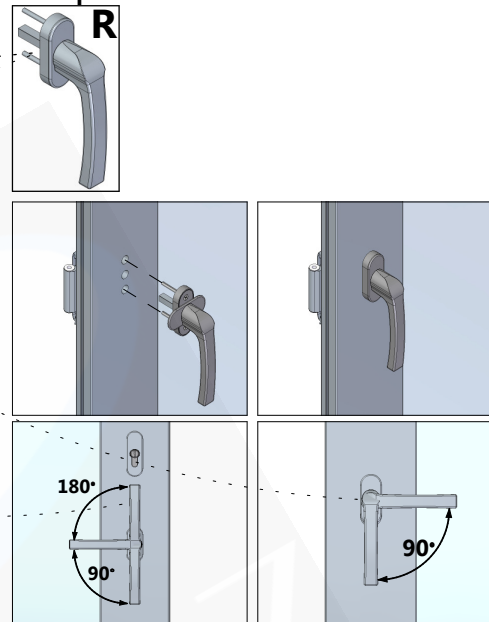

Step 2

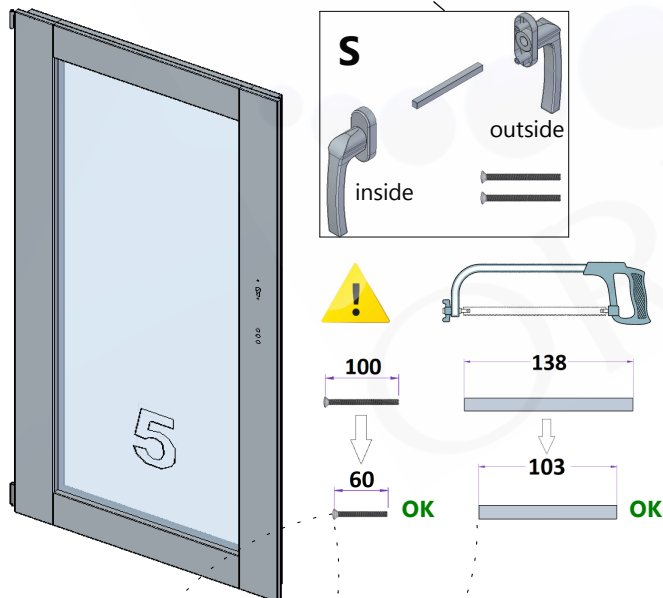

View from outside



Step 3

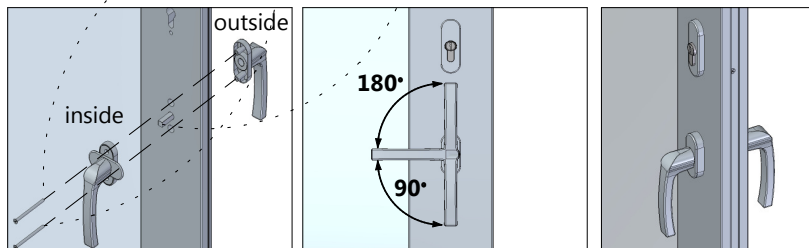
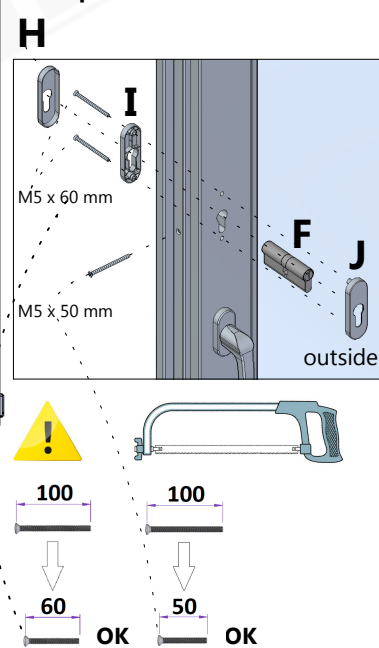

Cover caps installation

View from inside

Step 1

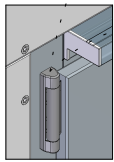
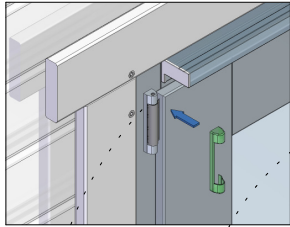

N



O (RH)



P

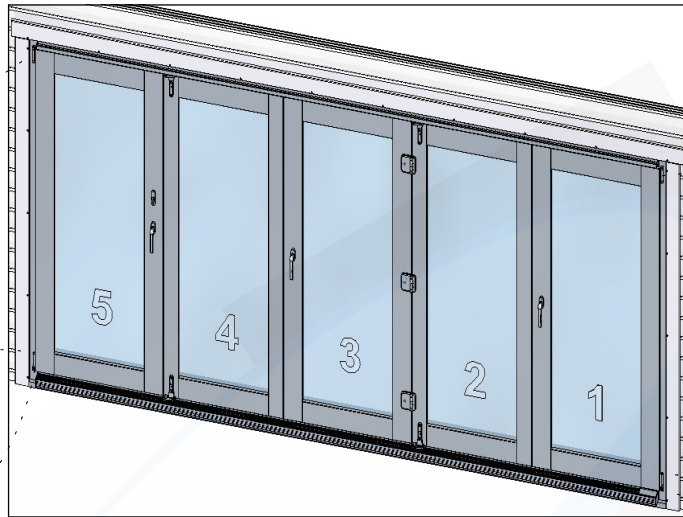
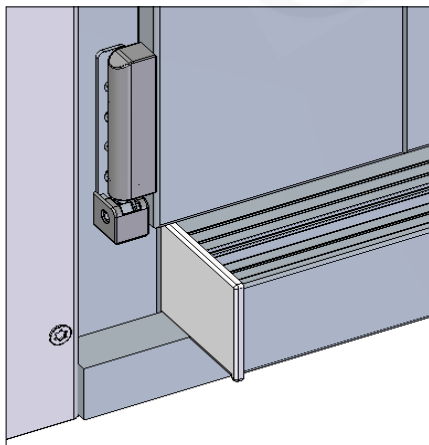
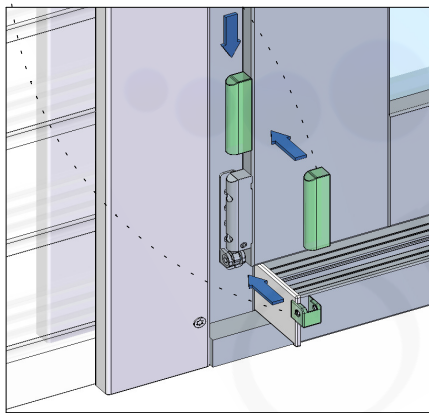

Step 2

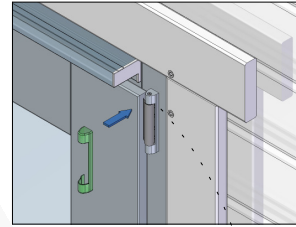

N



O (LH)



P

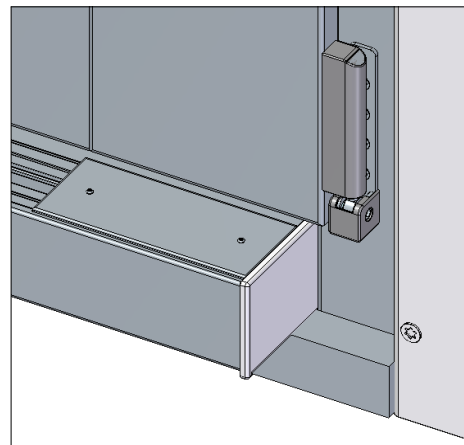
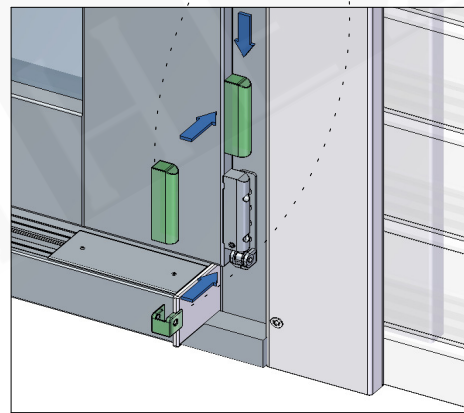

Hardware adjustment



Tools not supplied!

Engaging and disengaging the stay

Adjusting the stay
Setting + 3,5 mm / -3 mm
TX 15

5

1

Adjusting the pivot rest

Setting ± 2 mm
TX 15

Adjustment at the rebate corner-hinge

Setting ± 2 mm
SW 4

Setting ± 1 mm
TX 15

Adjusting the pivot rest

Setting ± 2 mm
TX 15

! See additional document
"Installation, operating and maintenance instructions"

Vertical adjustment on bogie / pivot rest

Vertical adjustment
+ 3,5 mm / -1 mm
SW 4

Loosening and adjusting

- Hold the set bolt using an allen key SW 4
- Loosen and hold the locknut using an open-end spanner size 17
- Adjust vertically with Allen key SW 4

Locking

- Hold the set bolt using an Allen key SW 4
- Firmly tighten locknut with open end spanner size 17

2

Vertical adjustment on bogie and guide roll

Vertical adjustment
+ 3,5 mm / -1 mm
SW 4

Loosening and adjusting

- Hold the set bolt using an allen key SW 4
- Loosen and hold the locknut using an open-end spanner size 17
- Adjust vertically with Allen key SW 4

Locking

- Hold the set bolt using an Allen key SW 4
- Firmly tighten locknut with open end spanner size 17

Loosen screws for vertical adjustment

SW 4

4

Loosen screws for horizontal adjustment

SW 4

Fixing / removing the sash hinge cover

For attachment / removal of sash-hinge covers, the setscrews on the back must be tightened / loosened. Open sashes to access screws, if the F&S unit is already installed.

Cover caps installation



See the page 16

- fixing / removing the sash-hinge cover
- perform same steps at interior side

Tools not supplied!

SW 2

View from outside

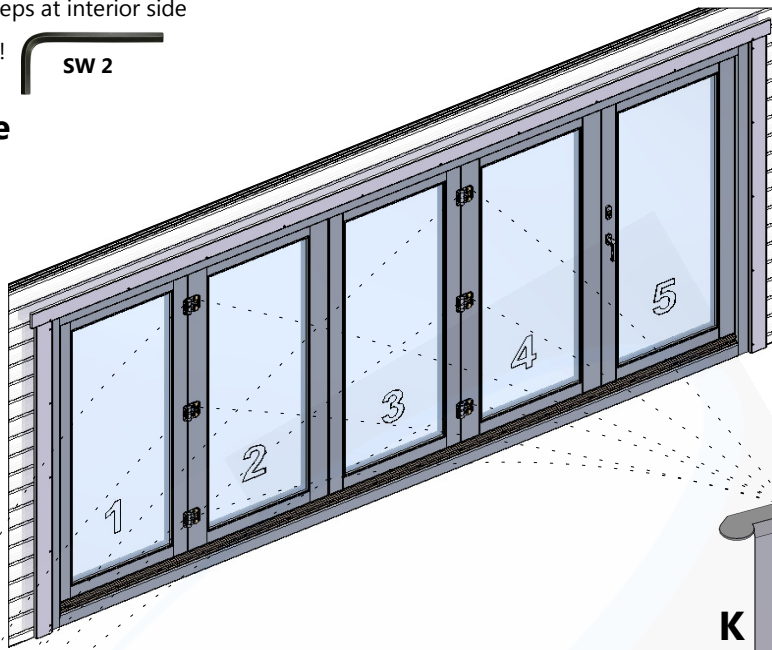

Step 1

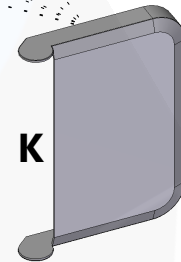

install cover caps after fine adjustment

Step 2

L

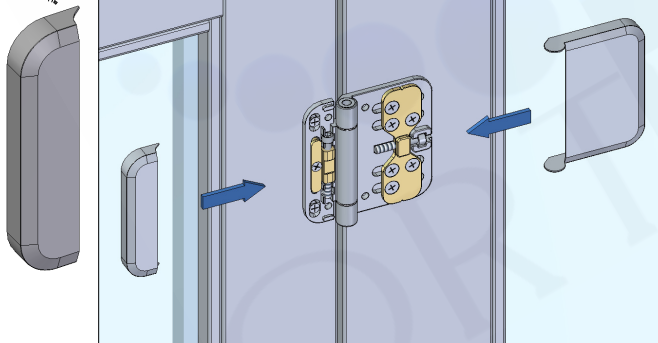

Installing the hinge cover

- Open the Fold&Slide system so the sashes are at roughly 90° to one another. This allows the set screws of the hinges to be accessed from the side opposite to the hinges.
- Push the large cover from the hinge side completely onto the hinge.
- To fasten the cover to the hinge, screw in the two set screws (see illustration) completely by turning them clockwise with a hexagon spanner.

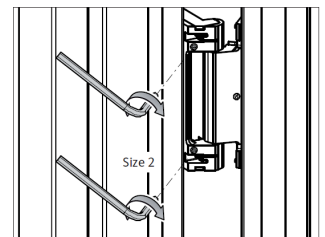
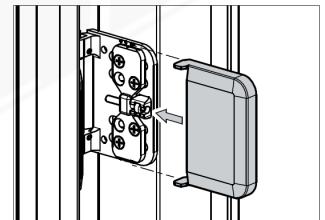

- Push the small cover completely onto the hinge from the hinge side.

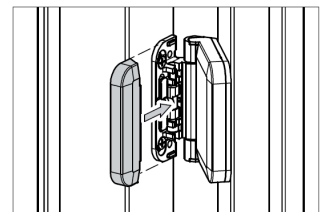

- To fasten the cover to the hinge, screw in the set screw (see illustration) completely by turning it clockwise with a hexagon spanner.

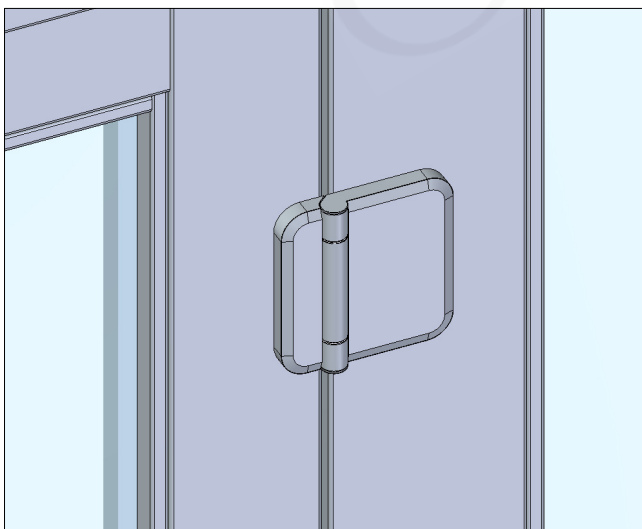
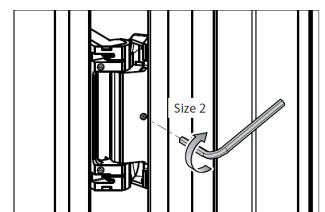

Operation of doors



- Use door 5 independently as a daily access door.
- Close door 5 by turning handle 90 degrees downwards, for locking turn the key clockwise.
Turn the handle 180 degrees to tilt-open door 5.
- Close doors 1, 2 3 and 4 by turning the inside handle 90 degrees downwards so the doors then lock.

View from inside (inward opening)

