

Kasai B 70
Art. Nr.7011741

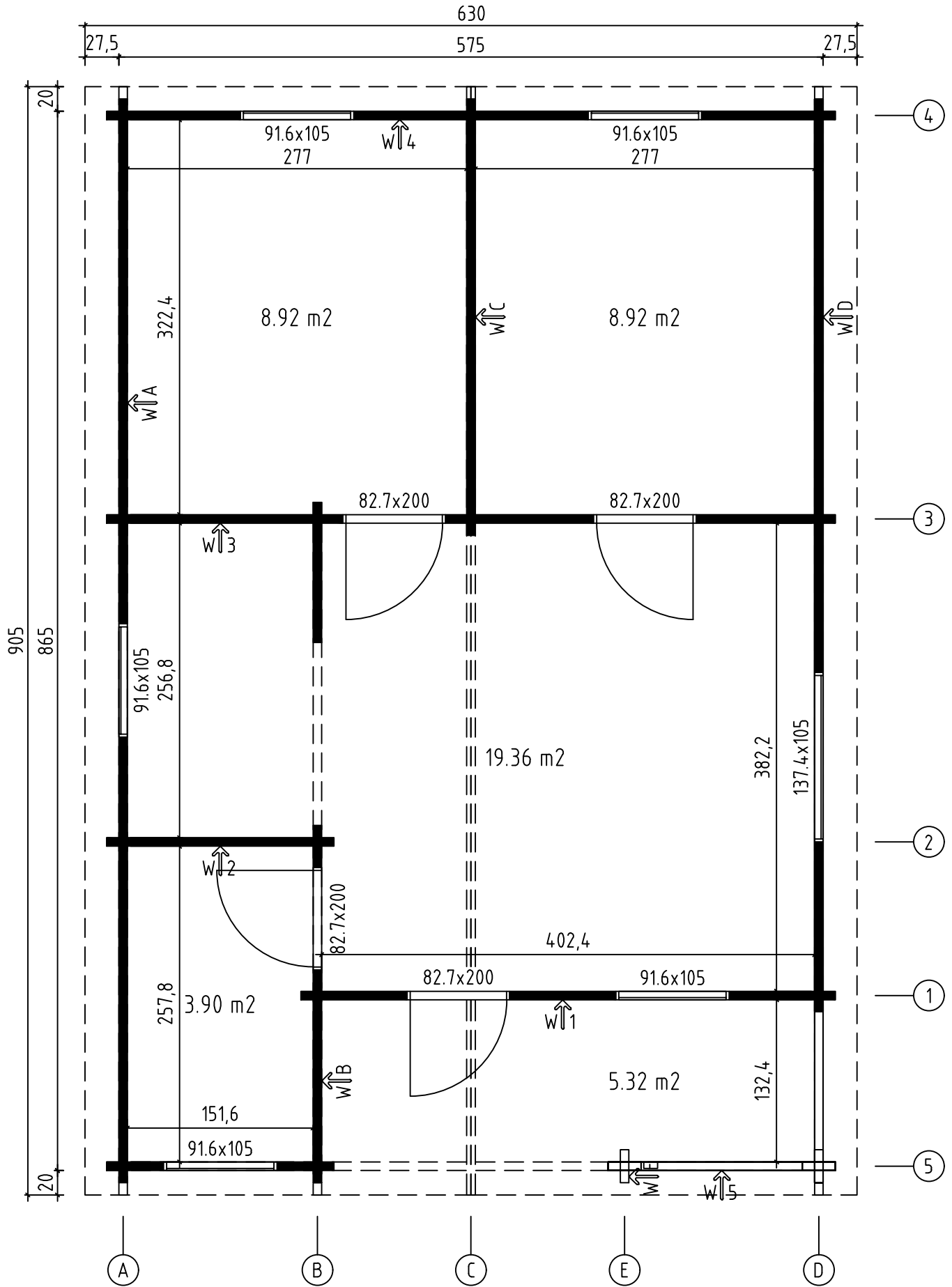

Kasai B 70, Art.Nr.7011741
 GROUNDPLAN - GRUNDPLAN - PLAN DE MASSE



Kasai B 70, Art.Nr.7011741
 FOUNDATION - FUNDAMENT - FONDATION

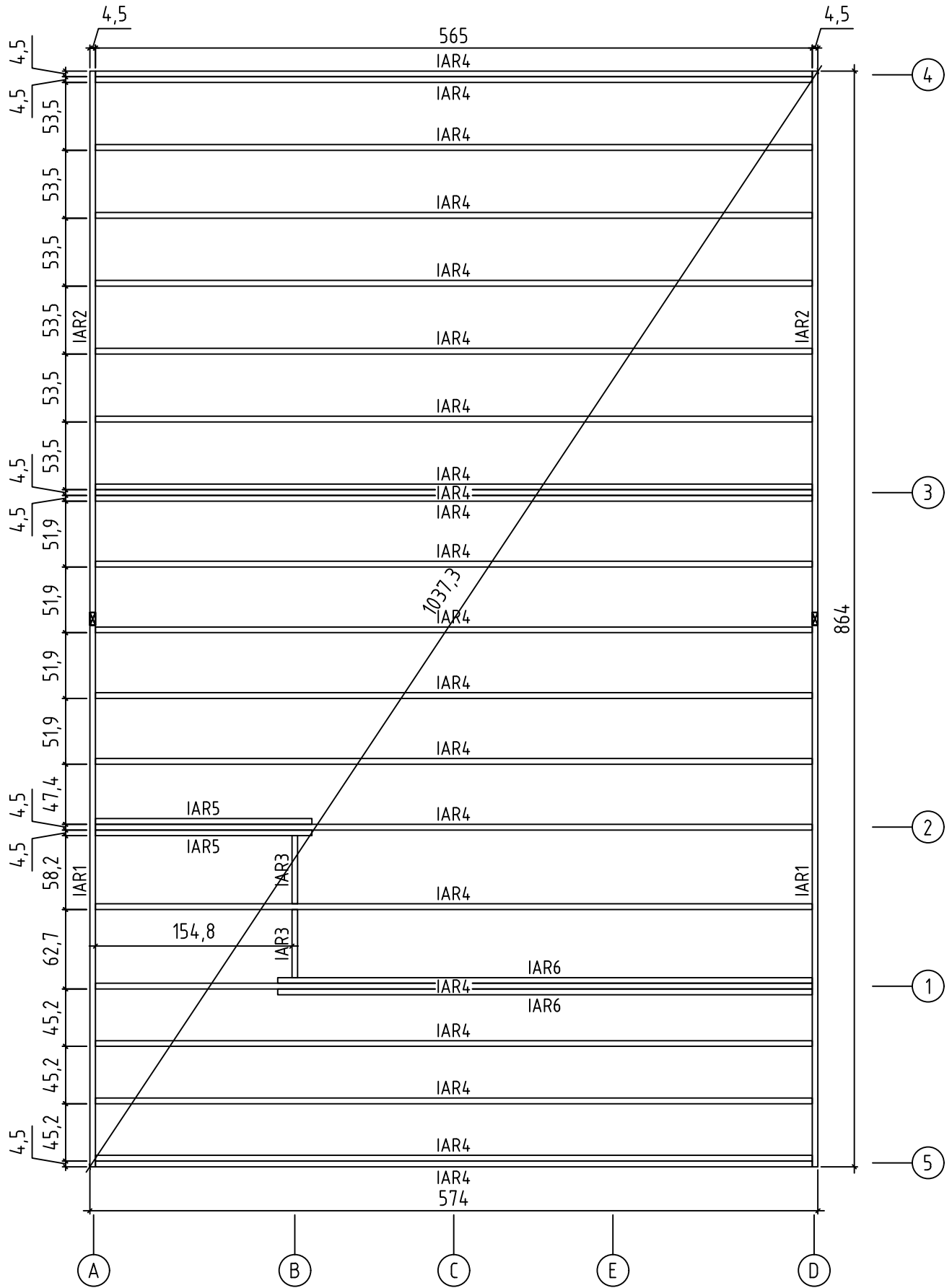

Kasai B 70, Art.Nr.7011741
ROOF BEAM - DACHBALKEN - PANNE DE TOIT

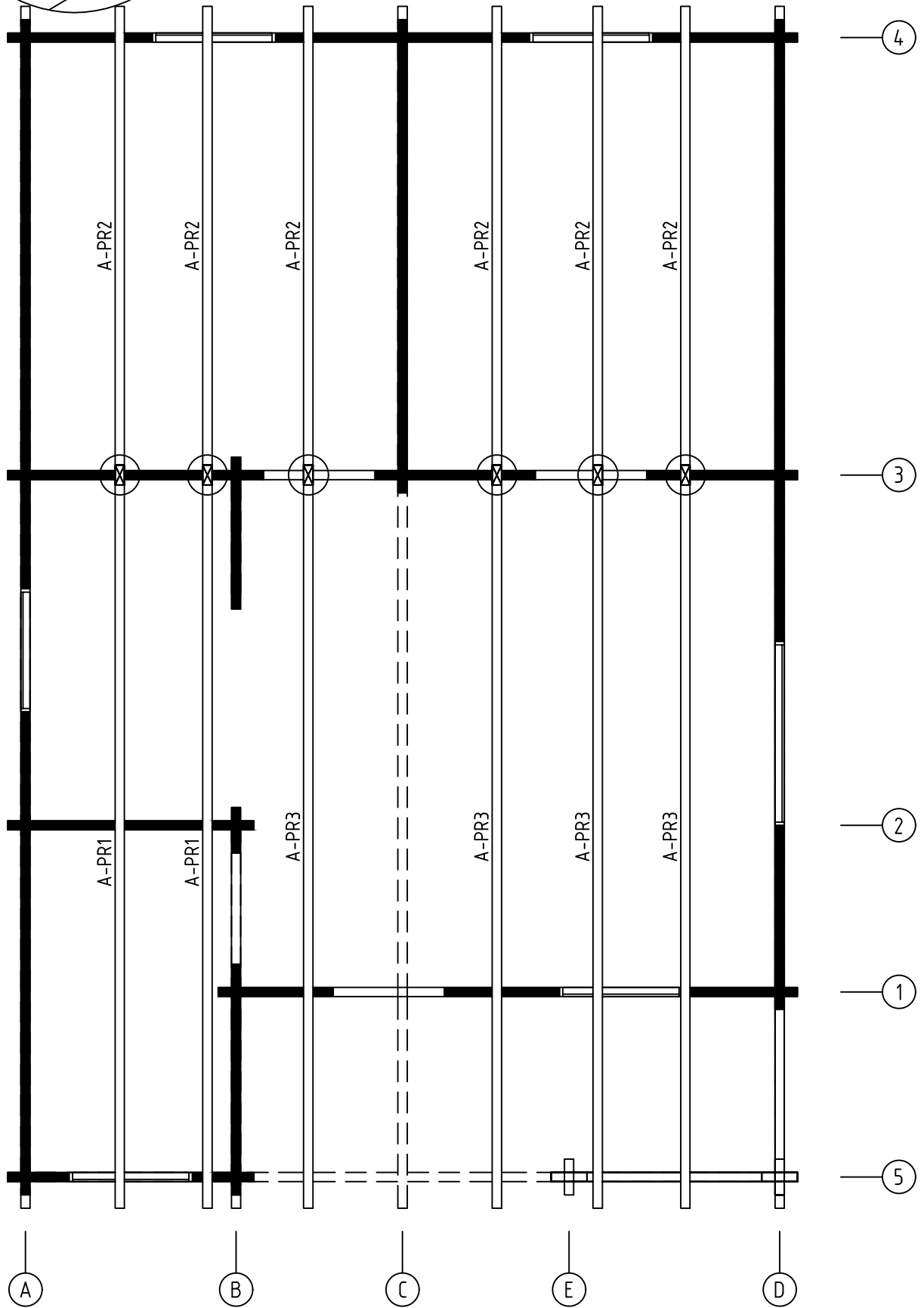
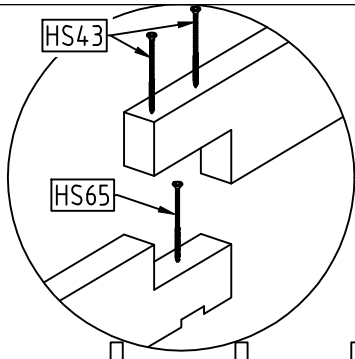

Kasai B 70, Art.Nr.7011741
FLOOR BOARDS - FUSSBODENBRETTER - LAME DE PLANCHER
TERRACE BOARDS - TERRASSENBRETTER - PLANCHER DE TERRASSE

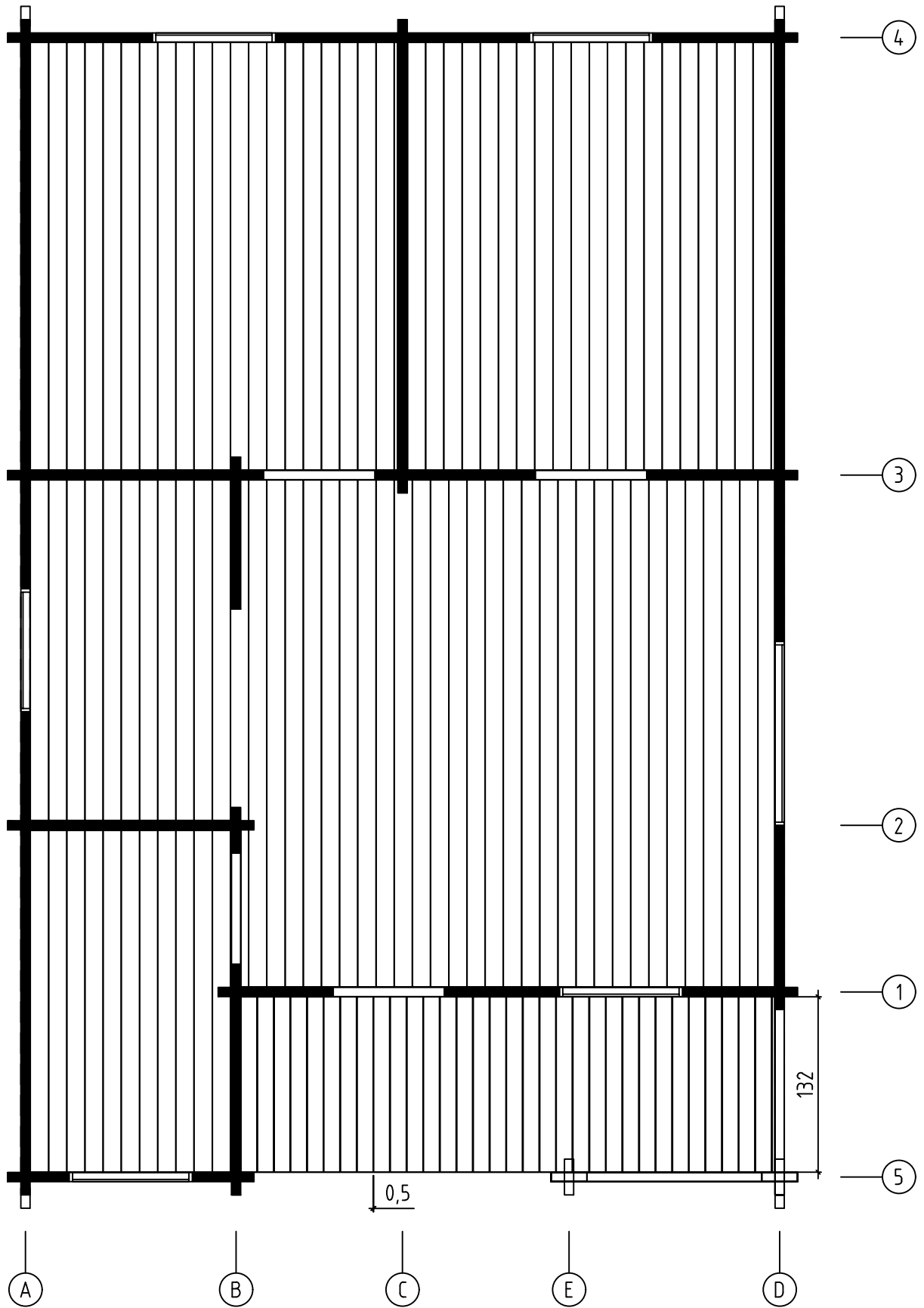

Kasai B 70, Art.Nr.7011741

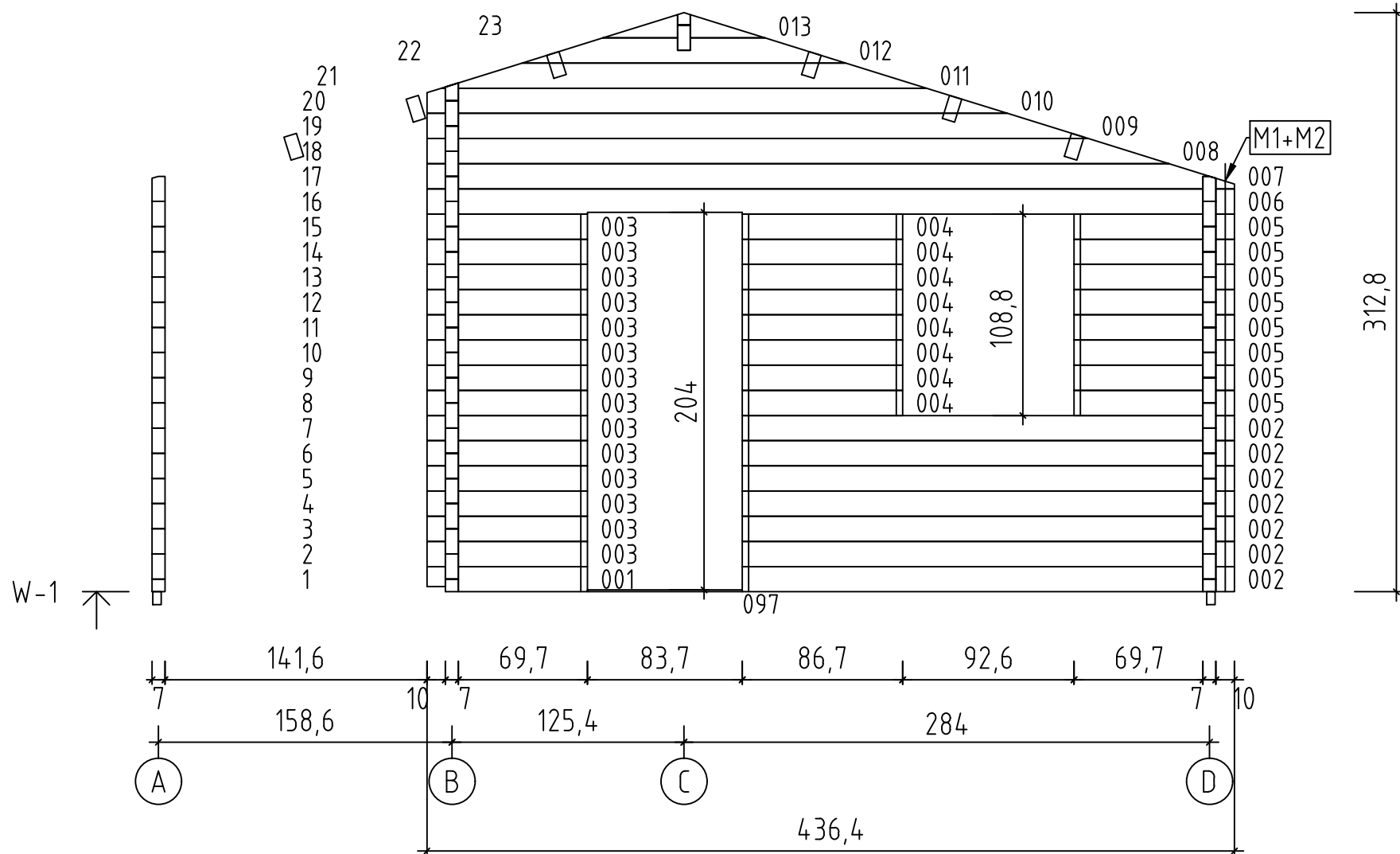

Kasai B 70, Art.Nr.7011741

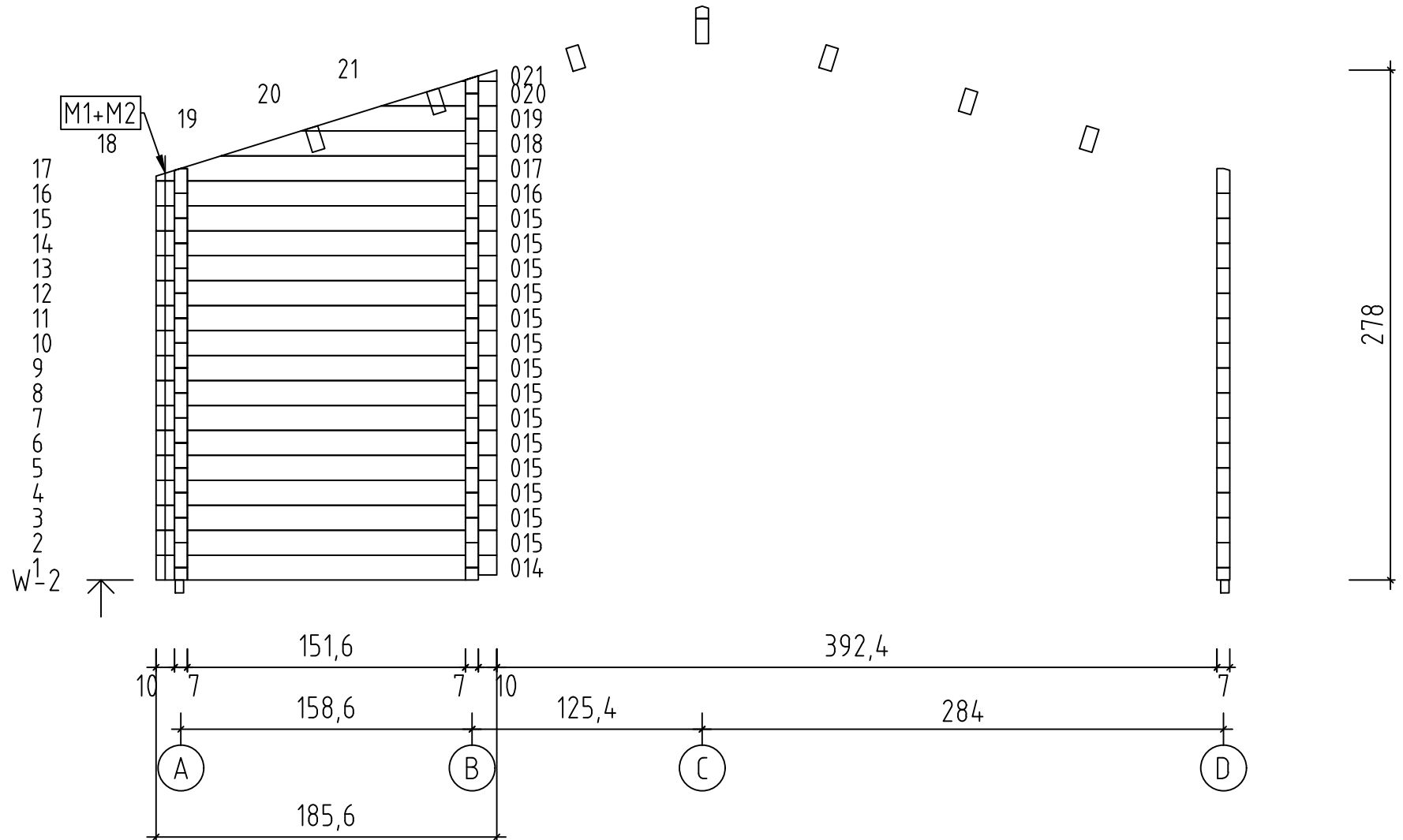

Kasai B 70, Art.Nr.7011741

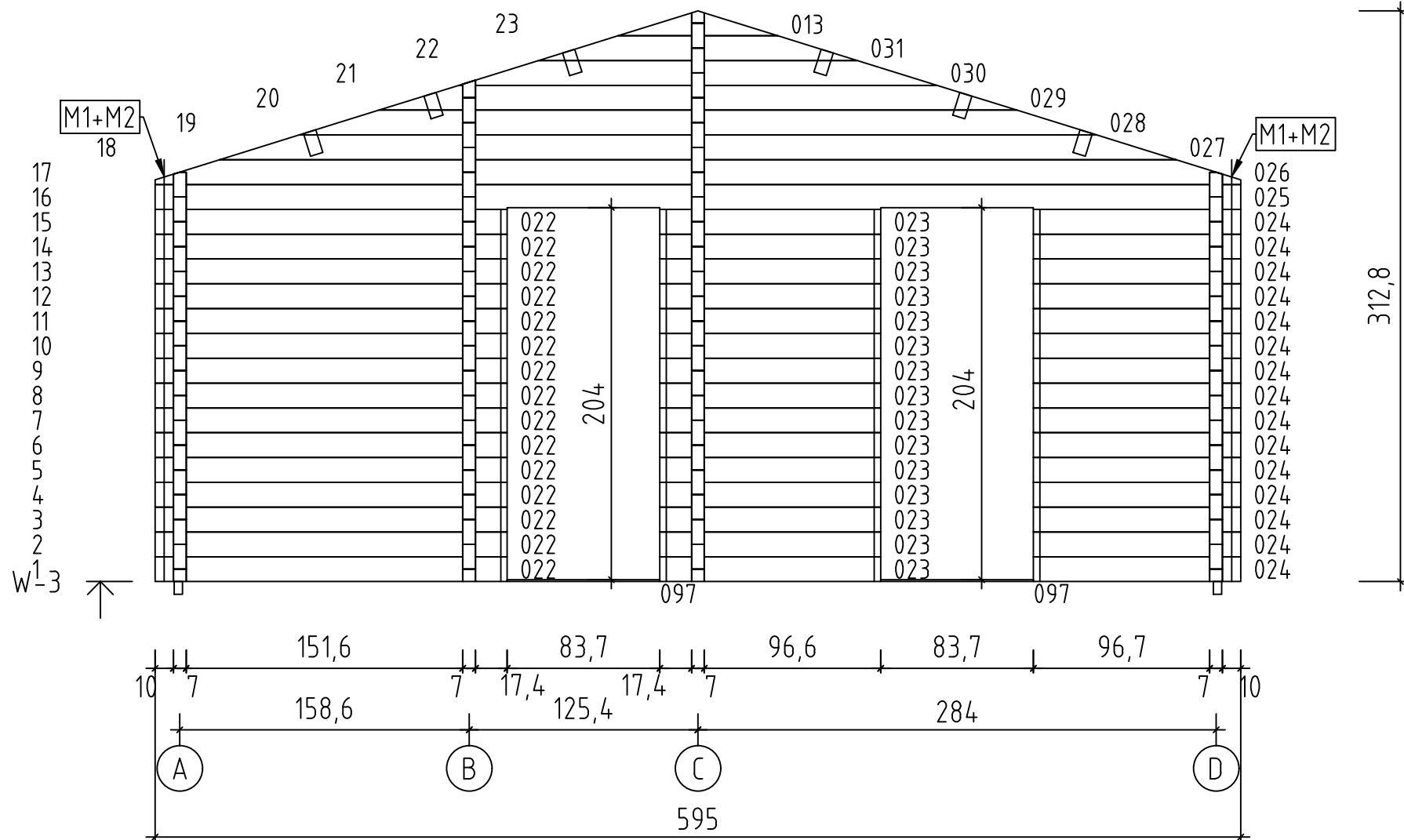

Kasai B 70, Art.Nr.7011741

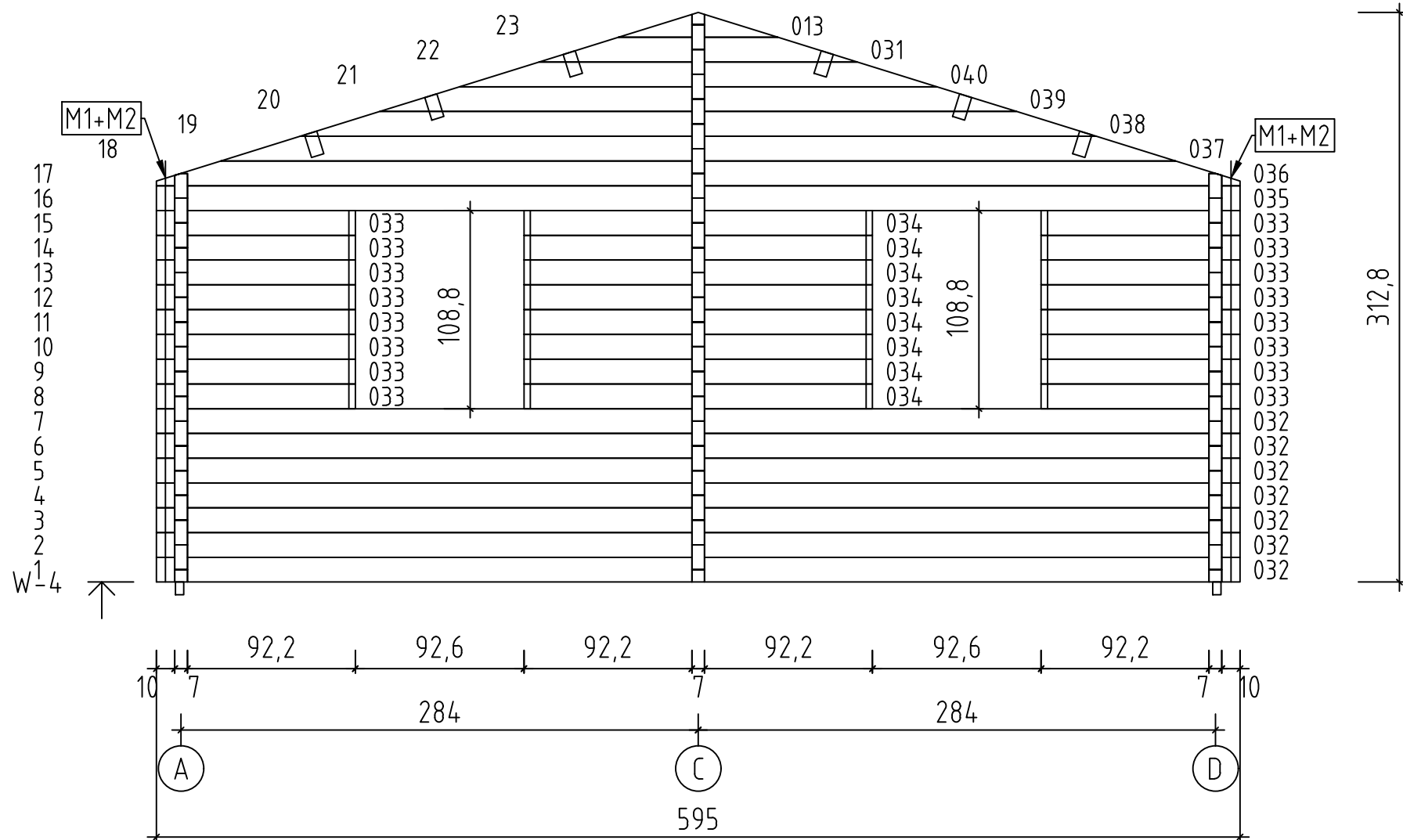

Kasai B 70, Art.Nr.7011741

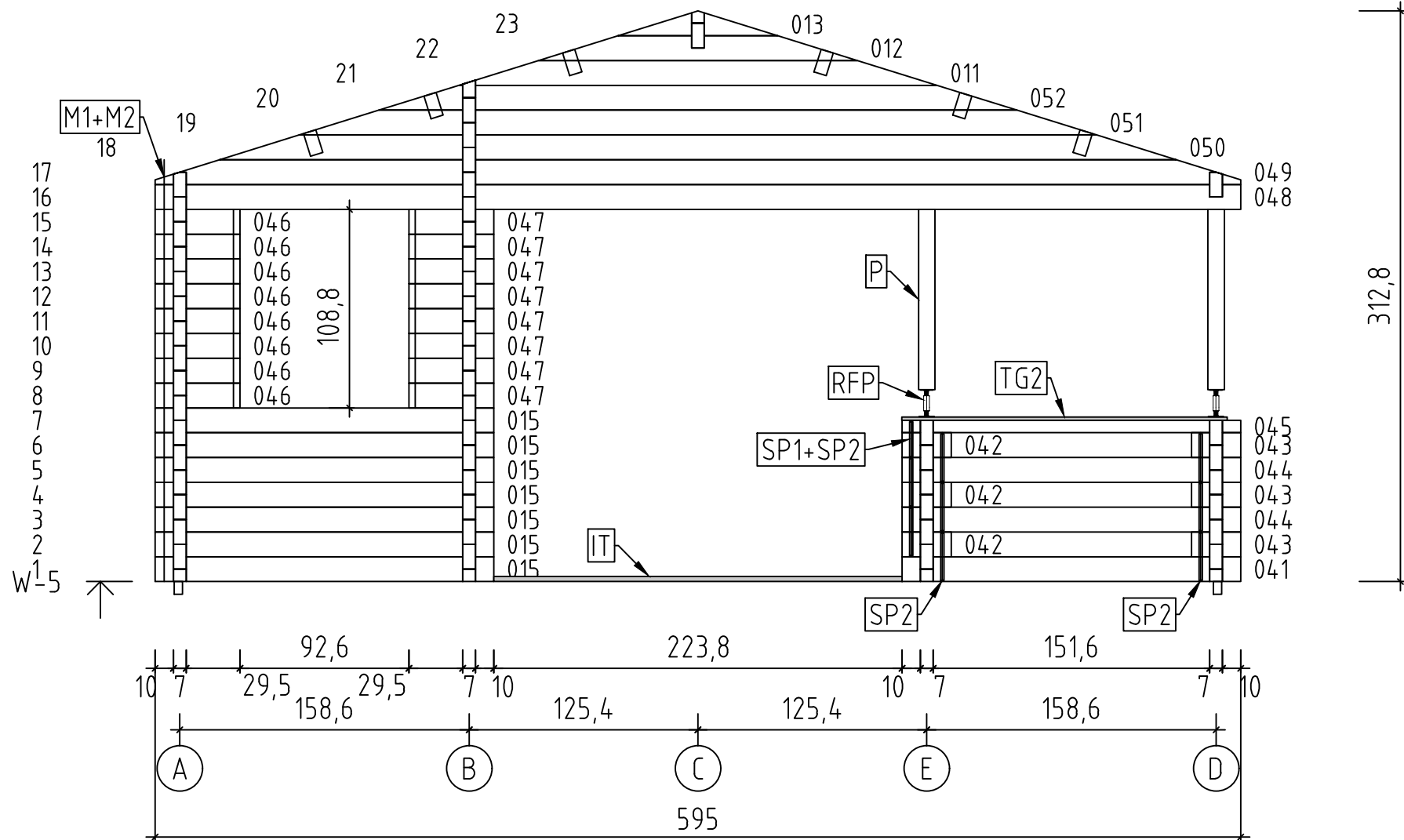

Kasai B 70, Art.Nr.7011741

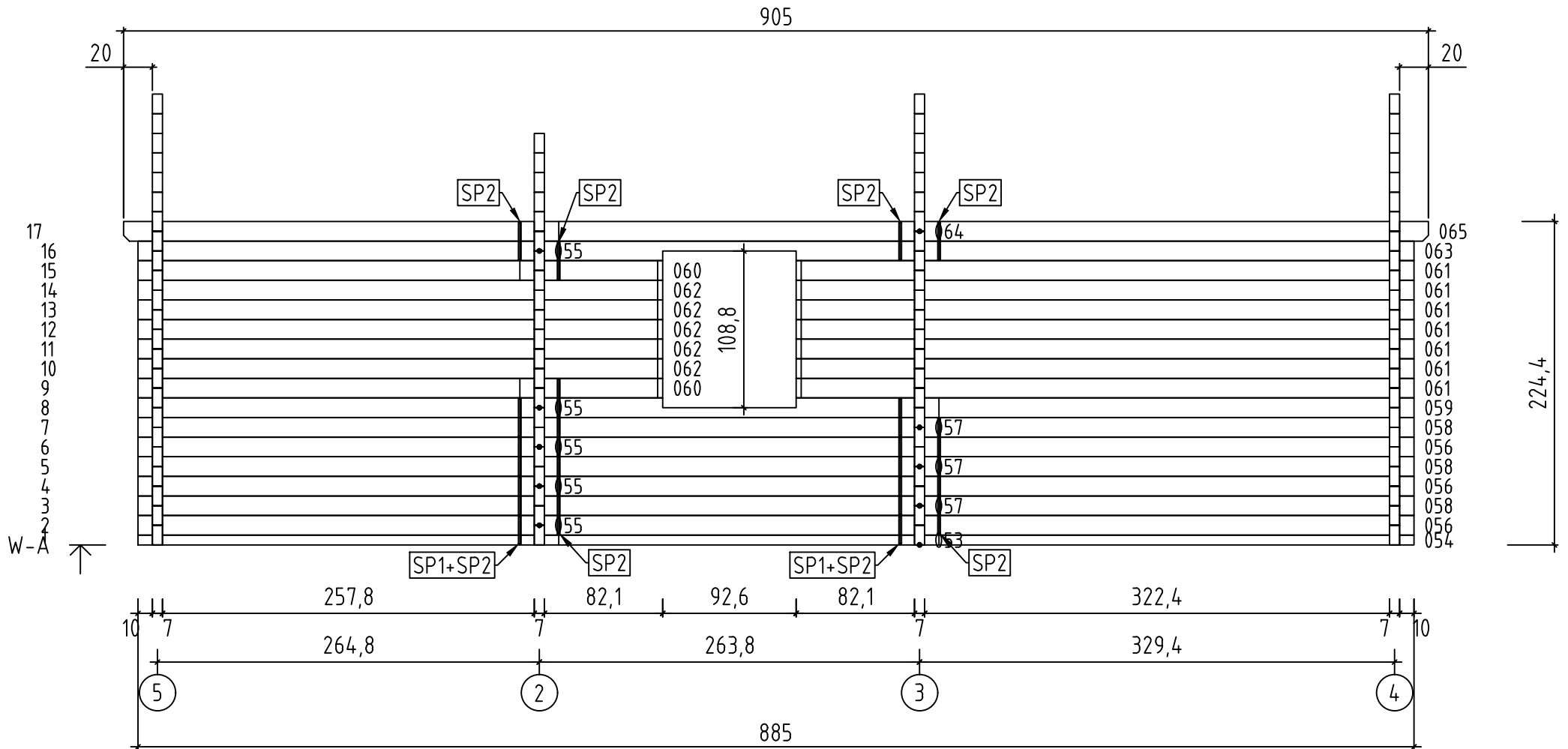

Kasai B 70, Art.Nr.7011741

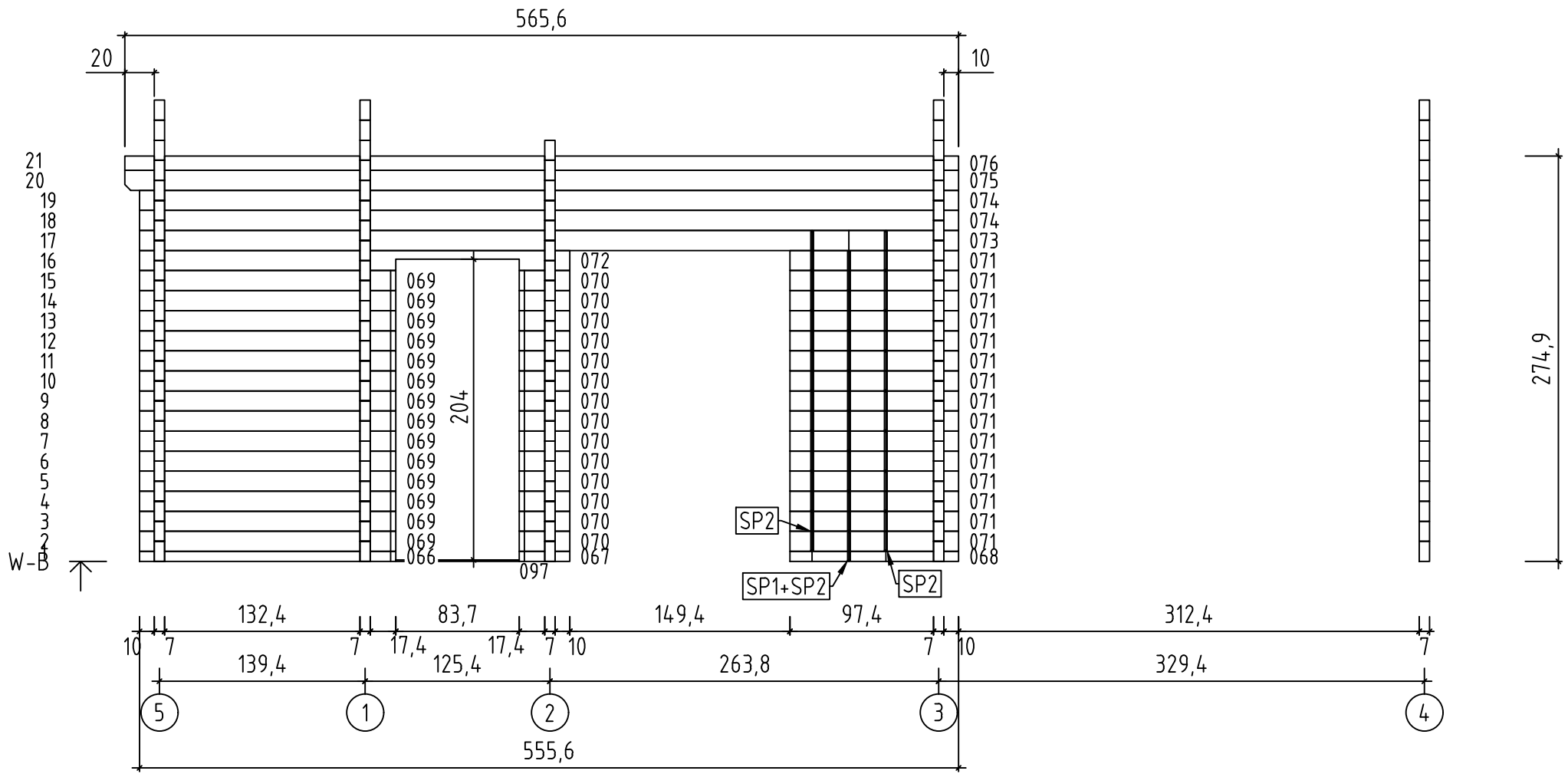

Kasai B 70, Art.Nr.7011741

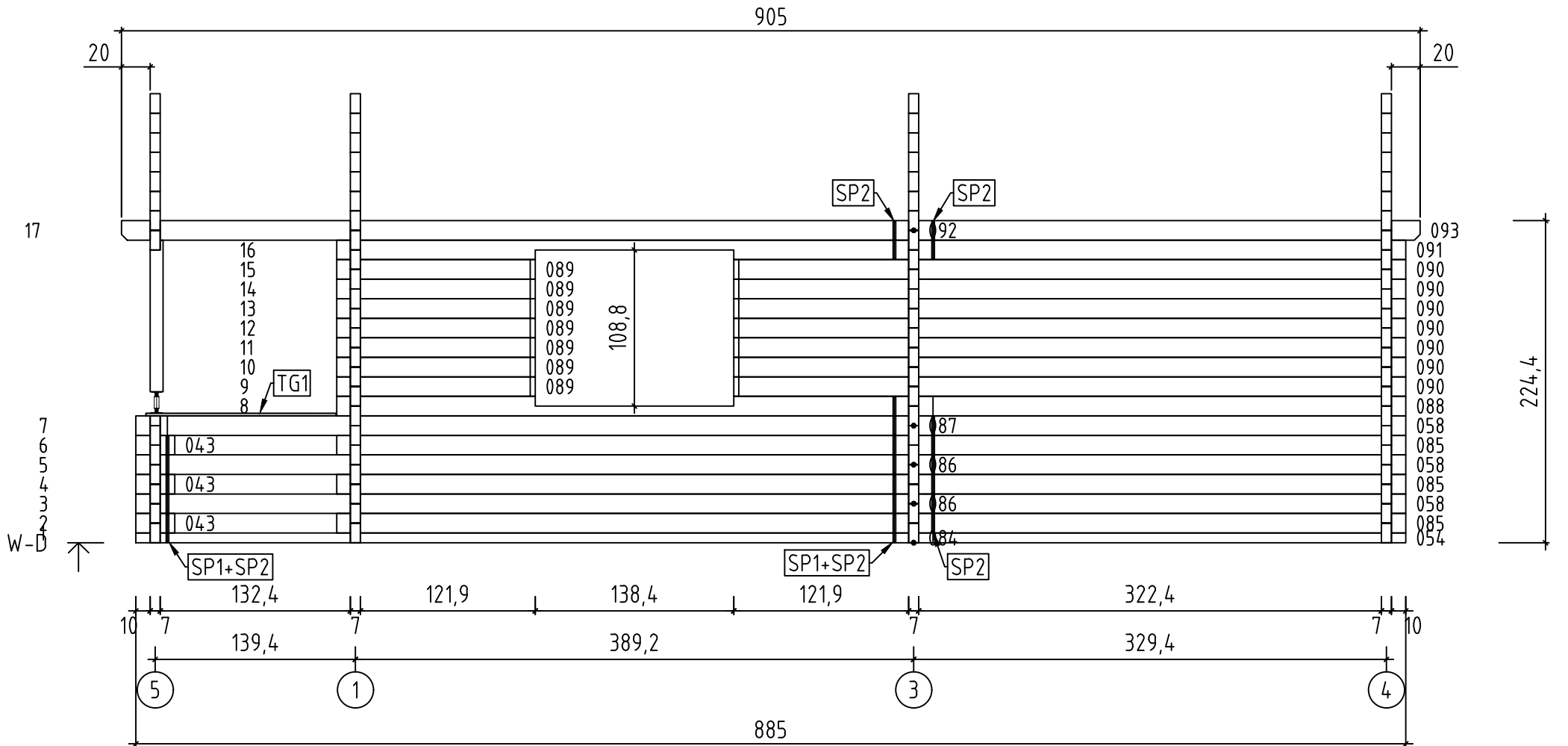



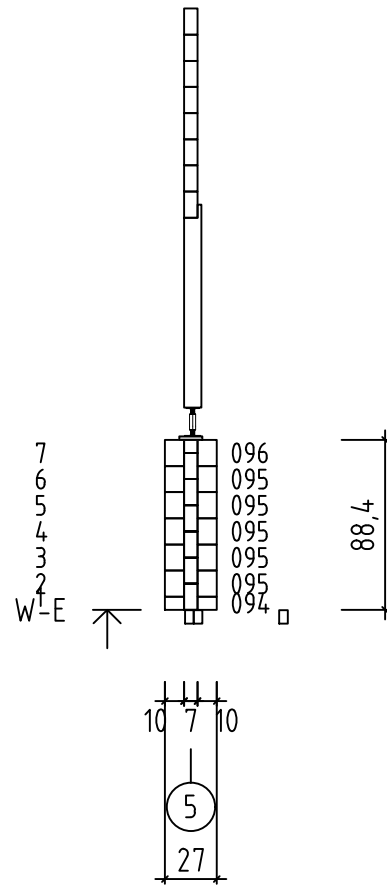



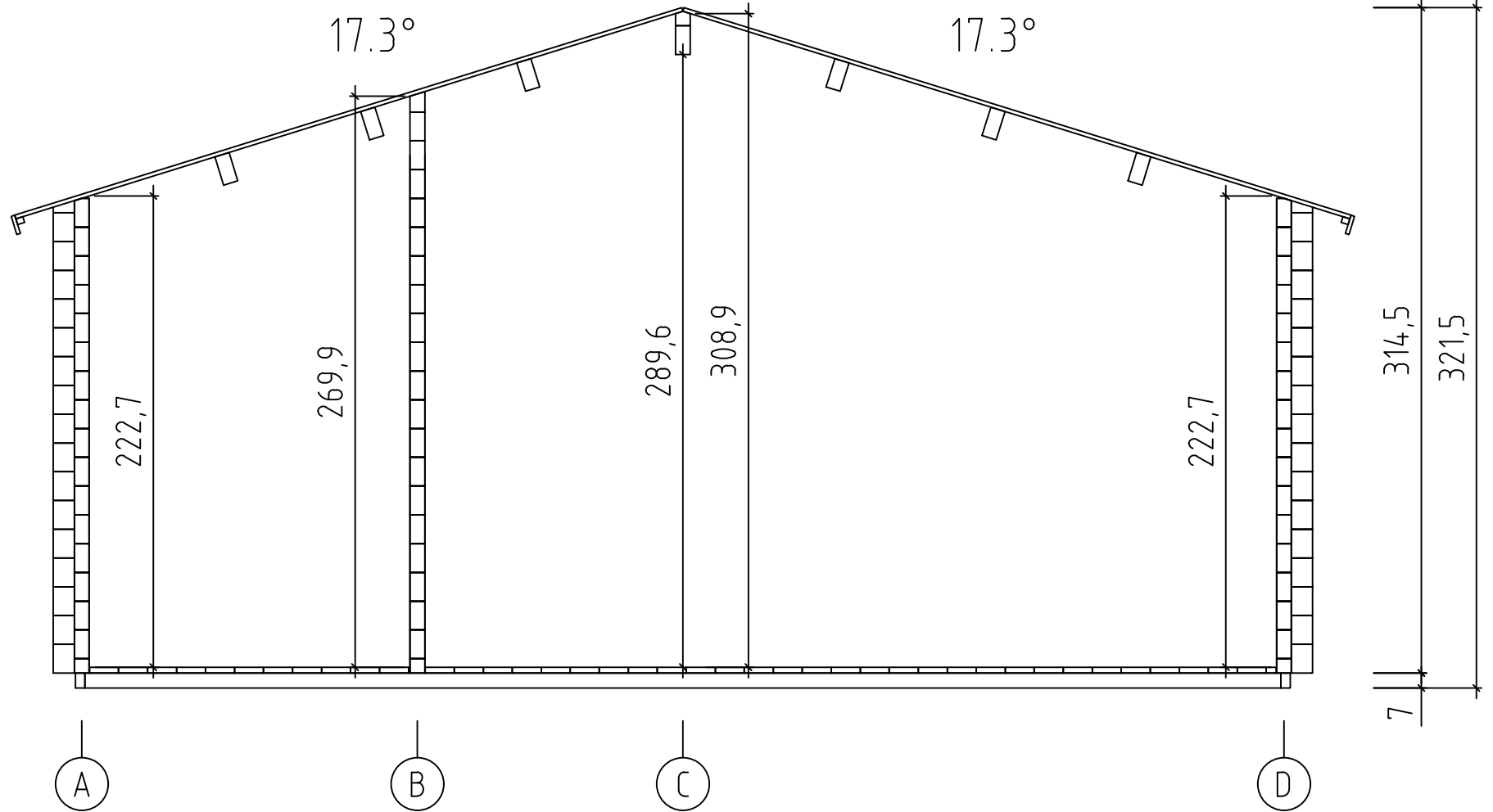

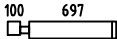
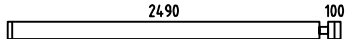
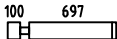
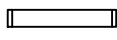
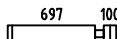
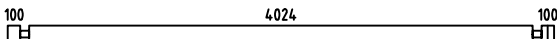
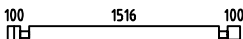
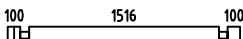
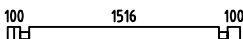
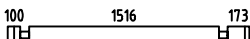
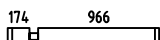
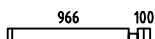
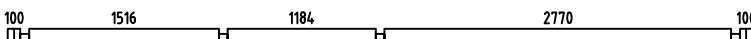
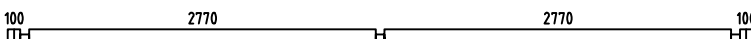
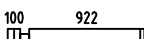
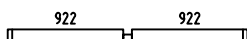
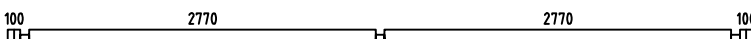
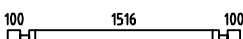

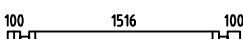
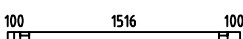



Kasai B 70, Art.Nr.7011741

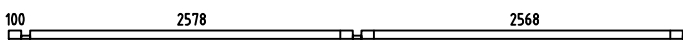
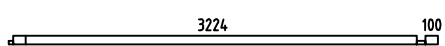
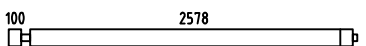
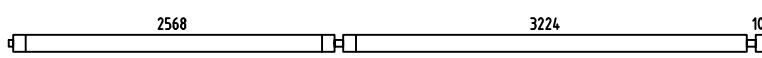

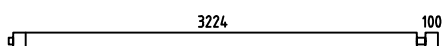
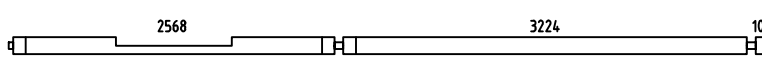
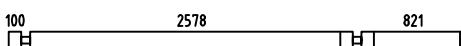
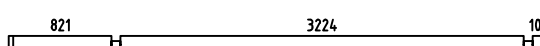
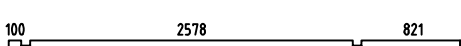
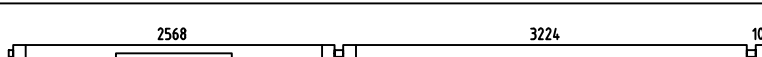

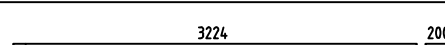
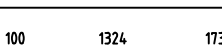

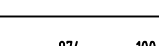
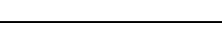

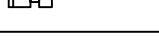
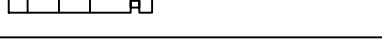
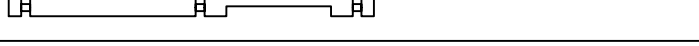
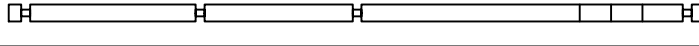
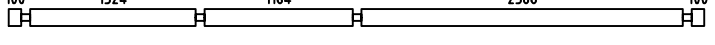
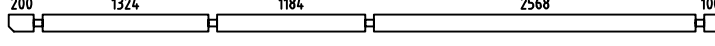
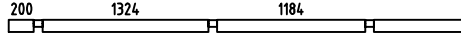
Kasai B 70, Art.Nr.7011741

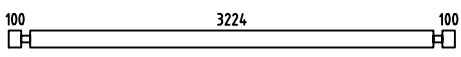
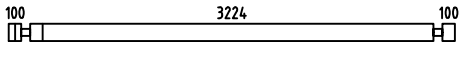
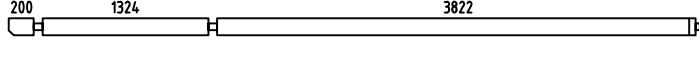
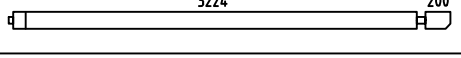
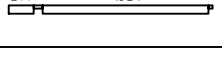
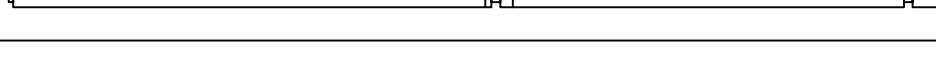
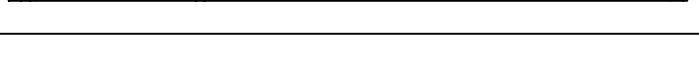
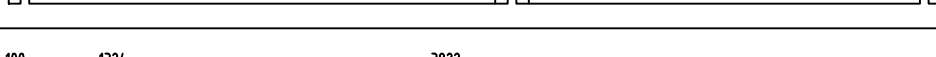
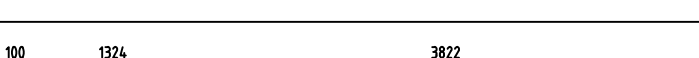
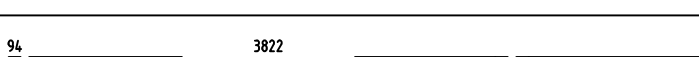
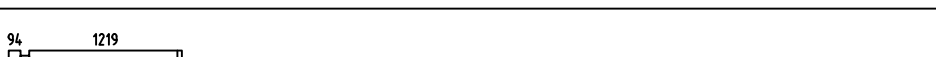
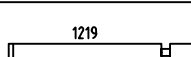
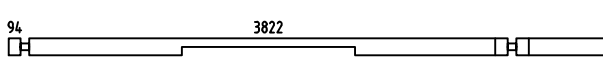
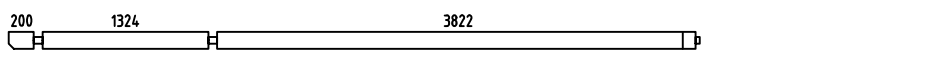
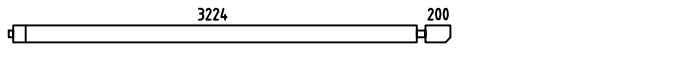





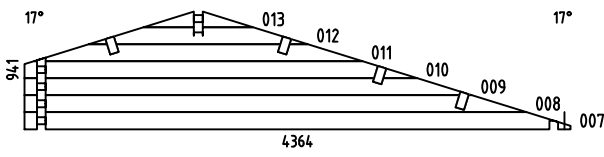
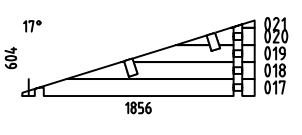

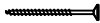
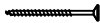
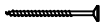

Pos	Kasai B 70, Art.Nr.7011741 Piece list - Stückliste - Liste des pieces	Q.	P (mm)	L (mm)
001		1	70x136	867
002		7	70x136	2660
003		14	70x136	867
004		8	70x136	867
005		8	70x136	867
006		1	70x136	4364
014		1	70x136	1856
015		21	70x136	1856
016		1	70x136	1856
022		15	70x136	1929
023		15	70x136	1210
024		15	70x136	1136
025		1	70x136	5950
032		7	70x136	5950
033		16	70x136	1092
034		8	70x136	1914
035		1	70x136	5950
041		1	70x136	1856
042		3	70x136	270
043		6	70x136	270
044		2	70x136	1856
045		1	70x68	1856
046		8	70x136	465
047		8	70x136	465
048		1	70x136	5950

Pos	Kasai B 70, Art.Nr.7011741 Piece list - Stückliste - Liste des pieces	Q.	P (mm)	L (mm)
053		1	70x68	5421
054		2	70x68	3429
055		5	70x136	2783
056		3	70x136	6067
057		3	70x136	5421
058		6	70x136	3429
059		1	70x136	6067
060		2	70x136	3639
061		7	70x136	4285
062		5	70x136	3639
063		1	70x136	6067
064		1	70x136	5521
065		1	70x136	3529
066		1	70x68	1738
067		1	70x68	343
068		1	70x68	1144
069		14	70x136	1738
070		14	70x136	343
071		15	70x136	1144
072		1	70x136	2918
073		1	70x136	5556
074		2	70x136	5556
075		1	70x136	5656
076		1	70x97	5656
077		1	70x68	3564

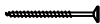
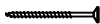
Pos	Kasai B 70, Art.Nr.7011741 Piece list - Stückliste - Liste des pieces	Q.	P (mm)	L (mm)
078		20	70x136	3564
079		1	70x136	3564
080		1	70x136	5521
081		1	70x136	3529
082		1	70x68	1629
083		1	70x68	7421
084		1	70x68	5421
085		3	70x136	7450
086		2	70x136	5421
087		1	70x136	5421
088		1	70x136	7450
089		7	70x136	1383
090		7	70x136	4683
091		1	70x136	7450
092		1	70x136	5521
093		1	70x136	3529
094		1	70x68	270
095		5	70x136	270
096		1	70x136	270
097		4	70x10	837
W1-1		1		
W2-1		1		

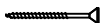
Pos	Kasai B 70, Art.Nr.7011741 Piece list - Stückliste - Liste des pieces	Q.	P (mm)	L (mm)
W3-1		1		
W4-1		1		
W5-1		1		
IAR4	FOUNDATION - FUNDAMENT - FONDATION 	21	45x70	5650
IAR1	FOUNDATION - FUNDAMENT - FONDATION 	2	45x70	4370
IAR2	FOUNDATION - FUNDAMENT - FONDATION 	2	45x70	4370
IAR6	FOUNDATION - FUNDAMENT - FONDATION 	2	45x70	4214
IAR5	FOUNDATION - FUNDAMENT - FONDATION 	2	45x70	1706
IAR3	FOUNDATION - FUNDAMENT - FONDATION 	2	45x70	537
A-PR3	ROOF BEAM - DACHBALKEN - PANNE DE TOIT 	4	70x140	5596
A-PR1	ROOF BEAM - DACHBALKEN - PANNE DE TOIT 	2	70x140	5596
A-PR2	ROOF BEAM - DACHBALKEN - PANNE DE TOIT 	6	70x140	3604
HLL	FLOOR BOARDS - FUSSBODENBRETTER - LAME DE PLANCHER 		137x28	339 m.
RB	ROOF BOARDS - DACHBRETTER - VOLIGES 	202	90x18	3300
SV2	TERRACE BOARDS - TERRASSENBRETTER - PLANCHER DE TERRASSE 	34	120x28	1320
FL	FLOOR FILLET-FUSSBODENLEISTE - CORNIERE DE FINITION DU PLANCHER 		15x40	51 m.
IT	TERRACE EDGE BOARD - TERRASSENBRETT, EINGANG - LAME DE SEUIL D'ENTREE DE TERRASSE 	1	28x70	2238
DPL	ROOFING FELT FILLET - DACHPAPPENLEISTE - BAGUETTE DE FIXATION DU FEUTRE BITUMEUX 	4	18x58	3350
M1	TREADED ROD M12 - GEWINDESTANGE M12 - TIGE FILETÉE M12 	7		250
M2	TREADED ROD M12 - GEWINDESTANGE M12 - TIGE FILETÉE M12 	7		2000
P	POST - PFOSTEN - POTEAU 	2	90x90	1055
TB	EAVES BOARD - TRAUFBRETT - BANDEAU DE TOIT 	4	18x90	4525

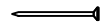
Pos	Kasai B 70, Art.Nr.7011741 Piece list - Stückliste - Liste des pieces	Q.	P (mm)	L (mm)
DRV	ROOF EDGE REINFORCEMENT - DACHRANDVERSTÄRKUNG - CORNIERE DE RENFORT DE BORD DE TOIT 	4	28x34	4525
TBE6-1	FIXING FILLET FOR WINDOW - FIXIRUNGSLEISTE FÜR FENSTER - PROFIL DE FIXATION DES FENETRES 	4	28x34	884
TBE6-2	FIXING FILLET FOR WINDOW - FIXIRUNGSLEISTE FÜR FENSTER - PROFIL DE FIXATION DES FENETRES 	8	28x34	1050
TBE6-3	FIXING FILLET FOR DOOR - FIXIRUNGSLEISTE FÜR TÜR - PROFIL DE FIXATION DES PORTES 	2	28x34	1894
TBE6-4	FIXING FILLET FOR DOOR - FIXIRUNGSLEISTE FÜR TÜR - PROFIL DE FIXATION DES PORTES 	6	28x34	1990
TG1	GUARD-RAIL FOR TERRACE - TERRASSEN GELÄNDER - MAIN COURANTE DE TERRASSE 	1	18x120	1325
TG2	GUARD-RAIL FOR TERRACE - TERRASSEN GELÄNDER - MAIN COURANTE DE TERRASSE 	1	18x120	1783
GL	GABLE MOULDING - GIEBELLEISTE - PLANCHE DE RIVE 	4	18x120	3350
SP1	HIDDEN FIXING - HOLZDÜBEL - TOURILLON BOIS 	6		190
SP2	HIDDEN FIXING - HOLZDÜBEL - TOURILLON BOIS 	60		260
KL4	LENGTHENING BOLT FOR TREADED ROD - VERLÄNGERUNGSMUTTER FÜR GEWINDESTANGE - MANCHON DE RACCORDEMENT DE TIGE FILETÉE 	7		
KL1	DRIVE NUT TREADED ROD - EINSHLAGMUTTER FÜR GEWINDESTANGE - ÉCROU A FRAPPER POUR TIGE FILITÉE 	7		
KL2	NUT FOR TREADED ROD - MUTTER FÜR GEWINDESTANGE - ÉCROU POUR TIGE FILETÉE 	7		
KL3	PLAIN WASHER TREADED ROD - UNTERLEGSCHIEBE FÜR GEWINDESTANGE - RONDELLE PLATE POUR TIGE FILETÉE 	7		
HS12	SCREW FOR GABLE SEGMENT - SCHRAUBEN FÜR DECKBLATT - VIS POUR FIXATION LOSANGE DE FINITION 	4	3.5x35	
HS84	SCREW FOR FIXING FILLET - SCHRAUBEN FÜR FIXIRUNGSLEISTE - VIS POUR PROFIL DE FIXATION 	88	3.5x50	
HS16	SCREW FOR GABLE MOULDING - SCHRAUBEN FÜR GIEBELLEISTE - VIS DE FIXATION POUR PLANCHE DE RIVE 	40	3.5x50	
HS25	SCREW FOR FLOOR BOARDS - SCHRAUBEN FÜR FUSSBODENBRETT - VIS D'ASSEMBLAGE DES LAMES DE PLANCHER 	722	3.9x70	
NFD	SCREW FOR ROOFING FELT FILLET - SCHRAUBEN FÜR DACHPAPPENLEISTE - VIS POUR BAGUETTE FIXATION FEUTRE BITUMEUX 	32	4x40	
HS32	SCREW FOR EAVES BOARDS - SCHRAUBEN FÜR TRAUFBRETT - VIS DE FIXATION POUR BANDEAU DE TOIT 	40	4x40	
HS26	SCREW FOR ROOF EDGE REINFORCEMENT - SCHRAUBEN FÜR DACHRANDVERSTÄRKUNG - VIS POUR RENFORT DE BORD DE TOIT 	40	4x40	
HS30	SCREW FOR TERRACE REAR BOARDS - SCHRAUBEN FÜR TERRASSENRAND - VIS DE FIXATION POUR MAIN COURANTE DE TERRASSE 	9	4x40	
HS46	SCREW FOR FUNDAMENT - SCHRAUBEN ZUR BEFESTIGUNG FUNDAMENT - VIS POUR FONDATION 	4	4x60	
HS34	SCREW FOR POST - SCHRAUBEN FÜR PFOSTEN - VIS DE FIXATION DES POTEAUX 	4	4x60	
HS40	SCREW FOR 1. WALL BEAM - SCHRAUBE FÜR 1. BOHLENREIHE - VIS DE FIXATION DES FONDATIONS 	26	5x120	

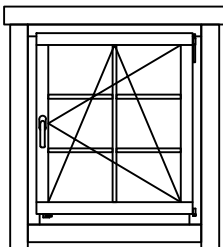
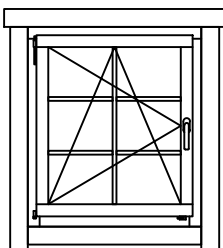
Pos	Kasai B 70, Art.Nr.7011741 Piece list - Stückliste - Liste des pieces	Q.	P (mm)	L (mm)
HS78	SCREW FOR POS. 082-083 - SCHRAUBEN FÜR POS. 082-083 - VIS POUR POS. 082-083 	12	5x120	
HS42	SCREW FOR GABLE - SCHRAUBEN FÜR GIEBEL - VIS POUR FIXATION DES PIGNONS 	49	5x120	
HS43	SCREW FOR ROOF BEAMS - SCHRAUBEN FÜR DACHBALKEN - VIS POUR PANNE DE TOIT 	12	5x120	
HS39	SCREW FOR FUNDAMENT - SCHRAUBEN ZUR BEFESTIGUNG FUNDAMENT - VIS POUR FONDATION 	84	5x90	
HS65	SCREW FOR ROOF BEAMS - SCHRAUBEN FÜR DACHBALKEN - VIS POUR PANNE DE TOIT 	24	6x180	
HS49	SCREW FOR POST HEIGHT ADJUSTMENT - SCHRAUBEN FÜR REGULIERUNGSSCHRAUBE FÜR PFOSTEN - VIS DE FIXATION DE SUPPORT RÉGLABLE DE POTEAU 	16	6x50	
MS	SCREW FOR DOORSTEP - SCHRAUBEN FÜR TÜRSCHWELLE - VIS DE FIXATION DU SEUIL DE PORTE 	8	4.5x65	
NF3	SCREW FOR TERRACE BOARD - SCHRAUBEN FÜR TERRASSENBRETT - VIS POUR LAME DE SEUIL D'ENTREE DE TERRASSE 	274	4.2x55	
SH70	HAMMER BLOCK - SCHLAGHOLZ - CALLE DE FRAPPE 	2		
NFF	ZN NAIL FOR FLOOR FILLETS - ZN NÄGEL FÜR FUSSBODENLEISTEN - POINTE POUR PANNEAUX DE PLANCHER 	106	1.4x40	
NF2	ZN NAIL FOR ROOF - ZN NÄGEL FÜR DACHBRETT - POINTE POUR TOIT 	1070	2.1x50	
ORZ	MONTAGE SET FOR DOORS AND WINDOWS - MONTAGE-SET FÜR TÜREN UND FENSTER - JEU DE MONTAGE PORTES ET FENETRES	1		
GS	GABLE SEGMENT-DECKBLATT - LOSANGE DE FINITION 	2		
RFP	POST HEIGHT ADJUSTMENT - REGULIERUNGSSCHRAUBE FÜR PFOSTEN - SUPPORT RÉGLABLE DE POTEAU 	2		
	WINDOW-FENSTER-FENETRE 916x1050 2+ A.6P.a 	4		
	WINDOW-FENSTER-FENETRE 916x1050 2+ A.6V.a 	1		

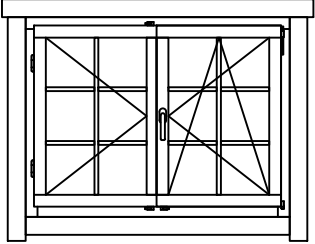
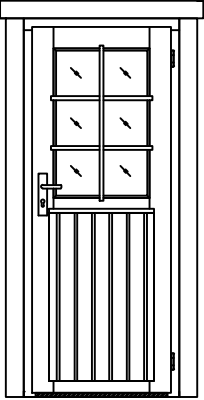
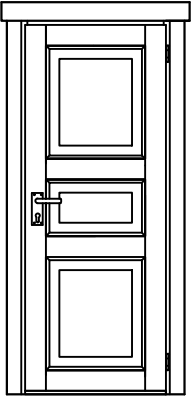
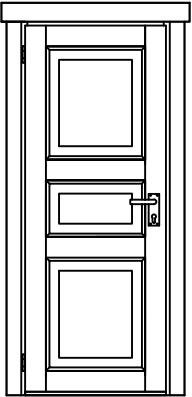
Pos	Kasai B 70, Art.Nr.7011741 Piece list - Stückliste - Liste des pieces	Q.	P (mm)	L (mm)
	<p data-bbox="603 141 919 203">WINDOW-FENSTER-FENETRE 1374x1050 2+ TA.6P.a</p> 	1		
	<p data-bbox="643 557 879 620">DOOR-TÜR-PORTE 827x2000 2+ U.26V.b</p> 	1		
	<p data-bbox="655 1140 866 1202">DOOR-TÜR-PORTE 827x2000 U.3TP.b</p> 	1		
	<p data-bbox="655 1639 866 1702">DOOR-TÜR-PORTE 827x2000 U.3TV.b</p> 	2		

