

Barbados 3 70mm
Art.No. 7011602

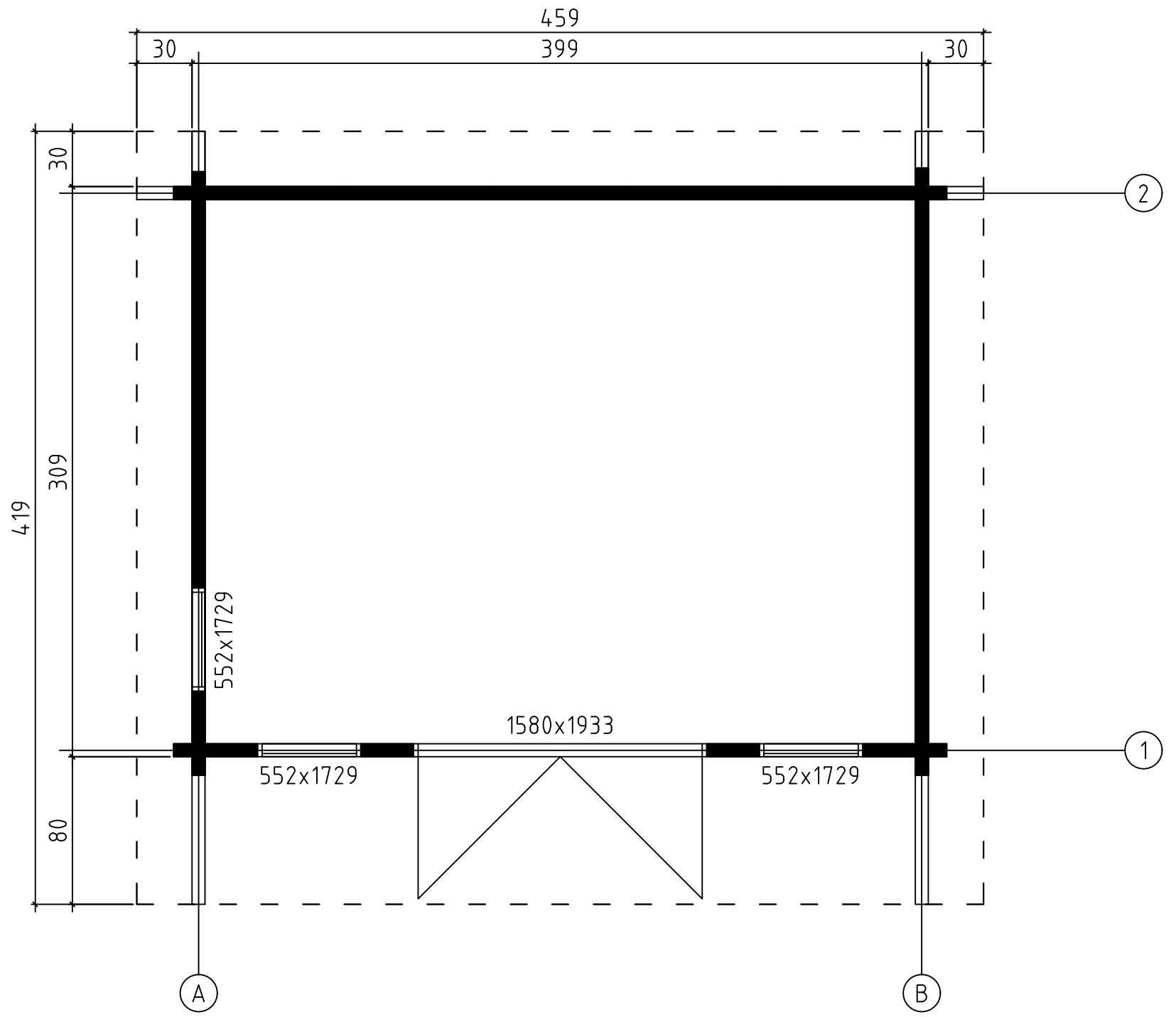

Barbados 3 70mm, Art.No. 7011602
GROUNDPLAN - GRUNDPLAN - PLAN DE MASSE



FOUNDATION - FUNDAMENT - FONDATION

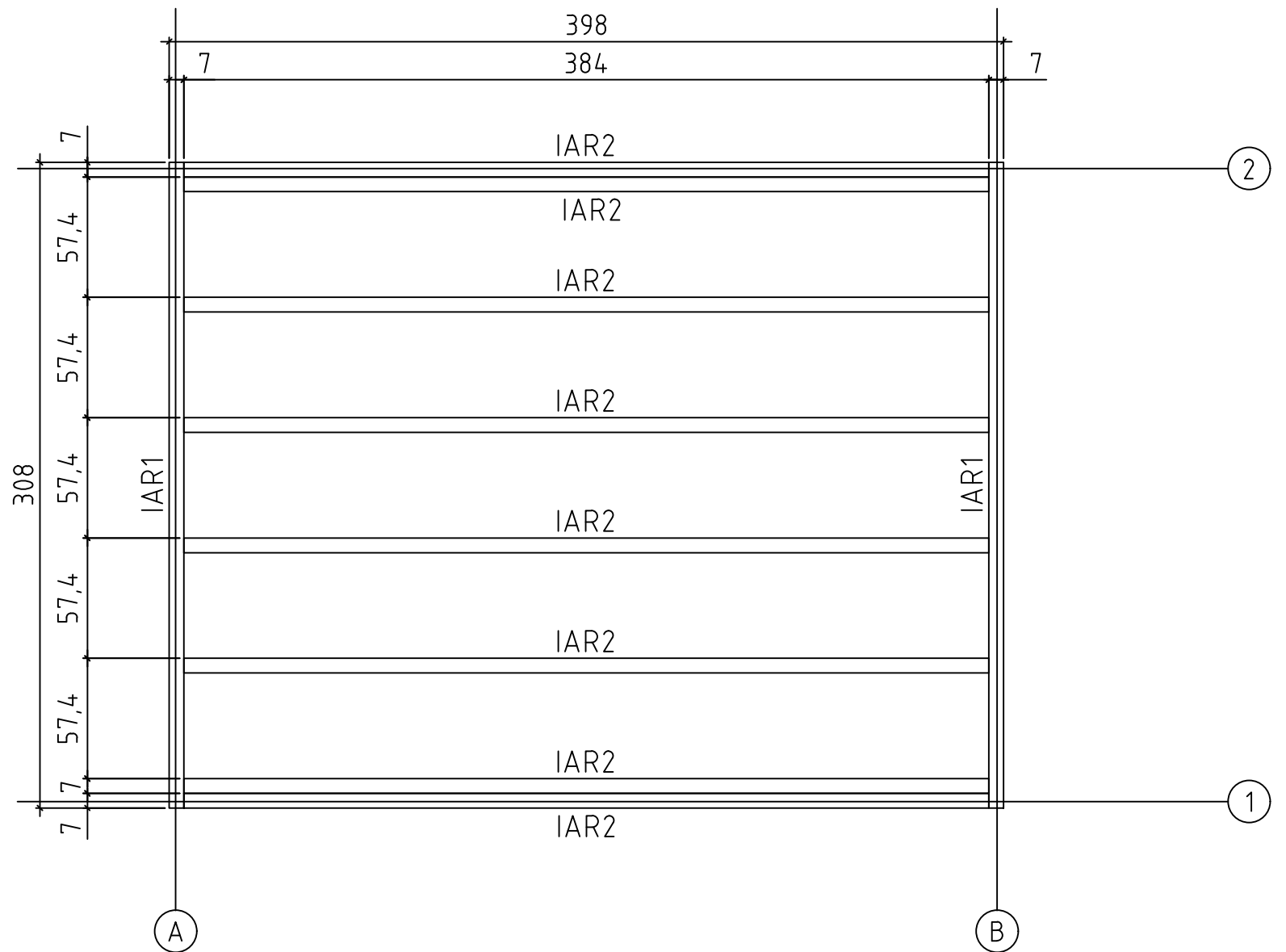

Barbados 3 70mm, Art.No. 7011602
RAFTERS PLAN - DACHSPARREN - PLAN DE CHEVRON

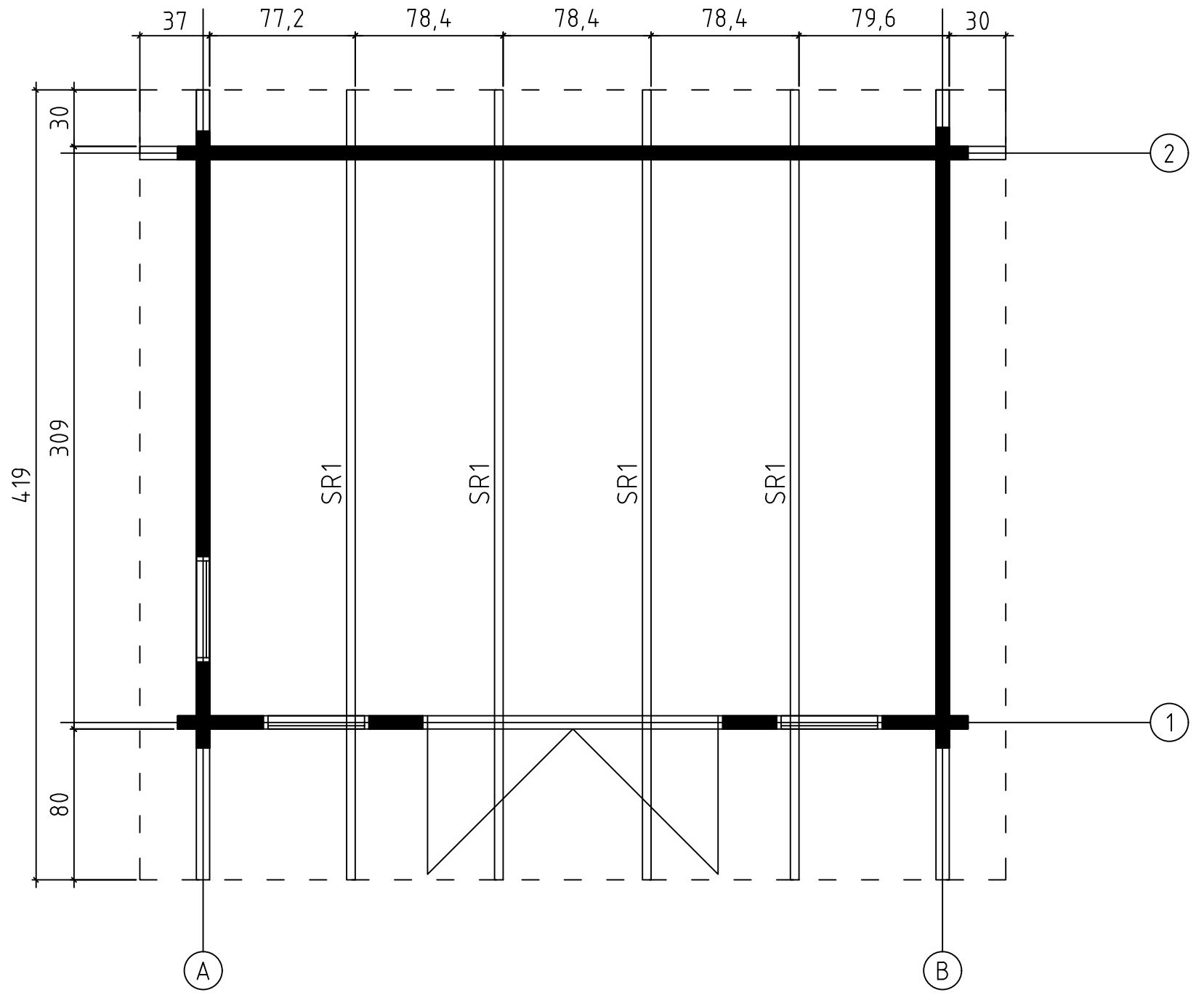



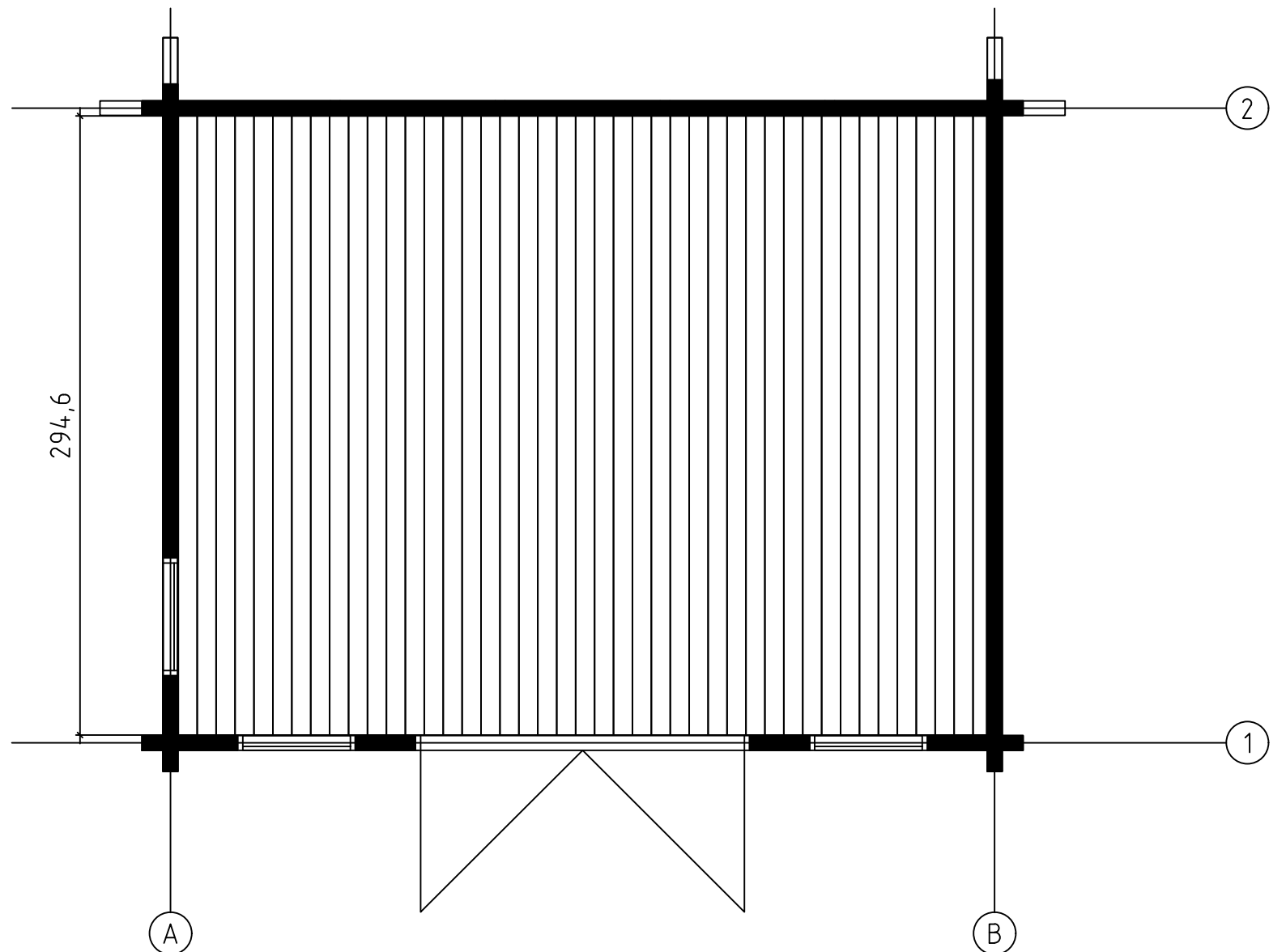

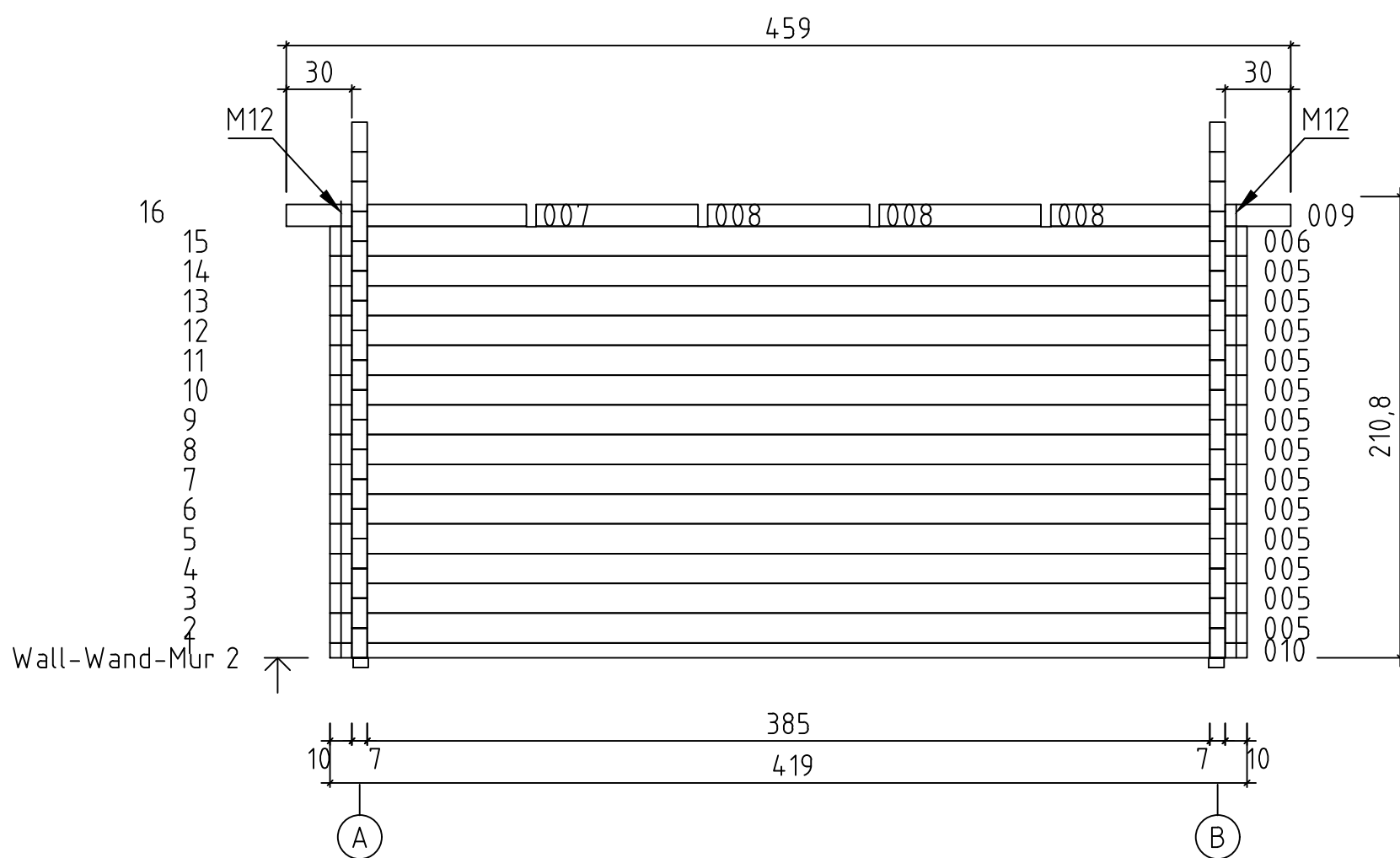
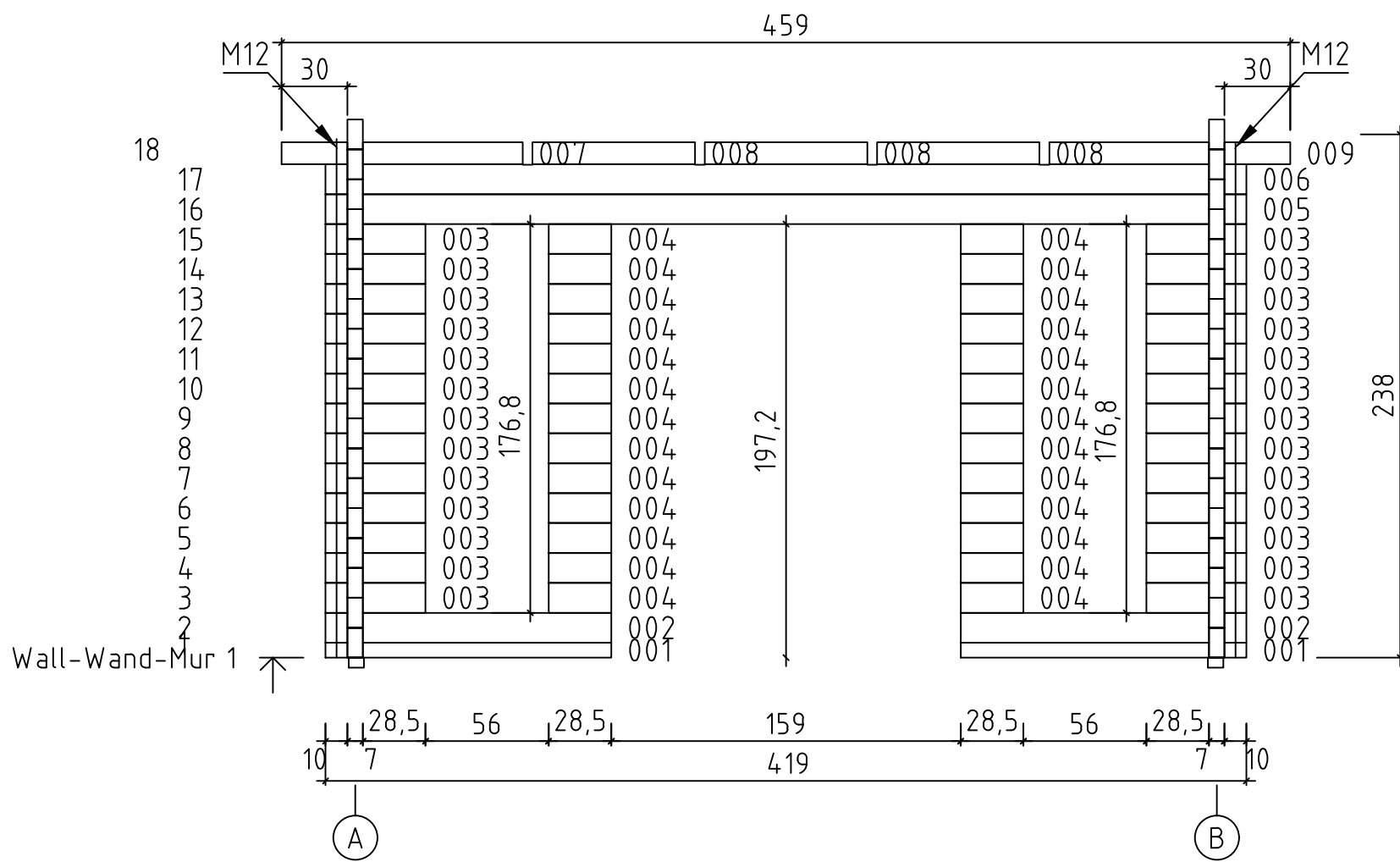
FLOOR BOARDS - FUSSBODENBRETTER - PLAN POSE PLANCHER

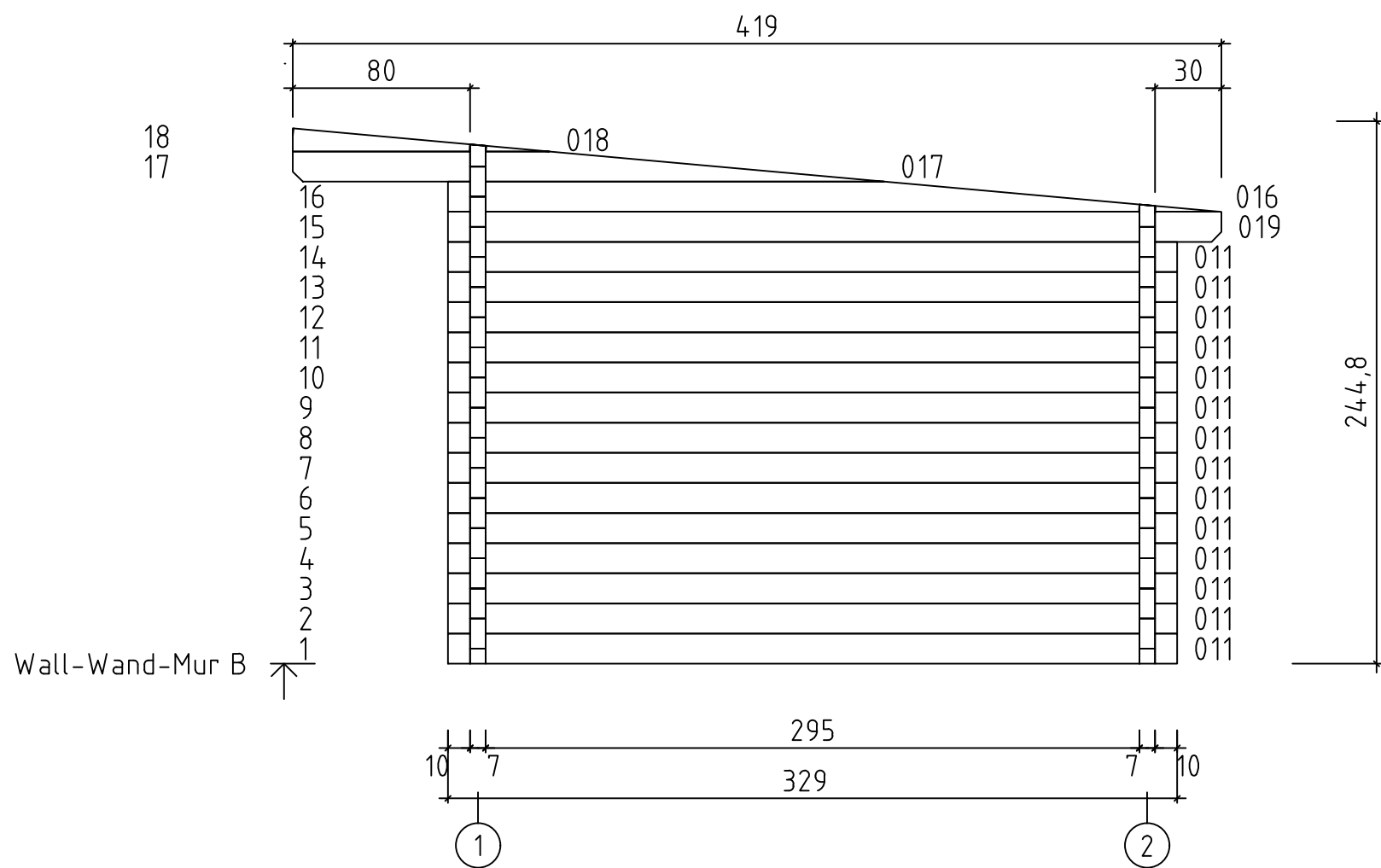
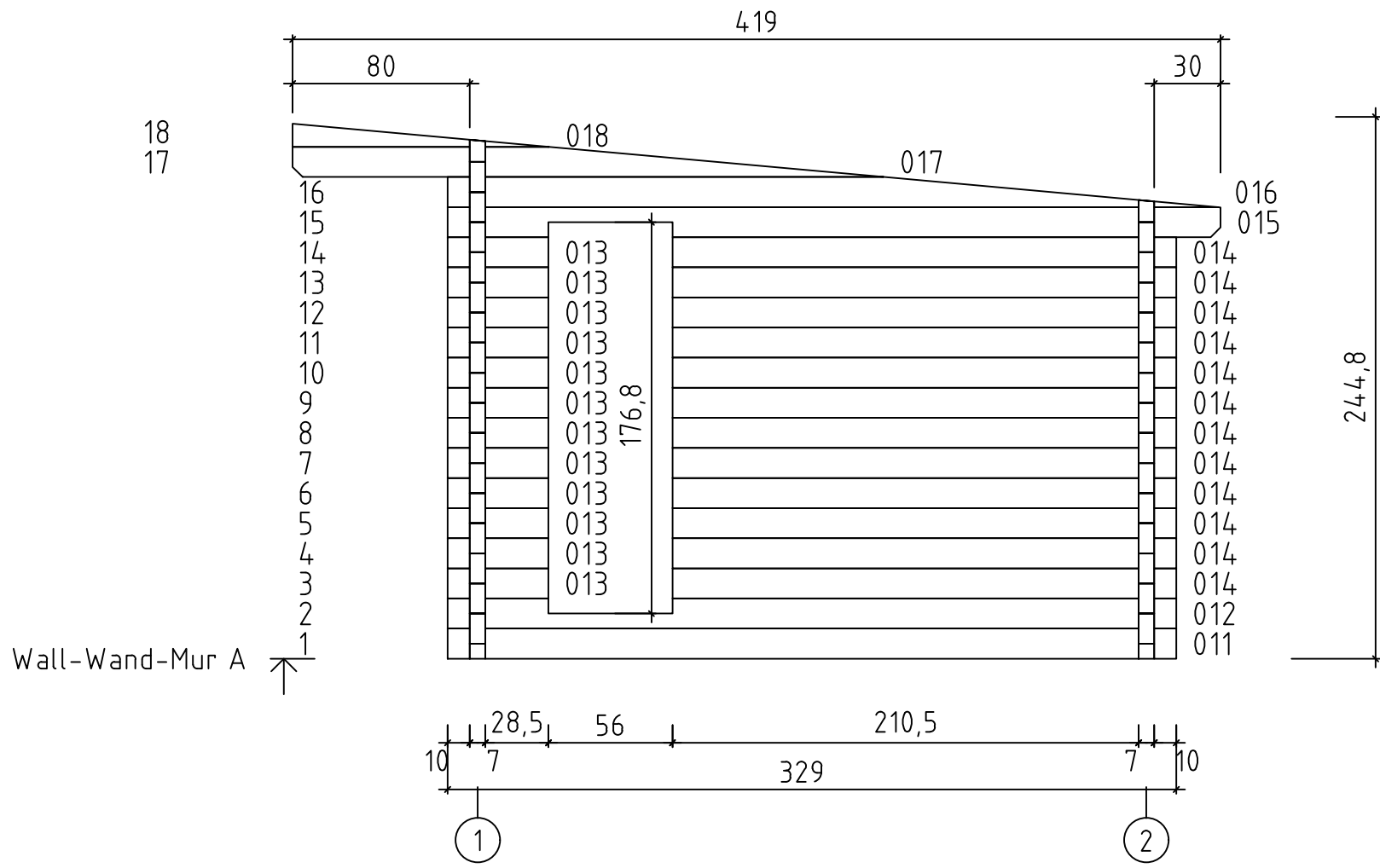

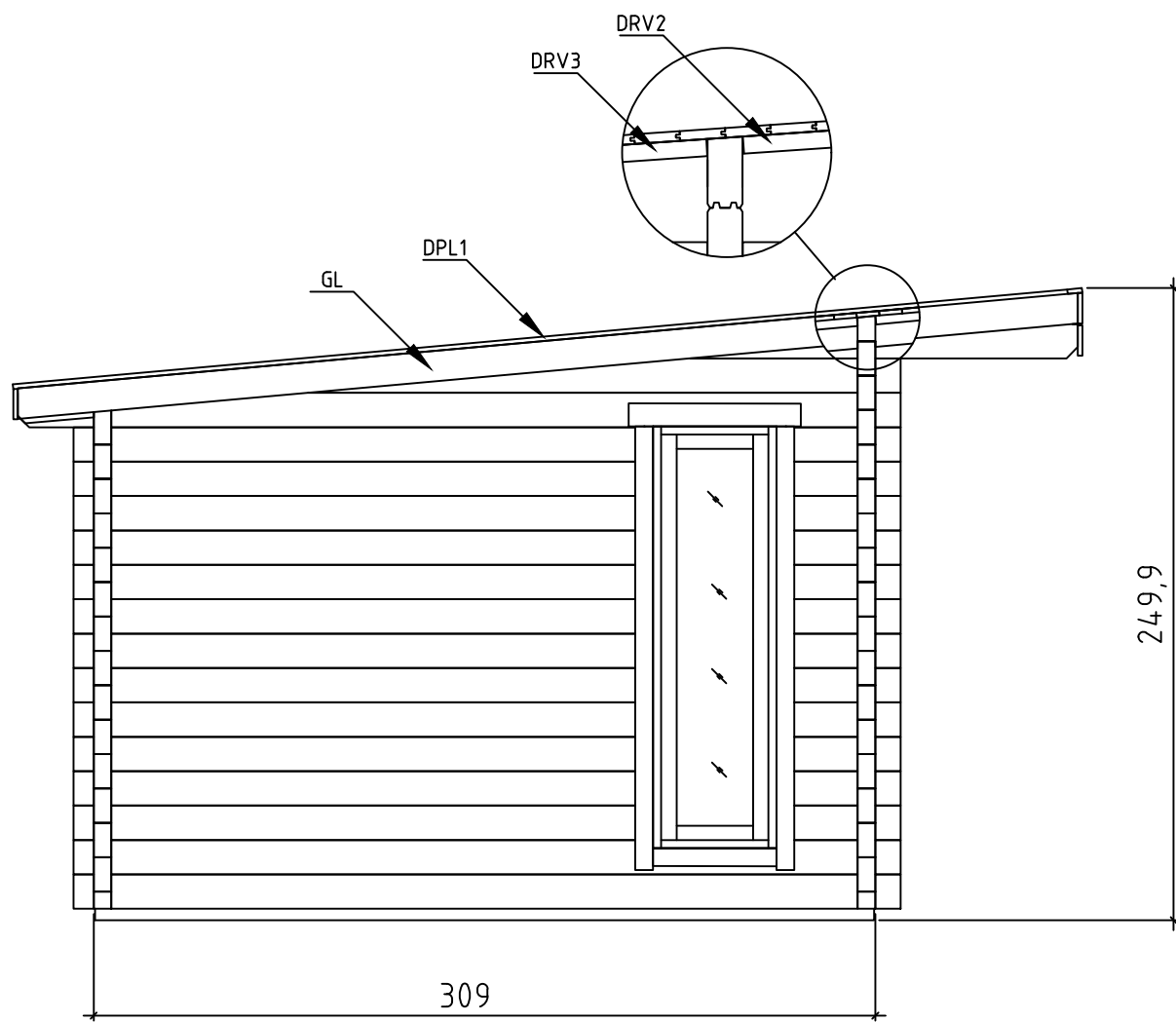
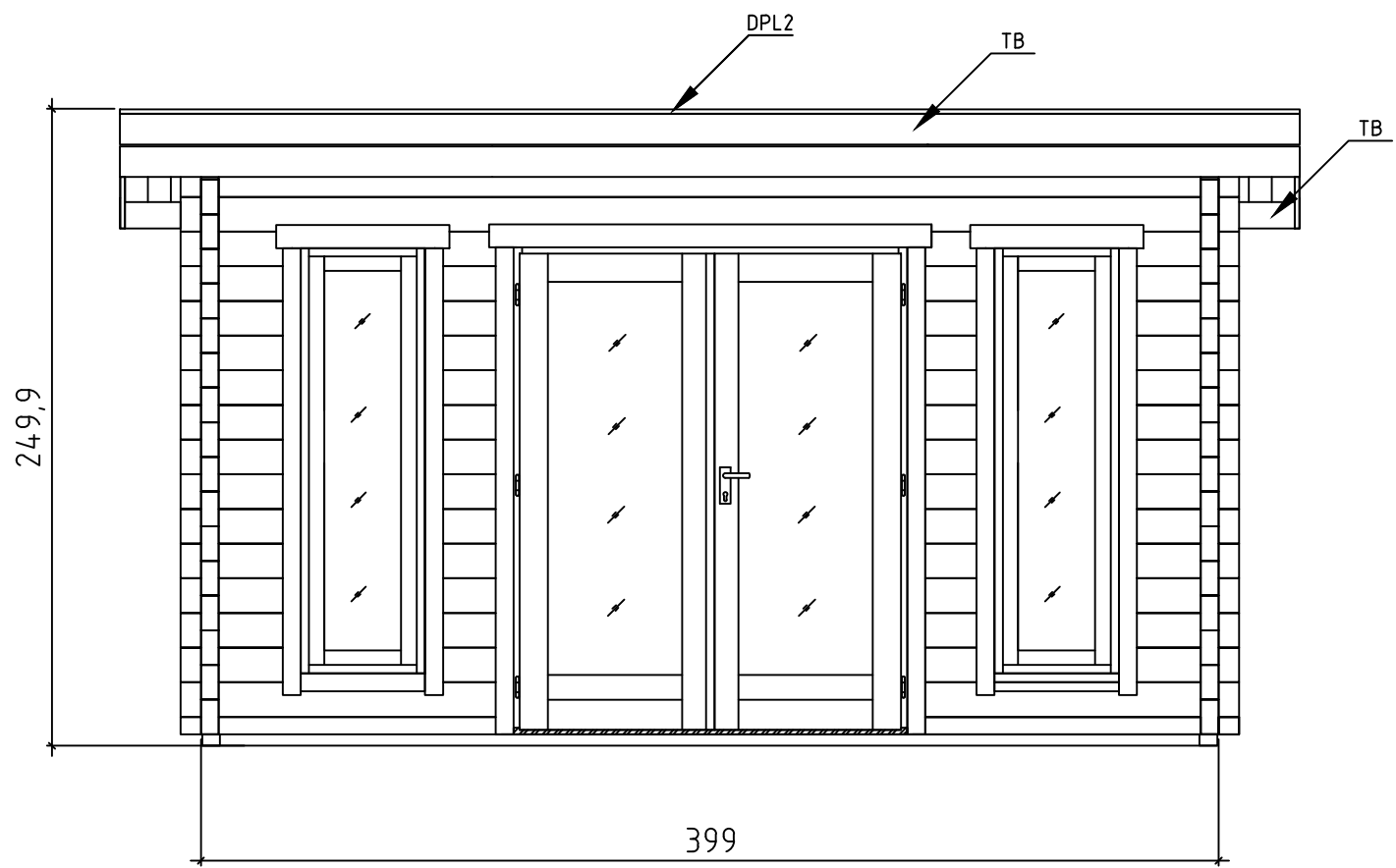

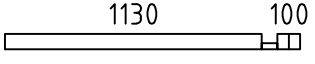
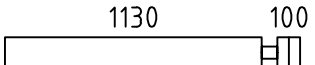
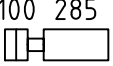

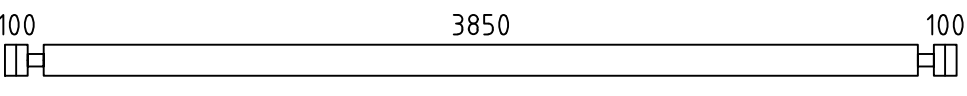
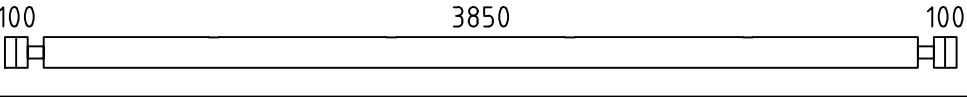
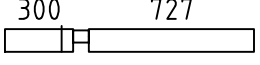
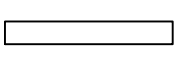
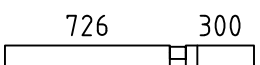
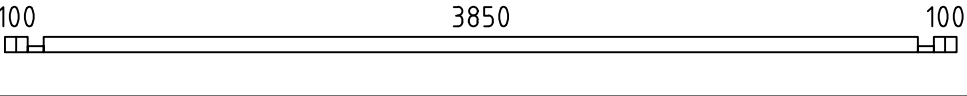
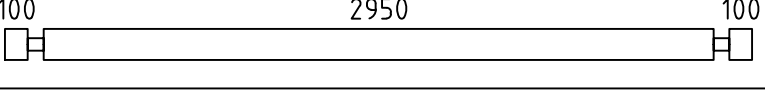
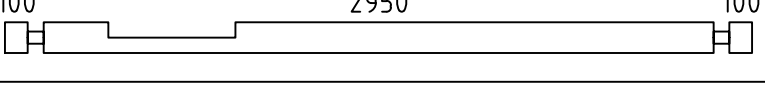
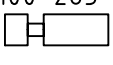
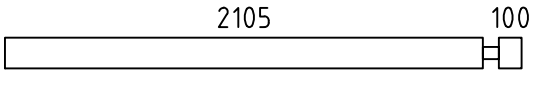
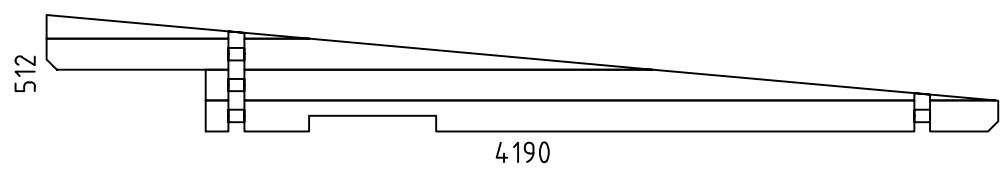
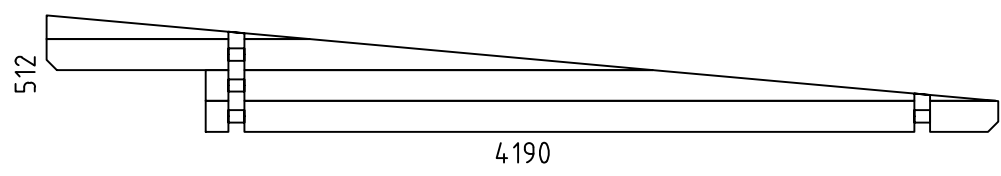
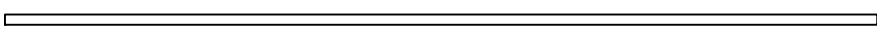
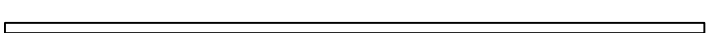
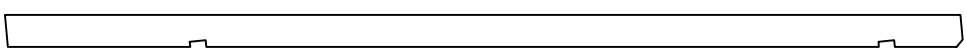
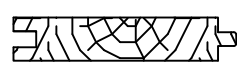
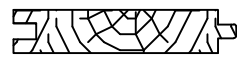

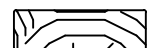

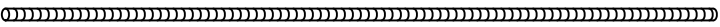

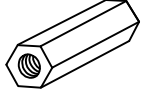
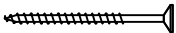
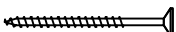

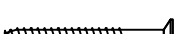

Pos	Barbados 3 70mm, Art.No. 7011602 Piece list - Stückliste - Liste des pieces	Q.	P (mm)	L (mm)
001		2	70x68	1300
002		2	70x136	1300
003		26	70x136	455
004		26	70x136	285
005		14	70x136	4190
006		2	70x136	4190
007		2	70x100	1097
008		6	70x100	739
009		2	70x100	1096
010		1	70x68	4190
011		15	70x136	3290
012		1	70x136	3290
013		12	70x136	455
014		12	70x136	2275
WA-1		1		
WB-1		1		
IAR2	FOUNDATION - FUNDAMENT - FONDATION 	8	70x45	3840
IAR1	FOUNDATION - FUNDAMENT - FONDATION 	2	70x45	3080
SR1	RAFTER - DACHSPARREN - CHEVRON 	4	45x140	4220
	FLOOR BOARDS - FUSSBODENBRETTER - LAME DE PLANCHER 	43	90x18	2946
	ROOF BOARDS - DACHBRETTER - VOLIGES 	47	90x18	4590
	FLOOR FILLET-FUSSBODENLEISTE - CORNIERE DE FINITION DU PLANCHER 		18x18	13.6 m.
DPL1	ROOFING FELT FILLET - DACHPAPPENLEISTE - BAGUETTE DE FIXATION DU FEUTRE BITUMEUX 	2	18x58	4185

Pos	Barbados 3 70mm, Art.No. 7011602 Piece list - Stückliste - Liste des pieces		Q.	P (mm)	L (mm)
DPL2	ROOFING FELT FILLET - DACHPAPPENLEISTE - BAGUETTE DE FIXATION DU FEUTRE BITUMEUX		1	18x58	4628
M12	TREADED ROD M12 - GEWINDESTANGE M12 - TIGE FILETÉE M12		2		100
M12	TREADED ROD M12 - GEWINDESTANGE M12 - TIGE FILETÉE M12		2		375
M12	TREADED ROD M12 - GEWINDESTANGE M12 TIGE FILETÉE M12		4		2000
TB	EAVES BOARD - TRAUFBRETT - BANDEAU DE TOIT		3	18x120	4628
DRV1	ROOF EDGE REINFORCEMENT - DACHRANDVERSTÄRKUNG - CORNIERE DE RENFORT DE BORD DE TOIT		2	28x34	297
DRV2	ROOF EDGE REINFORCEMENT - DACHRANDVERSTÄRKUNG - CORNIERE DE RENFORT DE BORD DE TOIT		2	28x34	798
DRV3	ROOF EDGE REINFORCEMENT - DACHRANDVERSTÄRKUNG - CORNIERE DE RENFORT DE BORD DE TOIT		2	28x34	2958
GL	GABLE MOULDING - GIEBELLEISTE PLANCHE DE RIVE		2	18x120	4218
KL4	LENGTHENING BOLT FOR TREADED ROD - VERLÄNGERUNGSMUTTER FÜR GEWINDESTANGE - MANCHON DE RACCORDEMENT DE TIGE FILETÉE		4		
KL1	DRIVE NUT TREADED ROD - EINSHLAGMUTTER FÜR GEWINDESTANGE - ÉCROU A FRAPPER POUR TIGE FILETÉE		4		
KL2	NUT FOR TREADED ROD - MUTTER FÜR GEWINDESTANGE - ÉCROU POUR TIGE FILETÉE		4		
KL3	PLAIN WASHER TREADED ROD - UNTERLEGSCHLEIBE FÜR GEWINDESTANGE - RONDELLE PLATE POUR TIGE FILETÉE		4		
HS32	SCREW FOR EAVES BOARDS - SCHRAUBEN FÜR TRAUFBRETT VIS DE FIXATION POUR BANDEAU DE TOIT		37	3.5x50	
HS16	SCREW FOR GABLE MOULDING - SCHRAUBEN FÜR GIEBELLEISTE VIS DE FIXATION POUR PLANCHE DE RIVE		22	3.5x50	
NFD	SCREW FOR ROOFING FELT FILLET - SCHRAUBEN FÜR DACHPAPPENLEISTE - VIS POUR BAGUETTE FIXATION FEUTRE BITUMEUX		28	4x40	
HS26	SCREW FOR ROOF EDGE REINFORCEMENT - SCHRAUBEN FÜR DACHRANDVERSTÄRKUNG - VIS POUR RENFORT DE BORD DE TOIT		24	4x40	
HS40	SCREW FOR 1. WALL BEAM - SCHRAUBE FÜR 1. BOHLENREIHE VIS DE FIXATION DES FONDATIONS		7	5x120	
HS39	SCREW FOR FUNDAMENT - SCHRAUBEN ZUR BEFESTIGUNG FUNDAMENT - VIS POUR FONDATION		24	5x120	
HS42	SCREW FOR GABLE - SCHRAUBEN FÜR GIEBEL - VIS POUR FIXATION DES PIGNONS		6	5x120	
HS48	SCREW FOR Pos.007-009 - SCHRAUBEN FÜR Pos.007-009 VIS POUR Pos.007-009		20	6x180	
HS44	SCREW FOR RAFTER - SCHRAUBEN ZUR BEFESTIGUNG DACHSPARREN - VIS POUR CHEVRON		8	6x180	
MS	SCREW FOR DOORSTEP - SCHRAUBEN FÜR TÜRSCHWELLE - VIS DE FIXATION DU SEUIL DE PORTE		3	4.5x65	
SH70	HAMMER BLOCK - SCHLAGHOLZ - CALLE DE FRAPPE		1		
NFF	ZN NAIL FOR FILLETS - ZN NÄGEL FÜR LEISTEN - POINTE POUR CORNIERE		27	1.4x40	

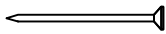
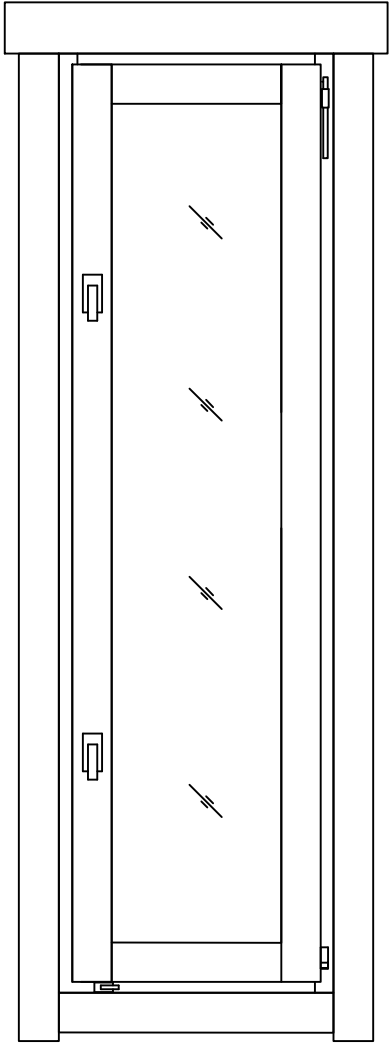
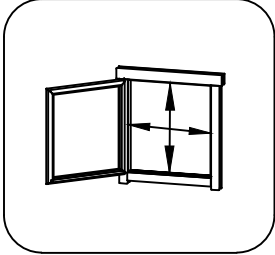
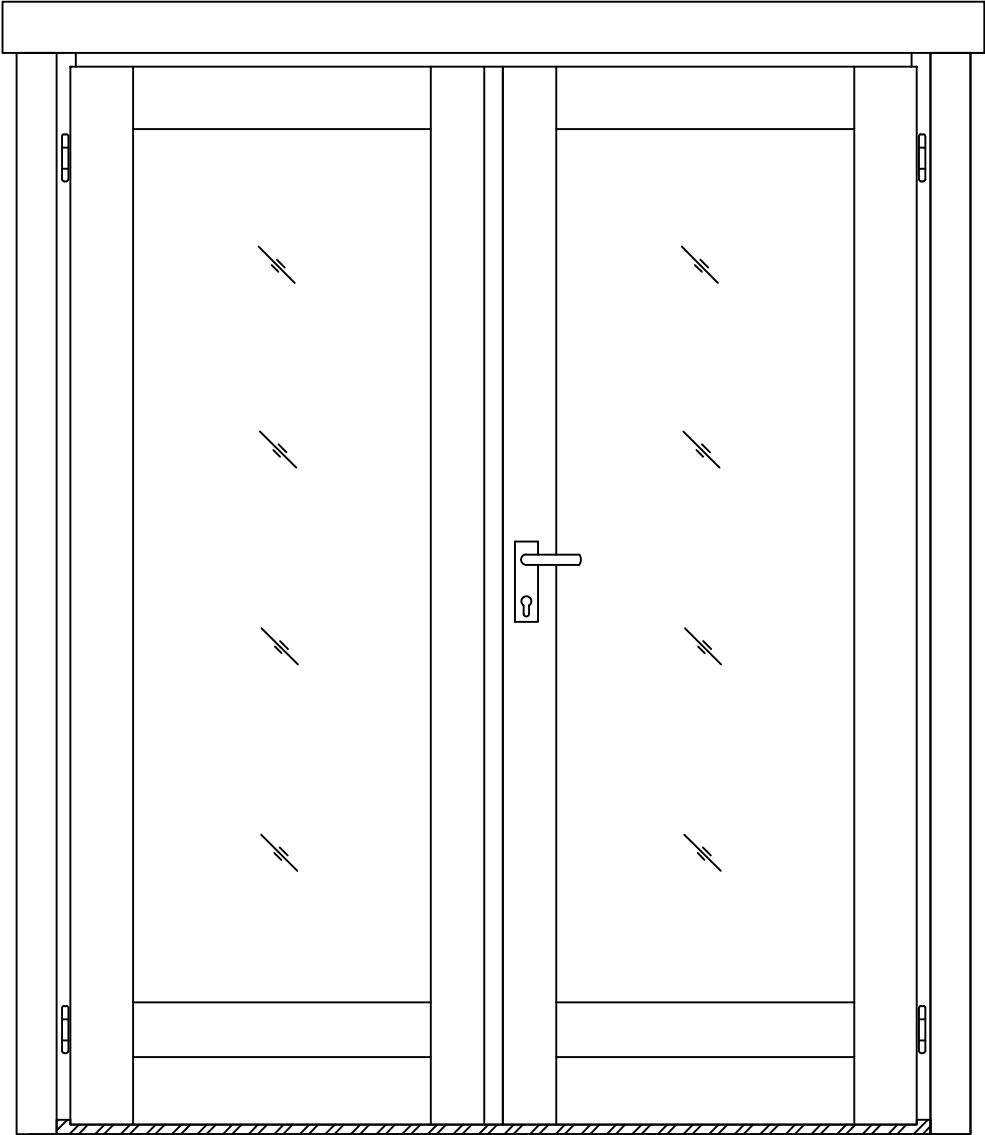
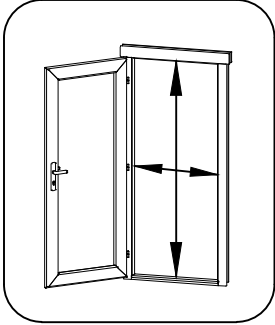
Pos	Barbados 3 70mm, Art.No. 7011602 Piece list - Stückliste - Liste des pieces	Q.	P (mm)	L (mm)
NF2	ZN NAIL FOR ROOF - ZN NÄGEL FÜR DACHBRETTER - POINTE POUR TOIT 	305	2x50	
NH1	ZN NAIL FOR FLOOR - ZN NÄGEL FÜR FUSSBODENBRETTER - CLOUS POUR PLANCHER 	350	2x50	
ORZ	MONTAGE SET FOR DOORS AND WINDOWS - MONTAGE-SET FÜR TÜREN UND FENSTER - JEU DE MONTAGE PORTES ET FENETRES	1		
2+ A.0P.b	WINDOW-FENSTER-FENETRE 552x1729   <p data-bbox="1415 804 1591 834">432x1587 mm</p>	3		
2+ TU.10P	DOOR-TÜR-PORTE 1580x1933   <p data-bbox="1415 2039 1598 2068">1460x1846 mm</p>	1		

