

*Han 70*  
Art.No. 7010441

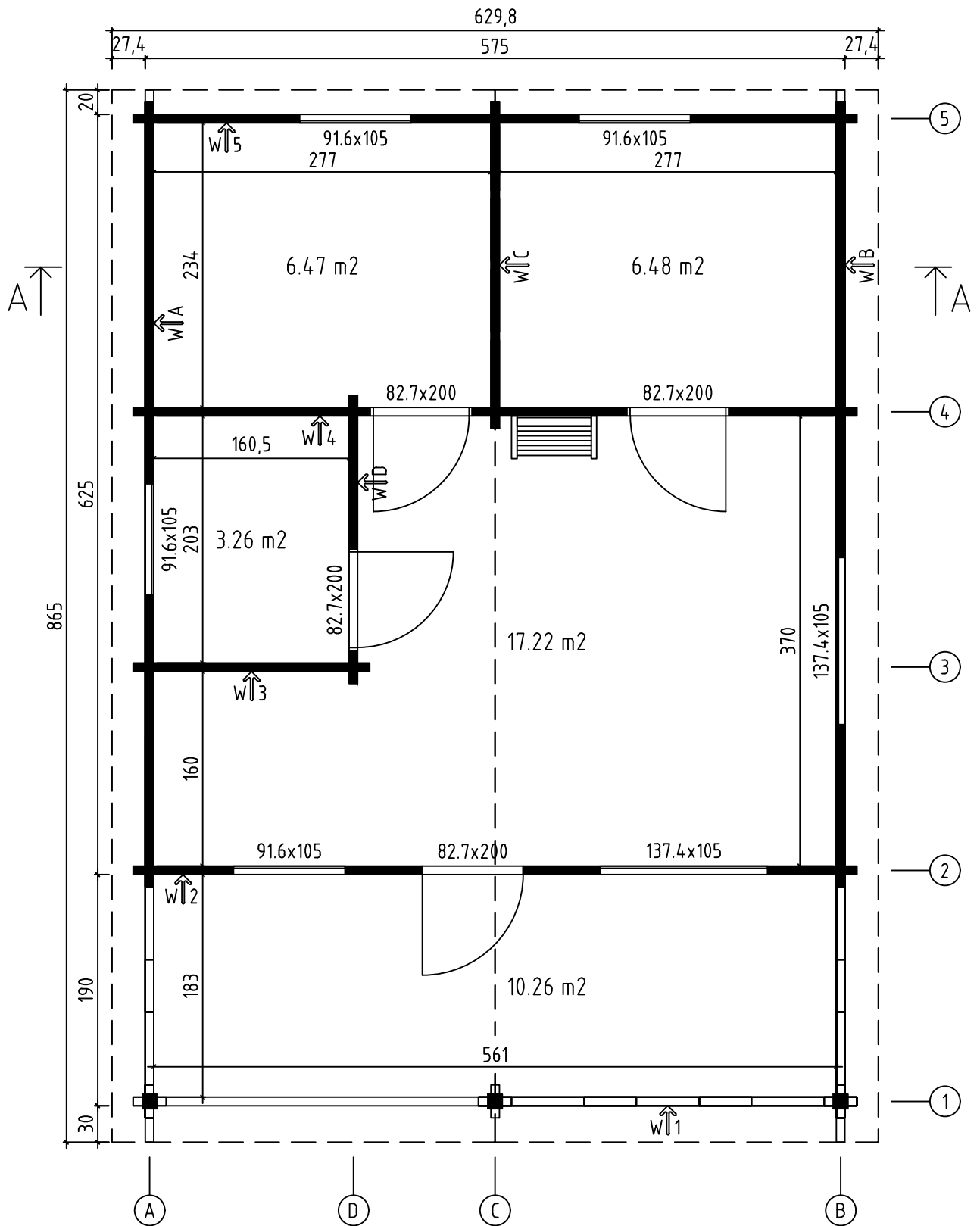

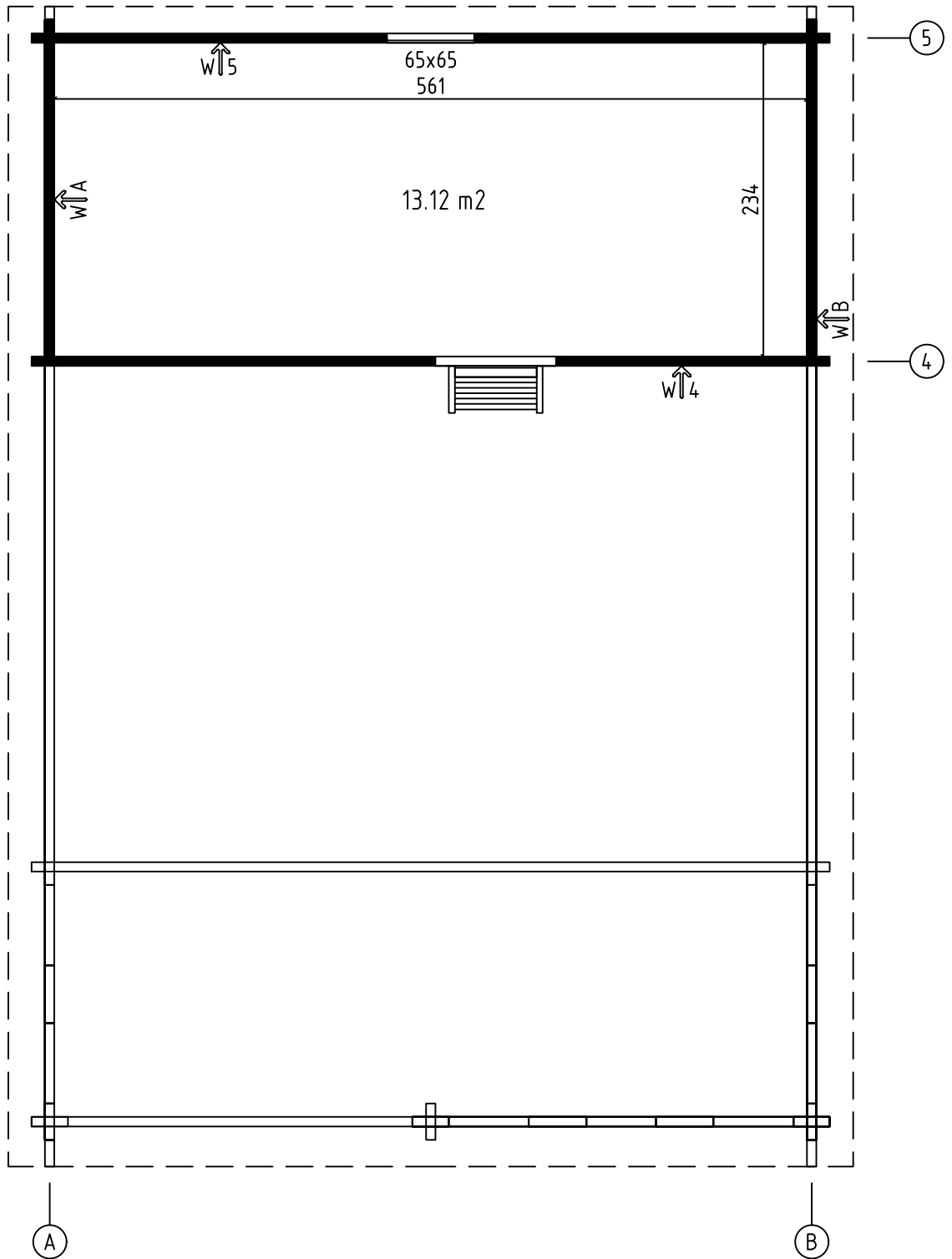







Han 70, Art.No.7010441

Mezzanine floor joists - Halbgeschoss balken - Solives de plancher mezzanine - Travi del pavimento mezzanino - Plaatduim scharnier - Vahelaetalad

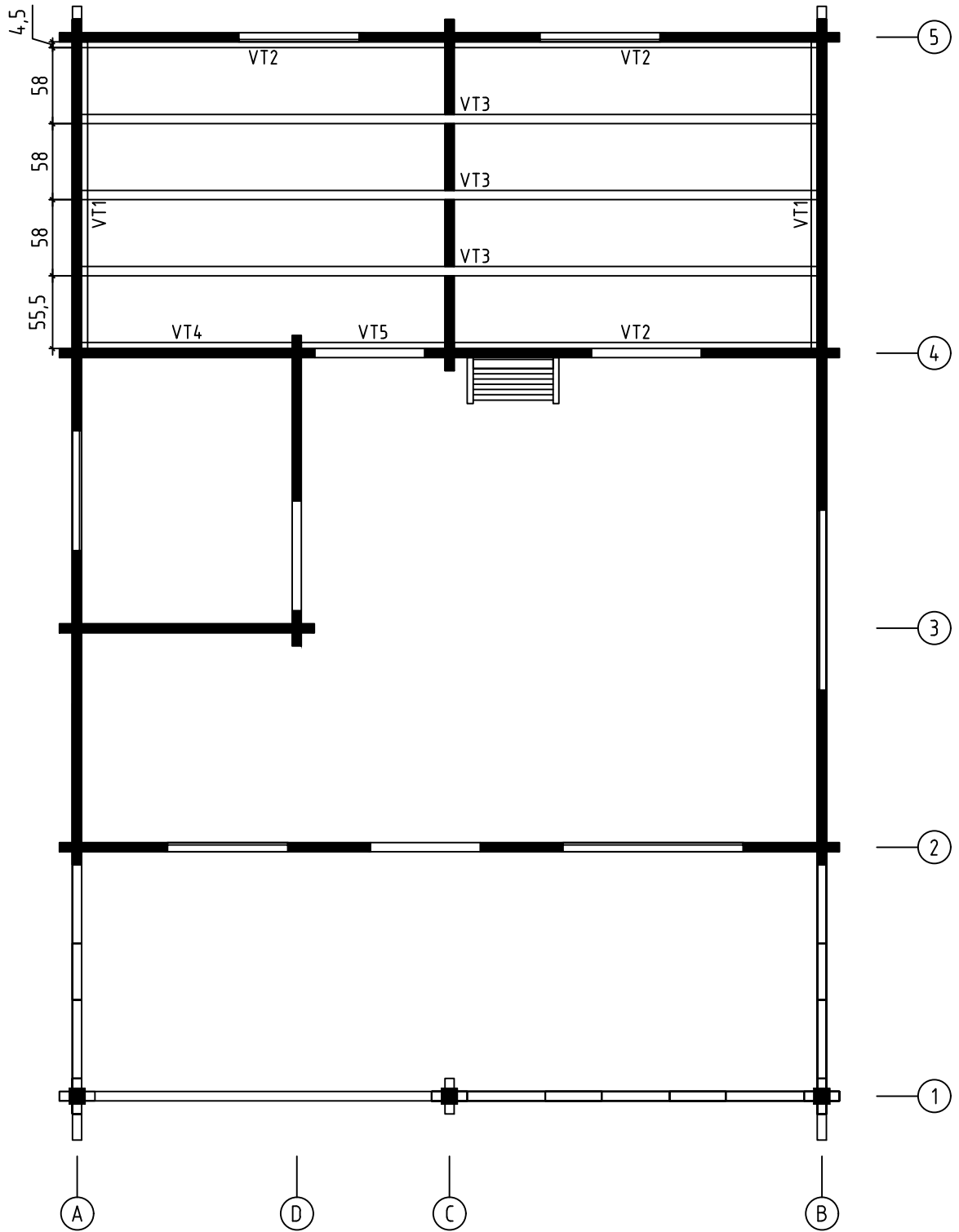

Floor boards - Fussbodenbretter - Lame de plancher - Pavimento - Vloerhout - Põrandalaud

Terrace boards - Terrassenbretter - Plancher de terrasse - Piattaforme terrazzo - Terrasyloer - Terrassilaudis

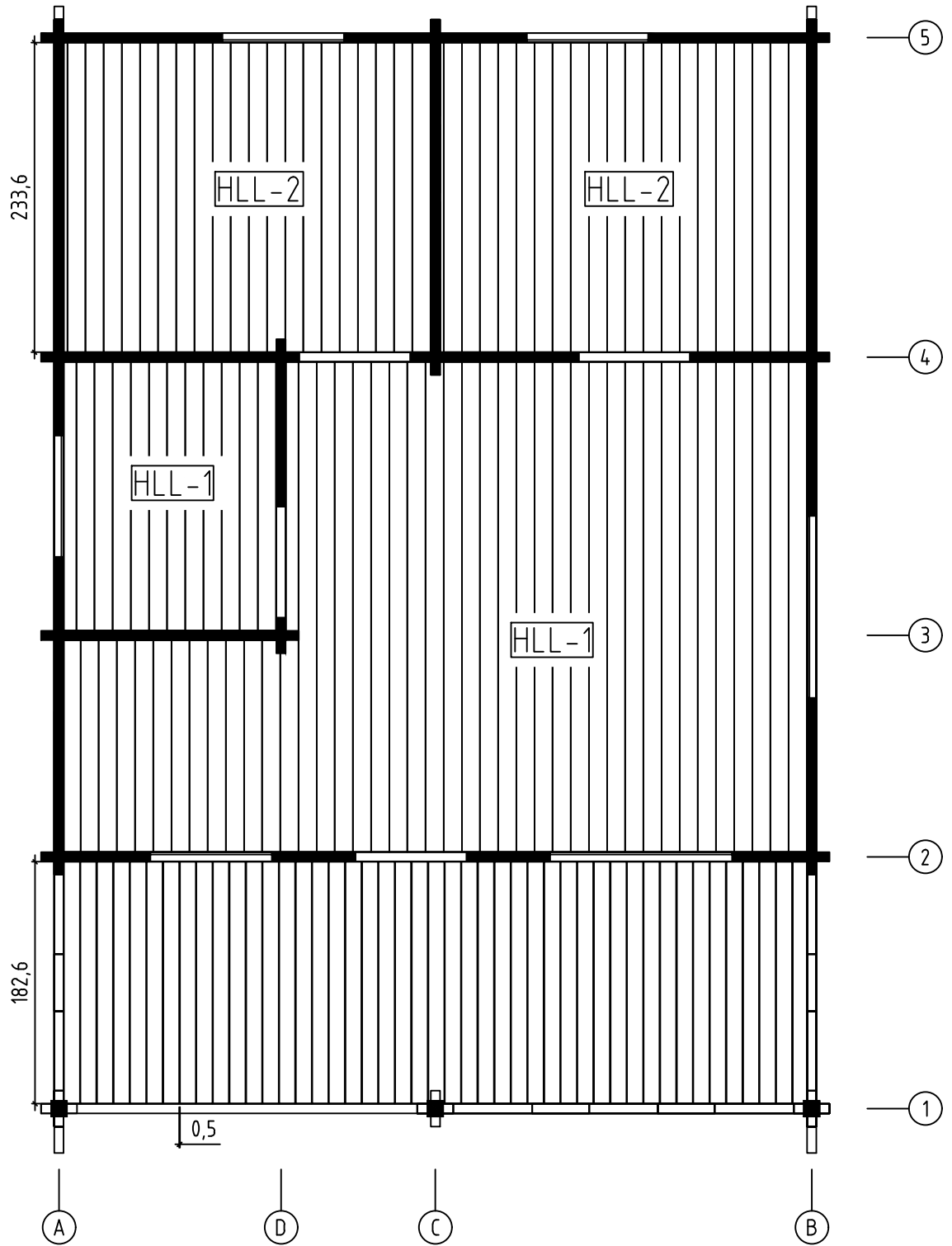

Han 70, Art.No.7010441

Floor boards - Fussbodenbretter - Lame de plancher - Pavimento - Vloerhout -  
Põrandalaud

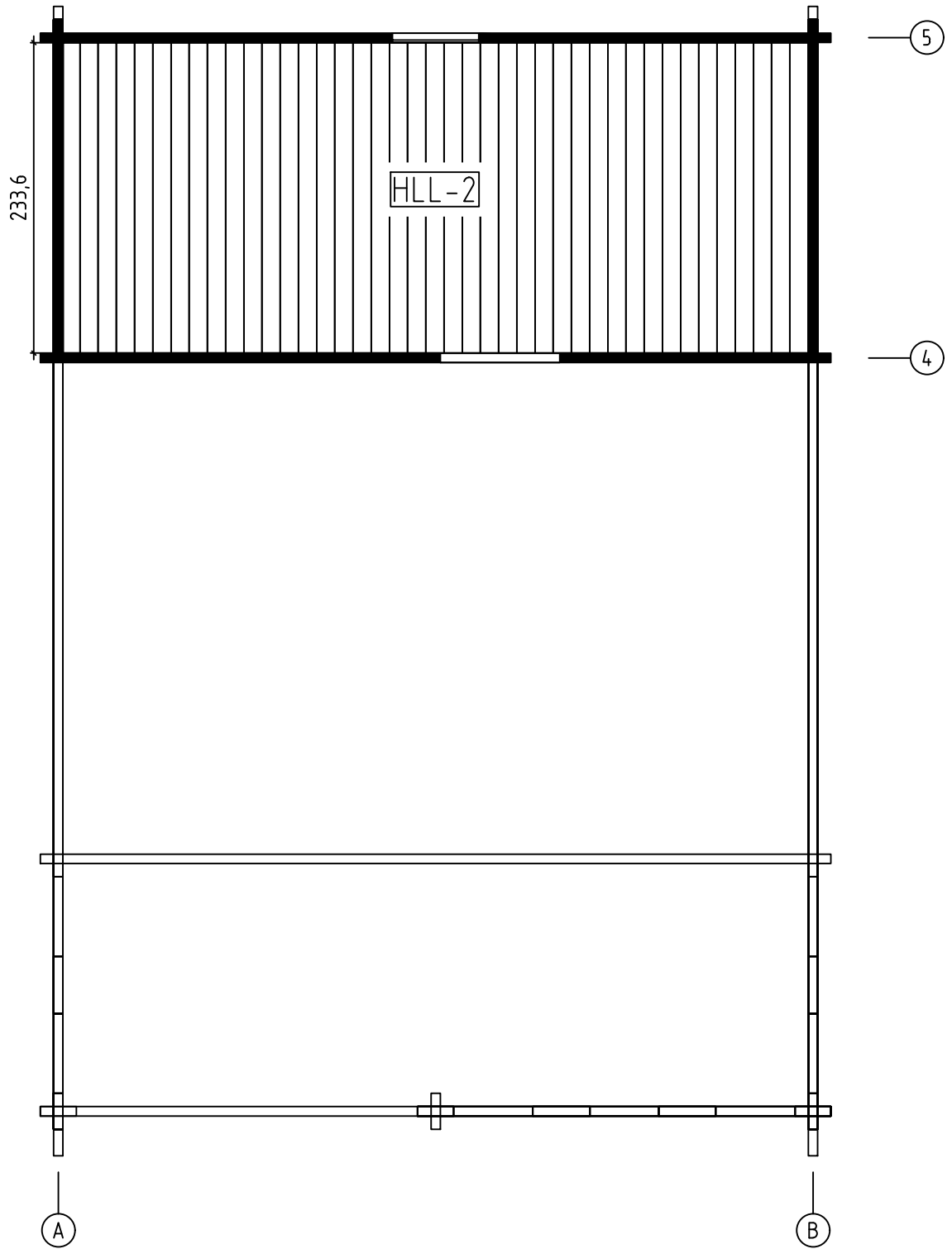

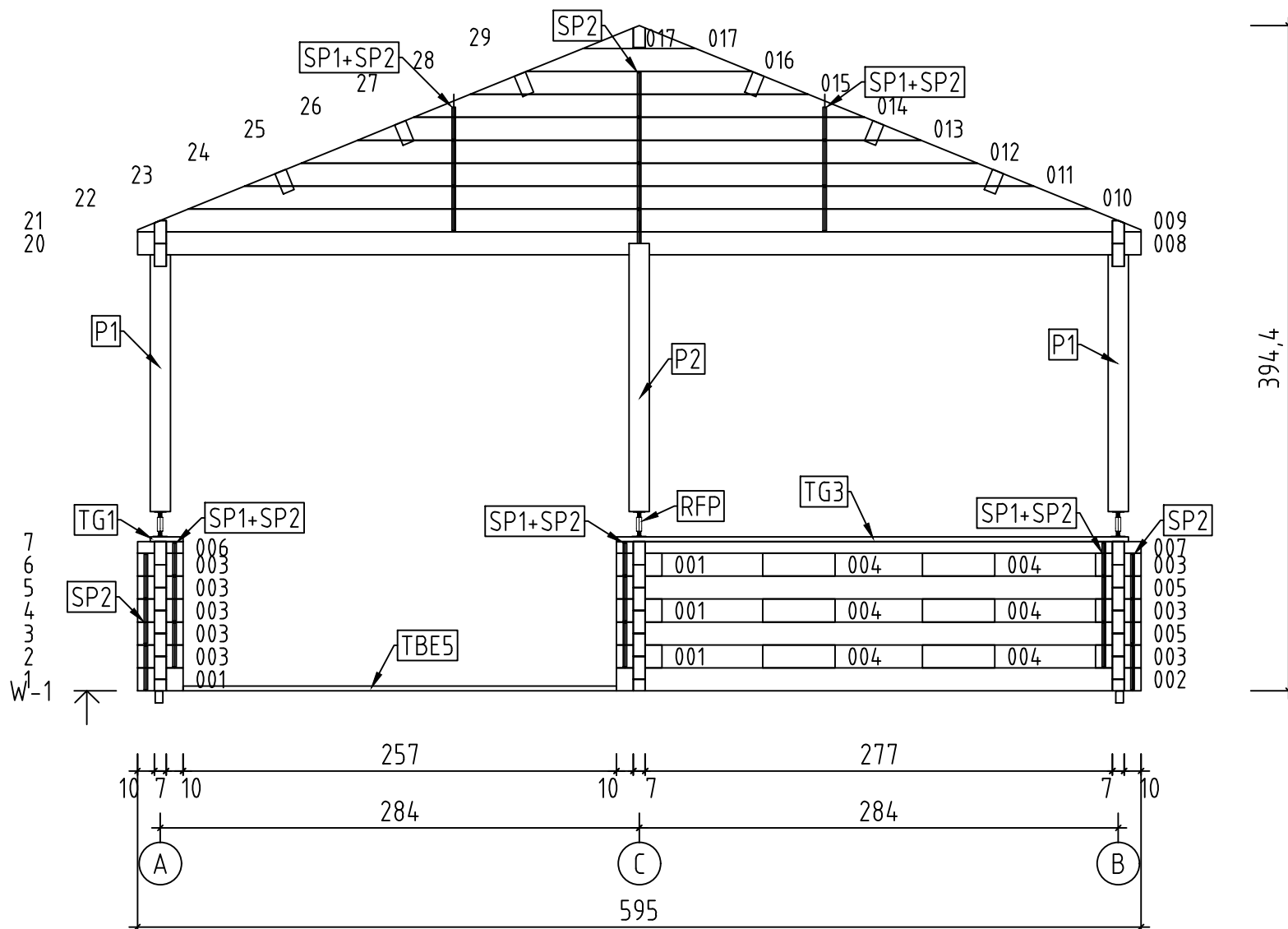

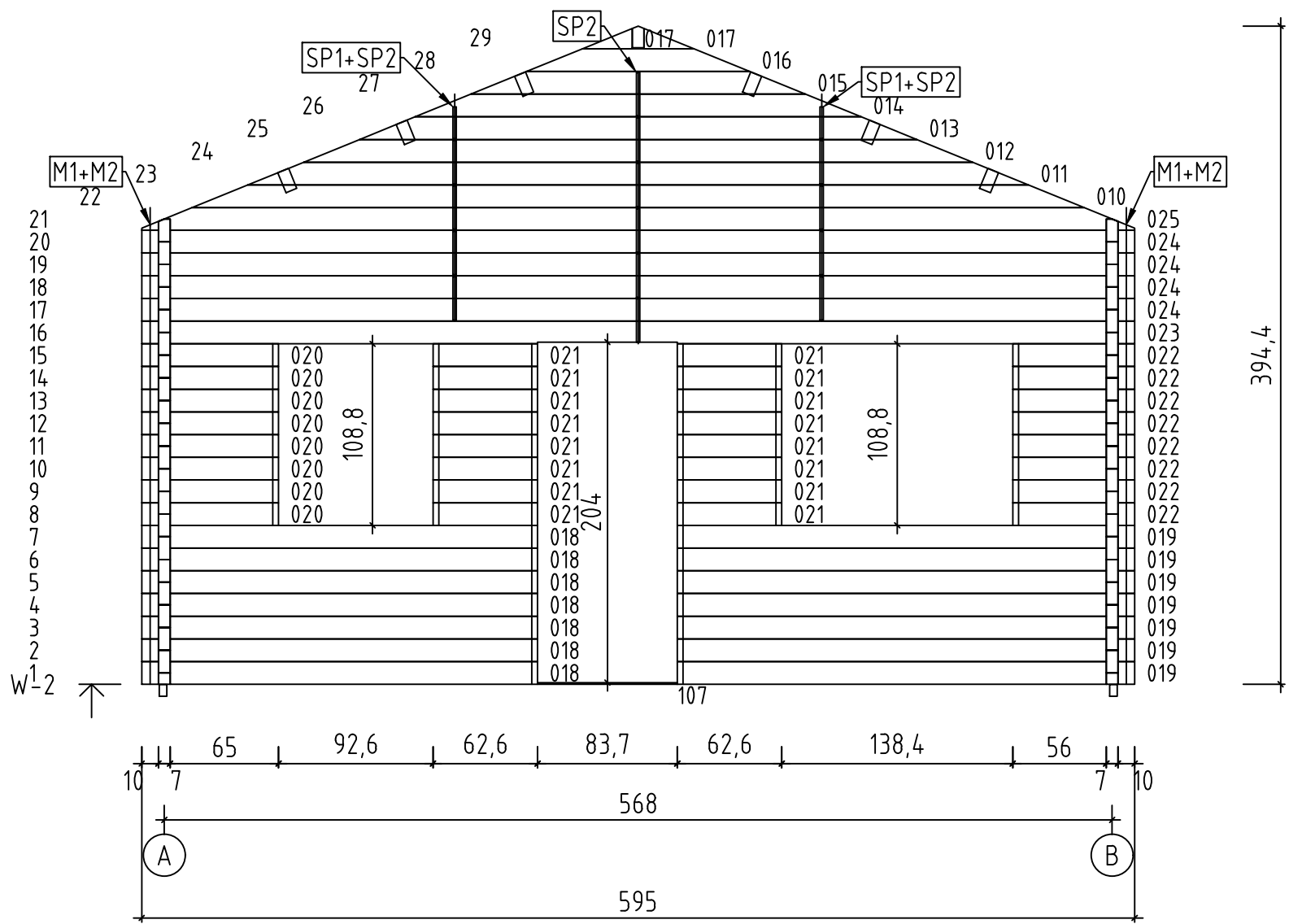

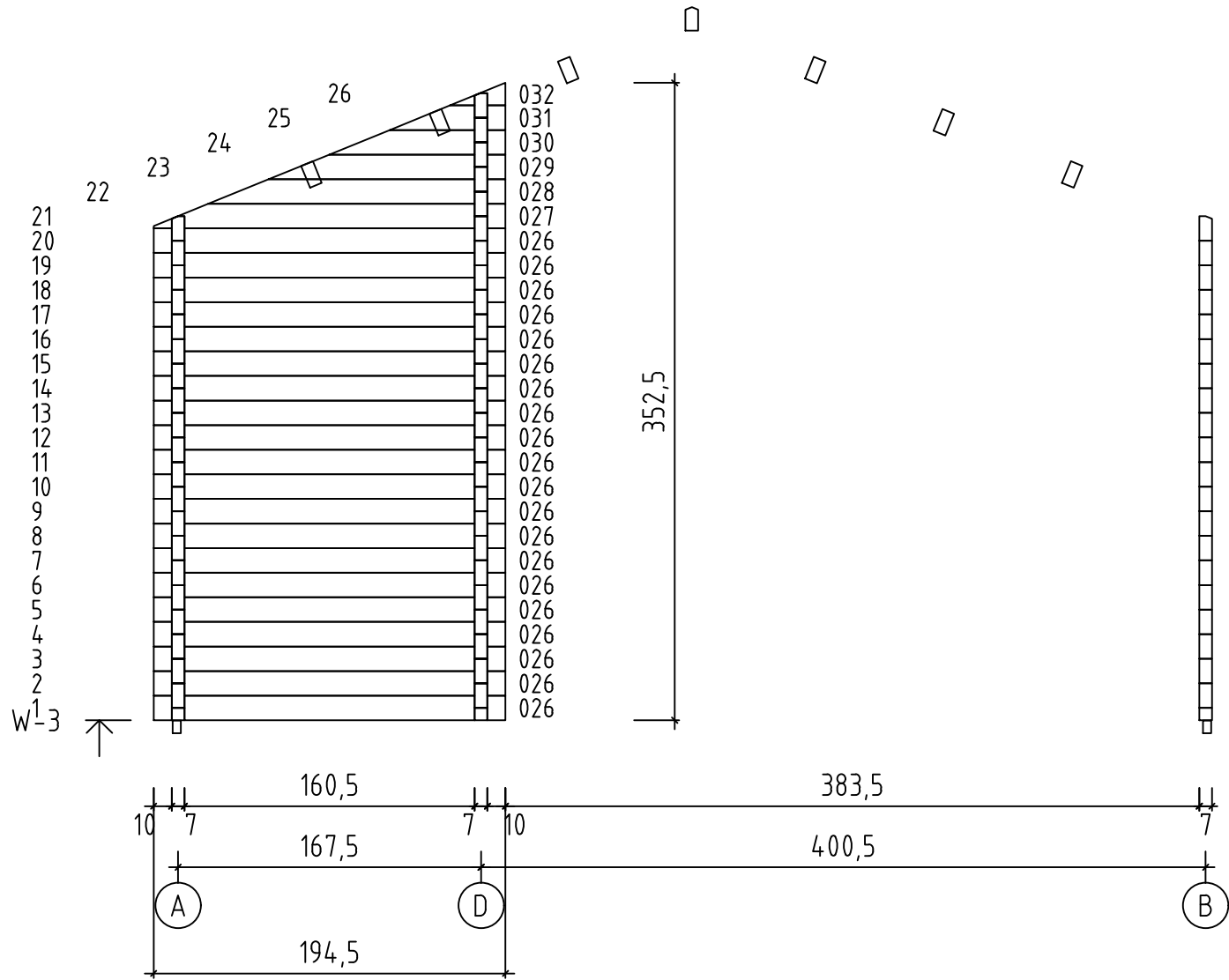

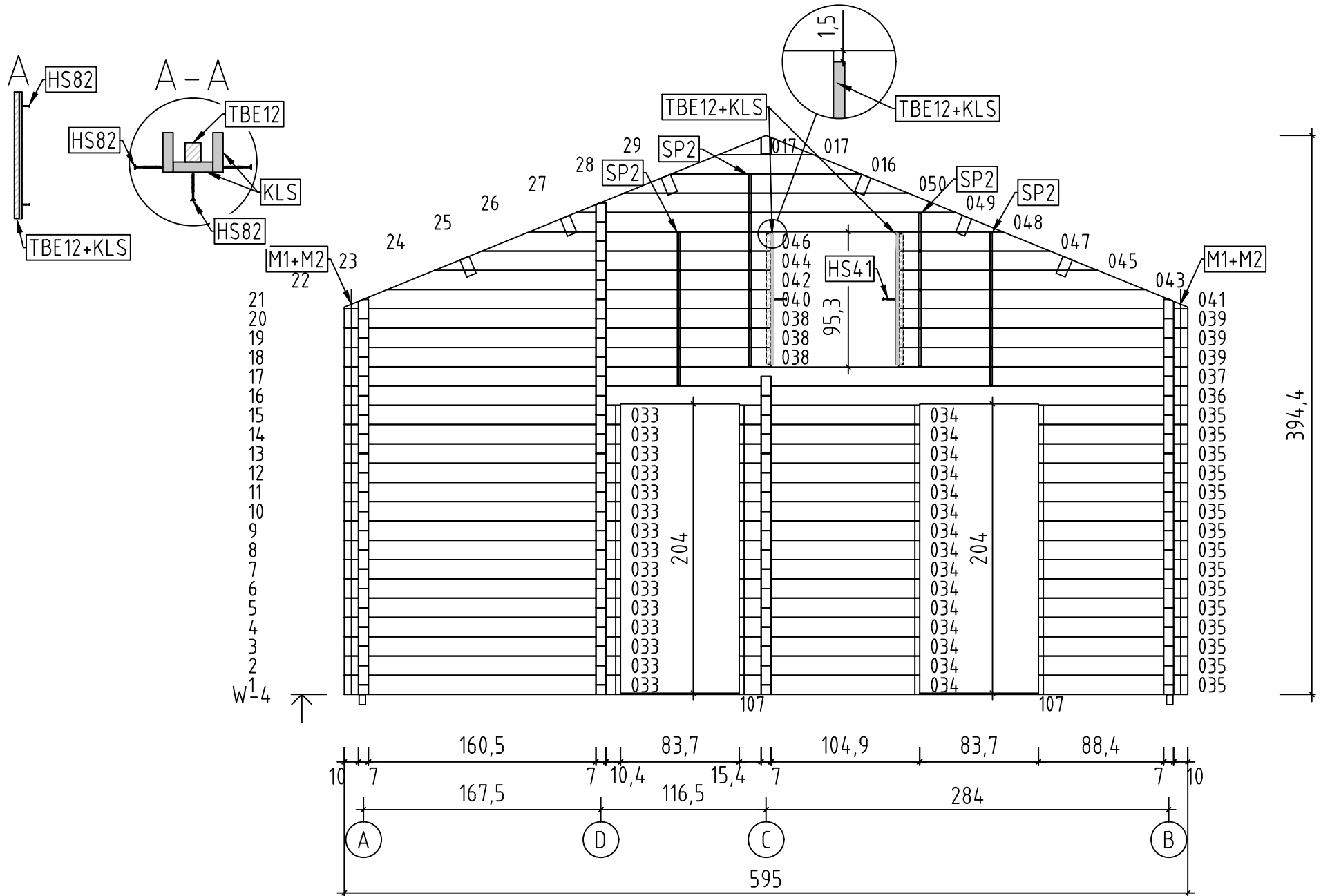







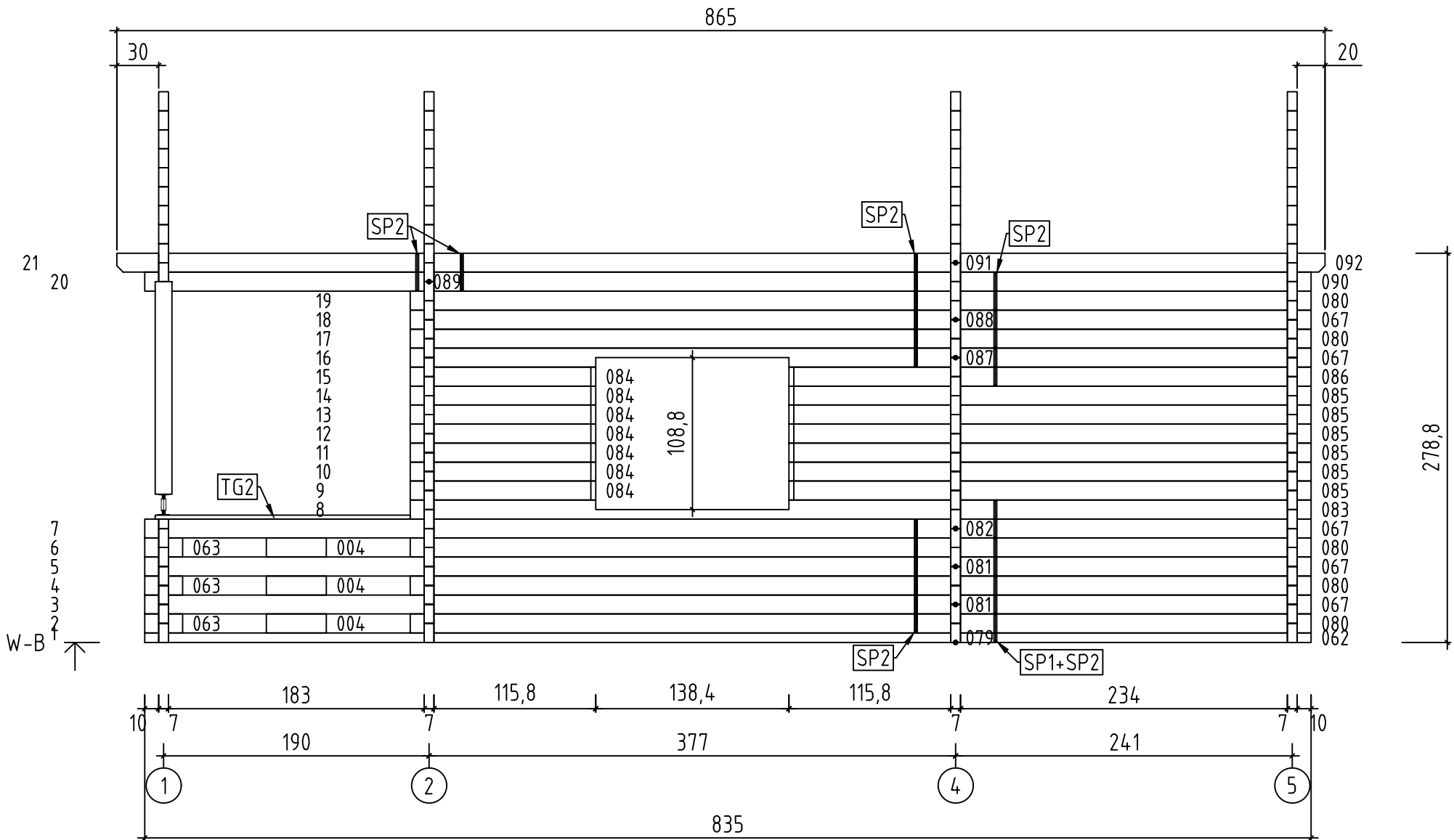

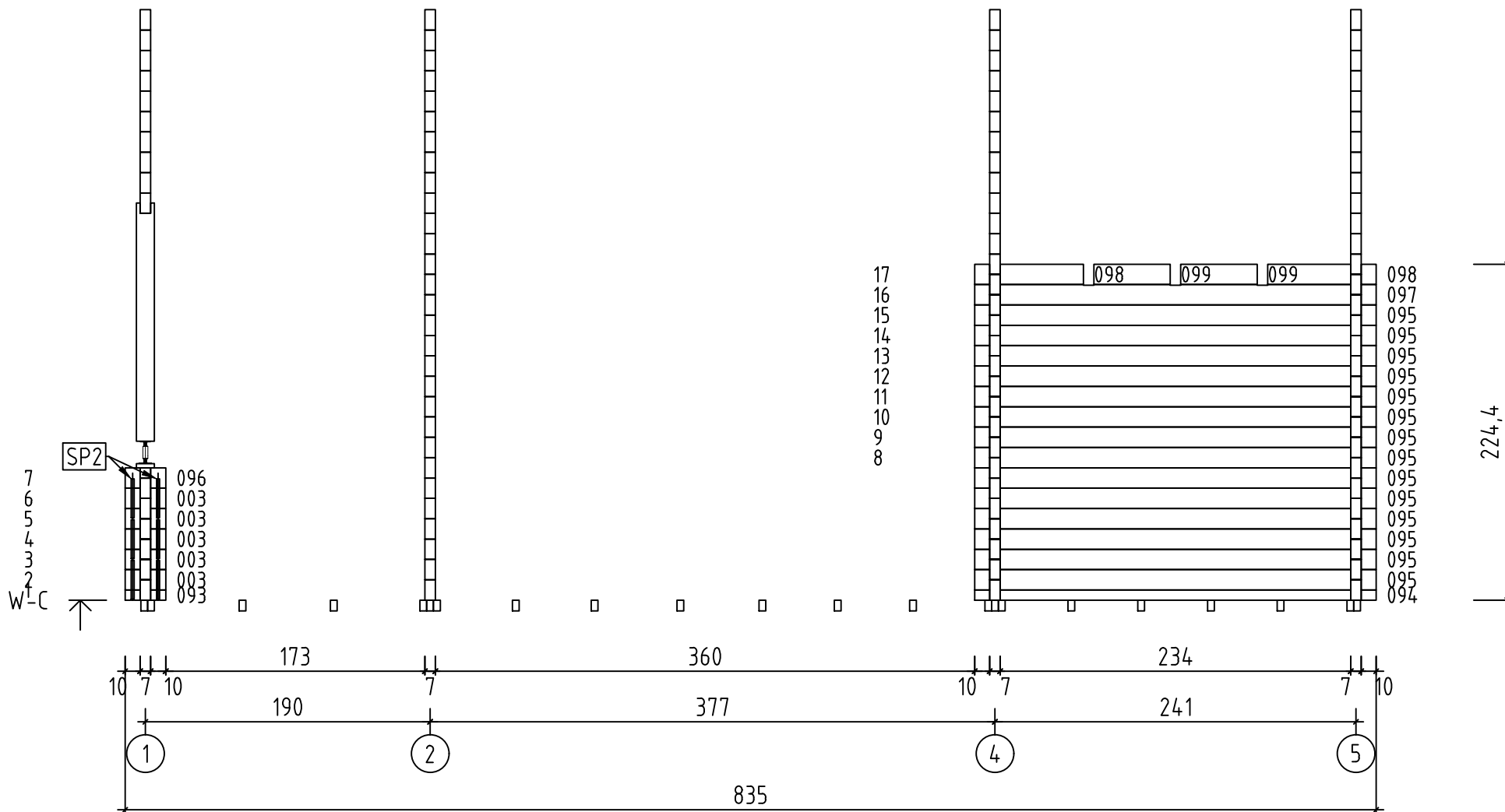



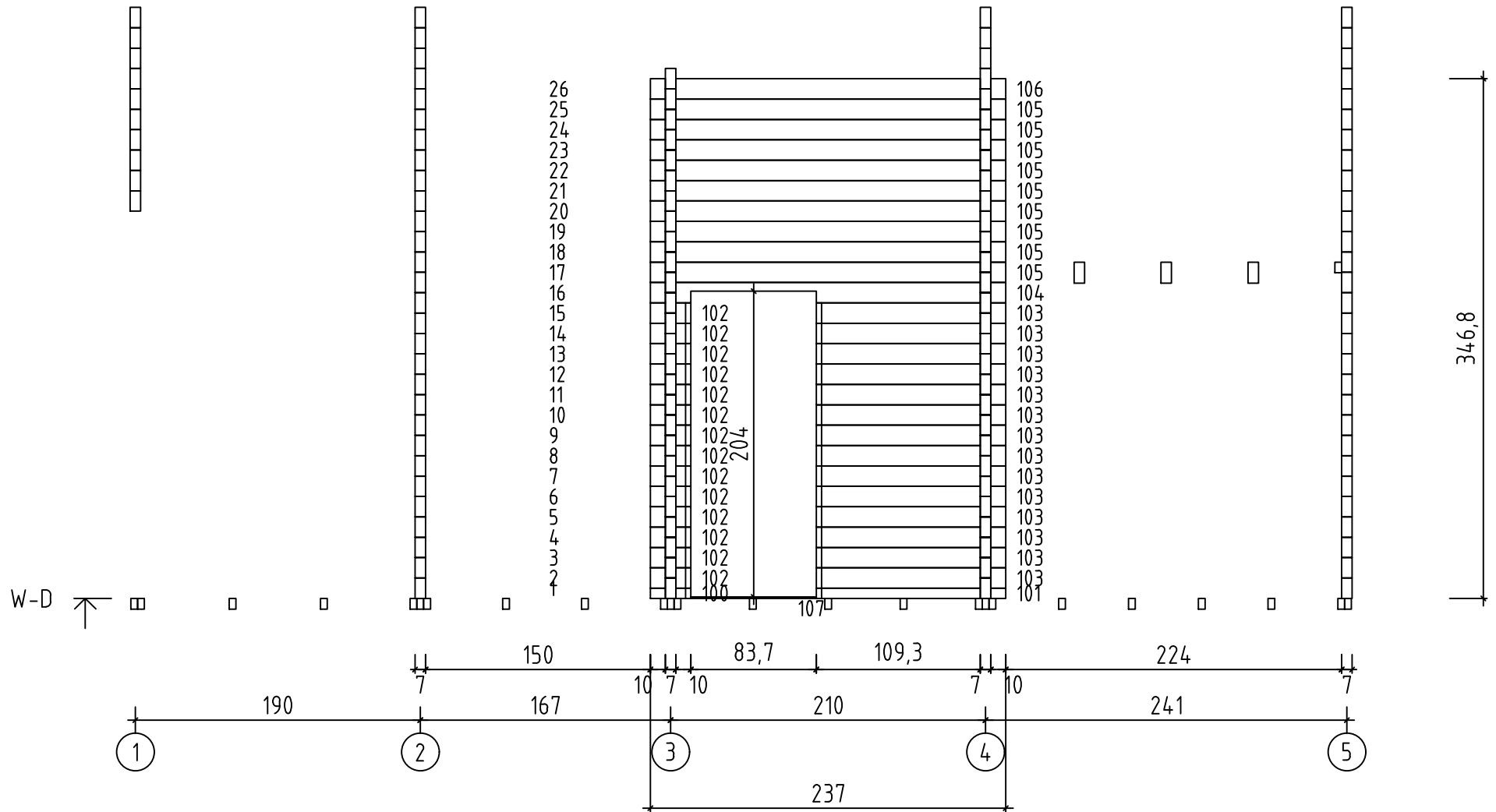



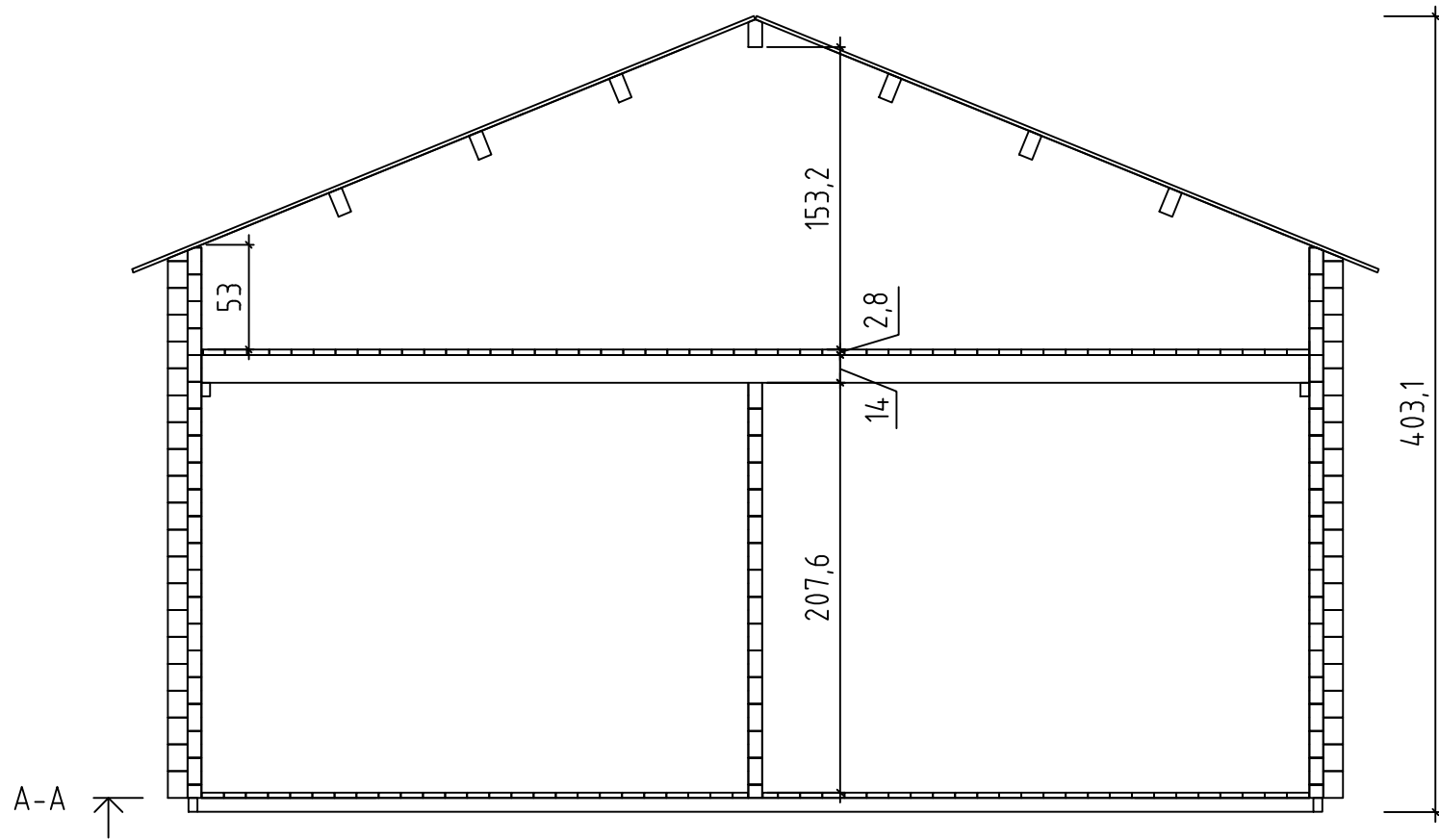



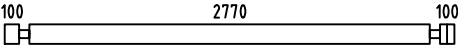

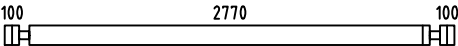

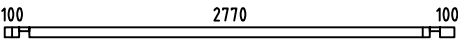
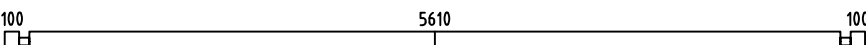
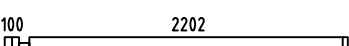
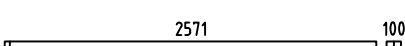
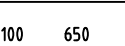

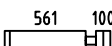
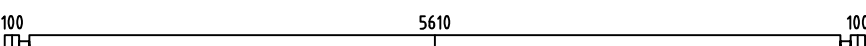
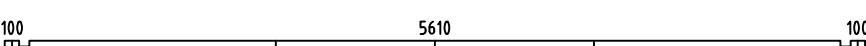
Han 70, Art.No.7010441

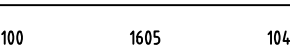
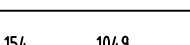
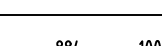
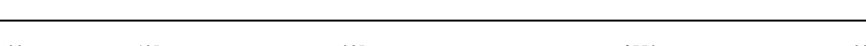
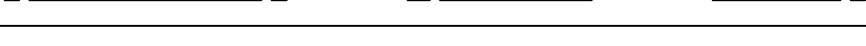
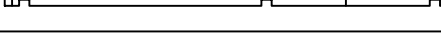
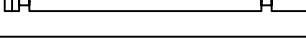

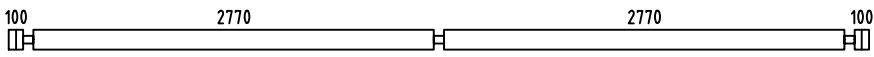
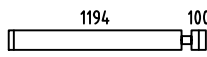
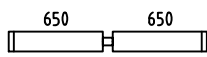
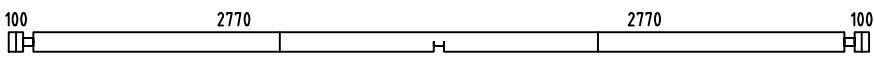
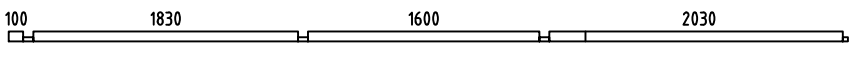
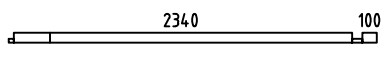

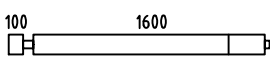
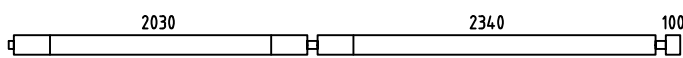
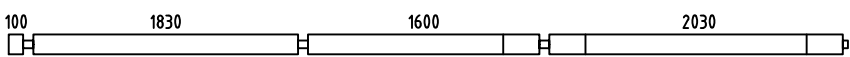
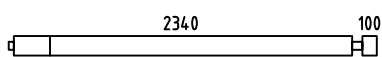
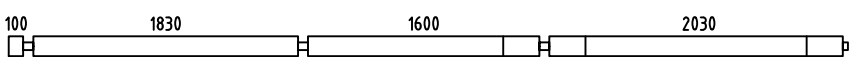

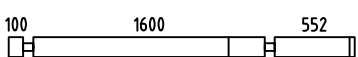
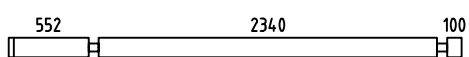
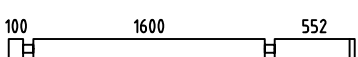

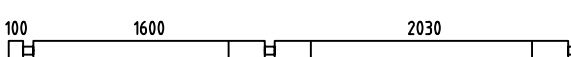
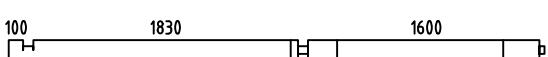
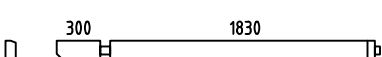
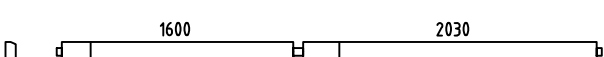
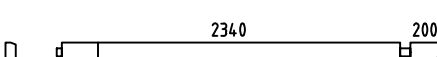
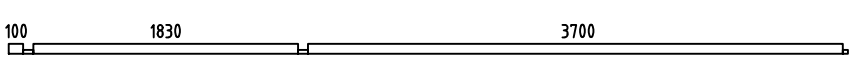

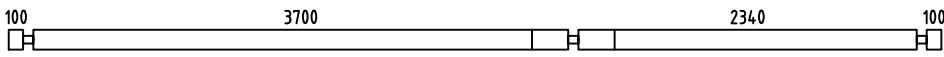
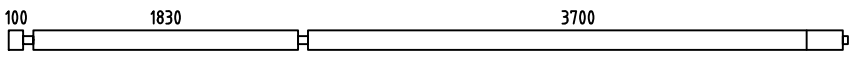
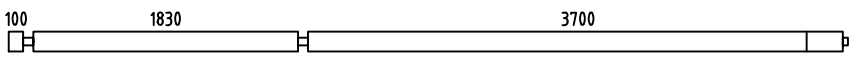
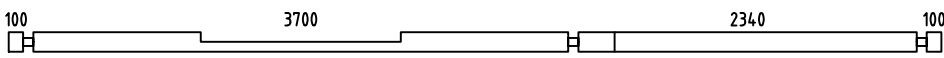
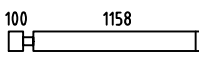
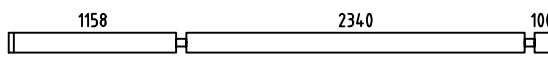
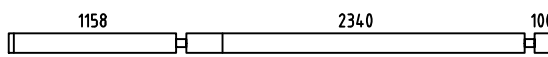
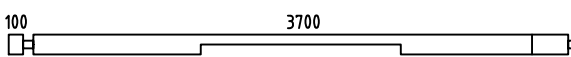
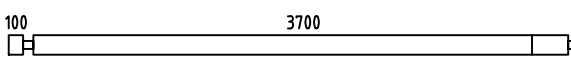
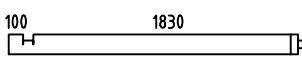
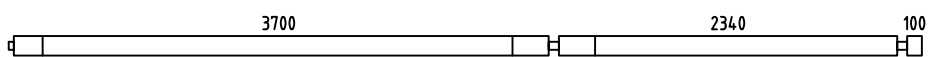
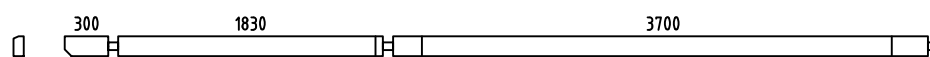
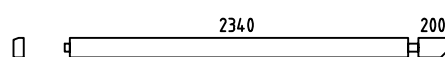
Han 70, Art.No.7010441

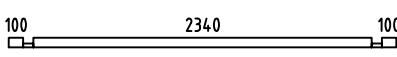
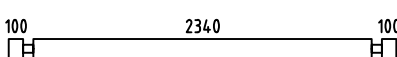

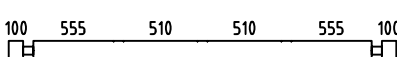
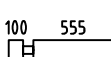

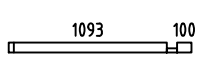





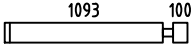
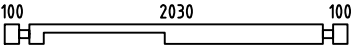
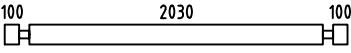
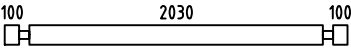

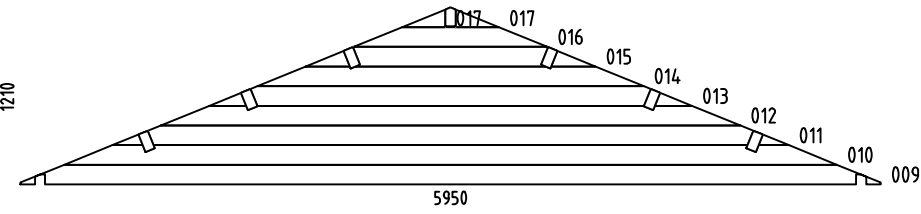
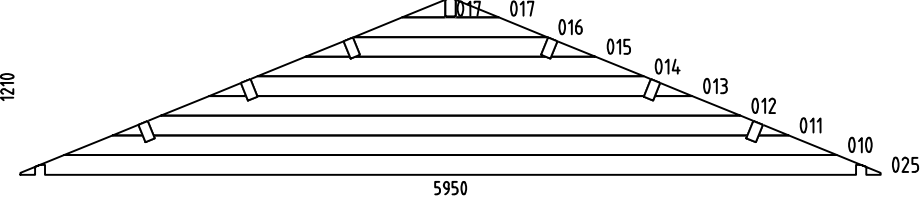
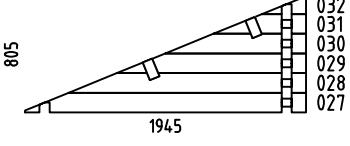
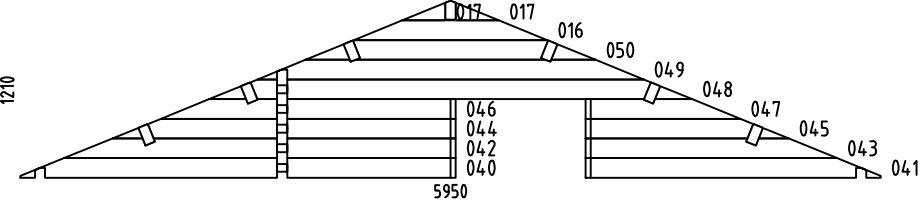
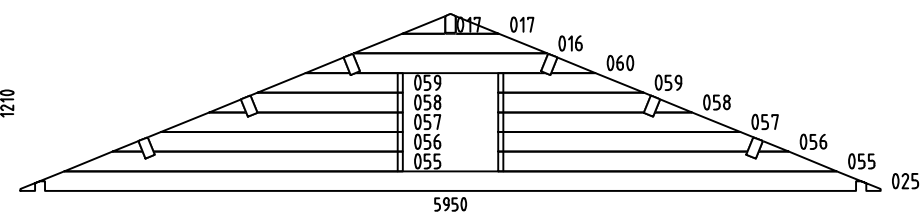
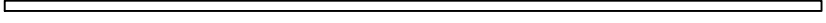
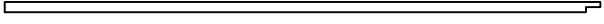
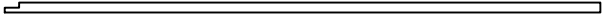
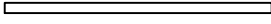

Pos	Han 70, Art.No.7010441 Piece list - Stückliste - Liste des pièces - Elementi - Stuklijst - Tükítabel	Q	P (mm)	L (mm)
001	100100 	4	70x136	270
002	100 2770 100 	1	70x136	3110
003	100100 	13	70x136	270
004		12	70x136	430
005	100 2770 100 	2	70x136	3110
006	100100 	1	70x68	270
007	100 2770 100 	1	70x68	3110
008	100 5610 100 	1	70x136	5950
018	100 2202 	7	70x136	2372
019	2571 100 	7	70x136	2741
020	100 650 	8	70x136	820
021		16	70x136	626
022	561 100 	8	70x136	731
023	100 5610 100 	1	70x136	5950
024	100 5610 100 	7	70x136	5950
026	100 1605 100 	20	70x136	1945
033	100 1605 104 	15	70x136	1949
034	154 1049 	15	70x136	1273
035	884 100 	15	70x136	1054
036	100 1605 1095 2770 100 	1	70x136	5950
037	100 1605 1095 2770 100 	1	70x136	5950
038	100 1605 1165 	3	70x136	3010
039	1870 100 	3	70x136	2040

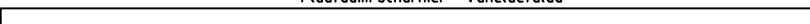
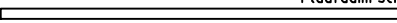
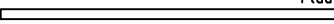
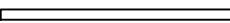
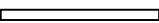
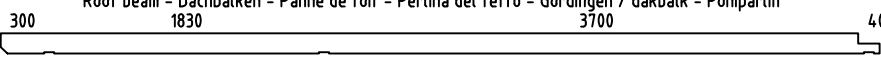
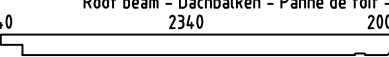
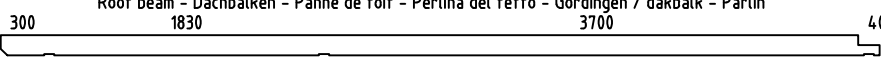
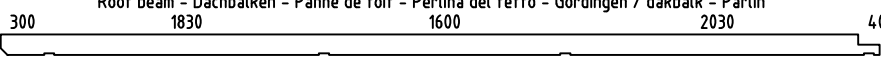
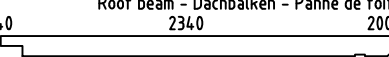

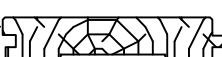





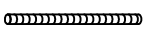
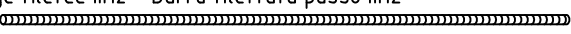
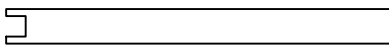
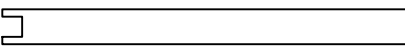

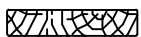



Pos	Han 70, Art.No.7010441 Piece list - Stückliste - Liste des pièces - Elementi - Stuklijst - Tükítabel	Q	P (mm)	L (mm)
051		8	70x136	5950
052		16	70x136	1364
053		8	70x136	1370
054		1	70x136	5950
061		1	70x68	5805
062		2	70x68	2545
063		6	70x136	270
064		6	70x136	1805
065		5	70x136	4645
066		2	70x136	5805
067		10	70x136	2545
068		1	70x136	5805
069		1	70x136	4645
070		2	70x136	2392
071		7	70x136	3132
072		5	70x136	2392
073		1	70x136	4645
074		2	70x136	3905
075		1	70x136	3705
076		1	70x136	2235
077		1	70x136	3770
078		1	70x136	2645
079		1	70x68	5805



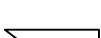
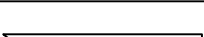
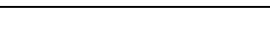
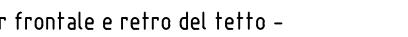





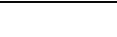
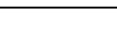
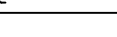
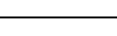
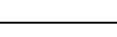











Pos	Han 70, Art.No.7010441 Piece list - Stückliste - Liste des pièces - Elementi - Stuklijst - Tükítabel	Q	P (mm)	L (mm)
080		5	70x136	6450
081		2	70x136	5805
082		1	70x136	5805
083		1	70x136	6450
084		7	70x136	1328
085		6	70x136	3738
086		1	70x136	3738
087		1	70x136	3905
088		1	70x136	3905
089		1	70x136	2035
090		1	70x136	6315
091		1	70x136	6005
092		1	70x136	2645
093		1	70x68	270
094		1	70x68	2680
095		14	70x136	2680
096		1	70x136	270
097		1	70x136	2680
098		2	70x136	725
099		2	70x136	510
100		1	70x68	270
101		1	70x68	1263
102		14	70x136	270

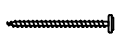
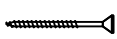

Pos	Han 70, Art.No.7010441 Piece list - Stückliste - Liste des pièces - Elementi - Stuklijst - Tükítabel	Q	P (mm)	L (mm)
103		14	70x136	1263
104		1	70x136	2370
105		9	70x136	2370
106		1	70x136	2370
107		4	70x10	837
W1-1		1		
W2-1		1		
W3-1		1		
W4-1		1		
W5-1		1		
IAR4	Foundation - Fundament - Fondation - Fondamenta - Fundering - Immutatud alusraam 	22	45x70	5650
IAR1	Foundation - Fundament - Fondation - Fondamenta - Fundering - Immutatud alusraam 	2	45x70	4120
IAR2	Foundation - Fundament - Fondation - Fondamenta - Fundering - Immutatud alusraam 	2	45x70	4120
IAR5	Foundation - Fundament - Fondation - Fondamenta - Fundering - Immutatud alusraam 	2	45x70	1845

Pos	Han 70, Art.No.7010441 Piece list - Stückliste - Liste des pièces - Elementi - Stuklijst - Tükítabel	Q	P (mm)	L (mm)
IAR3	Foundation - Fundament - Fondation - Fondamenta - Fundering - Immutatud alusraam 	4	45x70	458
VT3	Mezzanine floor joists - Halbgeschoss balken - Solives de plancher mezzanine - Travi del pavimento mezzanino - Plaatduim scharnier - Vahelaetalad 	3	70x140	5610
VT2	Mezzanine floor joists - Halbgeschoss balken - Solives de plancher mezzanine - Travi del pavimento mezzanino - Plaatduim scharnier - Vahelaetalad 	3	45x70	2770
VT1	Mezzanine floor joists - Halbgeschoss balken - Solives de plancher mezzanine - Travi del pavimento mezzanino - Plaatduim scharnier - Vahelaetalad 	2	45x70	2340
VT4	Mezzanine floor joists - Halbgeschoss balken - Solives de plancher mezzanine - Travi del pavimento mezzanino - Plaatduim scharnier - Vahelaetalad 	1	45x70	1605
VT5	Mezzanine floor joists - Halbgeschoss balken - Solives de plancher mezzanine - Travi del pavimento mezzanino - Plaatduim scharnier - Vahelaetalad 	1	45x70	1095
PR1	Roof beam - Dachbalken - Panne de toit - Perlina del tetto - Gordingen / dakbalk - Põhipärtin 	1	70x140	6080
PR2	Roof beam - Dachbalken - Panne de toit - Perlina del tetto - Gordingen / dakbalk - Põhipärtin 	1	70x140	2720
PR23	Roof beam - Dachbalken - Panne de toit - Perlina del tetto - Gordingen / dakbalk - Pärtin 	4	70x140	6080
PR21	Roof beam - Dachbalken - Panne de toit - Perlina del tetto - Gordingen / dakbalk - Pärtin 	2	70x140	6080
PR22	Roof beam - Dachbalken - Panne de toit - Perlina del tetto - Gordingen / dakbalk - Pärtin 	6	70x140	2720
HLL-1	Floor boards - Fussbodenbretter - Lame de plancher - Pavimento - Vloerhout Põrandalaud 		137x28	165 m.
HLL-2	Floor boards - Fussbodenbretter - Lame de plancher - Pavimento - Vloerhout Põrandalaud 	83	137x28	2336
RB-1	Roof boards - Dachbretter - Voliges - Perlina per tetto - Dakhout - Katuselaud 	194	90x18	3400
SV2-1	Terrace boards - Terrassenbretter - Plancher de terrasse - Piattaforme terrazzo Terrasvloer - Terrassilaud 	45	120x28	1826
FL-1	Floor fillet - Fussbodenleiste - Corniere de finition du plancher - Finitura per pavimento (battisco pa) - Vloerafwerklijt - Põrandaliist 		15x40	63 m.
KLS	Batten - Deckleiste - Profils de finition angles a l'exterieur - Asse - Afdek lijst - Katteliis 	6	18x70	920
TBE5	Terrace edge board - Terrassenbrett, eingang - Lame de seuil d'entree de terrasse - Terrazzo uso abitacolo - Terrasvloer dorpel - Terrassi servaliist 	1	28x70	2570
DPL-1	Roofing felt fillet - Dachpappenleiste - Bague de fixation du feutre bitumeux - Asse per fissaggio guaina bituminosa - Afdeklijst asfaltpapier - Katusepapiiist 	4	18x58	3450
M1	Treaded rod m12 - Gewindestange m12 - Tige filetée m12 - Barra filettata passo m12 - Draadstang 12m - Keermelatt 	6		785
M2	Treaded rod m12 - Gewindestange m12 - Tige filetée m12 - Barra filettata passo m12 - Draadstang 12m - Keermelatt 	6		2000
P1	Post - Pfosten - Poteau - Piede registrabile - Stijl - Post 	2	120x120	1522
P2	Post - Pfosten - Poteau - Piede registrabile - Stijl - Post 	1	120x120	1590

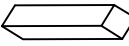
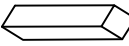
Pos	Han 70, Art.No.7010441 Piece list - Stückliste - Liste des pièces - Elementi - Stuklijst - Tükítabel	Q	P (mm)	L (mm)
TB-1	Fascia board - Traufbrett - Bandeau de toit - Finitura lati tetto - Gevellijst - Räästalaud 	4	18x90	4325
DRV-1	Roof edge reinforcement - Dachrandverstärkung - Corniere de renfort de bord de toit - Rinforzo x tetto - Dakrand versterking - Räästafugevdus 	4	28x34	4325
TBE12	Fixing fillet - Fixierungsleiste - Profil de fixation - Massello di fissaggio - Bevestiging lijstwerk - Tenderliist 	2	28x34	920
TBE6-1	Fixing fillet - Fixierungsleiste - Profil de fixation - Massello di fissaggio - Bevestiging lijstwerk - Tenderliist 	2	28x34	650
TBE6-2	Fixing fillet - Fixierungsleiste - Profil de fixation - Massello di fissaggio - Bevestiging lijstwerk - Tenderliist 	4	28x34	884
TBE6-3	Fixing fillet - Fixierungsleiste - Profil de fixation - Massello di fissaggio - Bevestiging lijstwerk - Tenderliist 	8	28x34	1050
TBE6-1	Fixing fillet - Fixierungsleiste - Profil de fixation - Massello di fissaggio - Bevestiging lijstwerk - Tenderliist 	2	28x34	1894
TBE6-2	Fixing fillet - Fixierungsleiste - Profil de fixation - Massello di fissaggio - Bevestiging lijstwerk - Tenderliist 	6	28x34	1990
TG1	Guard-rail for terrace - Terrassengeländer - Main courante de terrasse - Guardrail per terrazzo - Terras leuning - Terrassi äärelaud 	1	28x120	195
TG2	Guard-rail for terrace - Terrassengeländer - Main courante de terrasse - Guardrail per terrazzo - Terras leuning - Terrassi äärelaud 	2	28x120	1825
TG3	Guard-rail for terrace - Terrassengeländer - Main courante de terrasse - Guardrail per terrazzo - Terras leuning - Terrassi äärelaud 	1	28x120	3035
GL-1	Gable moulding - Giebelleiste - Planche de rive - Finitura per frontale e retro del tetto - Gevellijst - Viilulaud 	4	18x120	3450
KL4	Lengthening bolt for threaded rod - Verlängerungsmutter für gewindestange - Manchon de raccordement de tige filetée - Bullone per barra filettata passo - Extensie moer voor draadstang - Jätikumutter keermelatile 	6		
KL1	Drive nut threaded rod - Einschlagmutter für gewindestange - Écrou a frapper pour tige filitée - Dado guida per barra filettata - Aandrijfmoer / aanslagmoer voor draadstang - Löökmutter keermelatile 	6		
KL2	Nut for threaded rod - Mutter für gewindestange - Écrou pour tige filitée - Dado per barra filettata - Moer voor draadstang - Mutter keermelatile 	6		
KL3	Plain washer threaded rod - Unterlegscheibe für gewindestange - Rondelle plate pour tige filitée - Rondella per barra filettata - Sluiring voor draadeind - Seib keermelatile 	6		
HS12	Screw for gable segment - Schrauben für deckblatt - Vis pour fixation losange de finition - Viti x frontali tetto - Schroef voor gevelpunt segment - Krugi rombile 	4	3.5x35	
HS82	Screw for batten - Schrauben für deckleisten - Vis de fixation profils de finition angles a l'exterieur - Viti per stecca d'angolo - Schroef voor afdeklát - Krugi katteliistule 	16	3.5x50	
HS25	Screw for floor - Schrauben für fussbodenbretter - Vis pour plancher - Viti per le perline del pavimento - Schroef voor vloerhout - Krugi põrandale 	1050	3.5x50	
HS84	Screw for fixing fillet of door and window - Schrauben für fixierungsleiste - Vis pour profil vertical de fixation pour ouvertures des fenetres et portes - Viti per massello di fissaggio - Schroeven voor bevestiging van deur en raam lijsten - Krugi tenderliistudele 	86	3.5x50	
HS16	Screw for gable moulding - Schrauben für giebelleiste - Vis pour fixation planche de rive - Vite per fissare finiture davanti e dietro del tetto - Schroef voor gevellijst - Krugi viilulauale 	40	3.5x50	
HS32	Screw for fascia boards - Schrauben für traufbretter - Vis pour fixation bandeau de toit - Viti x striscia del tetto - Schroef voor gevellijst - Krugi räästalauale 	40	4x40	
HS26	Screw for roof edge reinforcement - Schrauben für dachrandverstärkung - Vis pour fixation corniere renfort de bord de toit - Viti x rinforzo bordo tetto - Schroef voor dakrand versterking - Krugi räästafugevdusele 	40	4x40	

Pos	Han 70, Art.No.7010441 Piece list - Stückliste - Liste des pièces - Elementi - Stuklijst - Tükítabel	Q	P (mm)	L (mm)
HS46	Screw for foundation - Schrauben zur befestigung fundament - Vis de fixations des poutrelles de fondations - Viti x fundamenta - Schroef voor fundering - Kruvi alusraamile 	4	4x60	
HS34	Screw for post - Schrauben für pfosten - Vis de fixation des poteaux - Viti per inviare - Schroef voor stijlen - Kruvi postile 	6	4x60	
HS36	Screw for stepladder - Schraube für leiter - Vis d'assemblage des marches de l'échelle - Vite per scaletta - Schroef voor trapladder - Kruvi redeli montaažiks 	36	4x60	
HS30	Screw for terrace rear boards - Schrauben für terrassenrand - Vis de fixation pour main courante de terrasse - Vite per il piano posteriore della terrazza - Schroef voor terras afsluitplint (achterzijde) - Kruvi terrassi äärelaualle 	17	4x60	
HS89	Screw for beam - Schrauben zur befestigung dachsparren - Vis pour solive (s) - Viti per perline - Schroef voor balk (gording) - Kruvi talale 	59	5x100	
HS40	Screw for 1. wall beam - Schraube für 1. bohlenreihe - Vis de fixations 1ere rangée de madriers avec poutrelles de fondations - Vite fissaggio alle fondamenta - Schroef voor 1 wandbalk - Kruvi poollauale 	27	5x120	
HS42	Screw for gable - Schrauben für giebel - Vis pour fixation des pignons - Viti per timpano - Schroef voor gevelpunt - Kruvi kelba kinnitamiseks 	45	5x120	
HS43	Screw for roof beams - Schrauben für dachbalken - Vis pour fixation pannes de toit - Viti per perline del tetto - Schroef voor gordingen / dakbalken - Kruvi pärlinitele 	44	5x120	
HS78	Screw for pos.098;099 - Schrauben für pos.098;099 - Vis pour pos.098;099 - Viti per fissare elemento vedi figura in pos. n.098;099 - Schroef voor pos.098;099 - Kruvi pos.098;099 	5	5x120	
HS41	Screw for batten - Schrauben für deckleisten - Vis de fixation profils de finition angles a l'exterieur - Viti per stecca d'angolo - Schroef voor afdeklát - Kruvi katteliistule 	2	5x90	
HS39	Screw for foundation - Schrauben zur befestigung fundament - Vis de fixations des poutrelles de fondations - Viti x fundamenta - Schroef voor fundering - Kruvi alusraamile 	72	5x90	
HS49	Screw for post height adjustment - Schrauben für regulierungsschraube für pfosten - Vis de fixation de support réglable de poteau - Viti per fissare ed aggiustare l'altezza del palo verticale - Schroef voor hoogte instelling stijlen - Kruvi vajumispoldile 	24	6x50	
MS	Screw for doorstep - Schrauben für swelle - Vis pour fixation barre de seuil - Vite per soglia della porta - Schroef voor deurdorpel - Kruvi lävepakule 	8	4.5x65	
NF3	Screw for terrace - Schrauben für terrassenbretter - Vis pour fixation de terrasse - Viti per terrazza - Schroef voor terrasvloer - Kruvi terrassilauale 	365	4.2x55	
SH70	Hammer block - Schlagholz - Calle de frappe - Blocco di legno da usare come cuscinetto quando si usa il martello - Slagklos - Löögiklots 	2		
NFD	Zn nail for roofing felt fillet - Zn nägel für dachpappenleiste - Pointe pour baguette de fixation feutre bitumeux - Chiodi x carta bituminosa x tetto - Spijker(nagel) voor asfaltpapier afdeklíjst - Papiliistunael 	32	2x40	
NFF	Zn nail for floor fillet - Zn nägel für fußbodenteiste - Pointe pour corniere de finition du plancher - Chiodi x fissaggio pavimento - Spijker(nagel) voor vloer afdeklíjst - Nael põrandaliistule 	125	1.4x40	
NF2	Zn nail for roof - Zn nägel für dachbretter - Pointe pour fixation voliges de toit - Chiodi x perline tetto - Spijker(nagel) voor dakhout - Nael katuselaualle 	1015	2.1x50	
ORZ	Montage set for doors and windows - Montage-set für türen und fenster - Jeu de montage portes et fenetres - Set di assemblaggio per porte e finestre - Montage set voor deur en raam - Orthez akna ja ukse montaaipivahendid	1		
GS	Gable segment - Deckblatt - Losange de finition - Decorazione in legno x frontale tetto - Gevelpunt segment - Romb 	2		
SP1	Hidden fixing - Holzdübel - Tourillon bois - Fissaggio a scomparsa - Verloren kop spijker - Salapulk 	14		190
SP2	Hidden fixing - Holzdübel - Tourillon bois - Fissaggio a scomparsa - Verloren kop spijker - Salapulk 	110		260
RFP	Post height adjustment - Pfostenträger verstellbar - Support réglable de poteau - Piede registrabile in altezza - Stelschroef voor stijlpost - Vajumispolt 	3		

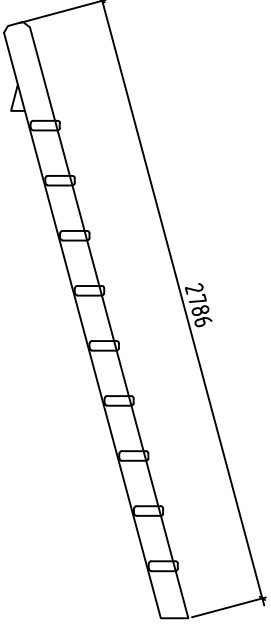
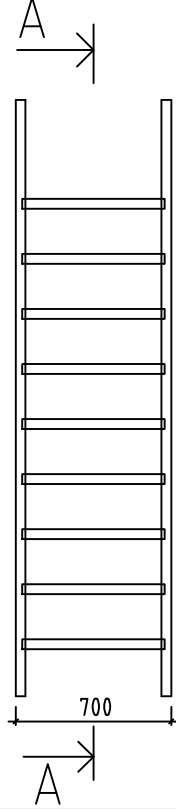
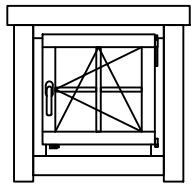
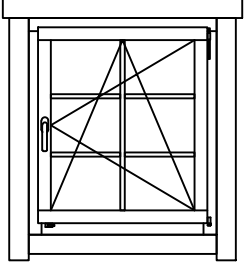
Pos	<p style="text-align: center;">Han 70, Art.No.7010441            Piece list - Stückliste - Liste des pièces - Elementi - Stuklijst - Tükítabel</p>	Q	P (mm)	L (mm)
LR	<p>Ladder - Leiter - Echelle - Scala a pioli - Ladder - Redel</p> <div style="display: flex; justify-content: space-around; align-items: center;"> <div style="text-align: center;"> <p><u>A-A</u></p>  </div> <div style="text-align: center;">  </div> </div>	1		
	<p>Window - Fenster - Fenetre - Finestra - Raam - Aken <span style="float: right;">650x650 2+ A.4P.K</span></p> <div style="text-align: center;">  </div>	1		
	<p>Window - Fenster - Fenetre - Finestra - Raam - Aken <span style="float: right;">916x1050 2+ A.6P.aK</span></p> <div style="text-align: center;">  </div>	1		

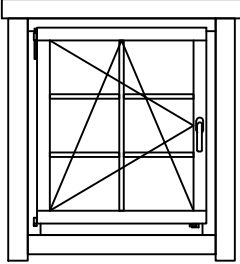
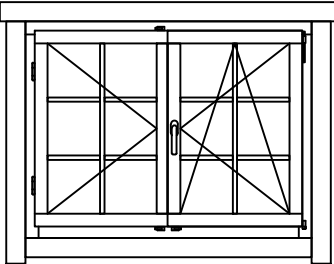
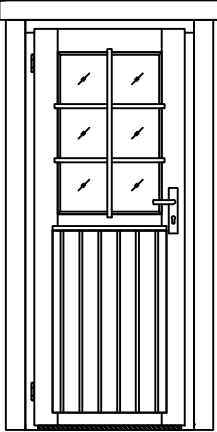
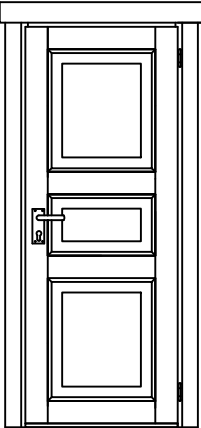
Pos	<p style="text-align: center;">Han 70, Art.No.7010441            Piece list - Stückliste - Liste des pièces - Elementi - Stuklijst - Tükítabel</p>	Q	P (mm)	L (mm)
	<p>Window - Fenster - Fenetre - Finestra - Raam - Aken <span style="float: right;">916x1050 2+ A.6V.aK</span></p> 	3		
	<p>Window - Fenster - Fenetre - Finestra - Raam - Aken <span style="float: right;">1374x1050 2+ TA.6P.aK</span></p> 	2		
	<p>Door - Tür - Porte - Porte - Deur - Uks <span style="float: right;">827x2000 2+ U.26V.bK</span></p> 	1		
	<p>Door - Tür - Porte - Porte - Deur - Uks <span style="float: right;">827x2000 U.3TP.a</span></p> 	2		



