

Han 70

Art.No. 7010441

Toughened glass - Verstärktes Glas - Verre trempé

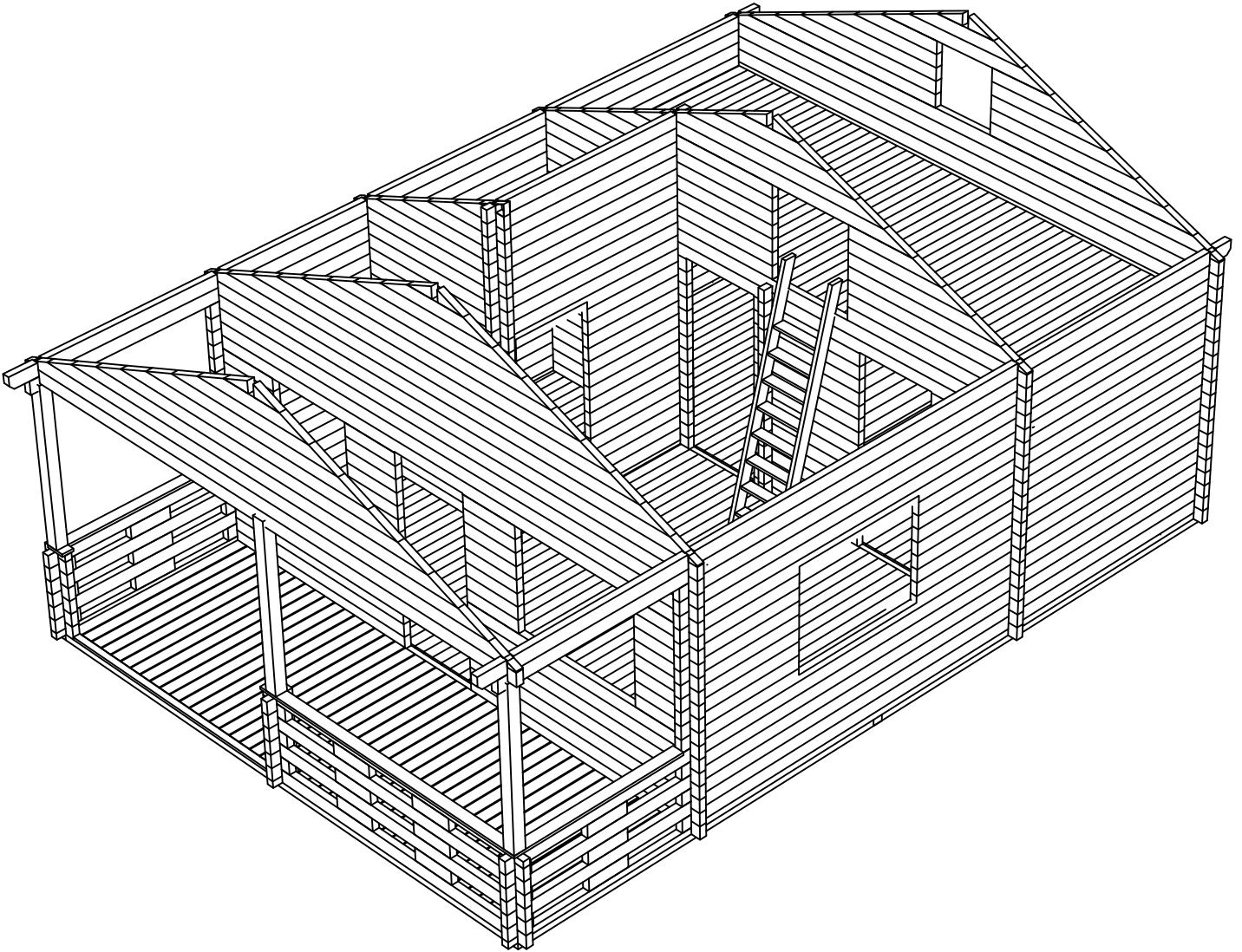

HAN 70, Art.No.7010441 (Toughened glass - Verstärktes Glas - Verre trempé)
GROUNDPLAN - GRUNDPLAN - PLAN DE MASSE

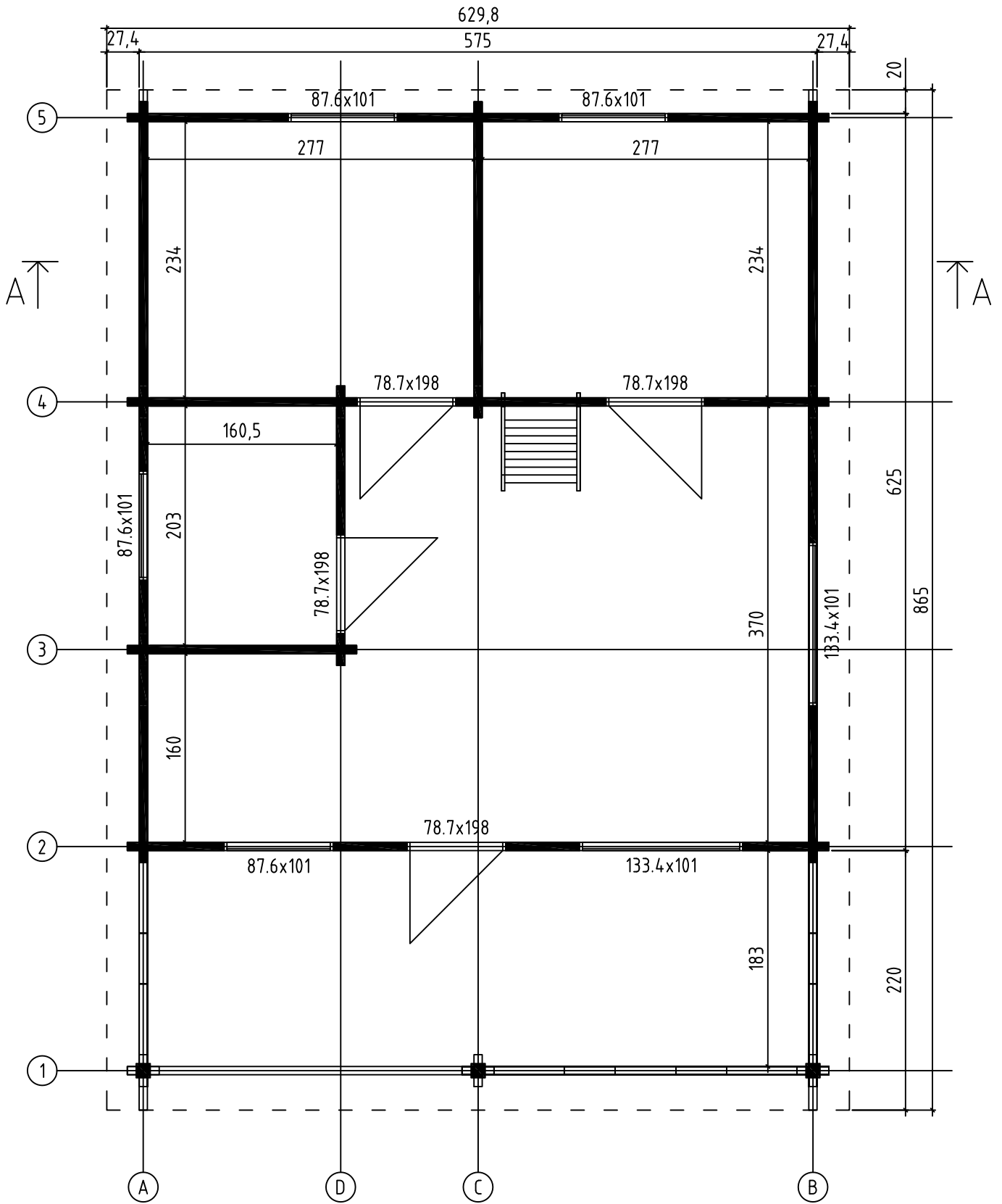

HAN 70, Art.No.7010441 (Toughened glass - Verstärktes Glas - Verre trempé)
GROUNDPLAN - GRUNDPLAN - PLAN DE MASSE

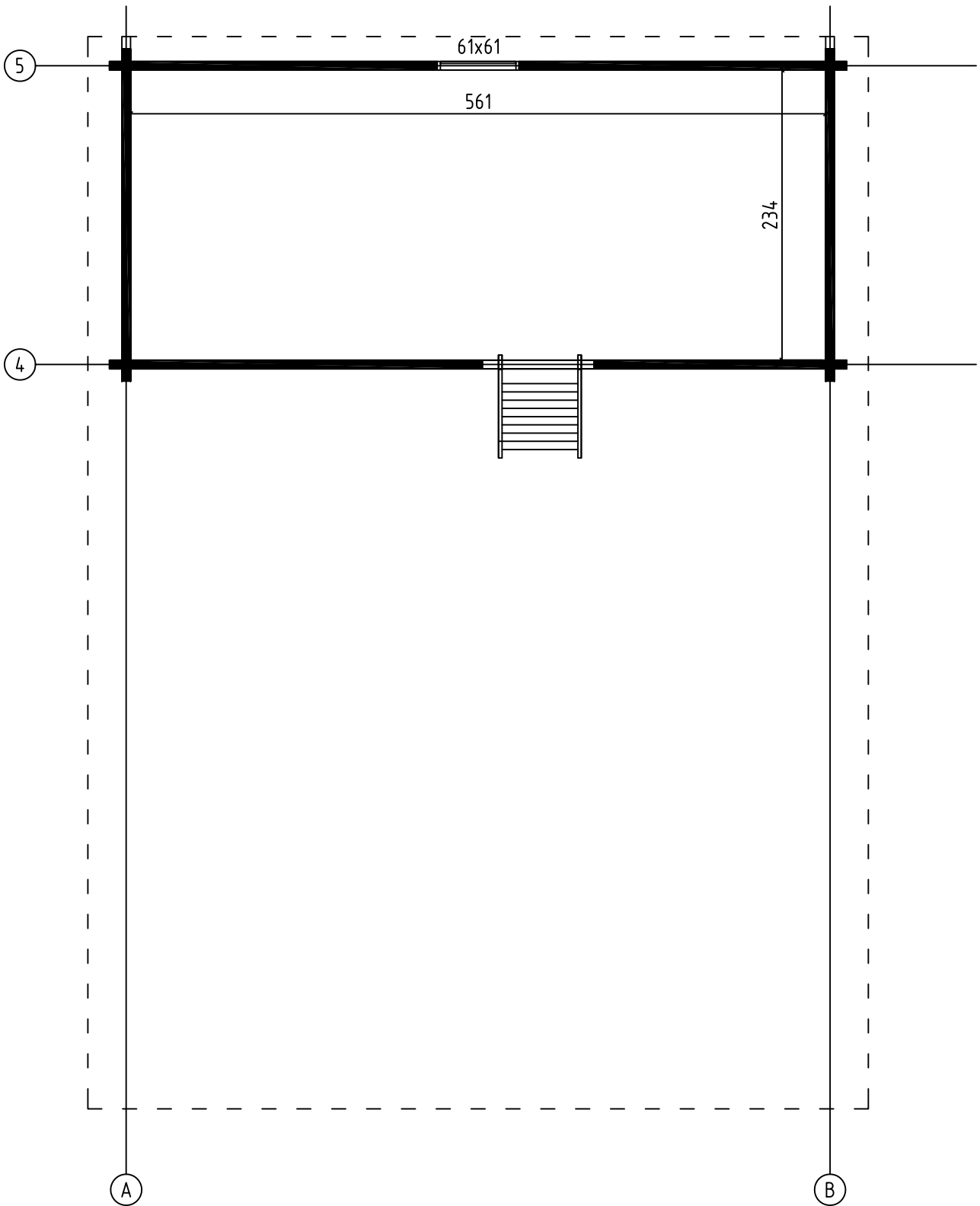

HAN 70, Art.No.7010441 (Toughened glass - Verstärktes Glas - Verre trempé)
 FOUNDATION - FUNDAMENT - FONDATION

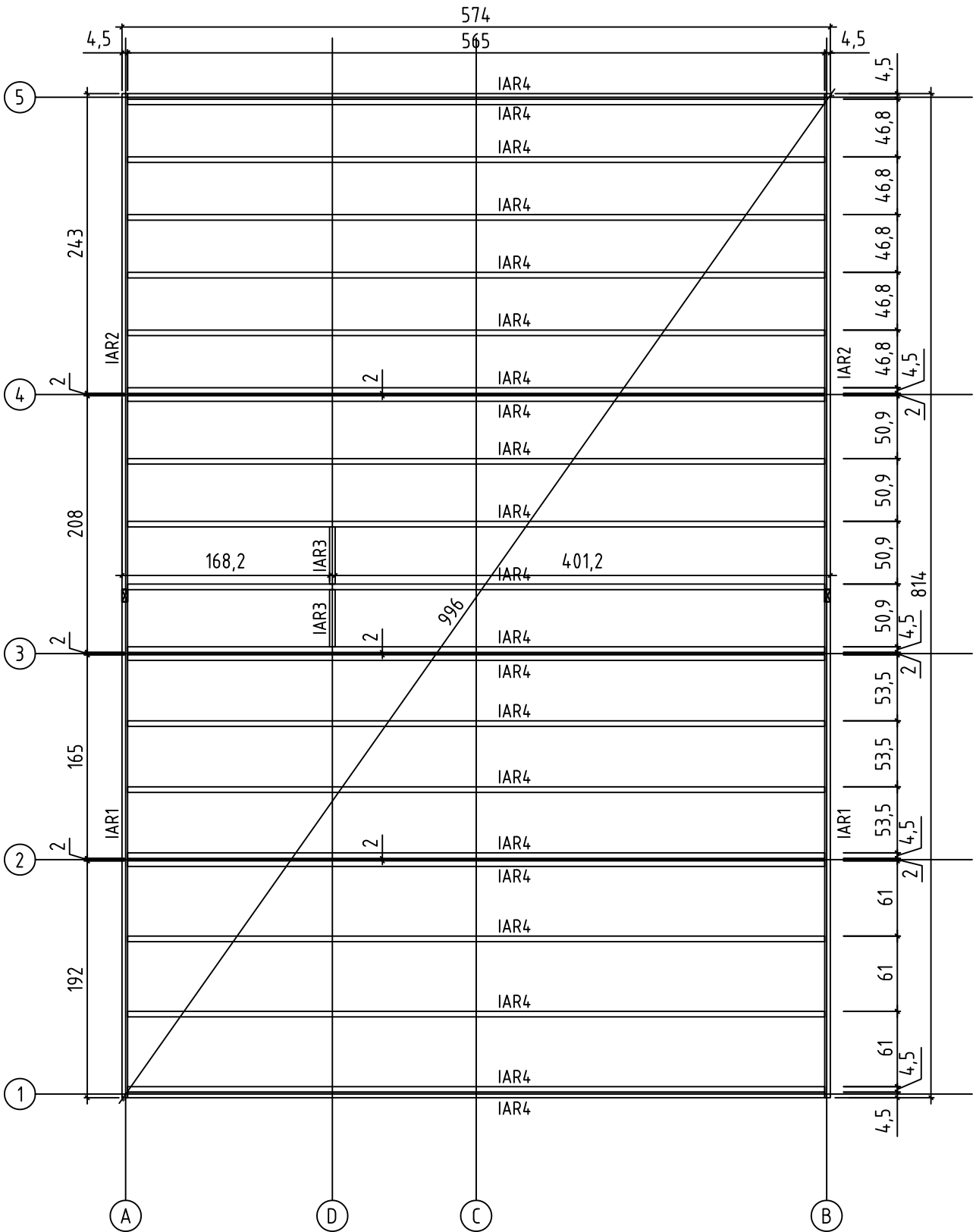

HAN 70, Art.No.7010441 (Toughened glass - Verstärktes Glas - Verre trempé)
MEZZANINE FLOOR JOISTS - HALBGESCHOSS BALKEN - SOLIVES DE PLANCHER MEZZANINE

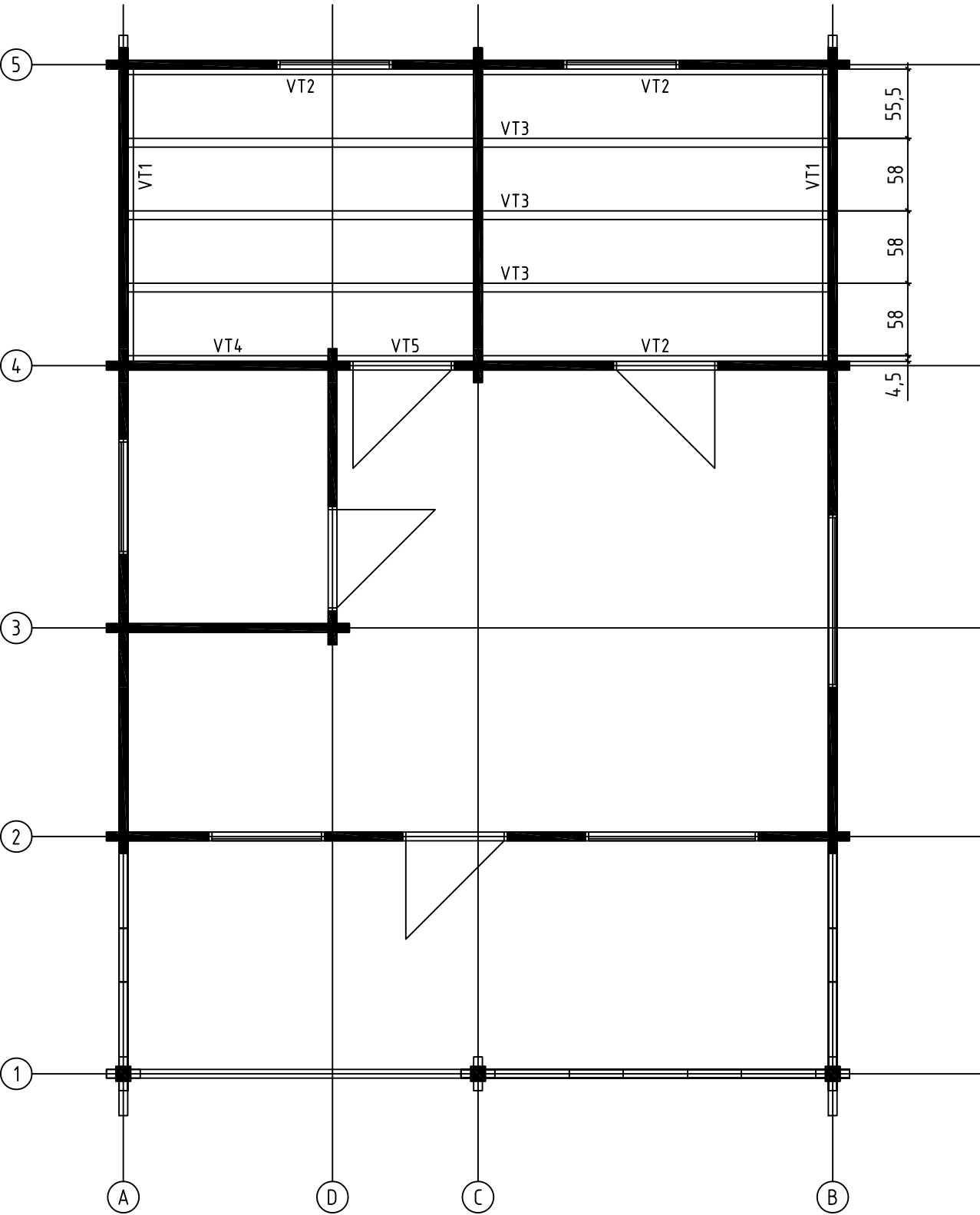

HAN 70, Art.No.7010441 (Toughened glass - Verstärktes Glas - Verre trempé)
FLOOR BOARDS - FUSSBODENBRETTER - PLAN POSE PLANCHER

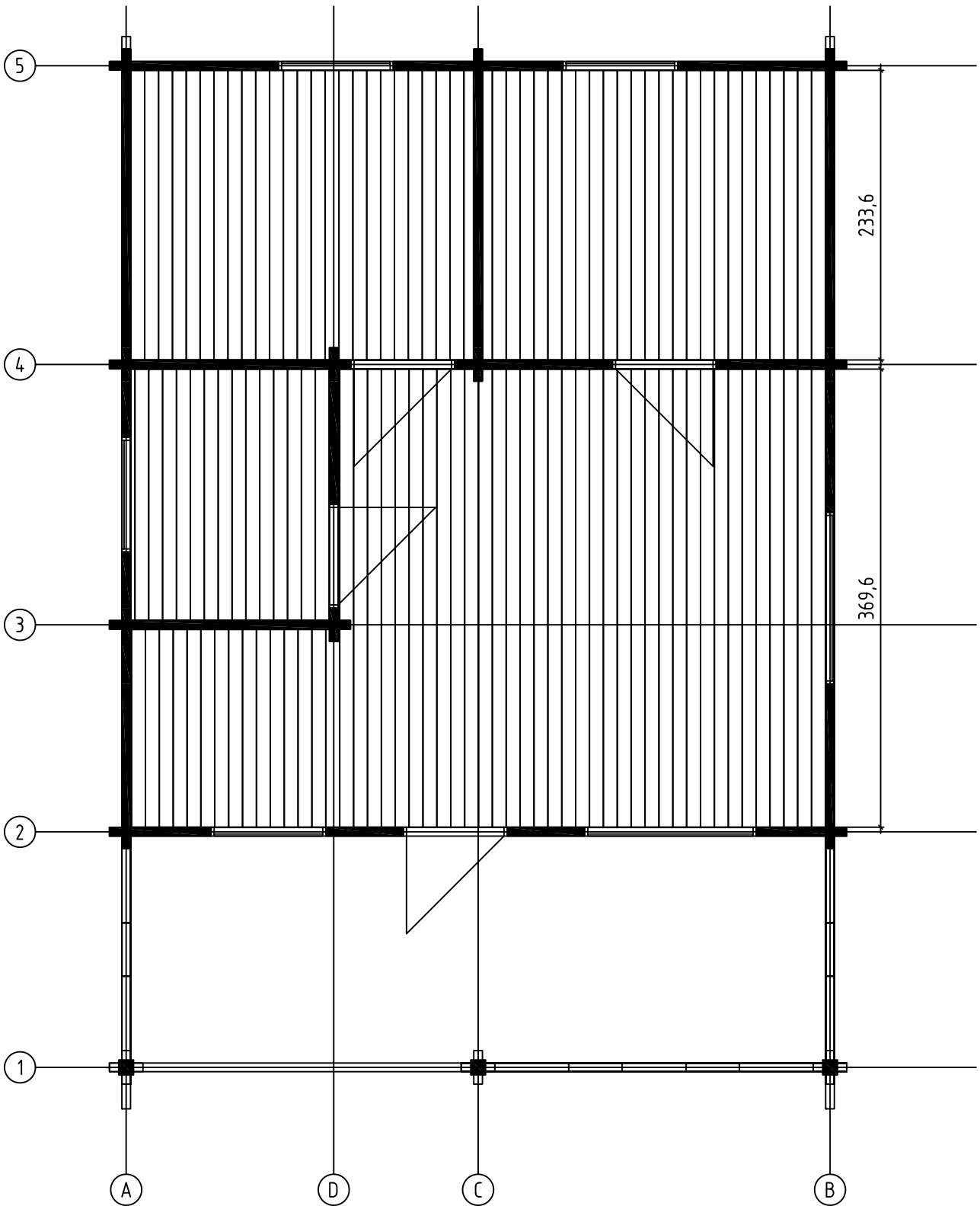

HAN 70, Art.No.7010441 (Toughened glass - Verstärktes Glas - Verre trempé)
FLOOR BOARDS - FUSSBODENBRETTER - PLAN POSE PLANCHER

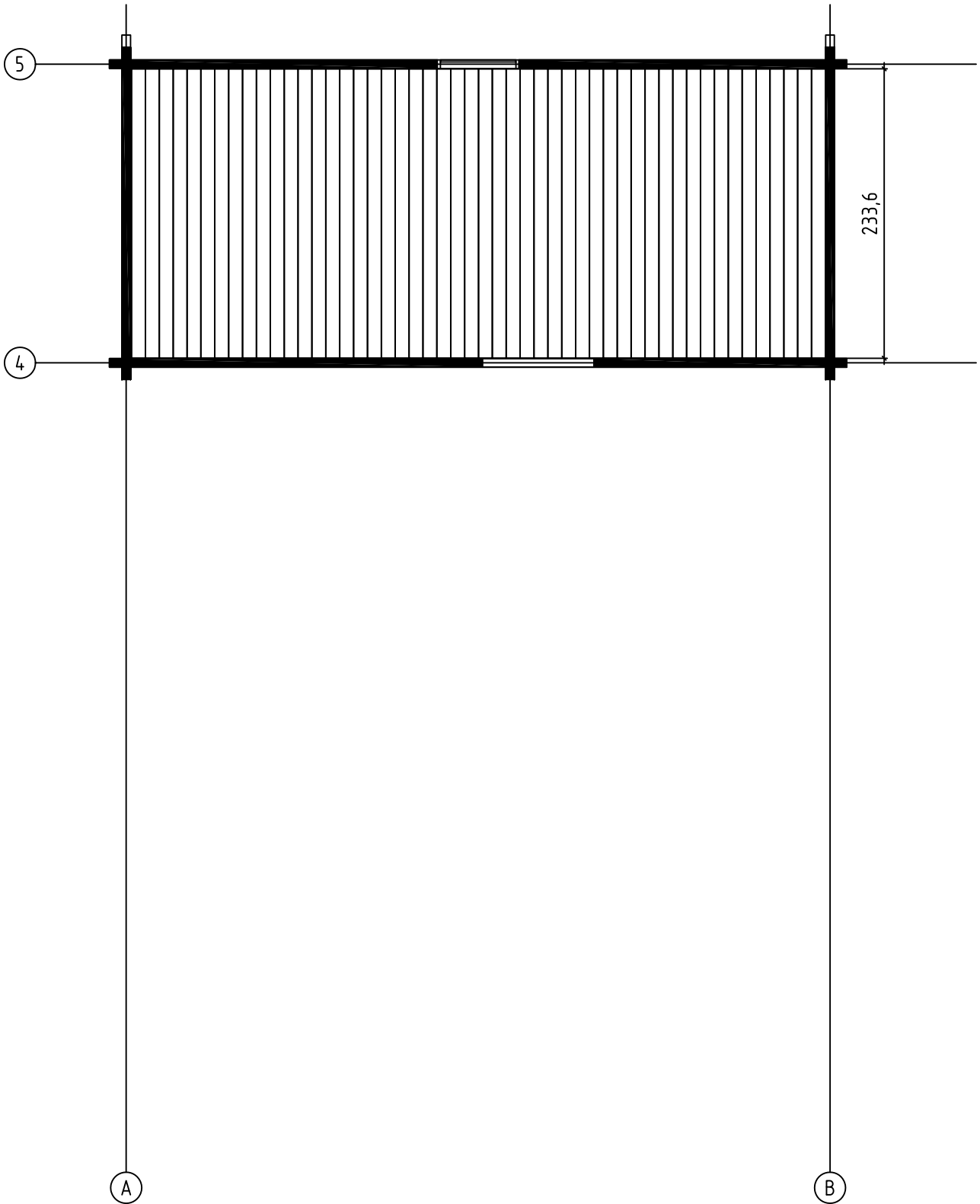

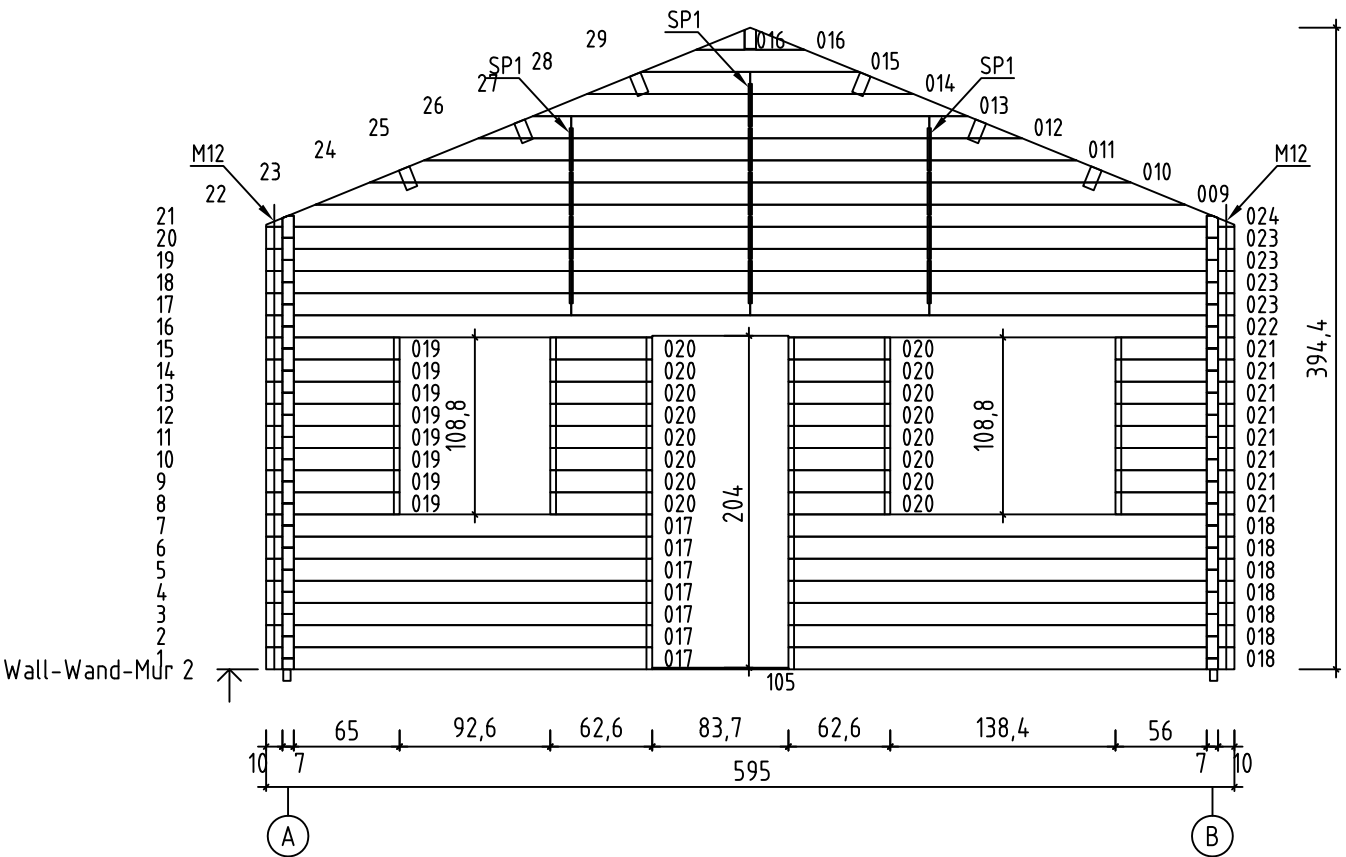
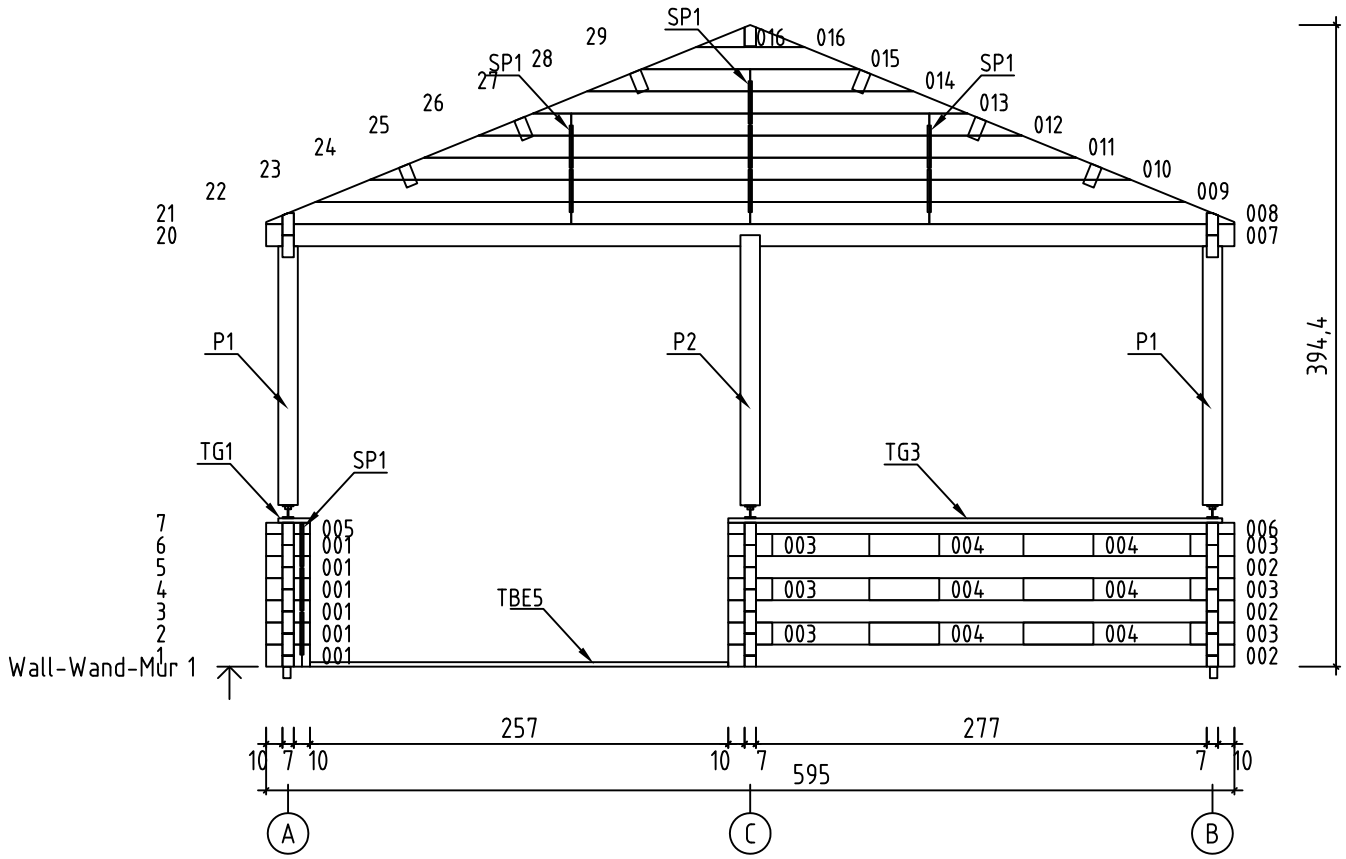

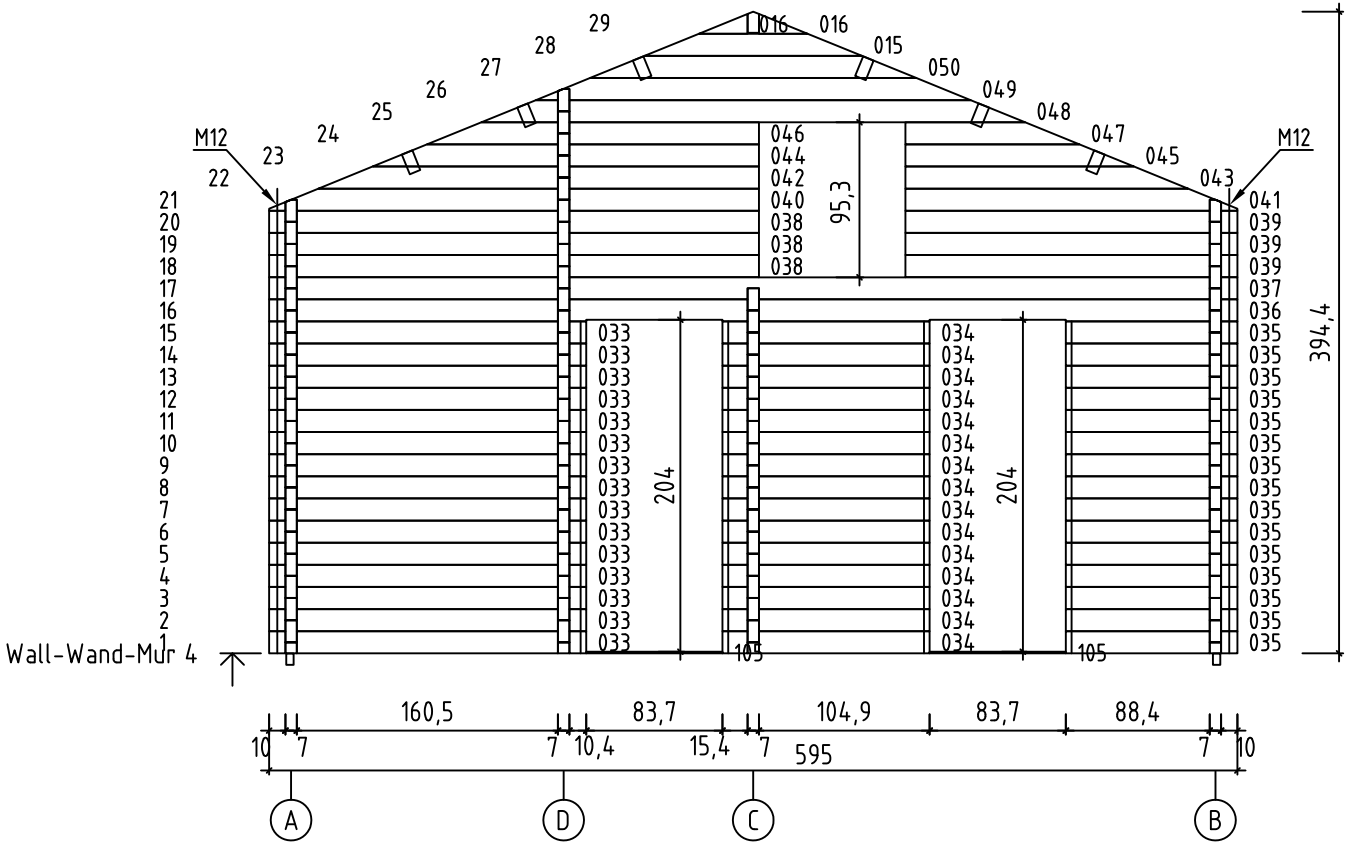
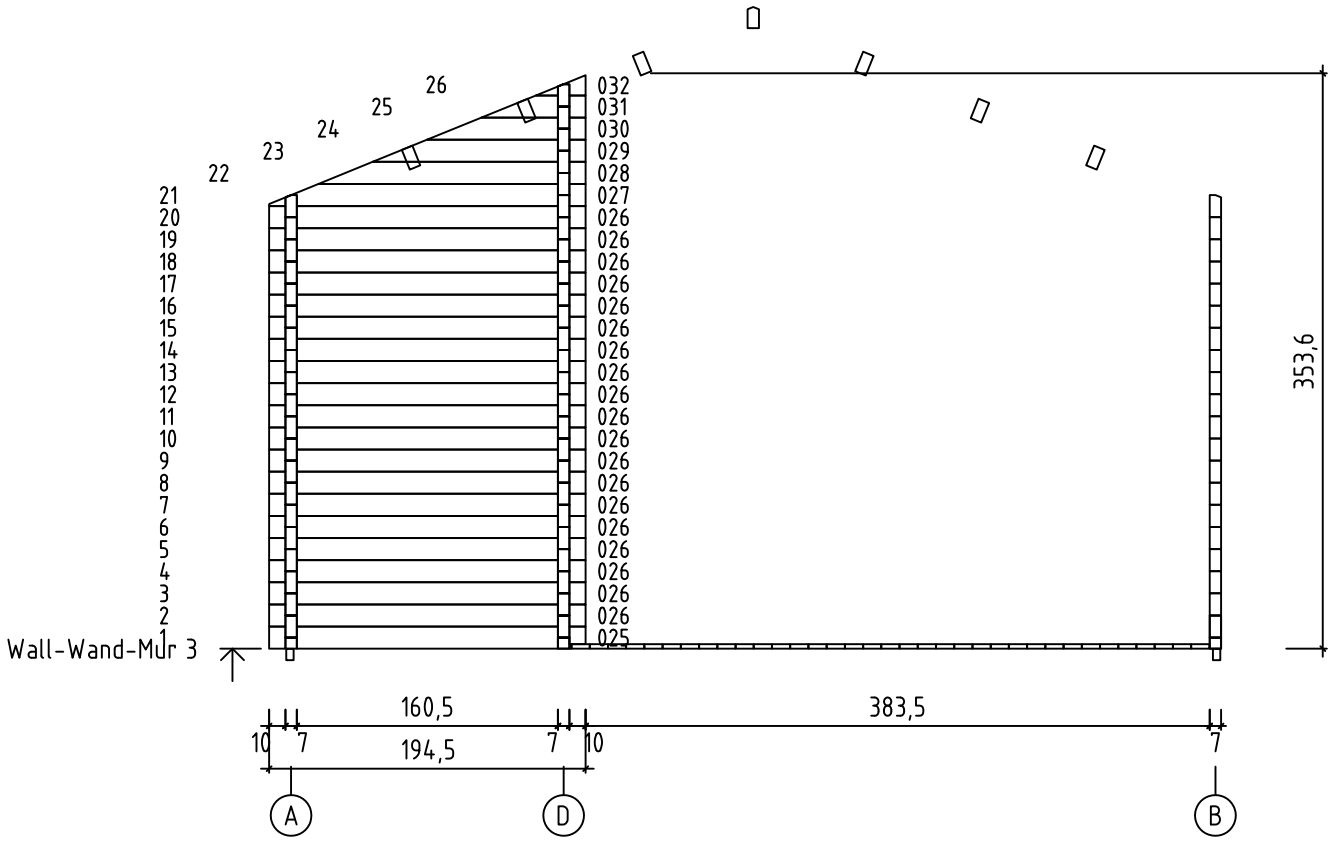

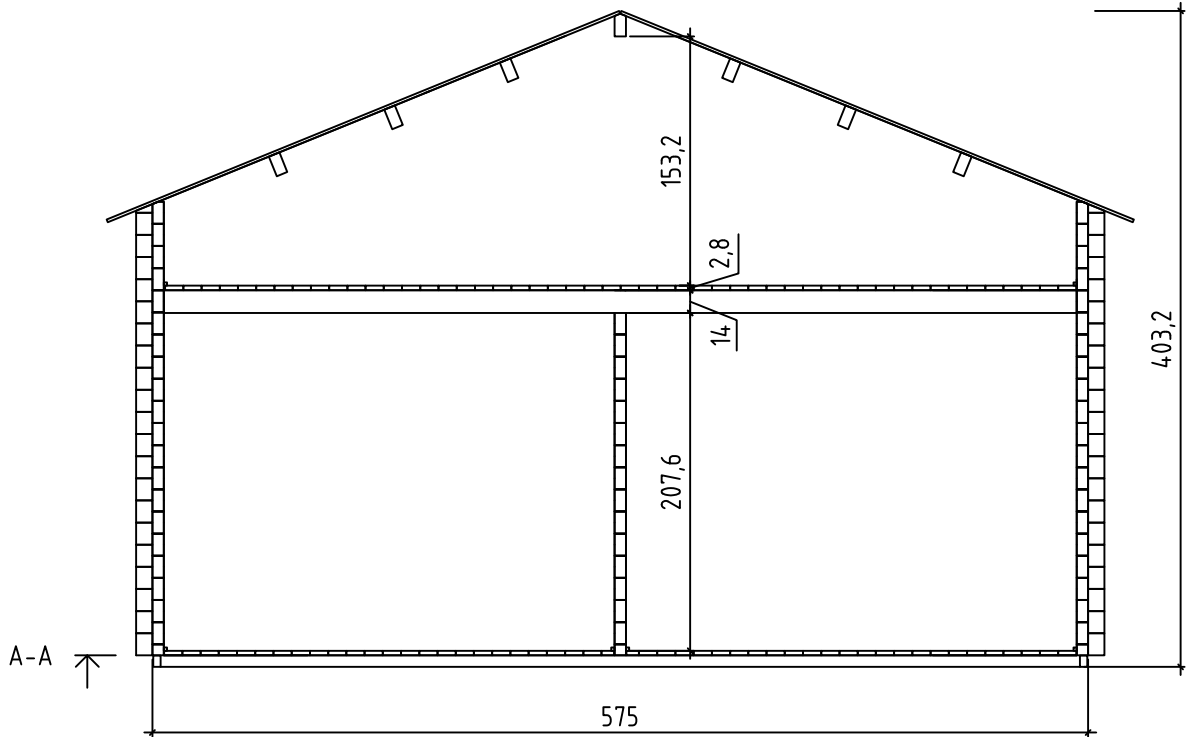
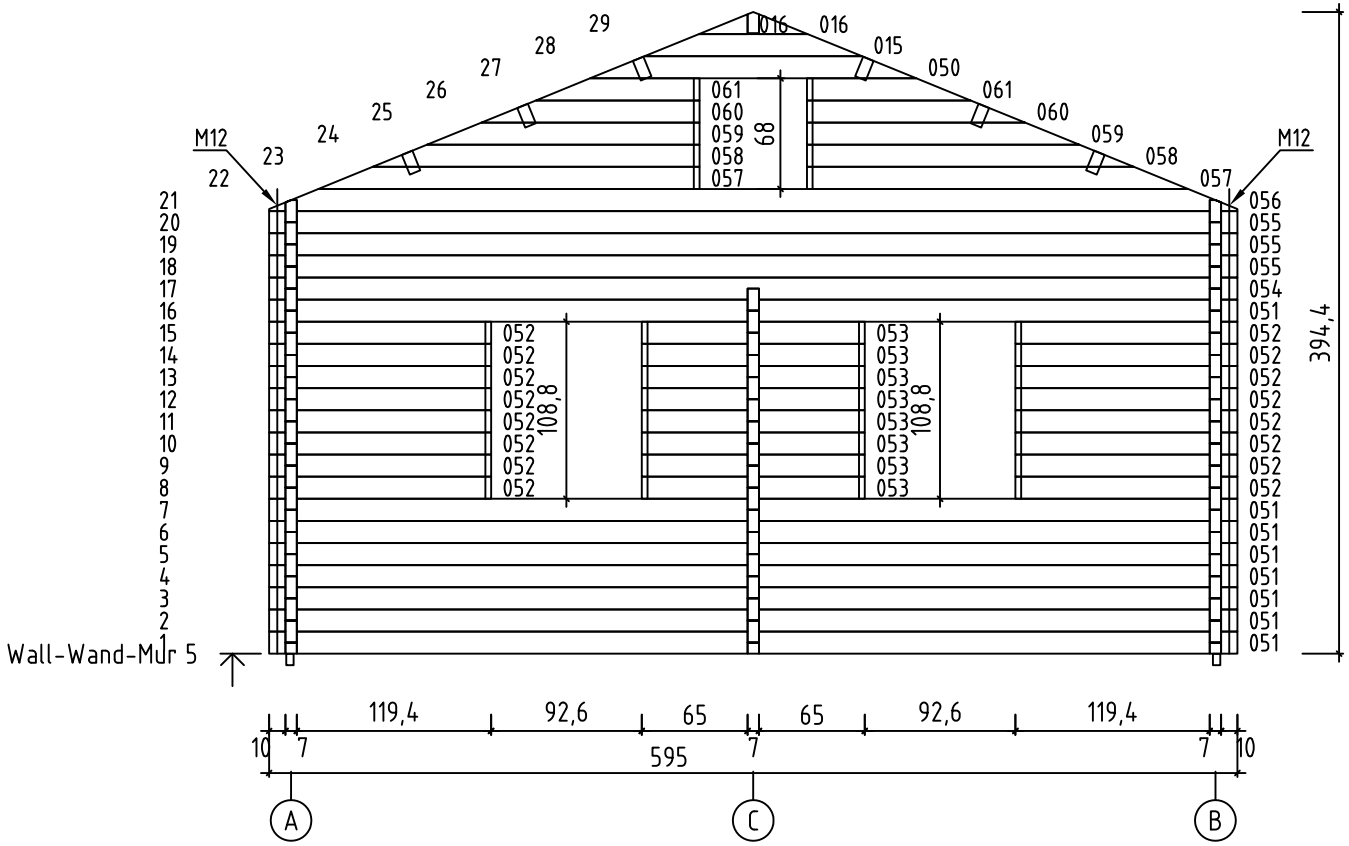



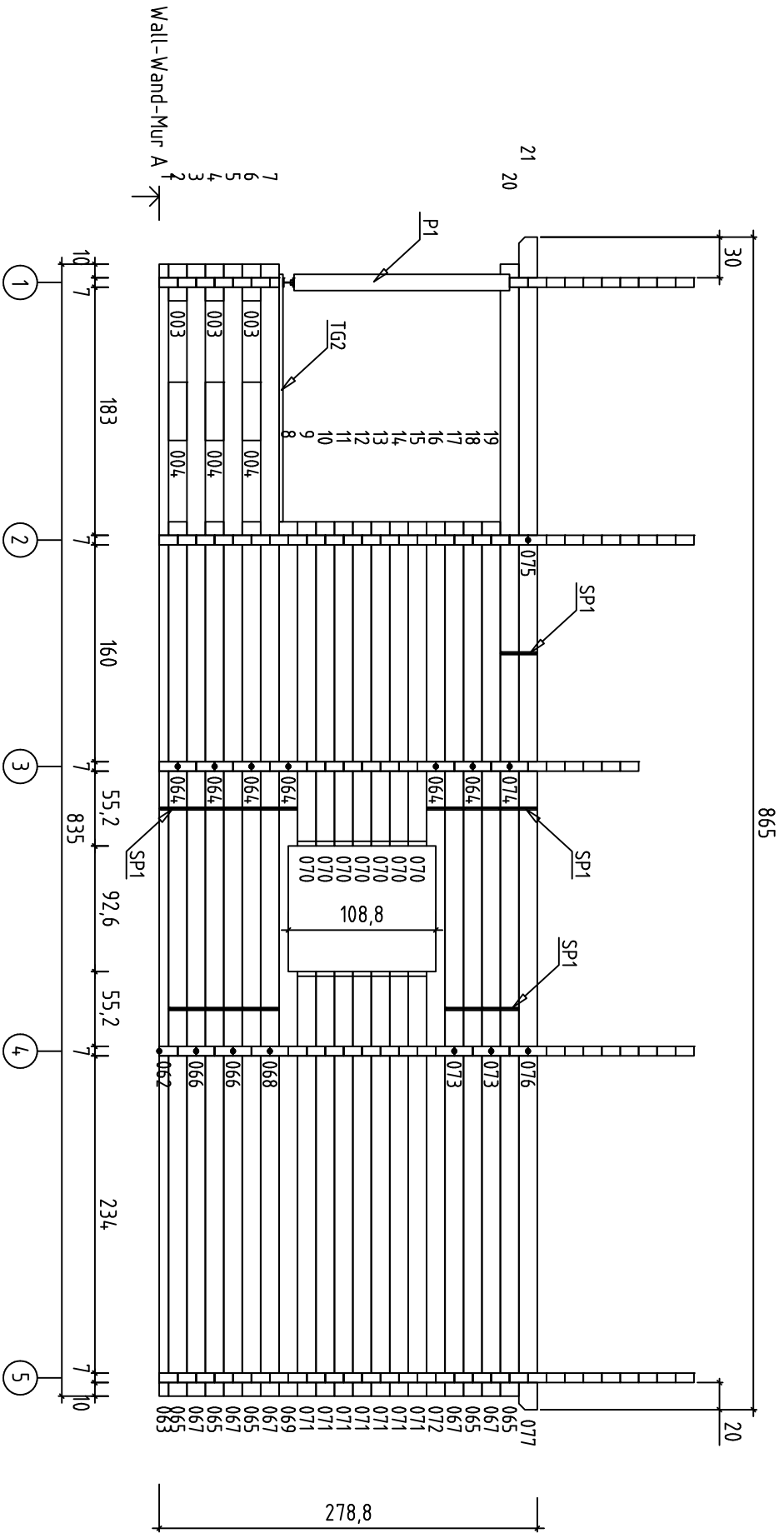



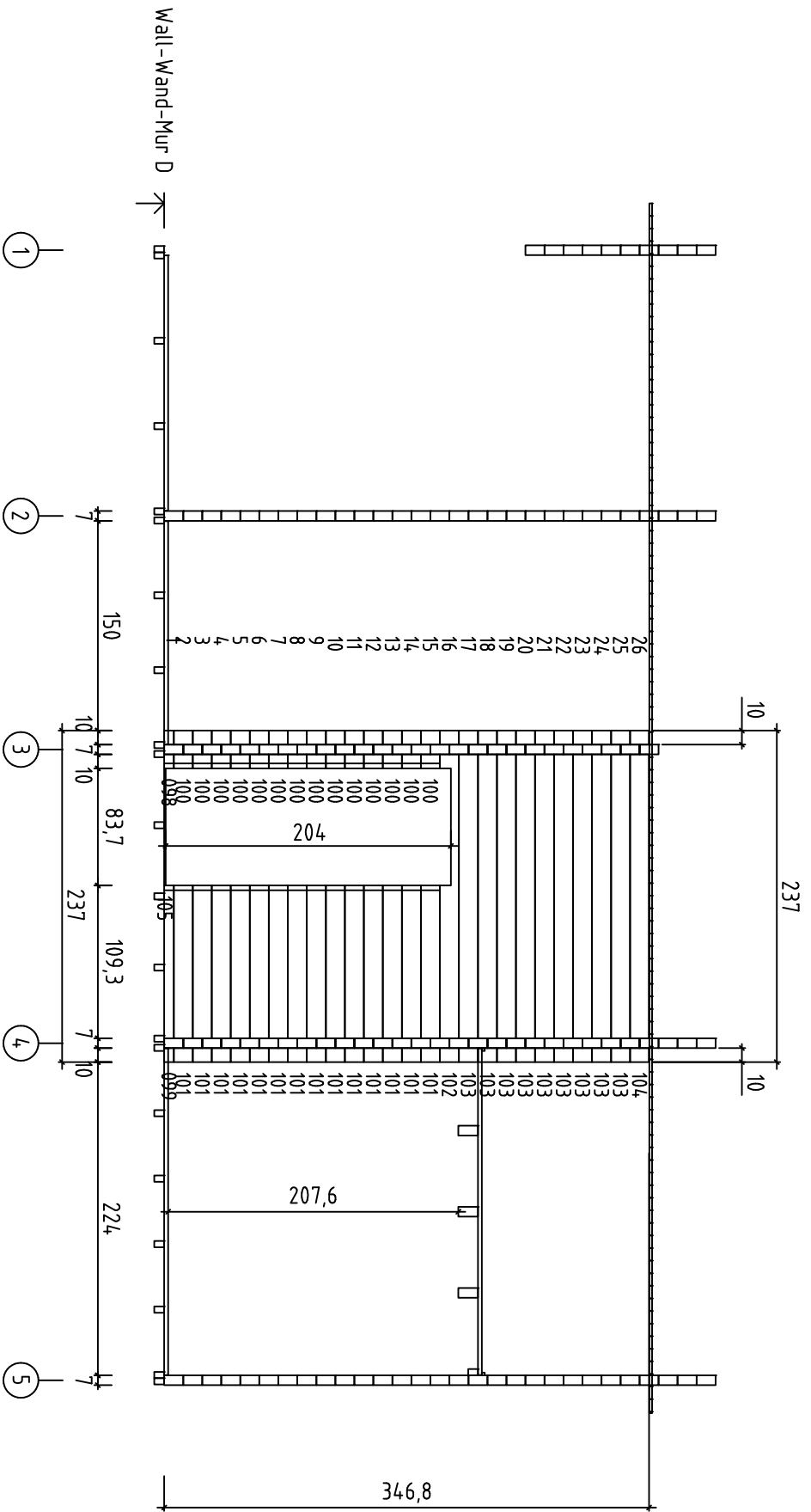



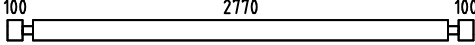

HAN 70, Art.No.7010441 (Toughened glass - Verstärktes Glas - Verre trempé)

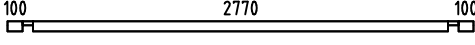
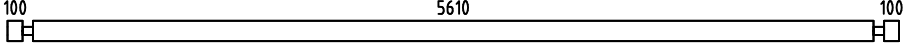
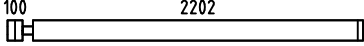
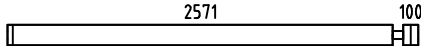
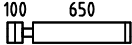
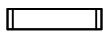
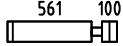
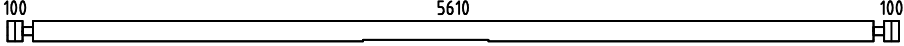
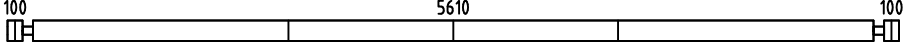
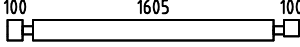
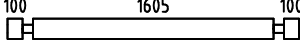
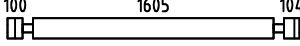
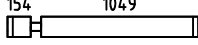
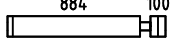
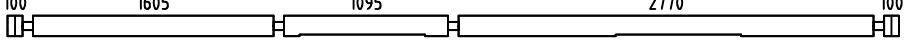
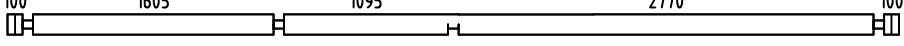
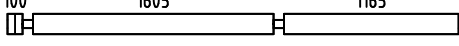
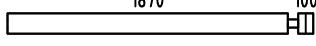
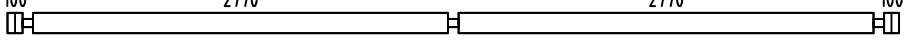
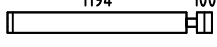

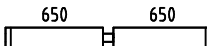
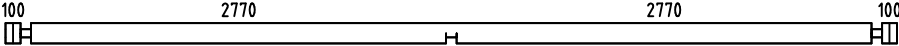
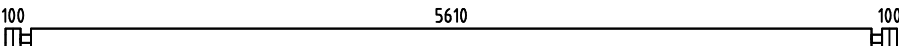
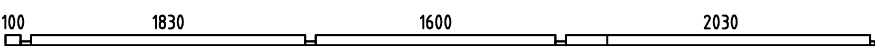
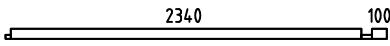
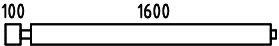
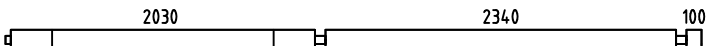
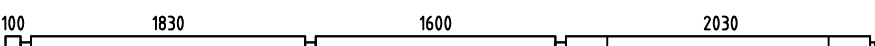
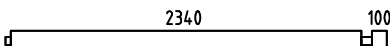
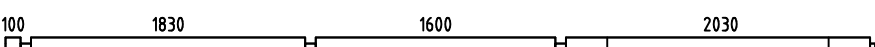

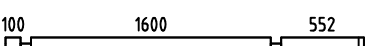
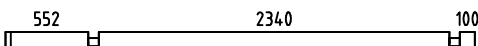

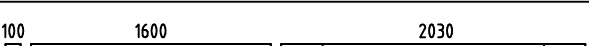
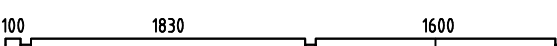
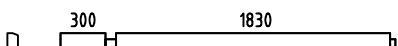

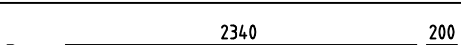
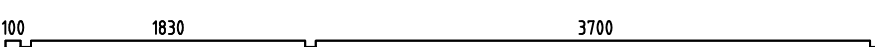
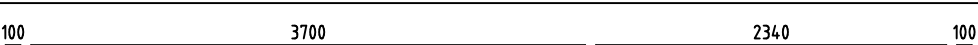
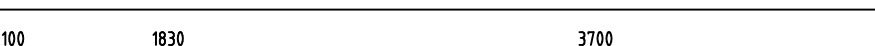
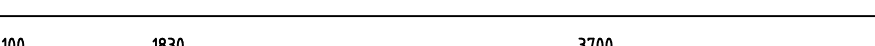
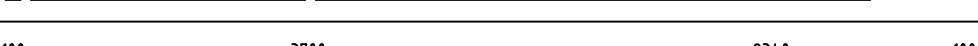
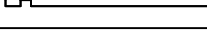

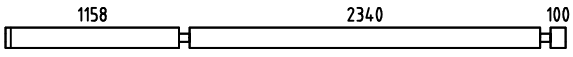
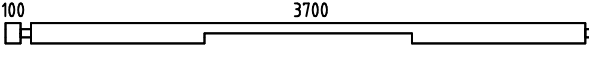
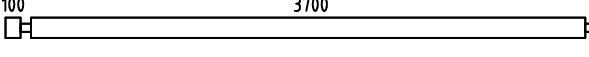
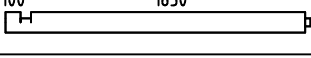
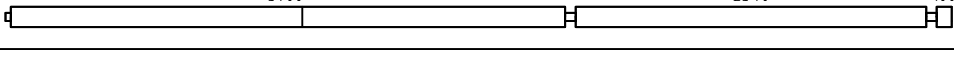
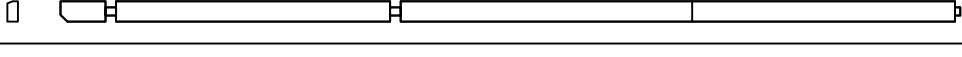
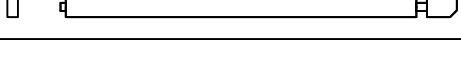

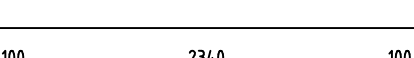
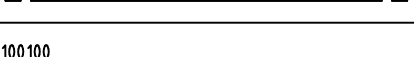
HAN 70, Art.No.7010441 (Toughened glass - Verstärktes Glas - Verre trempé)

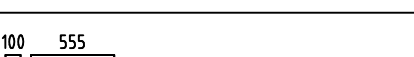
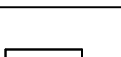



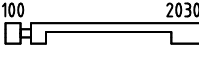
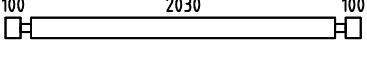
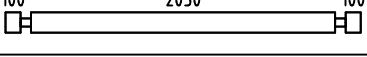
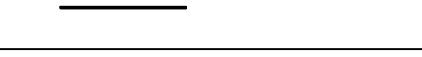

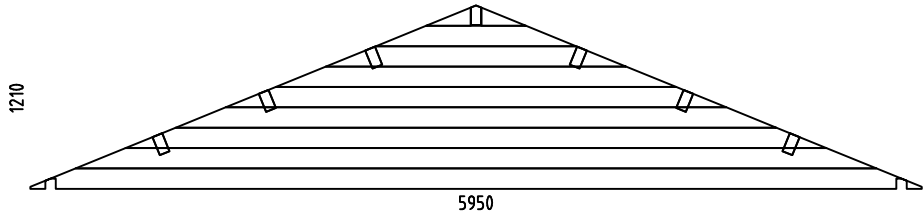











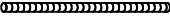
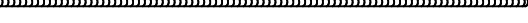







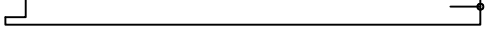
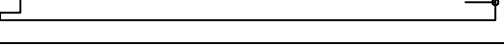
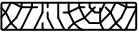







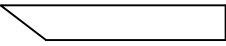
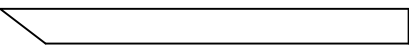
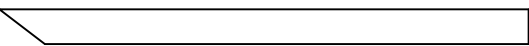
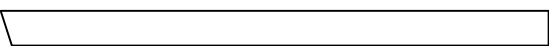



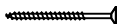
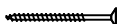



Pos	HAN 70, Art.No.7010441 (Toughened glass - Verstärktes Glas - Verre trempé) Piece list - Stückliste - Liste des pieces	Q.	P (mm)	L (mm)
001		11	70x136	270
002		3	70x136	3110
003		12	70x136	270
004		12	70x136	430
005		1	70x68	270
006		1	70x68	3110
007		1	70x136	5950
017		7	70x136	2372
018		7	70x136	2741
019		8	70x136	820
020		16	70x136	626
021		8	70x136	730
022		1	70x136	5950
023		4	70x136	5950
025		1	70x136	1945
026		19	70x136	1945
033		15	70x136	1949
034		15	70x136	1273
035		15	70x136	1054
036		1	70x136	5950
037		1	70x136	5950
038		3	70x136	3010
039		3	70x136	2040
051		8	70x136	5950
052		16	70x136	1364







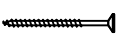

Pos	HAN 70, Art.No.7010441 (Toughened glass - Verstärktes Glas - Verre trempé) Piece list - Stückliste - Liste des pieces	Q.	P (mm)	L (mm)
053		8	70x136	1370
054		1	70x136	5950
055		3	70x136	5950
062		1	70x68	5805
063		2	70x68	2545
064		6	70x136	1805
065		5	70x136	4645
066		2	70x136	5805
067		10	70x136	2545
068		1	70x136	5805
069		1	70x136	4645
070		7	70x136	2392
071		7	70x136	3132
072		1	70x136	4645
073		2	70x136	3905
074		1	70x136	3705
075		1	70x136	2235
076		1	70x136	3770
077		1	70x136	2645
078		1	70x68	5805
079		5	70x136	6450
080		2	70x136	5805
081		1	70x136	5805
082		1	70x136	6450
083		7	70x136	1328

Pos	HAN 70, Art.No.7010441 (Toughened glass - Verstärktes Glas - Verre trempé) Piece list - Stückliste - Liste des pieces	Q.	P (mm)	L (mm)
084		7	70x136	3738
085		1	70x136	3905
086		1	70x136	3905
087		1	70x136	2035
088		1	70x136	6315
089		1	70x136	6005
090		1	70x136	2645
091		1	70x68	270
092		1	70x68	2680
093		14	70x136	2680
094		1	70x136	270
095		1	70x136	2680
096		2	70x136	725
097		2	70x136	510
098		1	70x68	270
099		1	70x68	1263
100		14	70x136	270
101		14	70x136	1263
102		1	70x136	2370
103		9	70x136	2370
104		1	70x136	2370
105		4	70x10	837
W1-1		1		

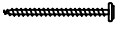
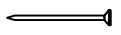
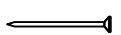
Pos	HAN 70, Art.No.7010441 (Toughened glass - Verstärktes Glas - Verre trempé) Piece list - Stückliste - Liste des pieces	Q.	P (mm)	L (mm)
W2-1		1		
W3-1		1		
W4-1		1		
W5-1		1		
IAR4	FOUNDATION - FUNDAMENT - FONDATION 	21	45x70	5650
IAR1	FOUNDATION - FUNDAMENT - FONDATION 	2	45x70	4120
IAR2	FOUNDATION - FUNDAMENT - FONDATION 	2	45x70	4120
IAR3	FOUNDATION - FUNDAMENT - FONDATION 	2	45x70	464
VT3	MEZZANINE FLOOR JOISTS -HALBGESCHOSS BALKEN - SOLIVES DE PLANCHER MEZZANINE 	3	70x140	5610
VT2	MEZZANINE FLOOR JOISTS -HALBGESCHOSS BALKEN - SOLIVES DE PLANCHER MEZZANINE 	3	45x70	2770
VT1	MEZZANINE FLOOR JOISTS -HALBGESCHOSS BALKEN - SOLIVES DE PLANCHER MEZZANINE 	2	45x70	2340
VT4	MEZZANINE FLOOR JOISTS -HALBGESCHOSS BALKEN - SOLIVES DE PLANCHER MEZZANINE 	1	45x70	1605
VT5	MEZZANINE FLOOR JOISTS -HALBGESCHOSS BALKEN - SOLIVES DE PLANCHER MEZZANINE 	1	45x70	1095
PR1	ROOF BEAM - DACHBALKEN - PANNE DE TOIT 	1	70x140	6080
PR2	ROOF BEAM - DACHBALKEN - PANNE DE TOIT 	1	70x140	2720
PR23	ROOF BEAM - DACHBALKEN - PANNE DE TOIT 	4	70x140	6080
PR21	ROOF BEAM - DACHBALKEN - PANNE DE TOIT 	2	70x140	6080
PR22	ROOF BEAM - DACHBALKEN - PANNE DE TOIT 	6	70x140	2720

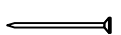
Pos	HAN 70, Art.No.7010441 (Toughened glass - Verstärktes Glas - Verre trempé) Piece list - Stückliste - Liste des pieces	Q.	P (mm)	L (mm)
PTL	FLOOR BOARDS - FUSSBODENBRETTER - LAME DE PLANCHER 	36	112x28	3696
PTL	FLOOR BOARDS - FUSSBODENBRETTER - LAME DE PLANCHER 	101	112x28	2336
PTL	FLOOR BOARDS - FUSSBODENBRETTER - LAME DE PLANCHER 	15	112x28	2026
PTL	FLOOR BOARDS - FUSSBODENBRETTER - LAME DE PLANCHER 	15	112x28	1596
	ROOF BOARDS - DACHBRETTER - VOLIGES 	194	90x18	3400
SV2	TERRACE BOARDS - TERRASSENBRETTER - PLANCHER DE TERRASSE 	44	120x28	1826
	FLOOR FILLET-FUSSBODENLEISTE - CORNIERE DE FINITION DU PLANCHER 		18x18	62.1 m.
TBE5	TERRACE EDGE BOARD - TERRASSENBRETT, EINGANG - LAME DE SEUIL D'ENTREE DE TERRASSE 	1	28x70	2570
DPL	ROOFING FELT FILLET - DACHPAPPENLEISTE - BAGUETTE DE FIXATION DU FEUTRE BITUMEUX 	4	18x58	3450
M12	TREADED ROD M12 - GEWINDESTANGE M12 - TIGE FILETÉE M12 	6		785
M12	TREADED ROD M12 - GEWINDESTANGE M12 TIGE FILETÉE M12 	6		2000
LPL	FIXING FILLET - FIXIRUNGSLEISTE - PROFIL DE FIXATION 	2	20x70	610
LPL	FIXING FILLET - FIXIRUNGSLEISTE - PROFIL DE FIXATION 	2	20x70	650
LPL	FIXING FILLET - FIXIRUNGSLEISTE - PROFIL DE FIXATION 	4	20x70	787
LPL	FIXING FILLET - FIXIRUNGSLEISTE - PROFIL DE FIXATION 	8	20x70	876
LPL	FIXING FILLET - FIXIRUNGSLEISTE - PROFIL DE FIXATION 	12	20x70	1050
LPL	FIXING FILLET - FIXIRUNGSLEISTE - PROFIL DE FIXATION 	4	20x70	1334
LPL	FIXING FILLET - FIXIRUNGSLEISTE - PROFIL DE FIXATION 	8	20x70	2000
P1	POST - PFOSTEN - POTEAU 	2	120x120	1592
P2	POST - PFOSTEN - POTEAU 	1	120x120	1660
TB	EAVES BOARD - TRAUFBRETT - BANDEAU DE TOIT 	4	18x90	4325
DRV	ROOF EDGE REINFORCEMENT - DACHRANDVERSTÄRKUNG - CORNIERE DE RENFORT DE BORD DE TOIT 	4	28x34	4325
TBE6	FIXING FILLET FOR WINDOW - FIXIRUNGSLEISTE FÜR FENSTER - PROFIL DE FIXATION DES FENETRES 	2	28x34	650
TBE6	FIXING FILLET FOR WINDOW - FIXIRUNGSLEISTE FÜR FENSTER - PROFIL DE FIXATION DES FENETRES 	4	28x34	884
TBE6	FIXING FILLET FOR WINDOW - FIXIRUNGSLEISTE FÜR FENSTER - PROFIL DE FIXATION DES FENETRES 	8	28x34	1050

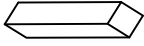
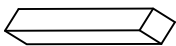
Pos	HAN 70, Art.No.7010441 (Toughened glass - Verstärktes Glas - Verre trempé) Piece list - Stückliste - Liste des pieces	Q.	P (mm)	L (mm)
TBE6	FIXING FILLET FOR DOOR - FIXIRUNGSLEISTE FÜR TÜR - PROFIL DE FIXATION DES PORTES 	2	28x34	1894
TBE6	FIXING FILLET FOR DOOR - FIXIRUNGSLEISTE FÜR TÜR - PROFIL DE FIXATION DES PORTES 	6	28x34	1990
TG1	GUARD-RAIL FOR TERRACE - TERRASSEN- GELÄNDER - MAIN COURANTE DE TERRASSE 	1	28x120	195
TG2	GUARD-RAIL FOR TERRACE - TERRASSEN- GELÄNDER - MAIN COURANTE DE TERRASSE 	1+1	28x120	1825
TG3	GUARD-RAIL FOR TERRACE - TERRASSEN- GELÄNDER - MAIN COURANTE DE TERRASSE 	1	28x120	3035
GL	GABLE MOULDING - GIEBELLEISTE PLANCHE DE RIVE 	4	18x120	3450
KL4	LENGTHENING BOLT FOR TREADED ROD - VERLÄNGERUNGSMUTTER FÜR GEWINDESTANGE - MANCHON DE RACCORDEMENT DE TIGE FILETÉE 	6		
KL1	DRIVE NUT TREADED ROD - EINSHLAGMUTTER FÜR GEWINDESTANGE - ÉCROU A FRAPPER POUR TIGE FILÉTÉE 	6		
KL2	NUT FOR TREADED ROD - MUTTER FÜR GEWINDESTANGE - ÉCROU POUR TIGE FILETÉE 	6		
KL3	PLAIN WASHER TREADED ROD - UNTERLEGSSCHEIBE FÜR GEWINDESTANGE - RONDELLE PLATE POUR TIGE FILETÉE 	6		
HS12	SCREW FOR GABLE SEGMENT - SCHRAUBEN FÜR DECKBLATT - VIS POUR FIXATION LOSANGE DE FINITION 	4	3.5x35	
HS83	SCREW FOR FIXING FILLET - SCHRAUBEN FÜR FIXIRUNGSLEISTE - VIS POUR PROFIL DE FIXATION 	156	3.5x50	
HS84	SCREW FOR FIXING FILLET - SCHRAUBEN FÜR FIXIRUNGSLEISTE - VIS POUR PROFIL DE FIXATION 	86	3.5x50	
HS16	SCREW FOR GABLE MOULDING - SCHRAUBEN FÜR GIEBELLEISTE - VIS DE FIXATION POUR PLANCHE DE RIVE 	40	3.5x50	
HS32	SCREW FOR EAVES BOARDS - SCHRAUBEN FÜR TRAUFBRETT - VIS DE FIXATION POUR BANDEAU DE TOIT 	40	4x40	
HS26	SCREW FOR ROOF EDGE REINFORCEMENT - SCHRAUBEN FÜR DACHRANDVERSTÄRKUNG - VIS POUR RENFORT DE BORD DE TOIT 	40	4x40	
HS34	SCREW FOR POST - SCHRAUBEN FÜR PFOSTEN - VIS DE FIXATION DES POTEAUX 	6	4x60	
HS36	SCREW FOR STEPLADDER - SCHRAUBE FÜR LEITER VIS D'ASSEMBLAGE DES MARCHES DE L'ECHELLE 	36	4x60	
HS30	SCREW FOR TERRACE REAR BOARDS - SCHRAUBEN FÜR TERRASSENRAND - VIS DE FIXATION POUR MAIN COURANTE DE TERRASSE 	17	4x60	
NF3	SCREW FOR TERRACE BOARD - SCHRAUBE FÜR TERRASSENBRETT VIS POUR LAME DE SEUIL D'ENTREE DE TERRASSE 	5	4x60	
HS86	SCREW FOR MEZZANINE FLOOR JOISTS - SCHRAUBEN FÜR HALBGESCHOSS BALKEN - VIS DE FIXATION SOLIVES DE PLANCHER MEZZANINE 	59	5x100	
HS40	SCREW FOR 1. WALL BEAM - SCHRAUBE FÜR 1. BOHLENREIHE VIS DE FIXATION DES FONDATIONS 	27	5x120	
HS42	SCREW FOR GABLE - SCHRAUBEN FÜR GIEBEL - VIS POUR FIXATION DES PIGNONS 	78	5x120	
HS43	SCREW FOR ROOF BEAMS - SCHRAUBEN FÜR DACHBALKEN VIS POUR PANNE DE TOIT 	44	5x120	
HS78	SCREW FOR Pos.096, 097 - SCHRAUBEN FÜR Pos.096, 097 VIS POUR Pos.096, 097 	5	5x120	

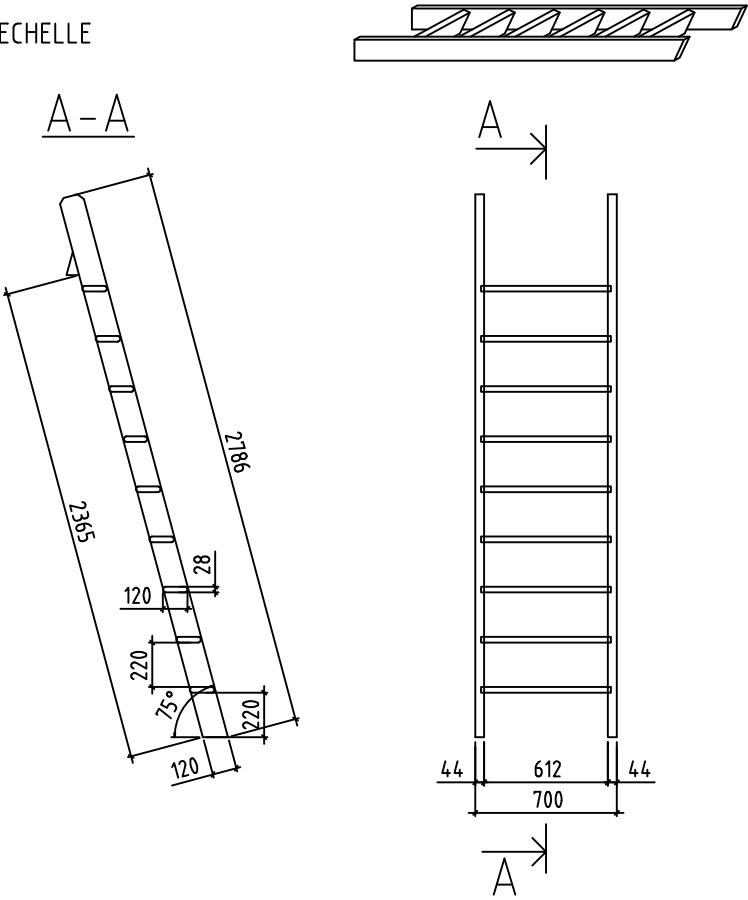
Pos	HAN 70, Art.No.7010441 (Toughened glass - Verstärktes Glas - Verre trempé) Piece list - Stückliste - Liste des pieces	Q.	P (mm)	L (mm)
HS39	SCREW FOR FUNDAMENT - SCHRAUBEN ZUR BEFESTIGUNG FUNDAMENT - VIS POUR FONDATION 	60	5x90	
HS49	SCREW FOR POST HEIGHT ADJUSTMENT - SCHRAUBEN FÜR REGULIERUNGSSCHRAUBE FÜR PFOSTEN - VIS DE FIXATION DE SUPPORT RÉGLABLE DE POTEAU 	24	6x50	
SH70	HAMMER BLOCK - SCHLAGHOLZ - CALLE DE FRAPPE 	2		
	SCREW FOR DOORSTEP - SCHRAUBEN FÜR TÜRSCHWELLE VIS DE FIXATION DU SEUIL DE PORTE 	8	4.5x65	
NFD	ZN NAIL FOR ROOFING FELT FILLET - ZN NÄGEL FÜR DACHPAPPENLEISTE - POINTE POUR BAGUETTE FIXATION FEUTRE BITUMEUX 	32	2x40	
NF3	ZN NAIL FOR TERRACE - ZN NÄGEL FÜR TERRASSENBRETTNER POINTE POUR PLANCHER DE TERRASSE 	352	2x50	
NFF	ZN NAIL FOR FILLETS - ZN NÄGEL FÜR LEISTEN - POINTE POUR CORNIERE 	125	1.4x40	
NF2	ZN NAIL FOR ROOF - ZN NÄGEL FÜR DACHBRETTNER - POINTE POUR TOIT 	1015	2x50	
NH1	ZN NAIL FOR FLOOR - ZN NÄGEL FÜR FUSSBODENBRETTNER - CLOUS POUR PLANCHER 	1050	2x50	
GS	GABLE SEGMENT-DECKBLATT - LOSANGE DE FINITION 	2		
SP2	HIDDEN FIXING - HOLZDÜBEL - TOURILLON BOIS 	1		
SP1	HIDDEN FIXING - HOLZDÜBEL - TOURILLON BOIS 	40		
RFP	POST HEIGHT ADJUSTMENT - REGULIERUNGSSCHRAUBE FÜR PFOSTEN - SUPPORT RÉGLABLE DE POTEAU 	3		
ORZ	MONTAGE SET FOR DOORS AND WINDOWS - MONTAGE-SET FÜR TÜREN UND FENSTER - JEU DE MONTAGE PORTES ET FENETRES	1		
LR	LADDER - LEITER - ECHELLE 	1		

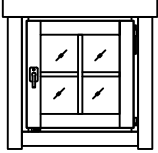
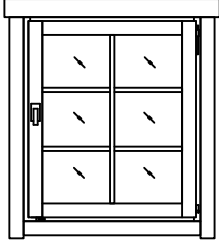
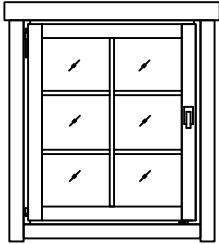
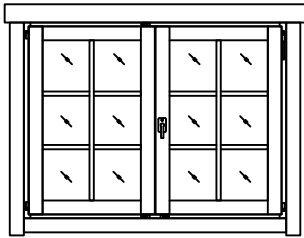
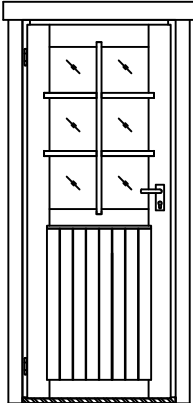
Pos	HAN 70, Art.No.7010441 (Toughened glass - Verstärktes Glas - Verre trempé) Piece list - Stückliste - Liste des pieces	Q.	P (mm)	L (mm)
2+ A.4P	WINDOW-FENSTER-FENETRE 650x650 Toughened glass - Verstärktes Glas - Verre trempé 	1		
2+ A.6P.a	WINDOW-FENSTER-FENETRE 916x1050 Toughened glass - Verstärktes Glas - Verre trempé 	1		
2+ A.6V.a	WINDOW-FENSTER-FENETRE 916x1050 Toughened glass - Verstärktes Glas - Verre trempé 	3		
2+ TA .6P.a	WINDOW-FENSTER-FENETRE 1374x1050 Toughened glass - Verstärktes Glas - Verre trempé 	2		
2+ U.26V.b	DOOR-TÜR-PORTE 827x2000 Toughened glass - Verstärktes Glas - Verre trempé 	1		

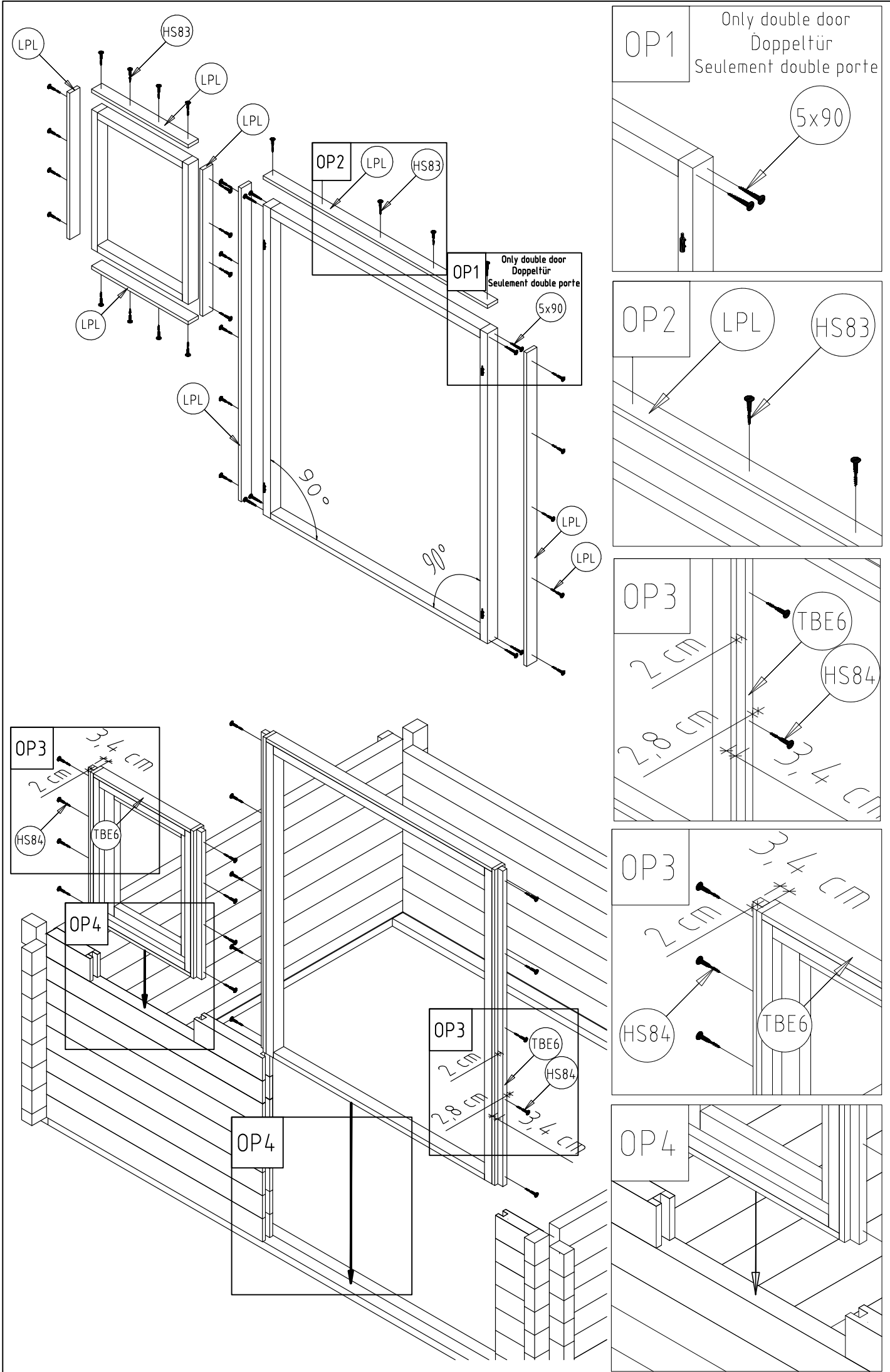

OP1 Only double door
Doppeltür
Seulement double porte

