

# Grossglockner 70

Art.No. 7011144

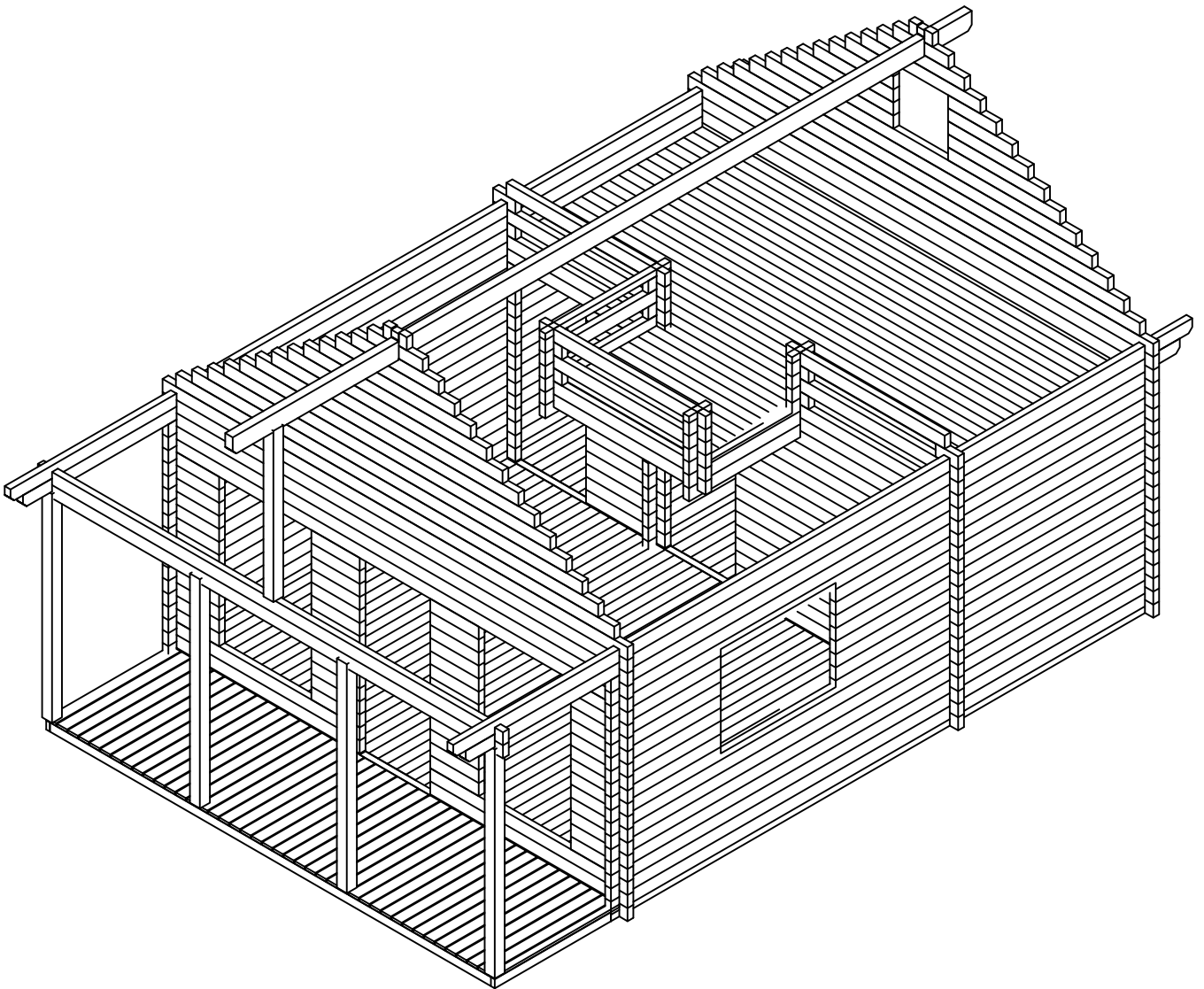

Grossglockner 70, Art.No.7011144  
GROUNDPLAN - GRUNDPLAN - PLAN DE MASSE

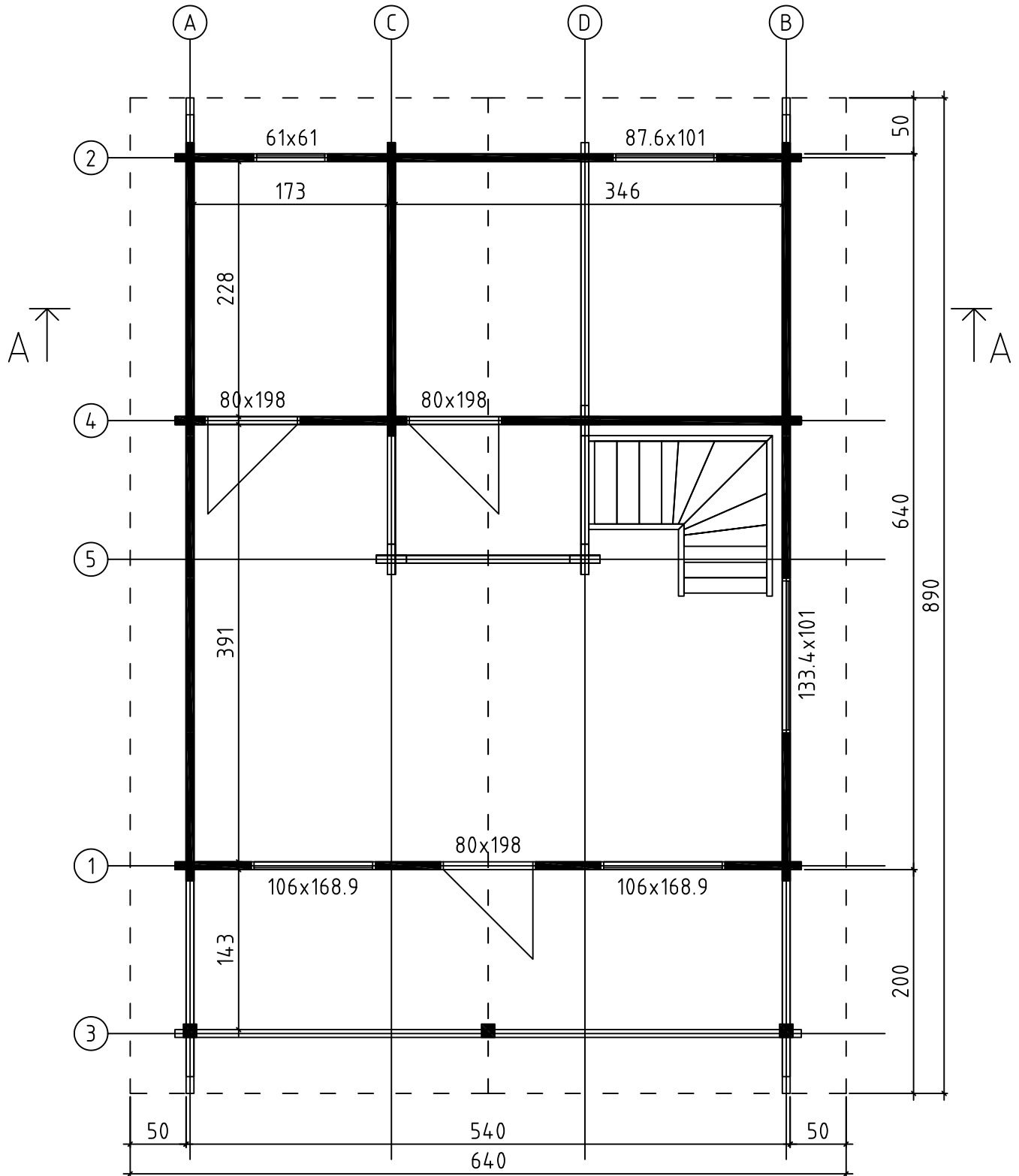

Grossglockner 70, Art.No.7011144  
GROUNDPLAN - GRUNDPLAN - PLAN DE MASSE

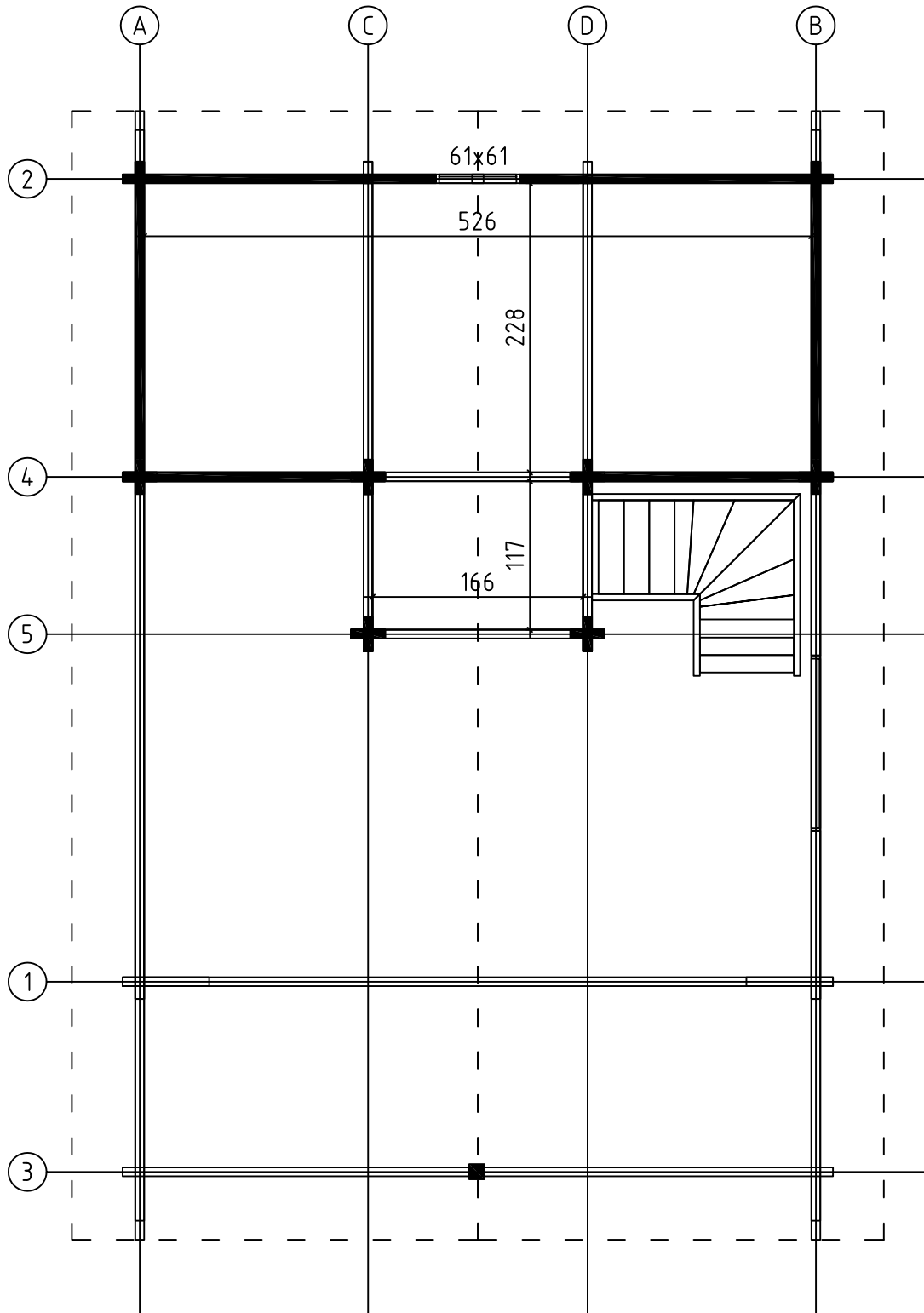

Grossglockner 70, Art.No.7011144  
 FOUNDATION - FUNDAMENT - FONDATION

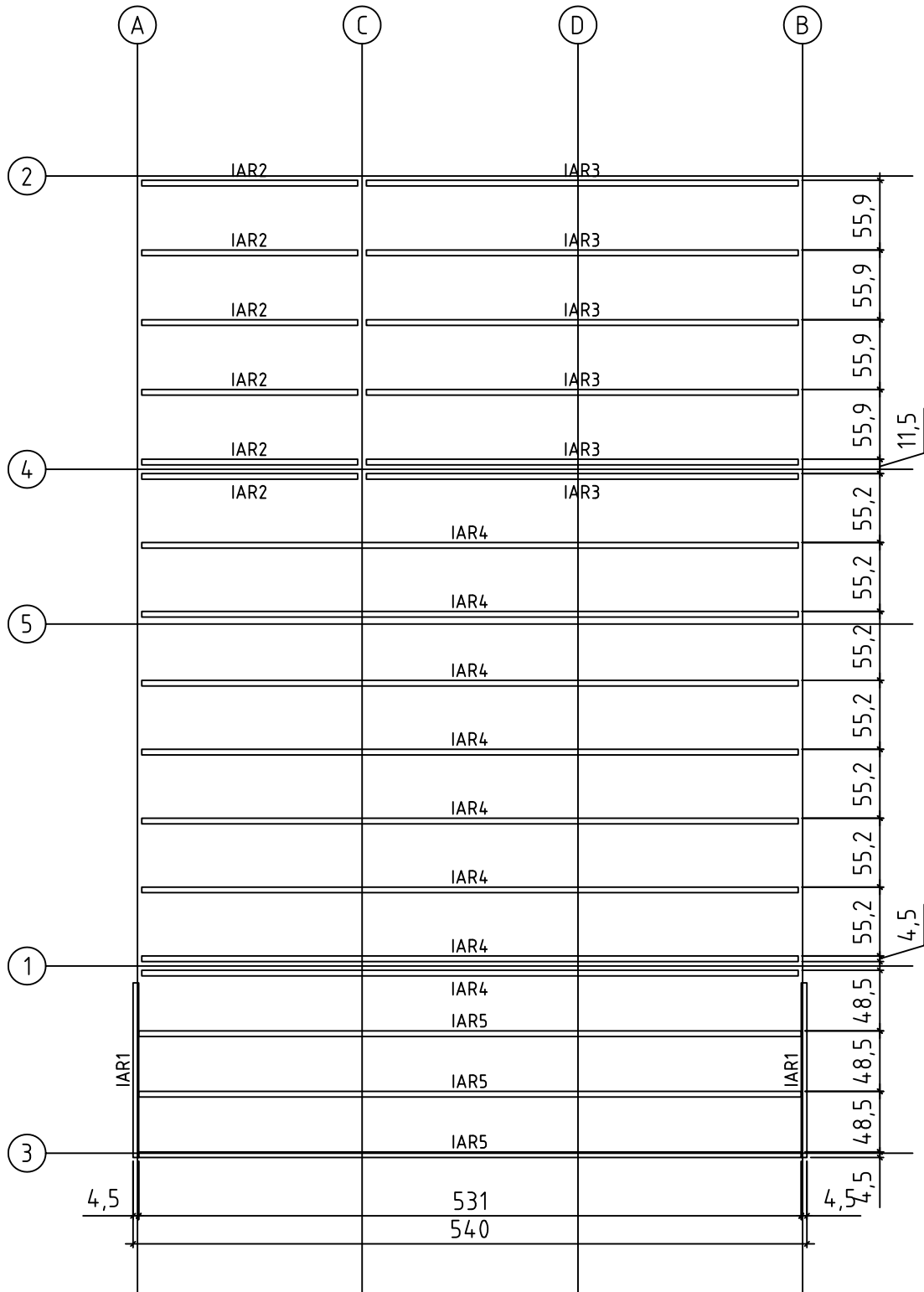

Grossglockner 70, Art.No.7011144  
RAFTERS PLAN - DACHSPARREN - PLAN DE CHEVRON

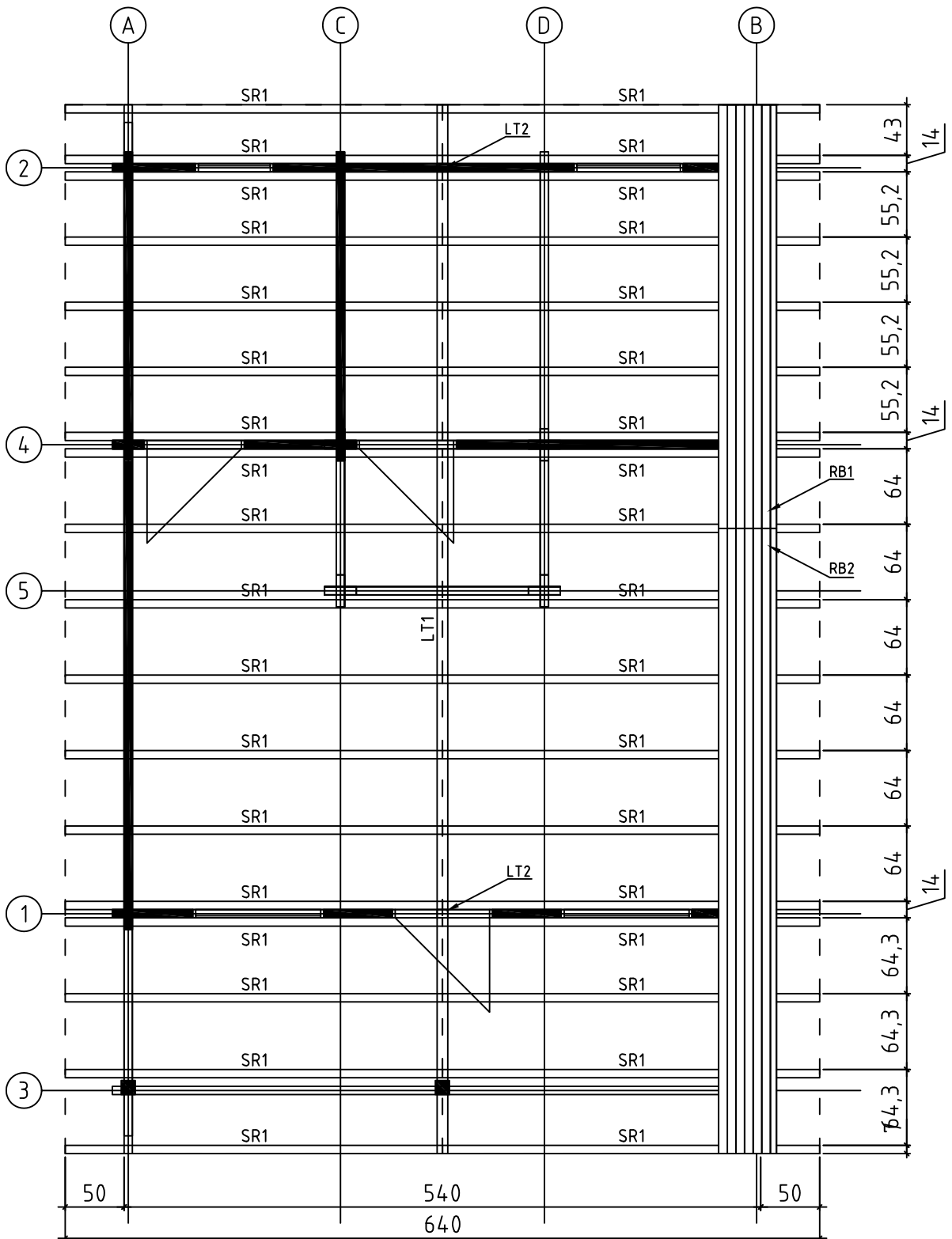

Grossglockner 70, Art.No.7011144  
MEZZANINE FLOOR JOISTS -HALBGESCHOSS BALKEN - SOLIVES DE PLANCHER MEZZANINE

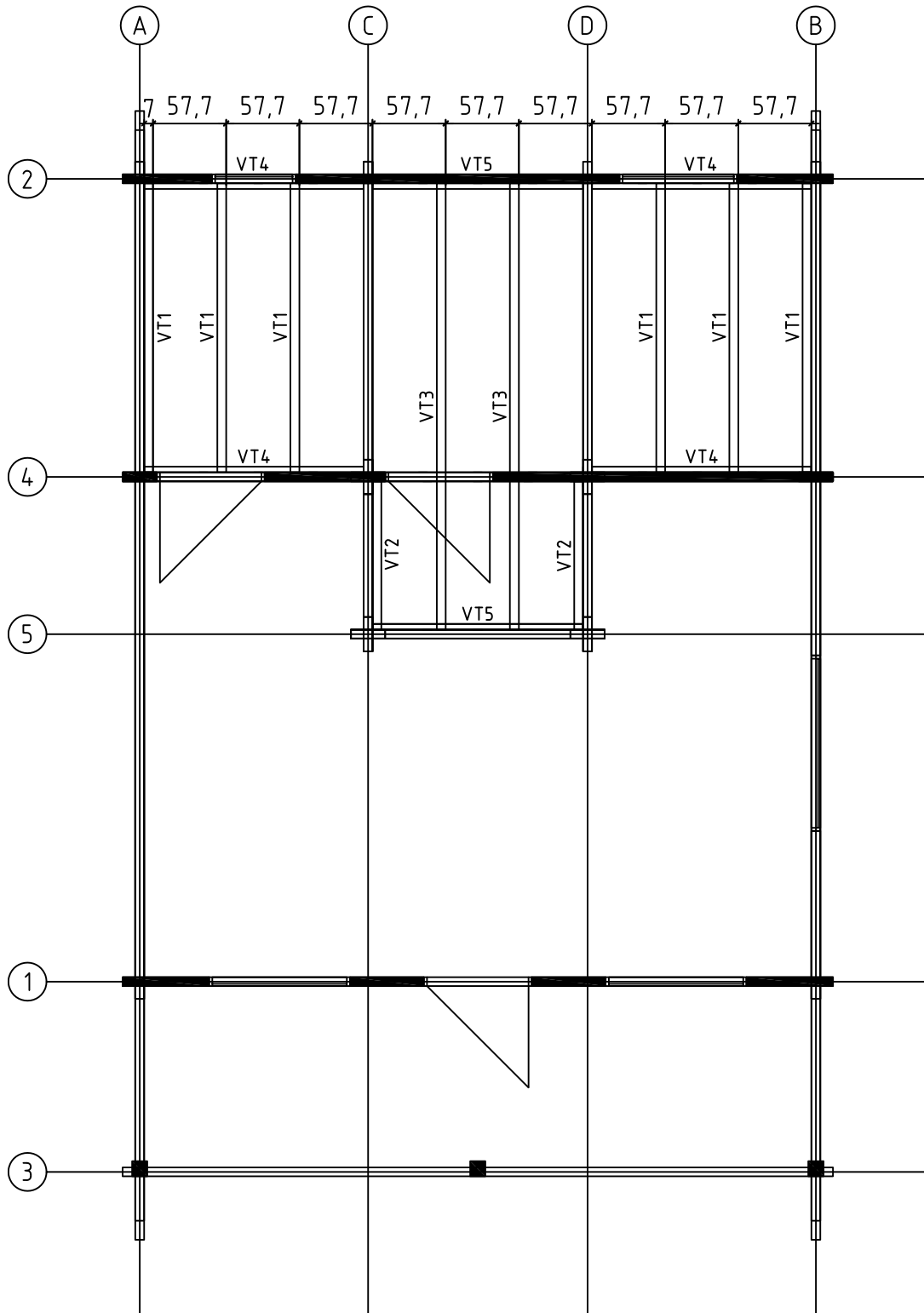

Grossglockner 70, Art.No.7011144  
FLOOR BOARDS - FUSSBODENBRETTER - PLAN POSE PLANCHER

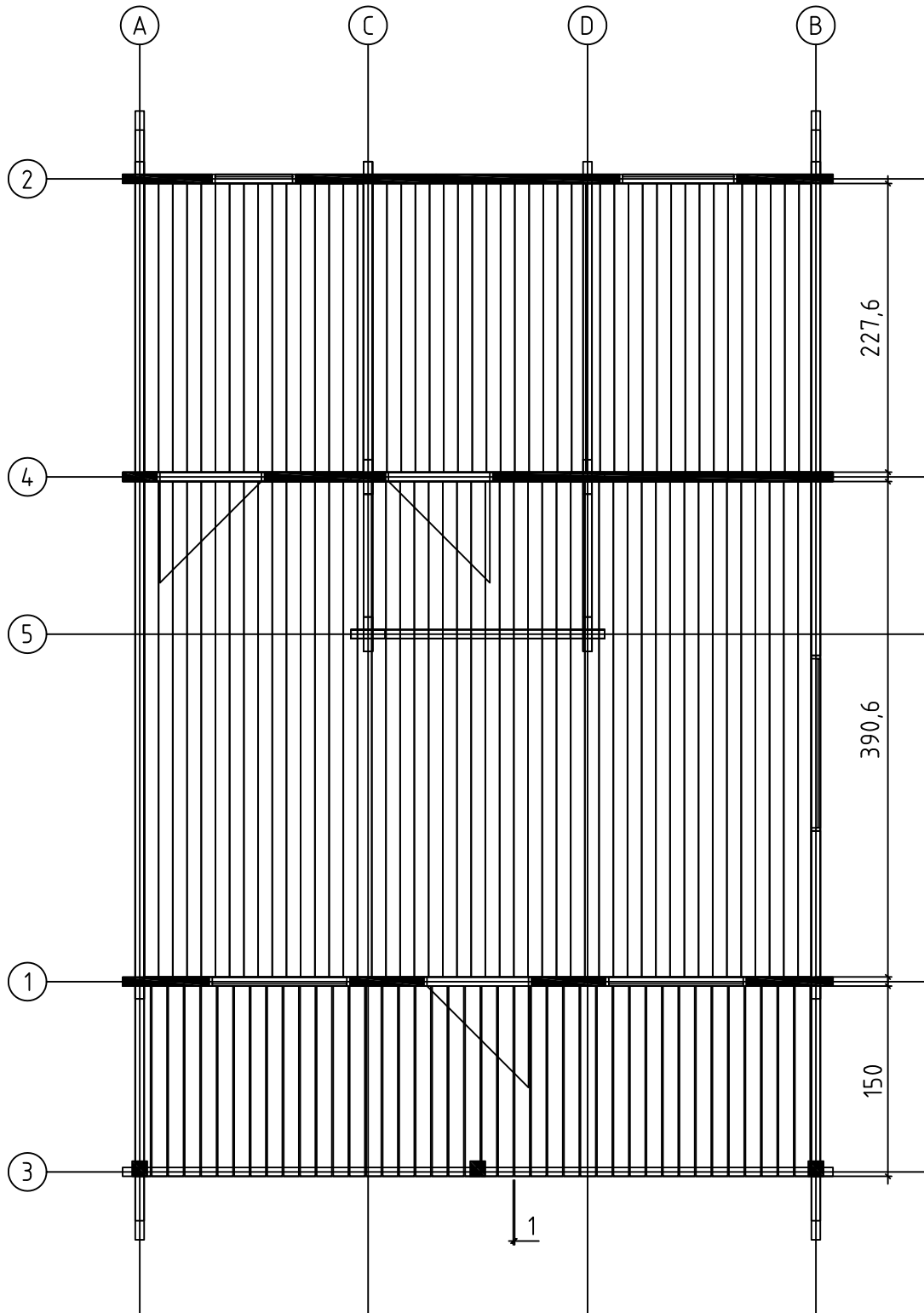

Grossglockner 70, Art.No.7011144  
FLOOR BOARDS - FUSSBODENBRETTER - PLAN POSE PLANCHER

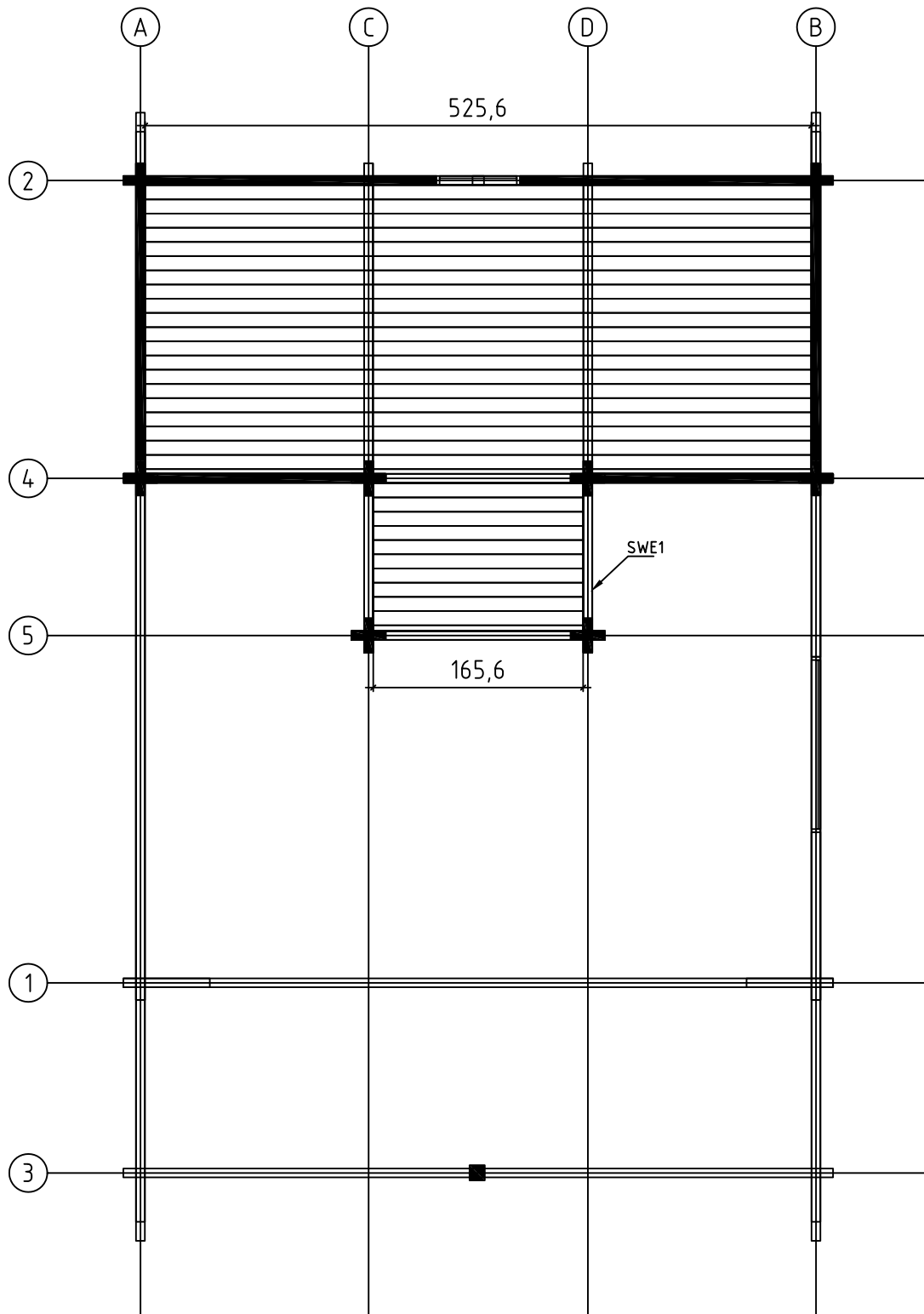



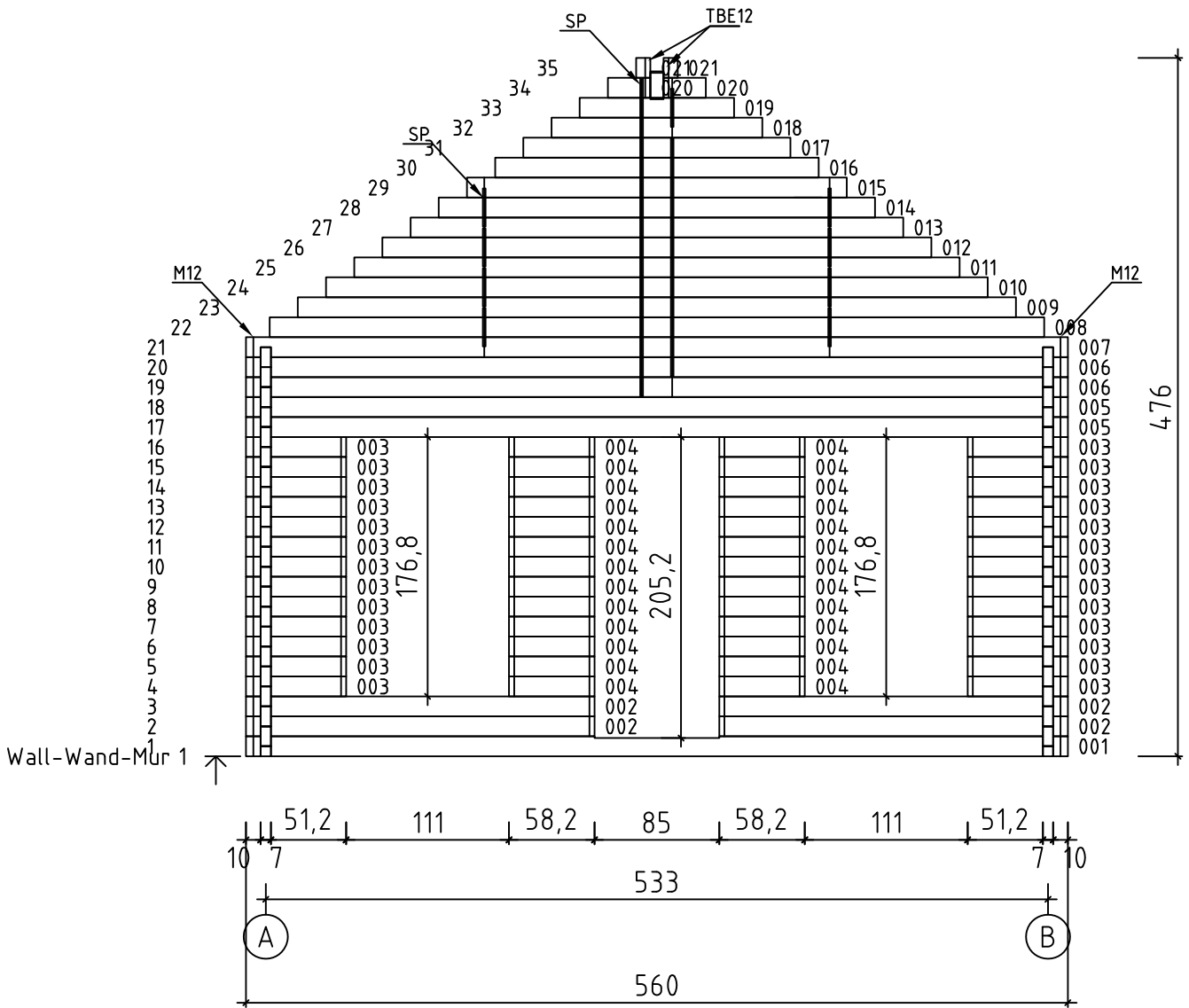

Grossglockner 70, Art.No.7011144

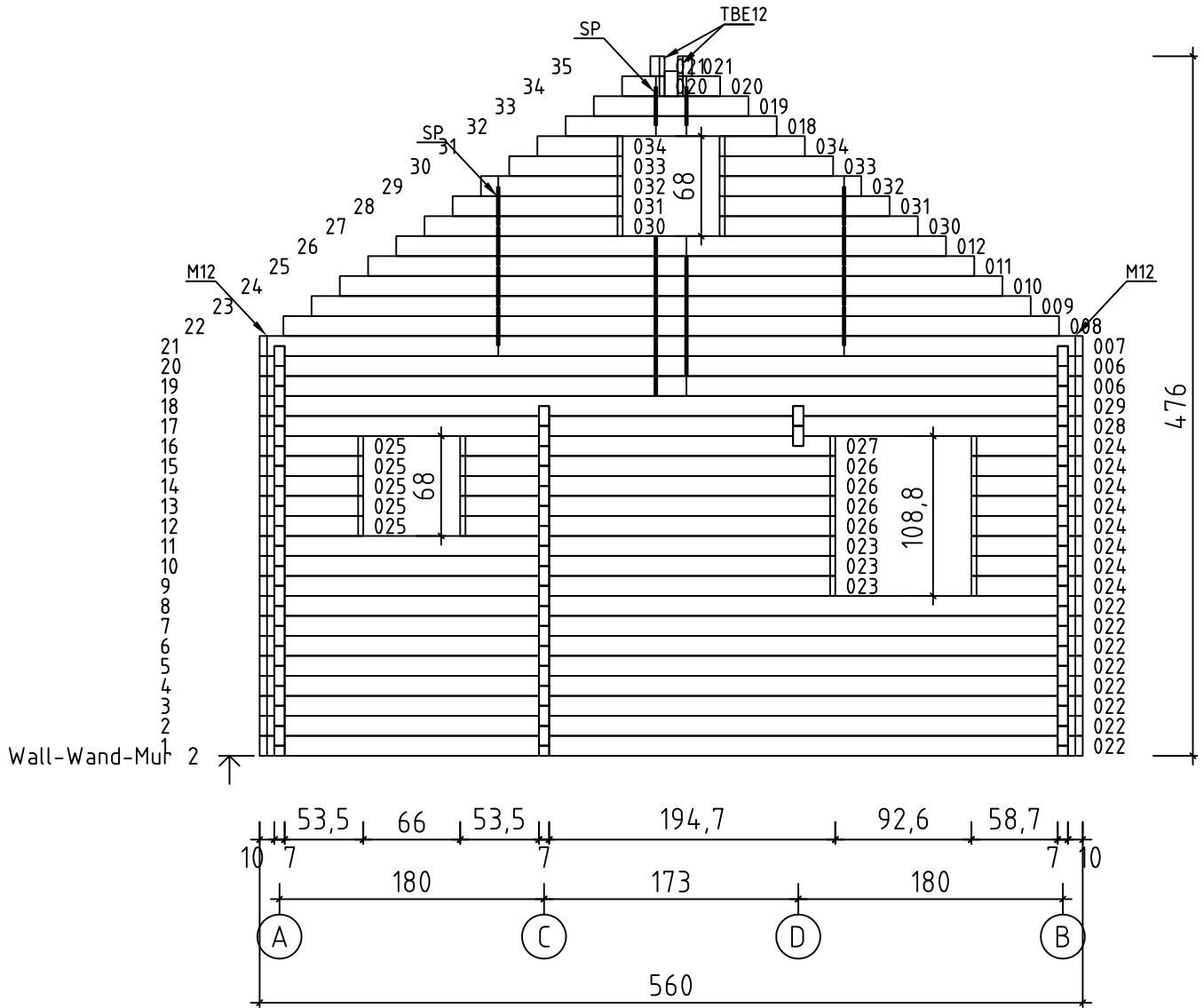

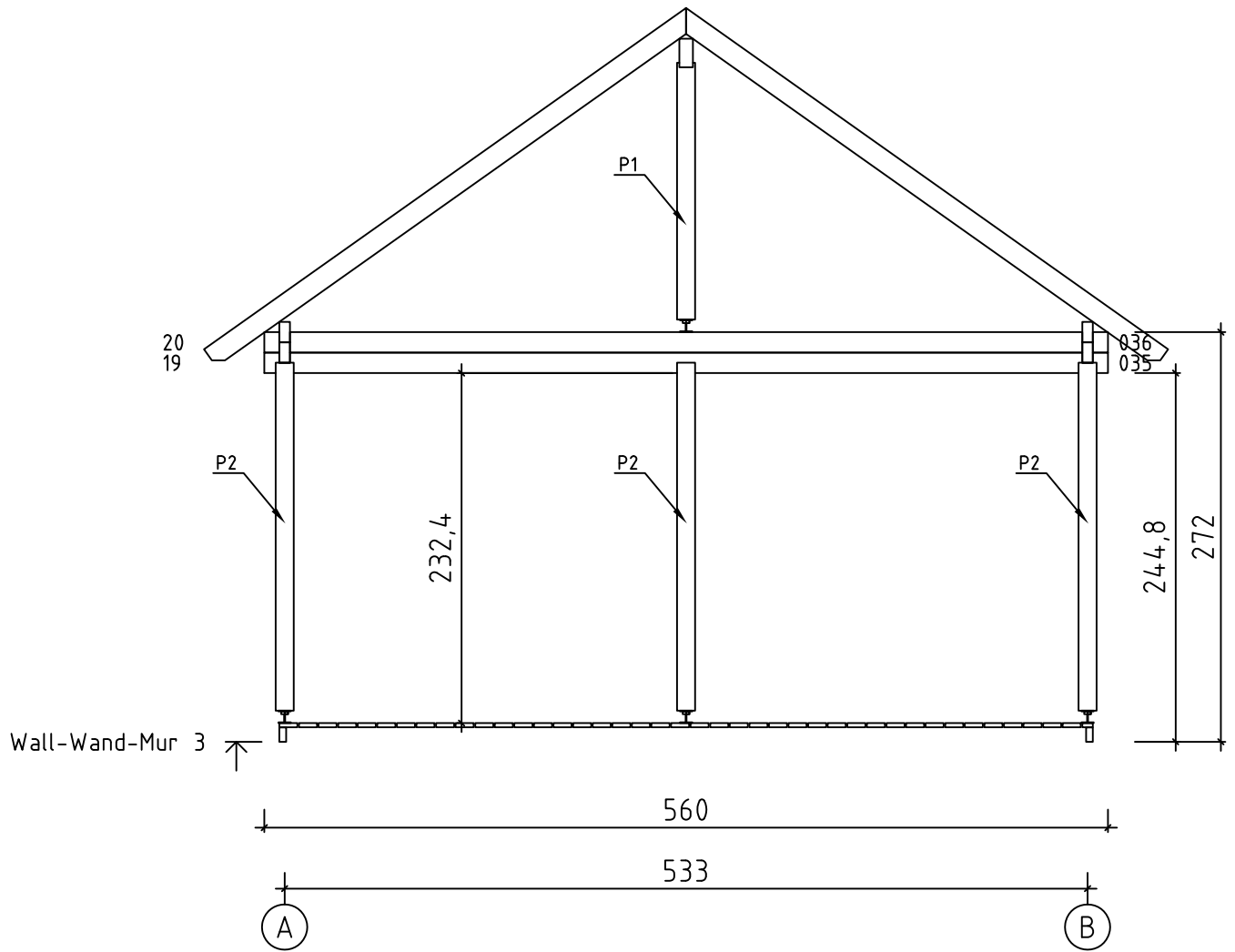

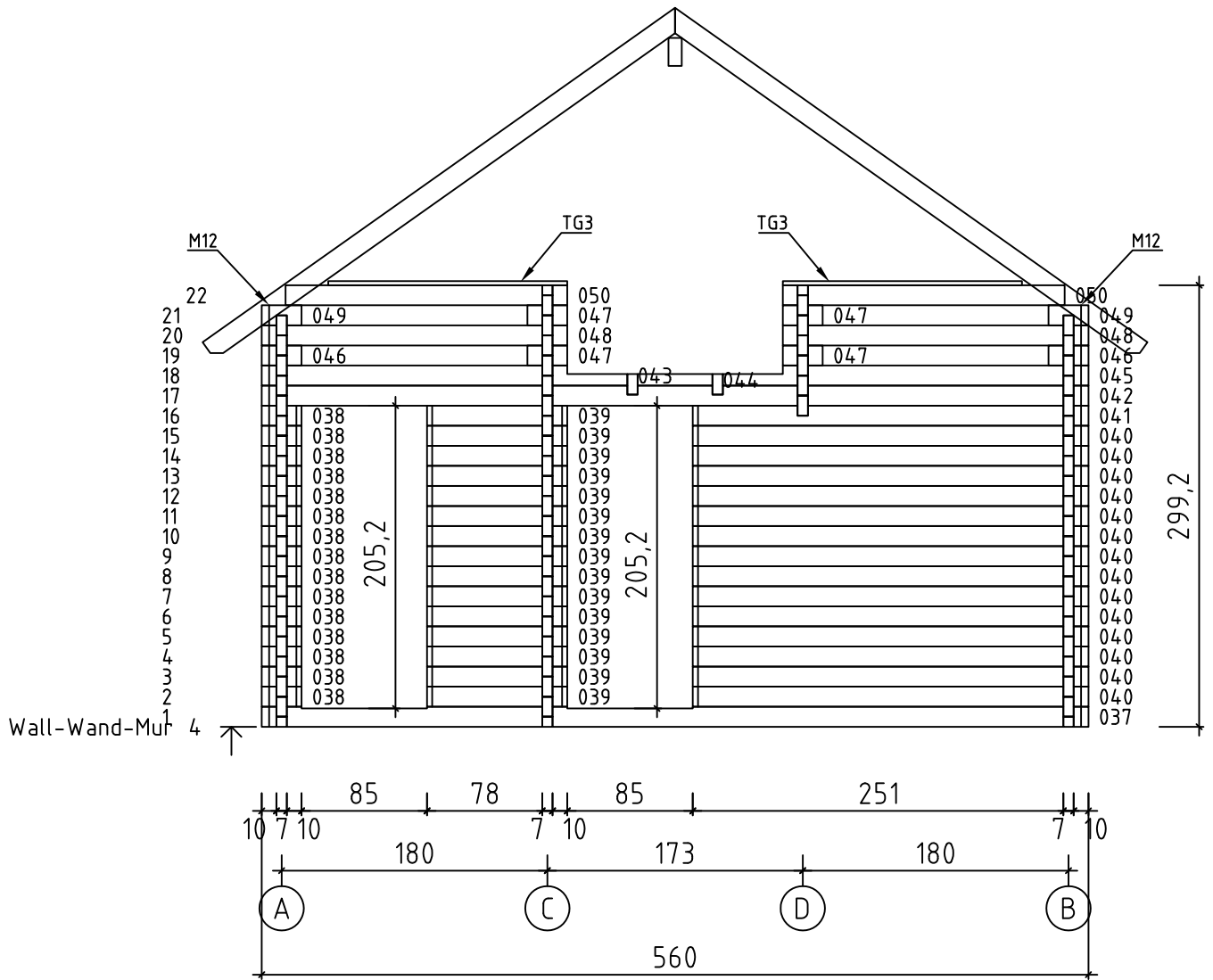

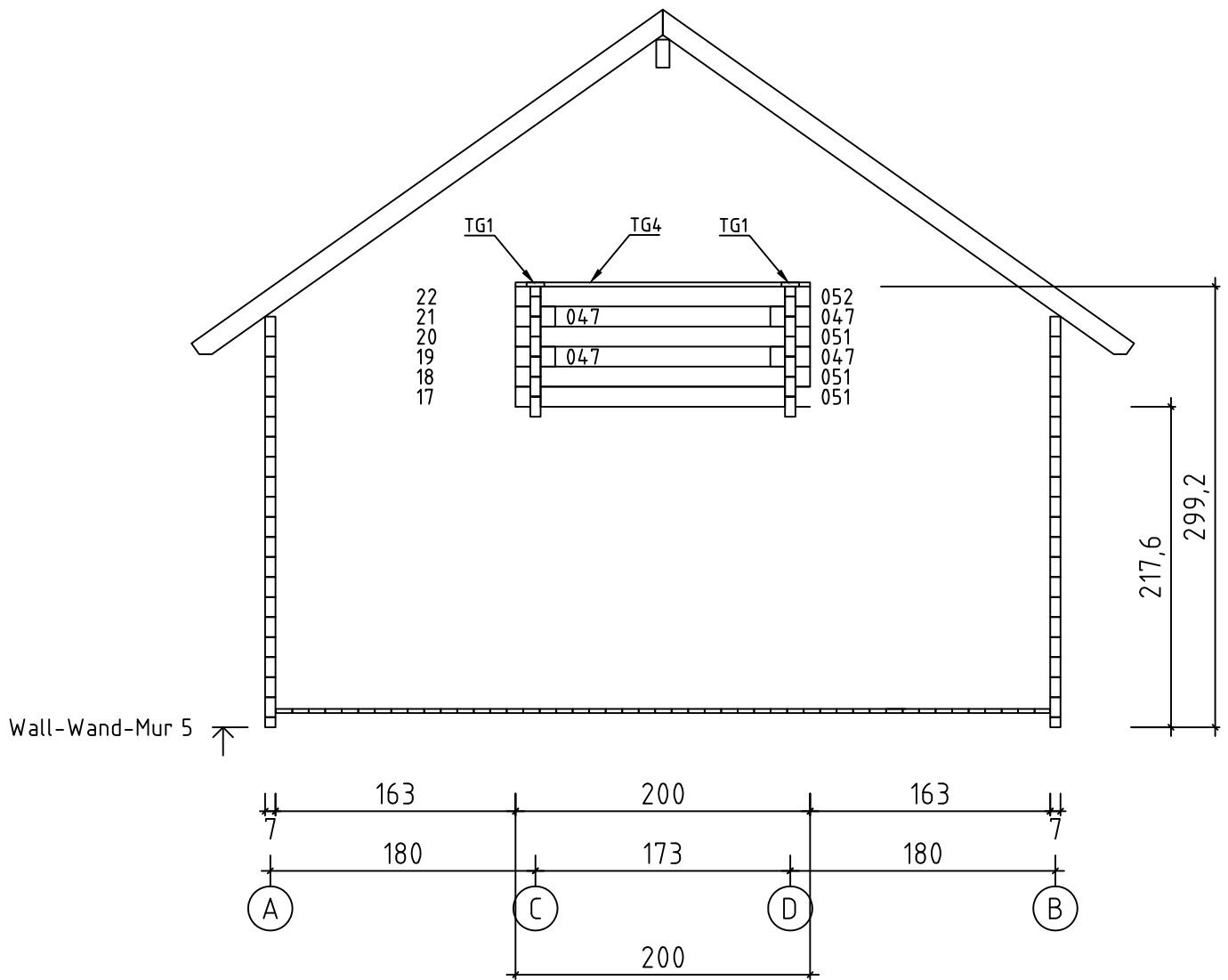

Grossglockner 70, Art.No.7011144

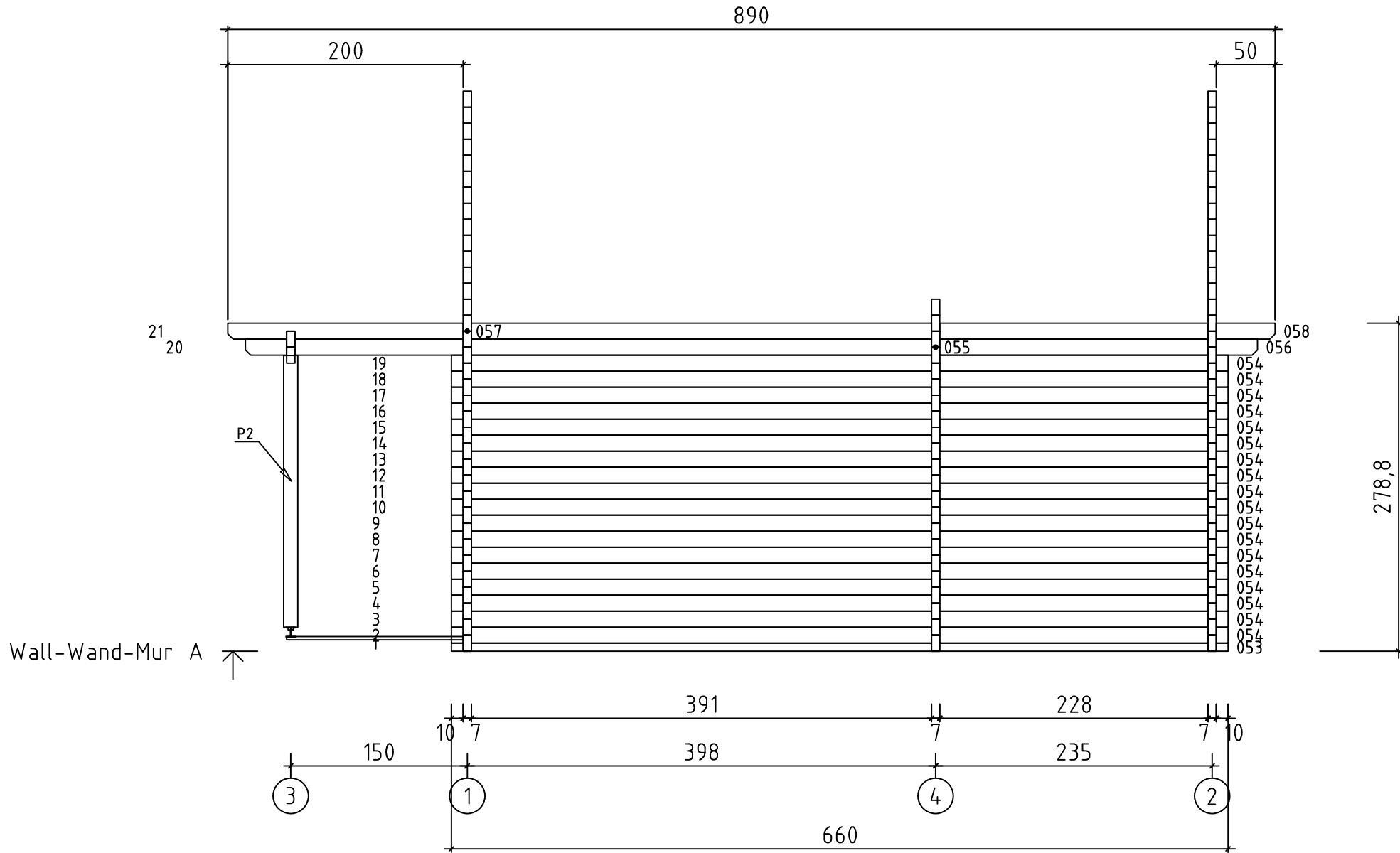

Grossglockner 70, Art.No.7011144

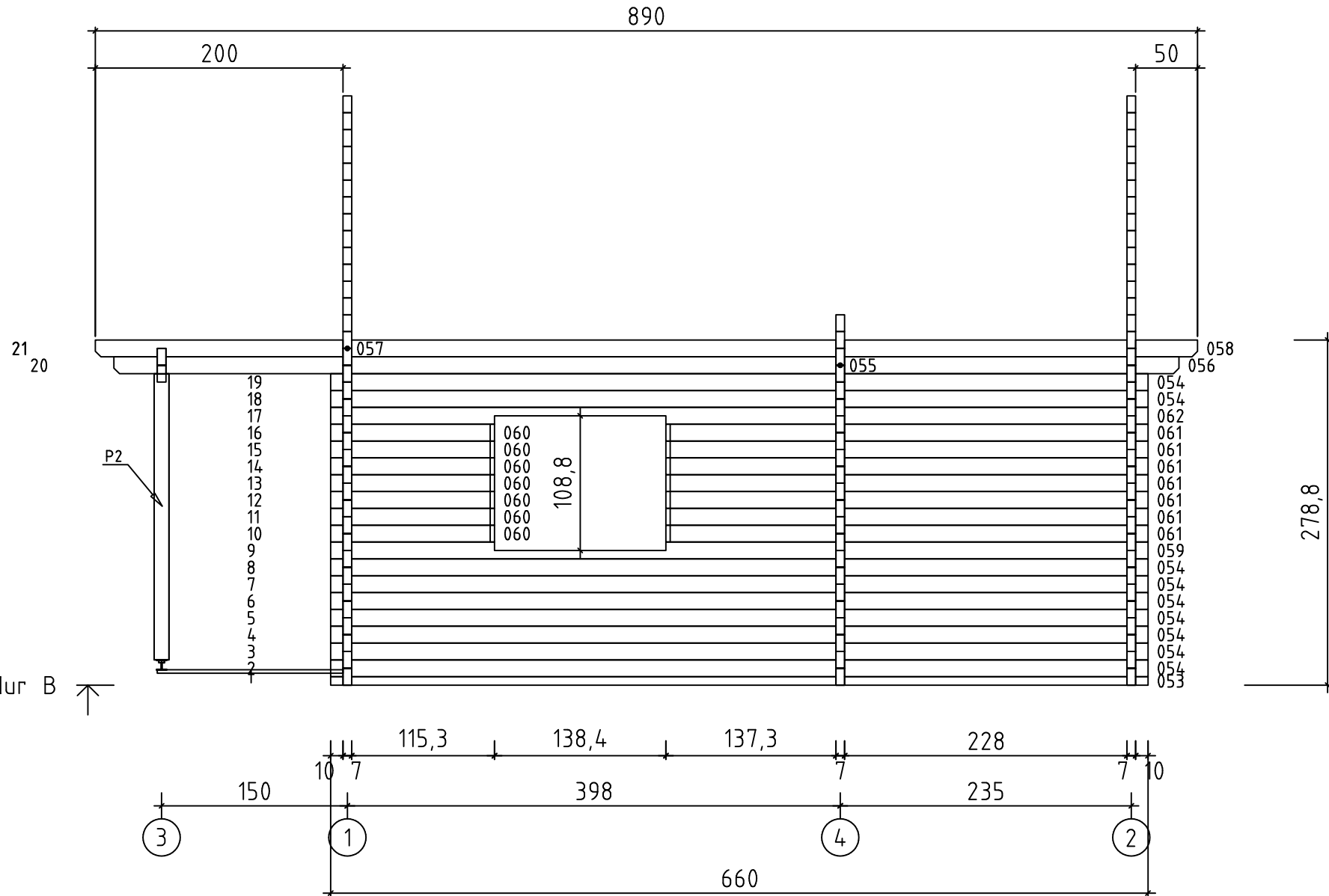

Grossglockner 70, Art.No.7011144

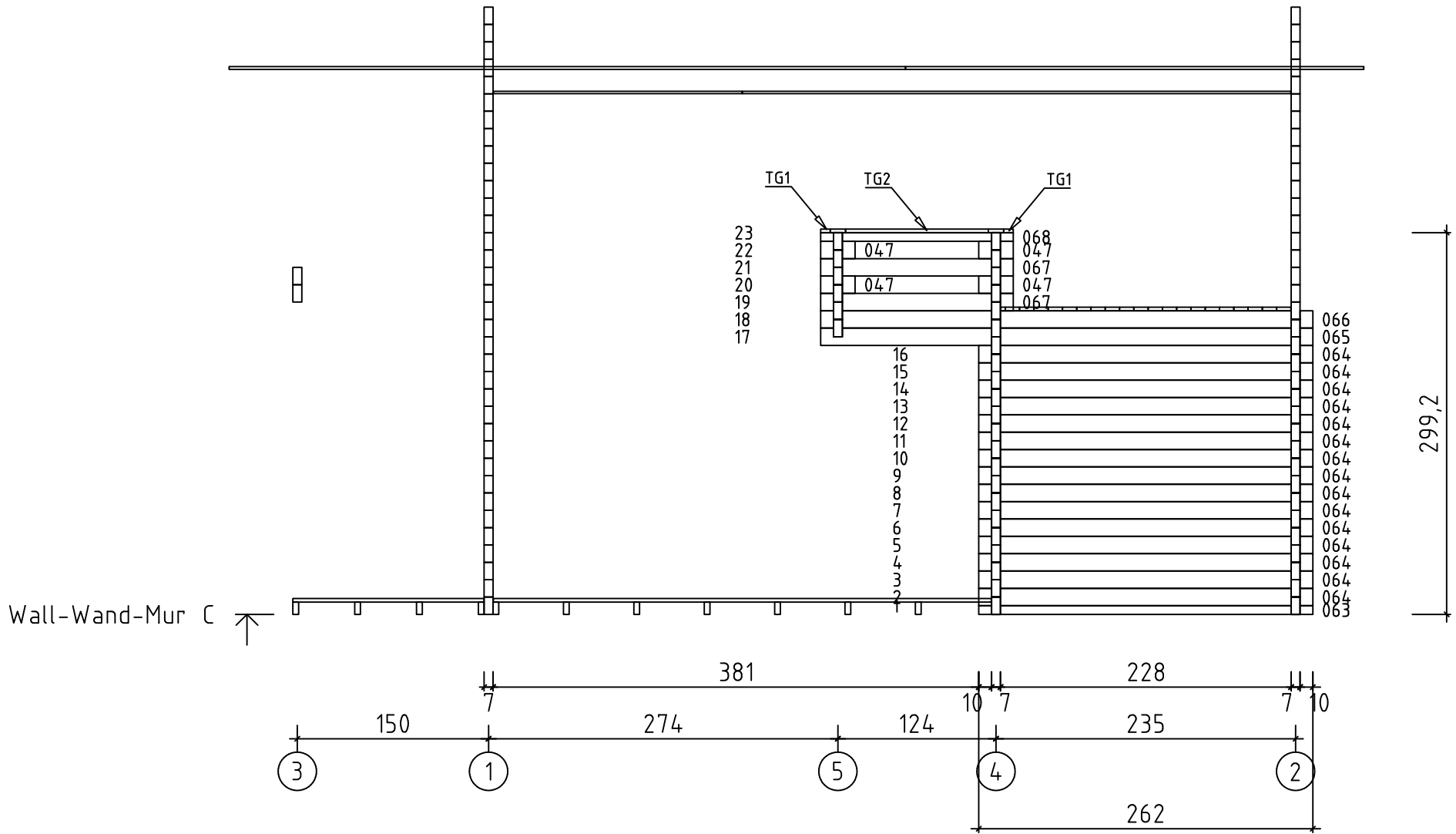





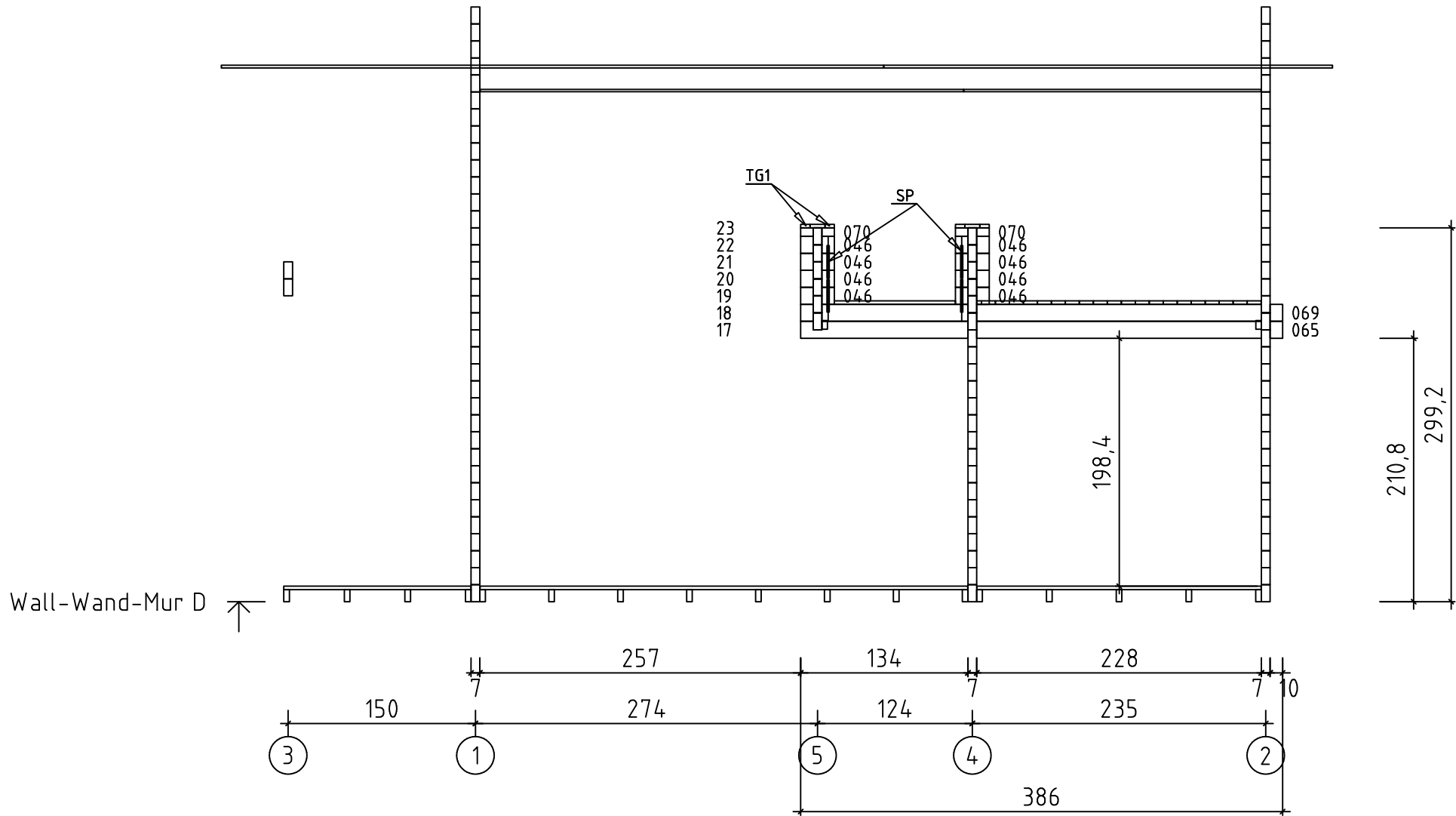

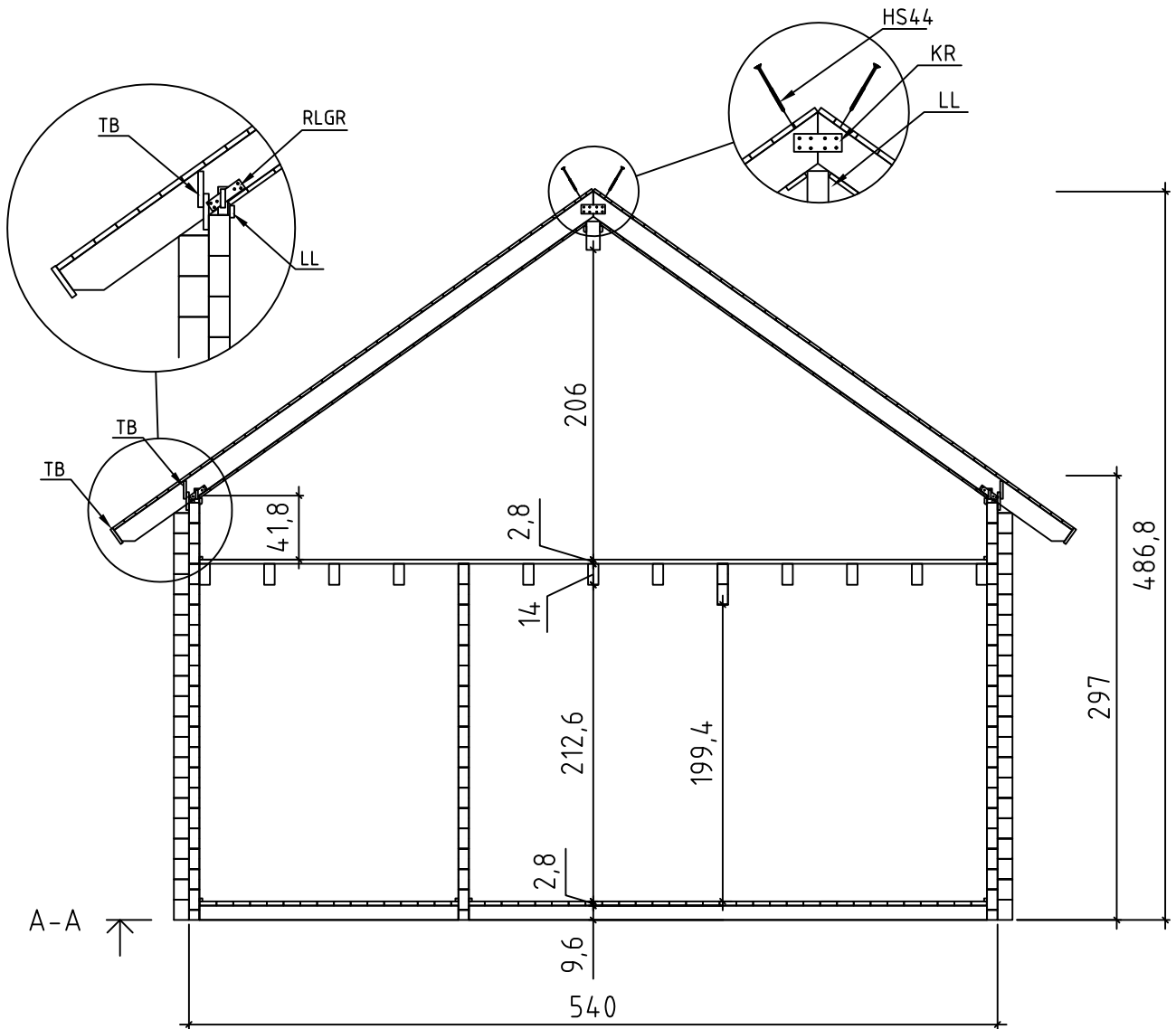

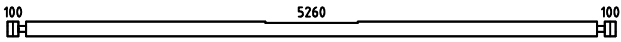
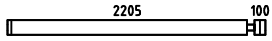

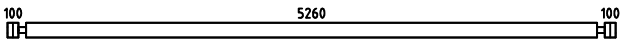
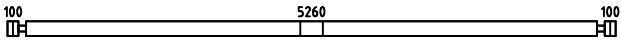
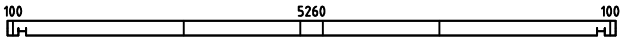
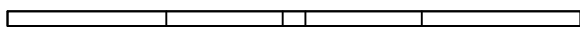
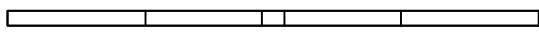
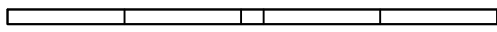
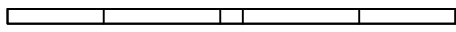
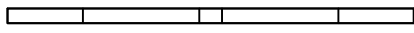
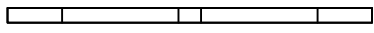
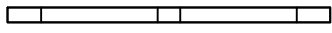
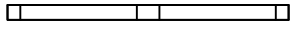
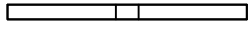
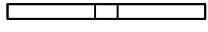
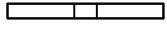
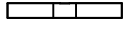

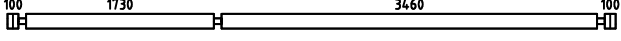
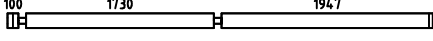



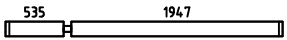
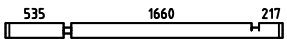
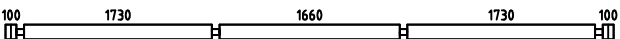
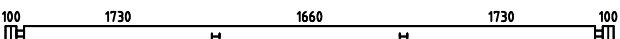
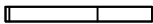



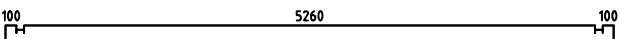
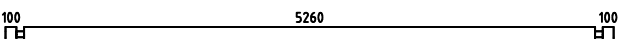
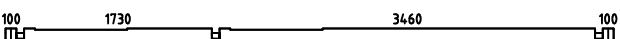

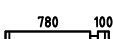
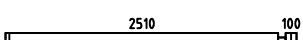
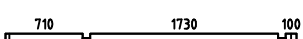
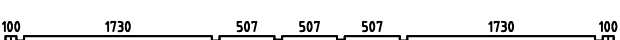
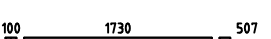
Grossglockner 70, Art.No.7011144

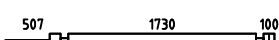

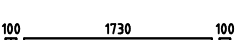



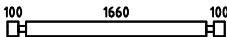
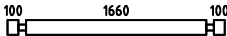
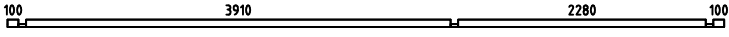
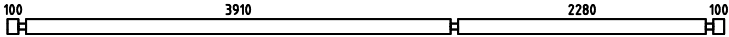
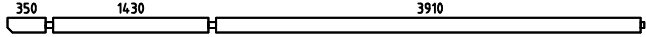
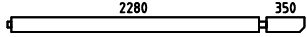
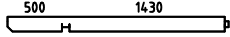
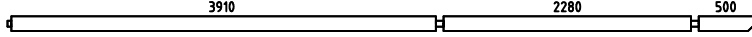
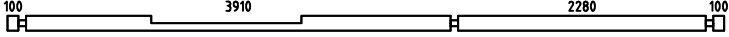
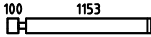
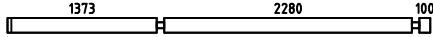
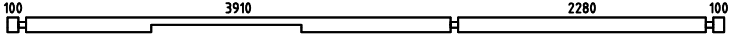
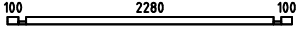
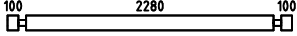
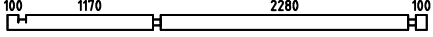
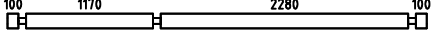
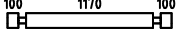
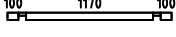
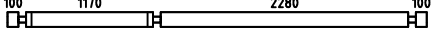

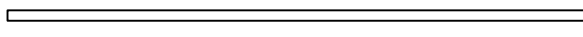
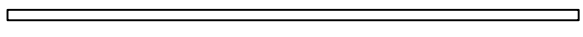
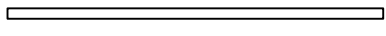
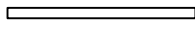
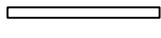













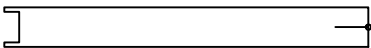
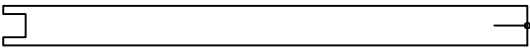
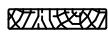
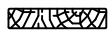
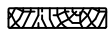
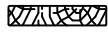

| Pos | Grossglockner 70, Art.No.7011144<br>Piece list - Stückliste - Liste des pieces      | Q. | P<br>(mm) | L<br>(mm) |
|-----|---|----|-----------|-----------|
| 001 |    | 1  | 70x136    | 5600      |
| 002 |    | 4  | 70x136    | 2375      |
| 003 |    | 26 | 70x136    | 683       |
| 004 |    | 26 | 70x136    | 583       |
| 005 |    | 2  | 70x136    | 5600      |
| 006 |    | 4  | 70x136    | 5600      |
| 007 |    | 2  | 70x136    | 5600      |
| 008 |    | 2  | 70x136    | 5277      |
| 009 |    | 2  | 70x136    | 4893      |
| 010 |    | 2  | 70x136    | 4509      |
| 011 |   | 2  | 70x136    | 4125      |
| 012 |  | 2  | 70x136    | 3741      |
| 013 |  | 1  | 70x136    | 3357      |
| 014 |  | 1  | 70x136    | 2972      |
| 015 |  | 1  | 70x136    | 2588      |
| 016 |  | 1  | 70x136    | 2204      |
| 017 |  | 1  | 70x136    | 1820      |
| 018 |  | 2  | 70x136    | 1436      |
| 019 |  | 2  | 70x136    | 1052      |
| 020 |  | 4  | 70x136    | 289       |
| 021 |  | 4  | 70x136    | 97        |
| 022 |  | 8  | 70x136    | 5600      |
| 023 |  | 3  | 70x136    | 3917      |
| 024 |  | 8  | 70x136    | 757       |
| 025 |  | 5  | 70x136    | 705       |

| Pos | Grossglockner 70, Art.No.7011144<br>Piece list - Stückliste - Liste des pieces      | Q. | P<br>(mm) | L<br>(mm) |
|-----|---|----|-----------|-----------|
| 026 |    | 4  | 70x136    | 2552      |
| 027 |    | 1  | 70x136    | 2552      |
| 028 |    | 1  | 70x136    | 5600      |
| 029 |    | 1  | 70x136    | 5600      |
| 030 |    | 2  | 70x136    | 1348      |
| 031 |    | 2  | 70x136    | 1156      |
| 032 |    | 2  | 70x136    | 964       |
| 033 |    | 2  | 70x136    | 772       |
| 034 |    | 2  | 70x136    | 580       |
| 035 |    | 1  | 70x136    | 5600      |
| 036 |   | 1  | 70x136    | 5600      |
| 037 |  | 1  | 70x136    | 5600      |
| 038 |  | 15 | 70x136    | 270       |
| 039 |  | 15 | 70x136    | 950       |
| 040 |  | 14 | 70x136    | 2680      |
| 041 |  | 1  | 70x136    | 2680      |
| 042 |  | 1  | 70x136    | 5600      |
| 043 |  | 1  | 70x136    | 2477      |
| 044 |  | 1  | 70x78     | 507       |
| 045 |  | 1  | 70x136    | 2477      |
| 046 |  | 10 | 70x136    | 270       |
| 047 |  | 12 | 70x136    | 270       |
| 048 |  | 2  | 70x136    | 2070      |
| 049 |  | 2  | 70x136    | 270       |
| 050 |  | 2  | 70x136    | 1909      |

| Pos  | Grossglockner 70, Art.No.7011144<br>Piece list - Stückliste - Liste des pieces  | Q. | P<br>(mm) | L<br>(mm) |
|------|---|----|-----------|-----------|
| 051  |    | 3  | 70x136    | 2000      |
| 052  |    | 1  | 70x136    | 2000      |
| 053  |    | 2  | 70x68     | 6600      |
| 054  |    | 27 | 70x136    | 6600      |
| 055  |    | 2  | 70x136    | 5865      |
| 056  |    | 2  | 70x136    | 2735      |
| 057  |    | 2  | 70x136    | 2035      |
| 058  |    | 2  | 70x136    | 6865      |
| 059  |    | 1  | 70x136    | 6600      |
| 060  |    | 7  | 70x136    | 1323      |
| 061  |   | 7  | 70x136    | 3893      |
| 062  |                                        | 1  | 70x136    | 6600      |
| 063  |                                        | 1  | 70x68     | 2620      |
| 064  |                                        | 15 | 70x136    | 2620      |
| 065  |                                        | 2  | 70x136    | 3860      |
| 066  |                                        | 1  | 70x136    | 3860      |
| 067  |                                        | 2  | 70x136    | 1510      |
| 068  |                                        | 1  | 70x68     | 1510      |
| 069  |                                        | 1  | 70x136    | 3860      |
| 070  |                                        | 2  | 70x68     | 270       |
| IAR5 | FOUNDATION - FUNDAMENT - FONDATION<br> | 3  | 45x96     | 5310      |
| IAR4 | FOUNDATION - FUNDAMENT - FONDATION<br> | 8  | 45x96     | 5260      |
| IAR3 | FOUNDATION - FUNDAMENT - FONDATION<br> | 6  | 45x96     | 3460      |
| IAR2 | FOUNDATION - FUNDAMENT - FONDATION<br> | 6  | 45x96     | 1730      |
| IAR1 | FOUNDATION - FUNDAMENT - FONDATION<br> | 2  | 45x95     | 1400      |

| Pos | Grossglockner 70, Art.No.7011144<br>Piece list - Stückliste - Liste des pieces   | Q. | P<br>(mm) | L<br>(mm) |
|-----|--|----|-----------|-----------|
| LT1 | MEZZANINE FLOOR JOISTS -HALBGESCHOSS BALKEN - SOLIVES DE PLANCHER MEZZANINE<br>      | 1  | 90x190    | 8900      |
| LT2 | MEZZANINE FLOOR JOISTS -HALBGESCHOSS BALKEN - SOLIVES DE PLANCHER MEZZANINE<br>       | 2  | 70x70     | 90        |
| VT3 | MEZZANINE FLOOR JOISTS -HALBGESCHOSS BALKEN - SOLIVES DE PLANCHER MEZZANINE<br>       | 2  | 70x140    | 3520      |
| VT1 | MEZZANINE FLOOR JOISTS -HALBGESCHOSS BALKEN - SOLIVES DE PLANCHER MEZZANINE<br>       | 6  | 70x140    | 2280      |
| VT2 | MEZZANINE FLOOR JOISTS -HALBGESCHOSS BALKEN - SOLIVES DE PLANCHER MEZZANINE<br>       | 2  | 70x140    | 1170      |
| VT4 | MEZZANINE FLOOR JOISTS -HALBGESCHOSS BALKEN - SOLIVES DE PLANCHER MEZZANINE<br>       | 4  | 45x70     | 1730      |
| VT5 | MEZZANINE FLOOR JOISTS -HALBGESCHOSS BALKEN - SOLIVES DE PLANCHER MEZZANINE<br>       | 2  | 45x70     | 1660      |
| SR1 | RAFTER - DACHSPARREN - CHEVRON<br>  | 36 | 70x140    | 3921      |
| STP | CEILING BOARDS - DECKENBRETTER - VOLIGES SOUS PLAFOND                               | 29 | 111x15    | 4303      |
| STP | CEILING BOARDS - DECKENBRETTER - VOLIGES SOUS PLAFOND                               | 29 | 111x15    | 3873      |
| STP | CEILING BOARDS - DECKENBRETTER - VOLIGES SOUS PLAFOND                               | 29 | 111x15    | 2383      |
| STP | CEILING BOARDS - DECKENBRETTER - VOLIGES SOUS PLAFOND                             | 29 | 111x15    | 1953      |
| PTL | FLOOR BOARDS - FUSSBODENBRETTER - LAME DE PLANCHER                                | 21 | 112x28    | 5256      |
| PTL | FLOOR BOARDS - FUSSBODENBRETTER - LAME DE PLANCHER                                | 47 | 112x28    | 3906      |
| PTL | FLOOR BOARDS - FUSSBODENBRETTER - LAME DE PLANCHER                                | 39 | 112x28    | 2276      |
| PTL | FLOOR BOARDS - FUSSBODENBRETTER - LAME DE PLANCHER                                | 8  | 112x28    | 2275      |
| PTL | FLOOR BOARDS - FUSSBODENBRETTER - LAME DE PLANCHER                                | 11 | 112x28    | 1656      |
|     | ROOF BOARDS - DACHBRETTER - VOLIGES   | 88 | 90x18     | 5305      |
|     | ROOF BOARDS - DACHBRETTER - VOLIGES   | 88 | 90x18     | 3595      |
| SV2 | TERRACE BOARDS - TERRASSENBRETTER - PLANCHER DE TERRASSE                          | 42 | 120x28    | 1500      |
|     | FLOOR FILLET-FUSSBODENLEISTE - CORNIERE DE FINITION DU PLANCHER                   |    | 18x18     | 55.3 m.   |
| LL  | CEILING FILLET - DECKELEISTE - PROFIL DE FINITION POUR SOUS PLAFOND               |    | 15x40     | 37.8 m.   |
| DPL | ROOFING FELT FILLET - DACHPAPPENLEISTE - BAGUETTE DE FIXATION DU FEUTRE BITUMEUX  | 32 | 18x58     | 5000      |
| M12 | TREADED ROD M12 - GEWINDESTANGE M12 - TIGE FILETÉE M12                            | 6  |           | 890       |
| M12 | TREADED ROD M12 - GEWINDESTANGE M12 - TIGE FILETÉE M12                             | 6  |           | 2000      |

| Pos   | Grossglockner 70, Art.No.7011144<br>Piece list - Stückliste - Liste des pieces   | Q. | P<br>(mm) | L<br>(mm) |
|-------|--|----|-----------|-----------|
| LPL   | FIXING FILLET - FIXIRUNGSLEISTE - PROFIL DE FIXATION                                        | 4  | 20x70     | 610       |
| LPL   | FIXING FILLET - FIXIRUNGSLEISTE - PROFIL DE FIXATION                                        | 4  | 20x70     | 650       |
| LPL   | FIXING FILLET - FIXIRUNGSLEISTE - PROFIL DE FIXATION                                        | 3  | 20x70     | 800       |
| LPL   | FIXING FILLET - FIXIRUNGSLEISTE - PROFIL DE FIXATION                                        | 2  | 20x70     | 876       |
| LPL   | FIXING FILLET - FIXIRUNGSLEISTE - PROFIL DE FIXATION                                        | 4  | 20x70     | 1050      |
| LPL   | FIXING FILLET - FIXIRUNGSLEISTE - PROFIL DE FIXATION                                        | 4  | 20x70     | 1060      |
| LPL   | FIXING FILLET - FIXIRUNGSLEISTE - PROFIL DE FIXATION                                        | 2  | 20x70     | 1334      |
| LPL   | FIXING FILLET - FIXIRUNGSLEISTE - PROFIL DE FIXATION                                        | 4  | 20x70     | 1729      |
| LPL   | FIXING FILLET - FIXIRUNGSLEISTE - PROFIL DE FIXATION                                        | 6  | 20x70     | 2000      |
| SWE1  | DOORSTEP - SWELLE - SEUIL DE PORTE    | 1  | 28x74     | 970       |
| P     | POST - PFOSTEN - POTEAU   | 1  | 120x120   | 1705      |
| P     | POST - PFOSTEN - POTEAU    | 3  | 120x120   | 2310      |
| TB    | EAVES BOARD - TRAUFBRETT - BANDEAU DE TOIT    | 16 | 18x120    | 282       |
| TB    | EAVES BOARD - TRAUFBRETT - BANDEAU DE TOIT    | 24 | 18x120    | 570       |
| TB    | EAVES BOARD - TRAUFBRETT - BANDEAU DE TOIT    | 2  | 18x120    | 3595      |
| TB    | EAVES BOARD - TRAUFBRETT - BANDEAU DE TOIT    | 2  | 18x120    | 5305      |
| TBE12 | FIXING FILLET - FIXIRUNGSLEISTE - PROFIL DE FIXATION                                      | 4  | 28x34     | 260       |
| TBE6  | FIXING FILLET FOR WINDOW - FIXIRUNGSLEISTE FÜR FENSTER - PROFIL DE FIXATION DES FENETRES  | 4  | 28x34     | 650       |
| TBE6  | FIXING FILLET FOR WINDOW - FIXIRUNGSLEISTE FÜR FENSTER - PROFIL DE FIXATION DES FENETRES  | 2  | 28x34     | 884       |
| TBE6  | FIXING FILLET FOR WINDOW - FIXIRUNGSLEISTE FÜR FENSTER - PROFIL DE FIXATION DES FENETRES  | 2  | 28x34     | 1050      |
| TBE6  | FIXING FILLET FOR WINDOW - FIXIRUNGSLEISTE FÜR FENSTER - PROFIL DE FIXATION DES FENETRES  | 4  | 28x34     | 1729      |
| TBE6  | FIXING FILLET FOR DOOR - FIXIRUNGSLEISTE FÜR TÜR - PROFIL DE FIXATION DES PORTES          | 6  | 28x34     | 1990      |
| TG1   | GUARD-RAIL FOR TERRACE - TERRASSEN GELÄNDER - MAIN COURANTE DE TERRASSE                   | 6  | 28x120    | 75        |
| TG1   | GUARD-RAIL FOR TERRACE - TERRASSEN GELÄNDER - MAIN COURANTE DE TERRASSE                   | 1  | 28x120    | 1120      |
| TG1   | GUARD-RAIL FOR TERRACE - TERRASSEN GELÄNDER - MAIN COURANTE DE TERRASSE                   | 2  | 28x120    | 1616      |



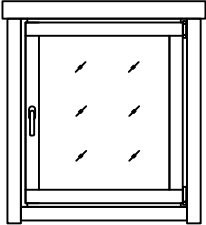
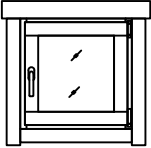
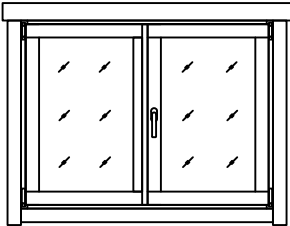
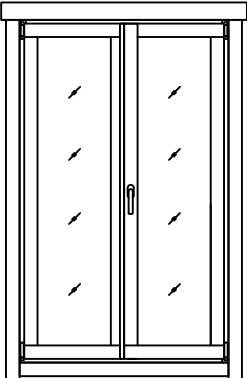
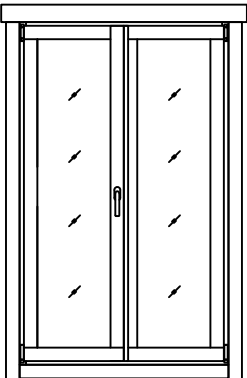

| Pos | Grossglockner 70, Art.No.7011144<br>Piece list - Stückliste - Liste des pieces  | Q. | P<br>(mm) | L<br>(mm) |
|-----|---|----|-----------|-----------|
|     | WINDOW-FENSTER-FENETRE 916x1050<br>    | 1  |           |           |
|     | WINDOW-FENSTER-FENETRE 650x650<br>     | 2  |           |           |
|     | WINDOW-FENSTER-FENETRE 1374x1050<br>  | 1  |           |           |
|     | WINDOW-FENSTER-FENETRE 1100x1729<br> | 1  |           |           |
|     | WINDOW-FENSTER-FENETRE 1100x1729<br> | 1  |           |           |
|     |   |    |           |           |

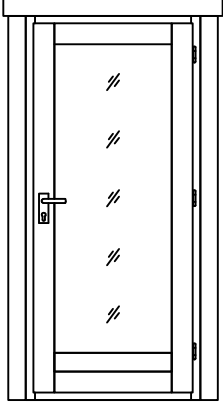
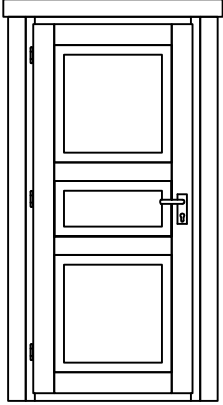
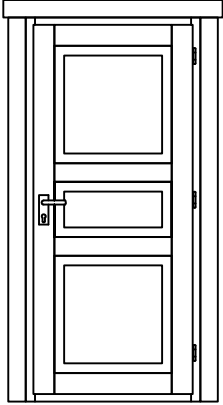
| Pos | Grossglockner 70, Art.No.7011144<br>Piece list - Stückliste - Liste des pieces                               | Q. | P<br>(mm) | L<br>(mm) |
|-----|--|----|-----------|-----------|
|     | DOOR-TÜR-PORTE 84x200<br>   | 1  |           |           |
|     | DOOR-TÜR-PORTE 84x200<br>  | 1  |           |           |
|     | DOOR-TÜR-PORTE 84x200<br> | 1  |           |           |
|     |  |    |           |           |
|     |  |    |           |           |
|     |  |    |           |           |
|     |  |    |           |           |
|     |  |    |           |           |
|     |  |    |           |           |