

Domeo 6
Art. Nr. 4424919
1/11

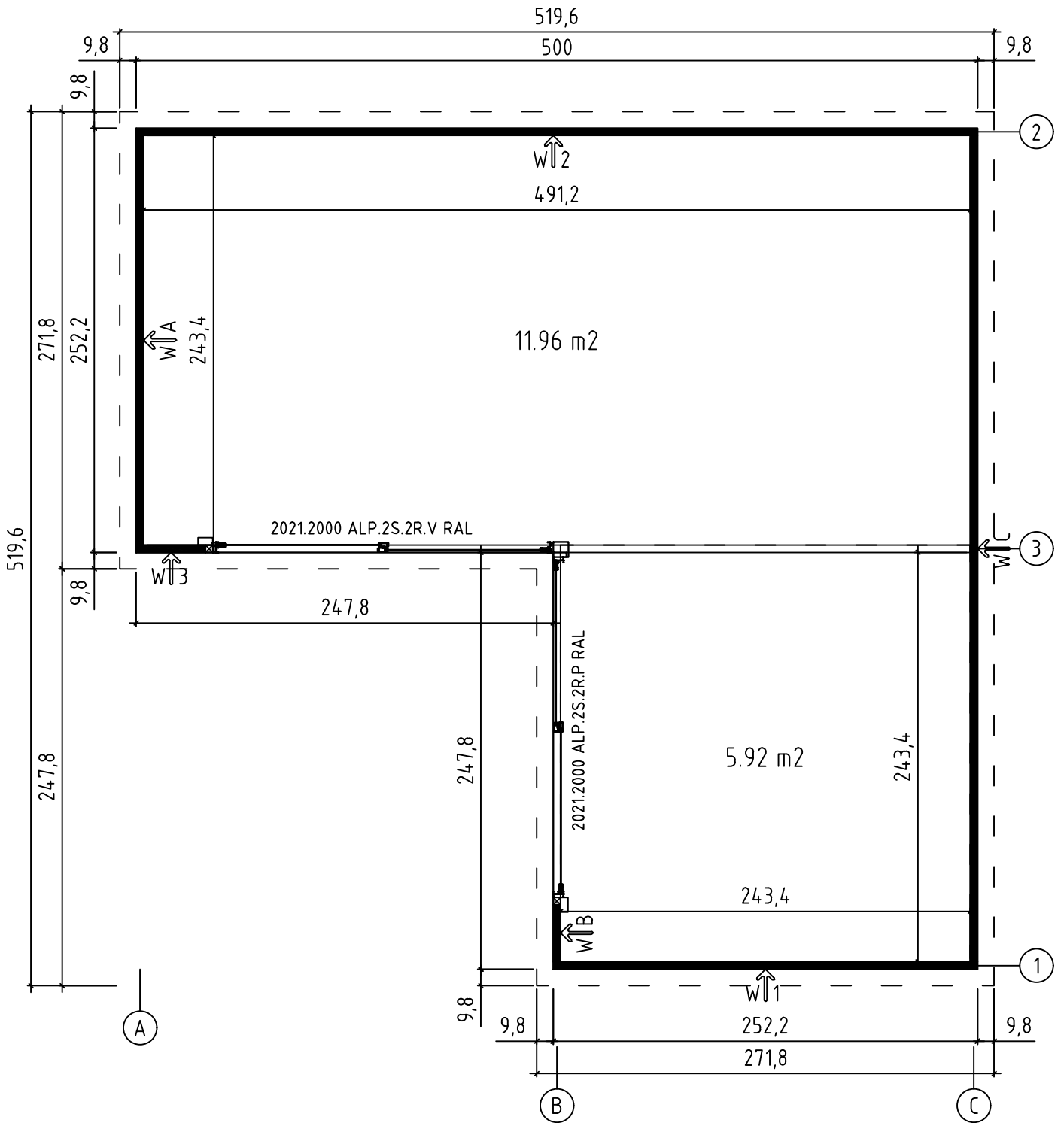

02.08.2024

Groundplan - Grundplan - Plan de masse - Planimetria -
Plattegrond - Planimetría - Põhiplaan



Foundation - Fundament - Fondation - Fundamenta - Fundering -
Bastidor - Immutatud alusraam

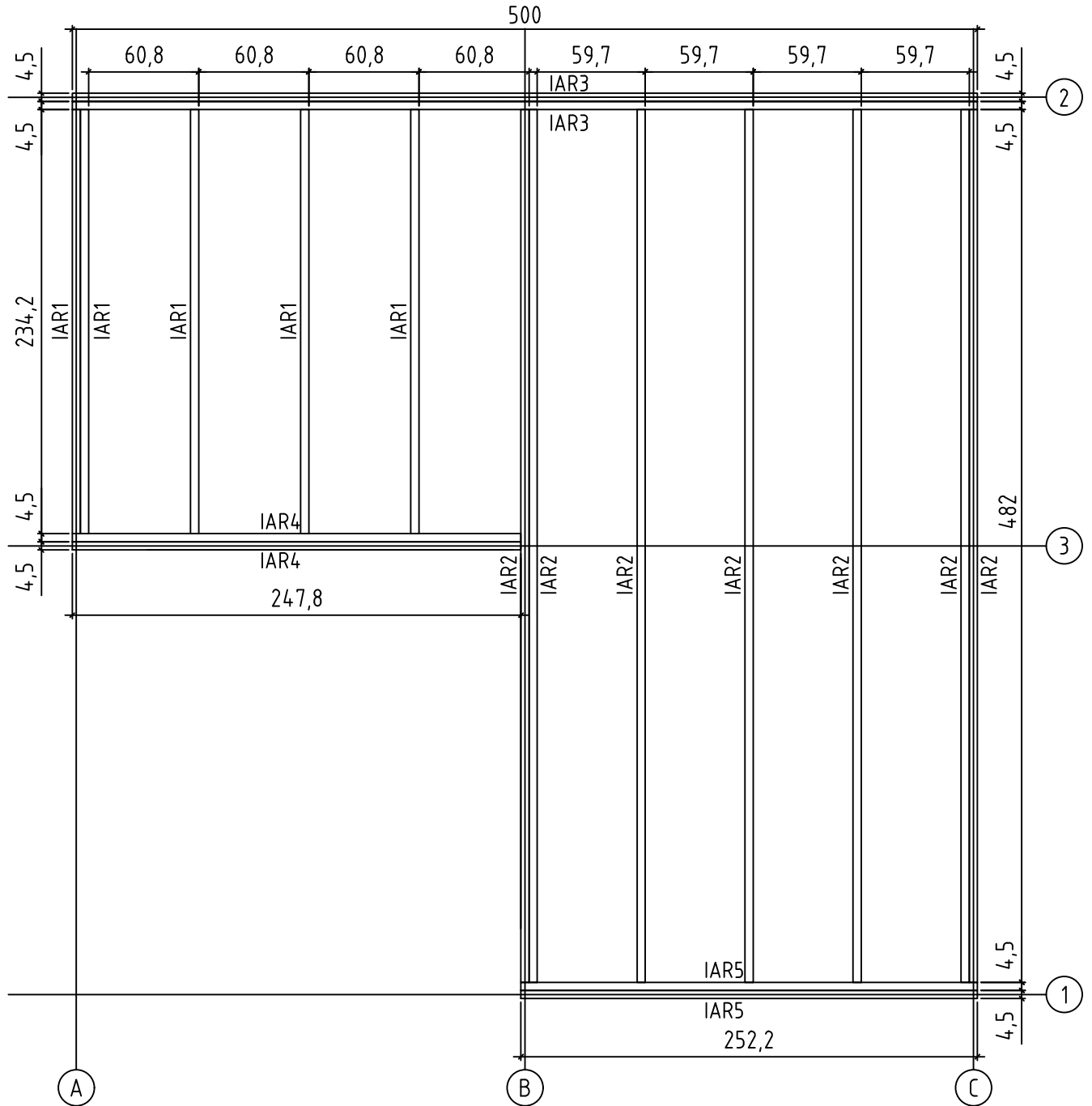

Art. Nr. 4424919



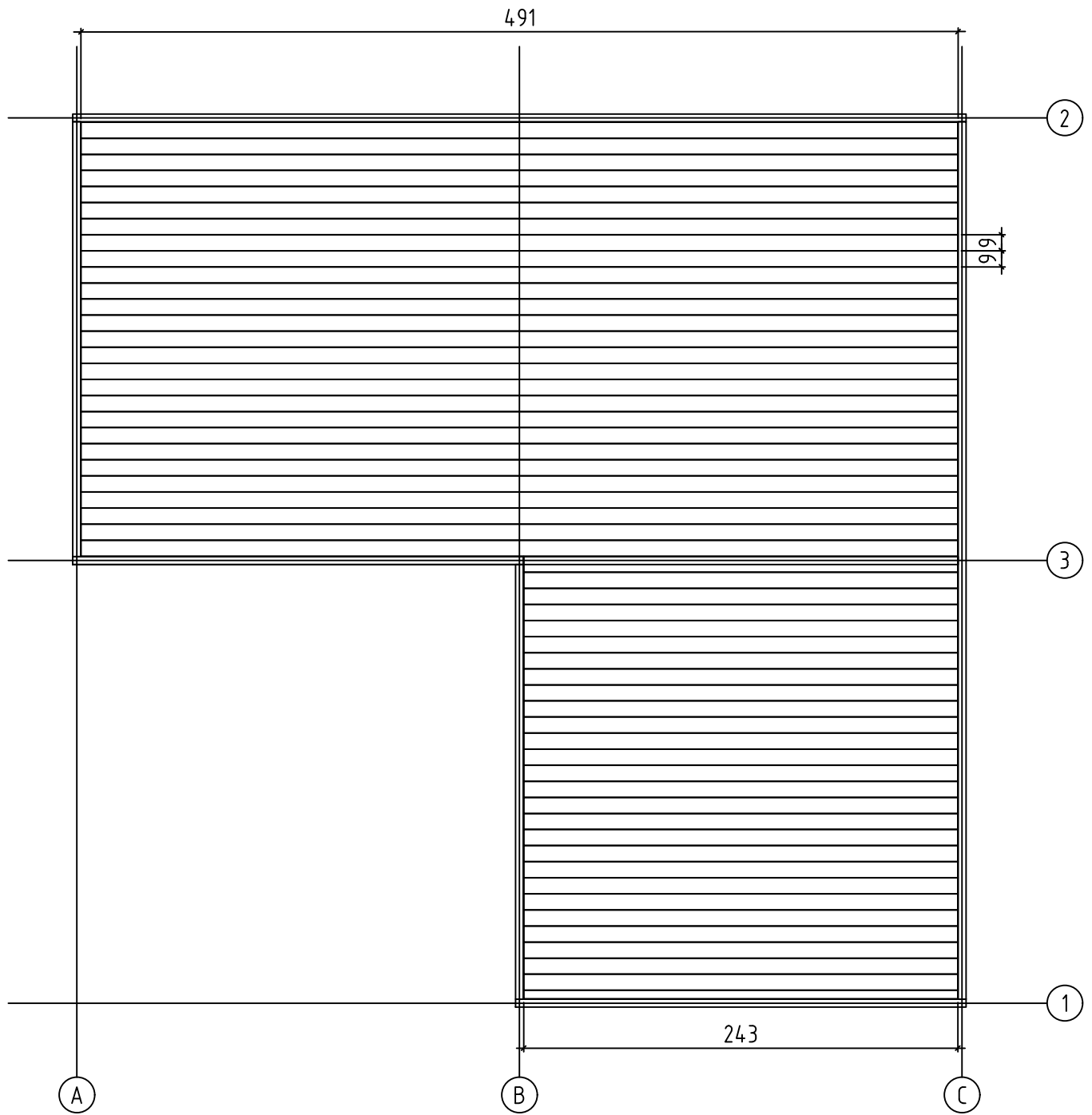

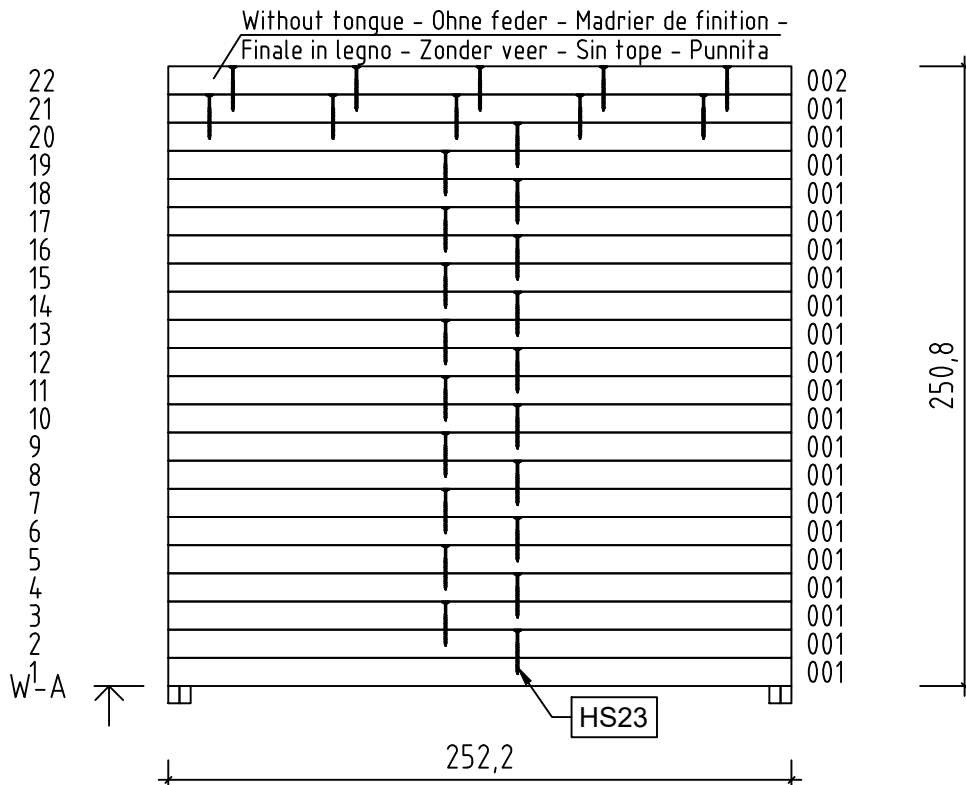
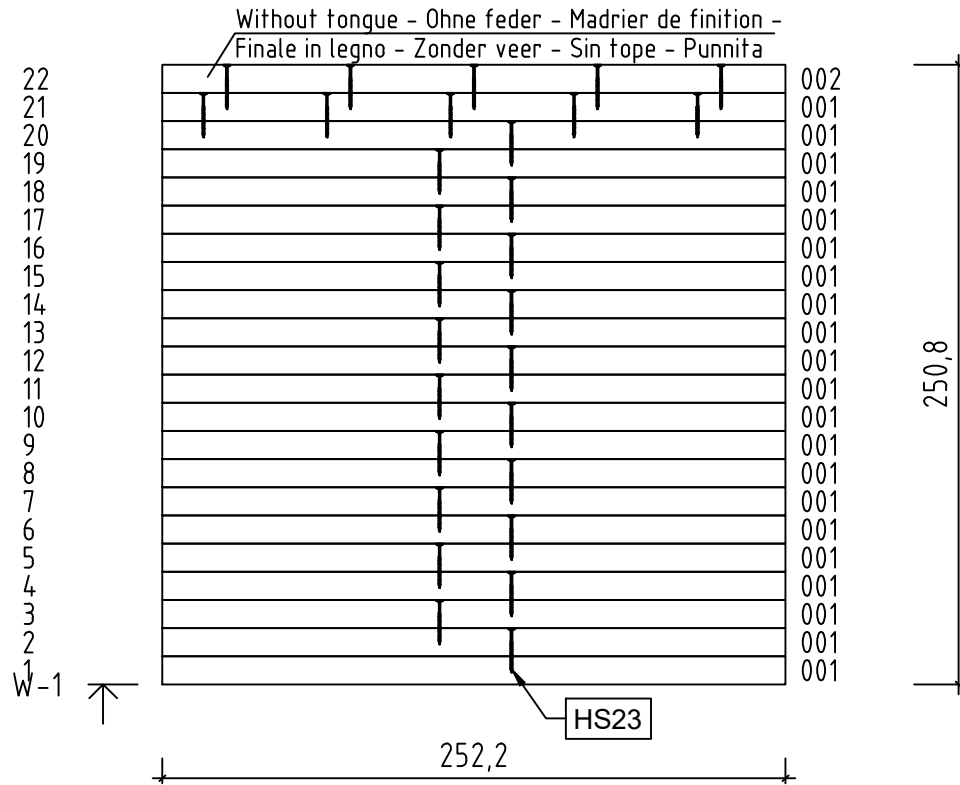

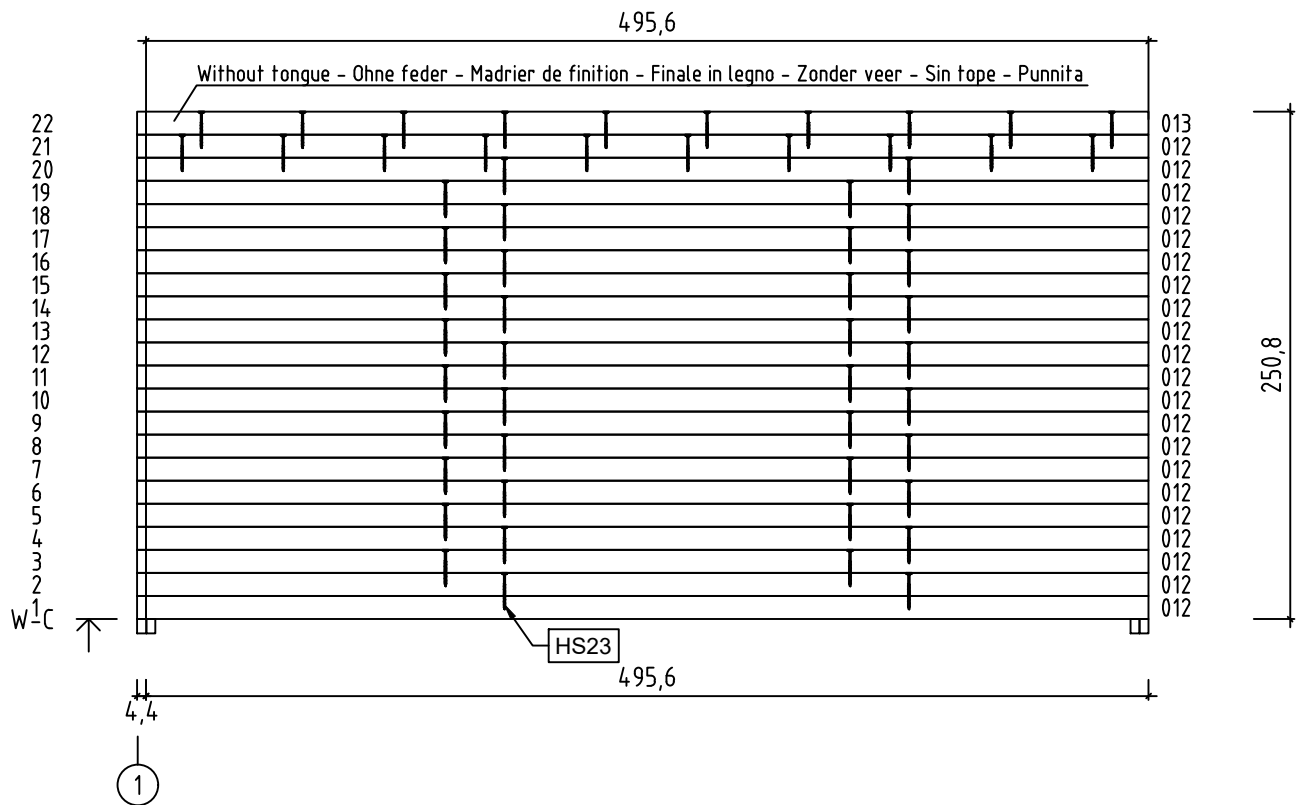
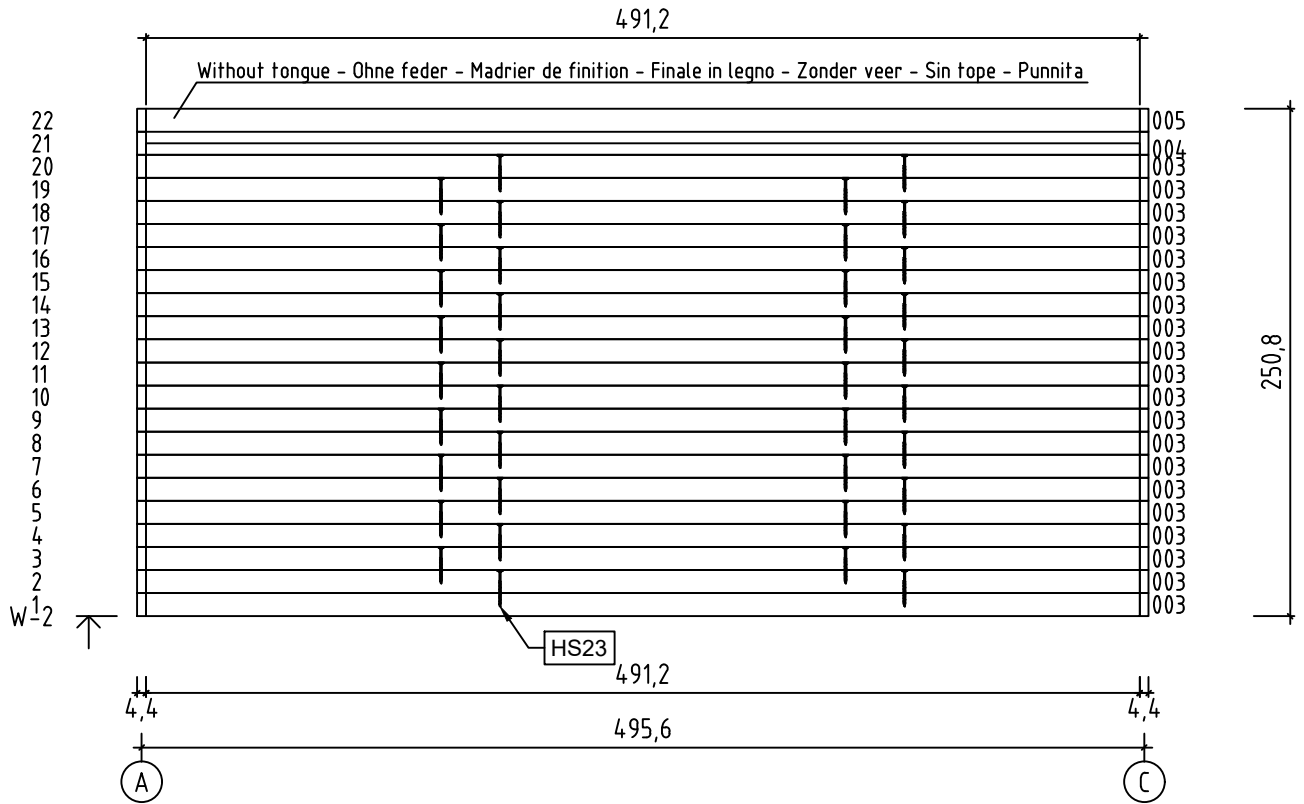

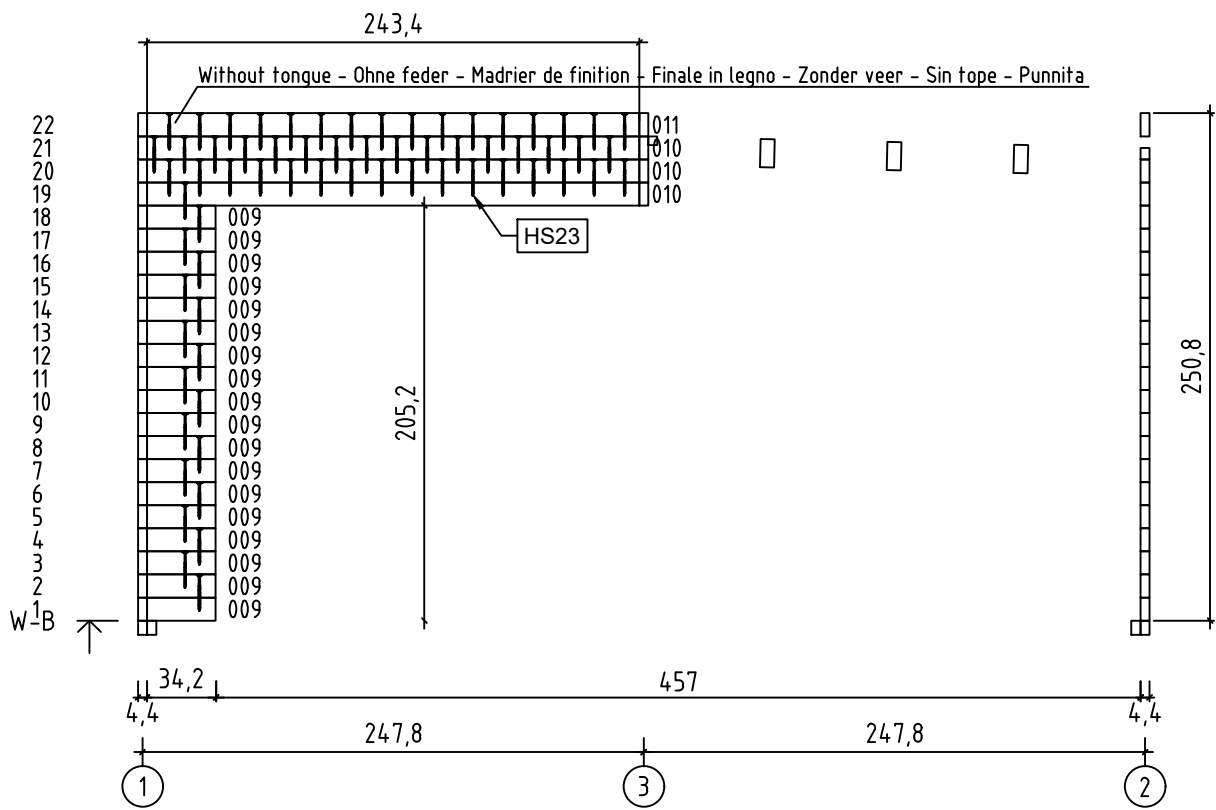
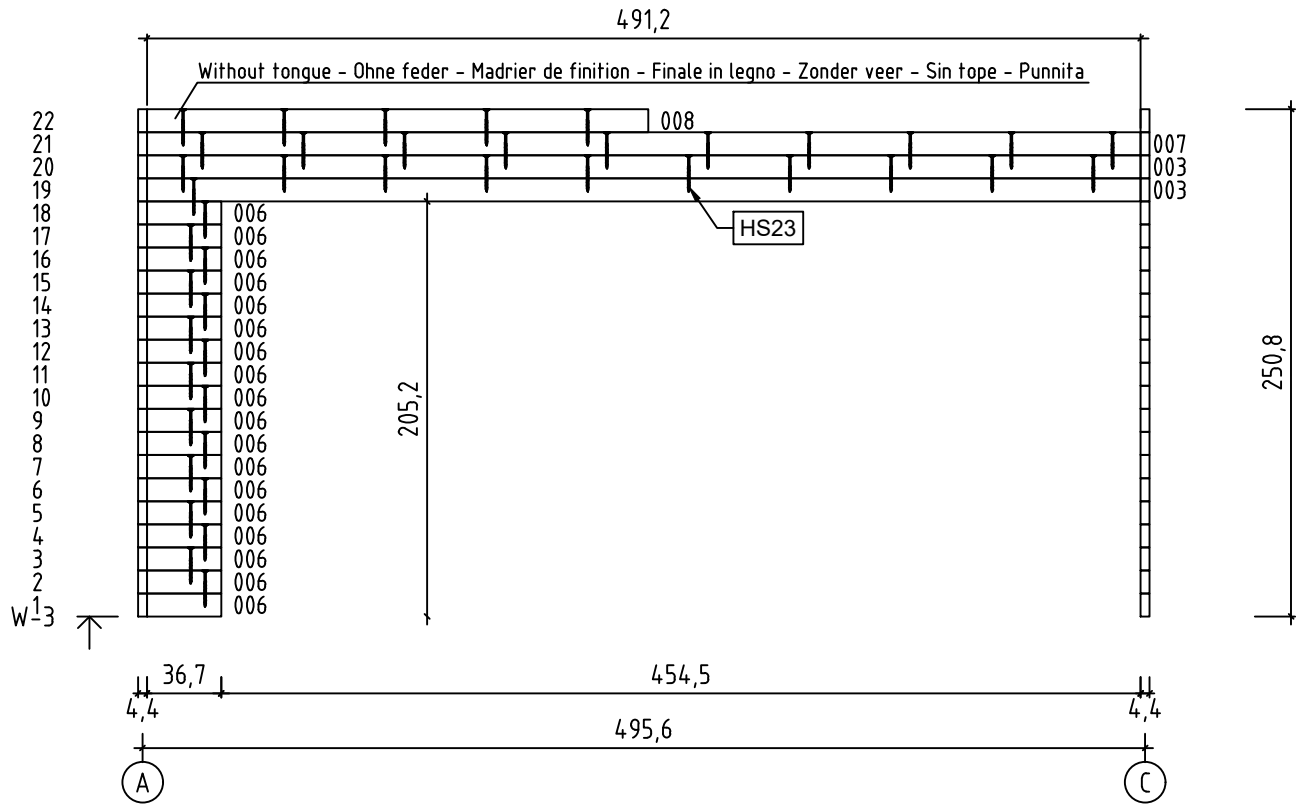

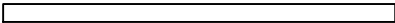
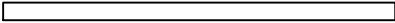
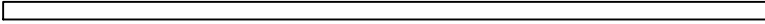





Floor boards - Fussbodenbretter - Plan pose plancher - Pavimento
- Vloerhout - Tarima de suelo - Põrandalaudis

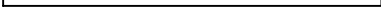

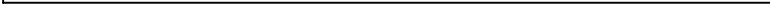

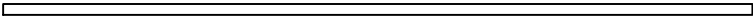
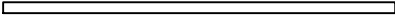
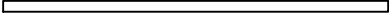
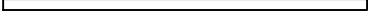

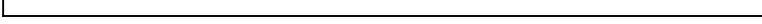
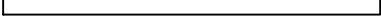

Pos	Piece list - Stückliste - Liste des pièces - Elementi - Stuklijst - Elementos - Tükítabel 02.08.2024 Art. Nr. 4424919 8/11	Q	P (mm)	L (mm)
001 26920		42	44x114	2522
002 39994		2	44x114	2522
003 25957		22	44x114	4912
004 40134		1	44x57	4912
005 39995		1	44x114	4912
006 49269		18	44x114	367
007 39995		1	44x114	4912
008 39998		1	44x114	2478
009 49286		18	44x114	339
010 24898		3	44x114	2434
011 24860		1	44x114	2434
012 38115		21	44x114	4956
013 38116		1	44x114	4956
IAR3 17913	Foundation - Fundament - Fondation - Fondamenta - Fundering - Bastidor - Immutatud alusraam 	2	45x70	5000
IAR2 39908	Foundation - Fundament - Fondation - Fondamenta - Fundering - Bastidor - Immutatud alusraam 	7	45x70	4820
IAR5 39909	Foundation - Fundament - Fondation - Fondamenta - Fundering - Bastidor - Immutatud alusraam 	2	45x70	2522
IAR4 24919	Foundation - Fundament - Fondation - Fondamenta - Fundering - Bastidor - Immutatud alusraam 	2	45x70	2478
IAR1 39910	Foundation - Fundament - Fondation - Fondamenta - Fundering - Bastidor - Immutatud alusraam 	5	45x70	2342
RV1 40001	Lath - Pfetten - Liteau - Piccola asse - Gordingen - Vigueta - Roov 	1	44x44	4798
RV2 40002	Lath - Pfetten - Liteau - Piccola asse - Gordingen - Vigueta - Roov 	1	44x44	2294
A-PR1 40003	Roof beam - Dachbalken - Panne de toit - Perlina del tetto - Gordingen / dakbalk - Correa - Pärlin 	3	70x140	4904
A-PR2 40004	Roof beam - Dachbalken - Panne de toit - Perlina del tetto - Gordingen / dakbalk - Correa - Pärlin 	3	70x140	2426
FB1 26895	Floor boards - Fussbodenbretter - Lame de plancher - Pavimento - Vloerhout - Tablero de suelo - Põrandalaud 	27	90x18.5	4908

Pos	Piece list - Stückliste - Liste des pièces - Elementi - Stuklijst - Elementos - Tükítabel 02.08.2024 Art. Nr. 4424919 9/11	Q	P (mm)	L (mm)
FB2 26896	Floor boards - Fussbodenbretter - Lame de plancher - Pavimento - Vloerhout - Tablero de suelo - Põrandalaud 	28	90x18.5	2430
DB1 4005	Roof boards - Dachbretter - Voliges - Perlina per tetto - Dakhout - Tablero de tejado - Katuselaud 	55+1	90x18.5	2571
DB2 4006	Roof boards - Dachbretter - Voliges - Perlina per tetto - Dakhout - Tablero de tejado - Katuselaud 	28+1	90x18.5	2479
30087	Floor fillet - Fussbodenleiste - Corniere de finition du plancher - Finitura per pavimento (battisco pa) - Vloerafwerkljst - Rodapié - Põrandaliist 		18x18	20
DPL1 26903	Roofing felt fillet - Dachpappenleiste - Baguette de fixation du feutre bitumeux - Asse per fissaggio guaina bituminosa - Afdeklijst asfaltpapier - Moldura de fieltro para tejado - Katusepapiliist 	1	18x58	2420
DPL2 26902	Roofing felt fillet - Dachpappenleiste - Baguette de fixation du feutre bitumeux - Asse per fissaggio guaina bituminosa - Afdeklijst asfaltpapier - Moldura de fieltro para tejado - Katusepapiliist 	1	18x58	2536
DPL3 40008	Roofing felt fillet - Dachpappenleiste - Baguette de fixation du feutre bitumeux - Asse per fissaggio guaina bituminosa - Afdeklijst asfaltpapier - Moldura de fieltro para tejado - Katusepapiliist 	1	18x58	2594
DPL4 40009	Roofing felt fillet - Dachpappenleiste - Baguette de fixation du feutre bitumeux - Asse per fissaggio guaina bituminosa - Afdeklijst asfaltpapier - Moldura de fieltro para tejado - Katusepapiliist 	2	18x58	2602
DPL5 39158	Roofing felt fillet - Dachpappenleiste - Baguette de fixation du feutre bitumeux - Asse per fissaggio guaina bituminosa - Afdeklijst asfaltpapier - Moldura de fieltro para tejado - Katusepapiliist 	1	18x58	2718
FL1 40011	Fillet - Leiste - Lattes - Massellino di guarnizione per ringhiera - Lijst - Moldura triangular - Liist 	1	28x34	342
FL2 40044	Support block - Stützblock - Bloc de support - Blocco di supporto - Ondersteuningsblok - Bloque de soporte - Tugiklots 	2	44x44	330
P1 40035	Post - Pfosten - Poteau - Piede registrabile - Stijl - Poste - Post 	2	70x70	2337
P2 40036	Post - Pfosten - Poteau - Piede registrabile - Stijl - Poste - Post 	1	70x70	2394
P3 40037	Post - Pfosten - Poteau - Piede registrabile - Stijl - Poste - Post 	2	70x70	2452
P4 40038	Post - Pfosten - Poteau - Piede registrabile - Stijl - Poste - Post 	1	90x90	2052
P5 47116	Post - Pfosten - Poteau - Piede registrabile - Stijl - Poste - Post 	1	88x88	2052
P6 48275	Post - Pfosten - Poteau - Piede registrabile - Stijl - Poste - Post 	1	88x88	2052
FF1 48861	Fixing fillet - Fixierungsleiste - Profil de fixation - Massello di fissaggio - Bevestiging lijstwerk - Moldura en T - Tenderliis 	1	88x88	2111
FF2 48862	Fixing fillet - Fixierungsleiste - Profil de fixation - Massello di fissaggio - Bevestiging lijstwerk - Moldura en T - Tenderliis 	1	88x88	2111
DRV1 40039	Roof edge reinforcement - Dachrandverstärkung - Corniere de renfort de bord de toit - Rinforzo x tetto - Dakrand versterking - Refuerzo de aleros - Räästatugevdus 	1	80x44	2398
DRV2 40040	Roof edge reinforcement - Dachrandverstärkung - Corniere de renfort de bord de toit - Rinforzo x tetto - Dakrand versterking - Refuerzo de aleros - Räästatugevdus 	2	80x44	2478
DRV3 40042	Roof edge reinforcement - Dachrandverstärkung - Corniere de renfort de bord de toit - Rinforzo x tetto - Dakrand versterking - Refuerzo de aleros - Räästatugevdus 	1	80x44	2558
DRV4 40043	Roof edge reinforcement - Dachrandverstärkung - Corniere de renfort de bord de toit - Rinforzo x tetto - Dakrand versterking - Refuerzo de aleros - Räästatugevdus 	4	80x44	2602

Pos	Piece list - Stückliste - Liste des pièces - Elementi - Stuklijst - Elementos - Tükítabel 02.08.2024 Art. Nr. 4424919 10/11	Q	P (mm)	L (mm)
RS1 49136	Batten - Deckleiste - Profils de finition angles a l'exterieur - Asse - Afdek lijst -  Moldura de recubrimiento - Tuulelaud	2	18x90	1990
RS2 37814	Batten - Deckleiste - Profils de finition angles a l'exterieur - Asse - Afdek lijst -  Moldura de recubrimiento - Tuulelaud	2	18x90	2126
GL1 26908	Gable moulding - Giebelleiste - Planche de rive - Finitura per frontale e retro del tetto - Gevellijst - Tablero de frontón - Viilulaud 	2	18x120	2478
GL2 40045	Gable moulding - Giebelleiste - Planche de rive - Finitura per frontale e retro del tetto - Gevellijst - Tablero de frontón - Viilulaud 	2	18x120	2580
GL3 40046	Gable moulding - Giebelleiste - Planche de rive - Finitura per frontale e retro del tetto - Gevellijst - Tablero de frontón - Viilulaud 	2	18x120	2598
GL4 40047	Gable moulding - Giebelleiste - Planche de rive - Finitura per frontale e retro del tetto - Gevellijst - Tablero de frontón - Viilulaud 	1	18x120	2682
GL5 40048	Gable moulding - Giebelleiste - Planche de rive - Finitura per frontale e retro del tetto - Gevellijst - Tablero de frontón - Viilulaud 	1	18x120	2718
HS12 5109	Screw for metal corner - Holzschraube für metallwinkel - Vis de fixation des cornieres en métal - Viti per fissare suadretta di metallo di giunzione - Schroef voor metalen hoek - Tornillo para escuadra - Kruvi nurgikule 	20	4x40	
HS12 5109	Screw for beam holder - Schrauben für balkenhalter - Vis de fixation support "u" galvanisé - Vite per trave di sostegno - Schroef voor bevestiging balkhouder (gordingschoen) - Tornillo para zapata de viga - Kruvi talakingale 	144	4x40	
HS12 5109	Screw for covering moulding - Schrauben für deckungsprofil - Vis de fixation profils horizontaux haut intérieur et extérieur d'encadrement de porte - Vite per cornice di copertura - Schroef voor afdekprofiel - Tornillo para tablero delimitador - Kruvi tuulelauale 	16	4x40	
HS12 5109	Screw for door jamb - Schraube für türrahmen - Vis de fixation partie haute avec montants du cadre de porte - Viti x fissaggio montanti porte - Schroef voor deurkozijn - Tornillo para jamba de puerta - Kruvi ukse lengile 	8	4x40	
HS12 5109	Screw for gable moulding - Schrauben für giebelleiste - Vis pour fixation planche de rive - Vite per fissare finiture davanti e dietro del tetto - Schroef voor gevellijst - Tornillo para tablero de frontón - Kruvi viilulauale 	48	4x40	
HS13 5110	Screw for wall details - Schraube für wand details - Vis pour mur details - Viti per elementi della porta - Schroef voor wand details - Tornillo para elemento de pared - Kruvi seinadetailile 	36	4x60	
HS13 5110	Screw for door jamb - Schraube für türrahmen - Vis de fixation partie haute avec montants du cadre de porte - Viti x fissaggio montanti porte - Schroef voor deurkozijn - Tornillo para jamba de puerta - Kruvi ukse lengile 	18	4x60	
HS18 5113	Screw for post - Schrauben für pfosten - Vis de fixation des poteaux - Viti per inviare - Schroef voor stijlen - Tornillo para poste - Kruvi postile 	4	5x120	
HS34 40958	Screw for wall details - Schraube für wand details - Vis pour mur details - Viti per elementi della porta - Schroef voor wand details - Tornillo para elementos de pared - Kruvi seinadetailile 	460	5x80	
HS16 5115	Screw for foundation - Schrauben zur befestigung fundament - Vis de fixations des poutrelles de fondations - Viti x fundamenta - Schroef voor fundering - Tornillo para bastidor - Kruvi alusraamile 	44	5x90	
HS16 5115	Screw for post - Schrauben für pfosten - Vis de fixation des poteaux - Viti per inviare - Schroef voor stijlen - Tornillo para poste - Kruvi postile 	12	5x90	
HS16 5115	Screw for roof edge reinforcement - Schrauben für dachrandverstärkung - Vis pour fixation corniere renfort de bord de toit - Viti x rinforzo bordo tetto - Schroef voor dakrand versterking - Tornillo para refuerzo de alero - Kruvi räästatugevduusele 	40	5x90	
HS16 5115	Screw for wall details - Schraube für wand details - Vis pour mur details - Viti per elementi della porta - Schroef voor wand details - Tornillo para elementos de pared - Kruvi seinadetailidele 	10	5x90	
HS22 5120	Screw for 1. wall beam - Schraube für 1. bohlenreihe - Vis de fixations 1ere rangée de madrirs avec poutrelles de fondations - Vite fissaggio alle fundamenta - Schroef voor 1 wandbalk - Tornillo para medio tablero - Kruvi 1. seinareale 	12	6x150	
HS23 5121	Screw for wall details - Schraube für wand details - Vis pour mur details - Viti per elementi della porta - Schroef voor wand details - Tornillo para elementos de pared - Kruvi seinadetailidele 	270	6x180	
NF2 5127	Zn nail for floor fillet - Zn nagel für fussbodenteiste - Pointe pour corniere de finition du plancher - Chiodi x fissaggio pavimento - Spijker(nagel) voor vloer afdeklijst - Clavo para rodapié - Nael põrandaliistule 	40	1.4x40	

Art. Nr. 4424919

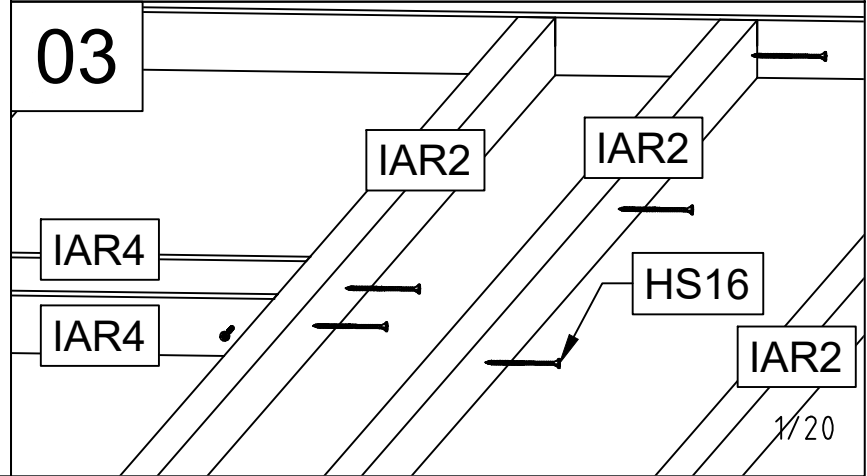
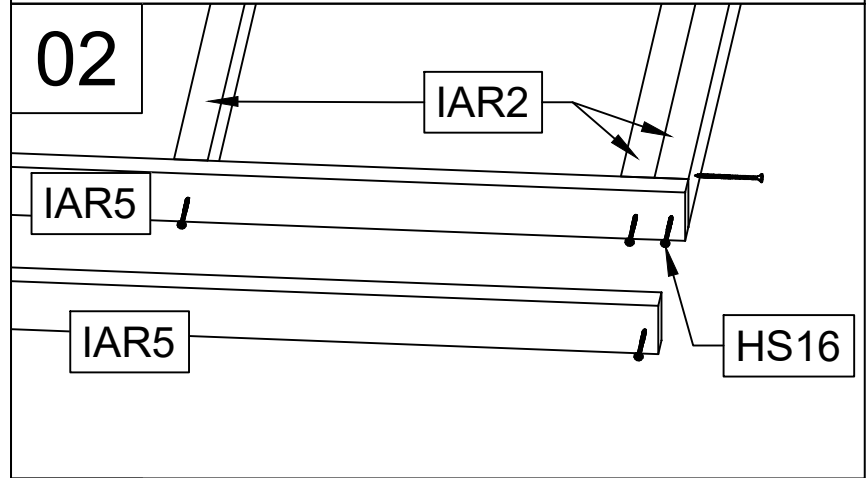
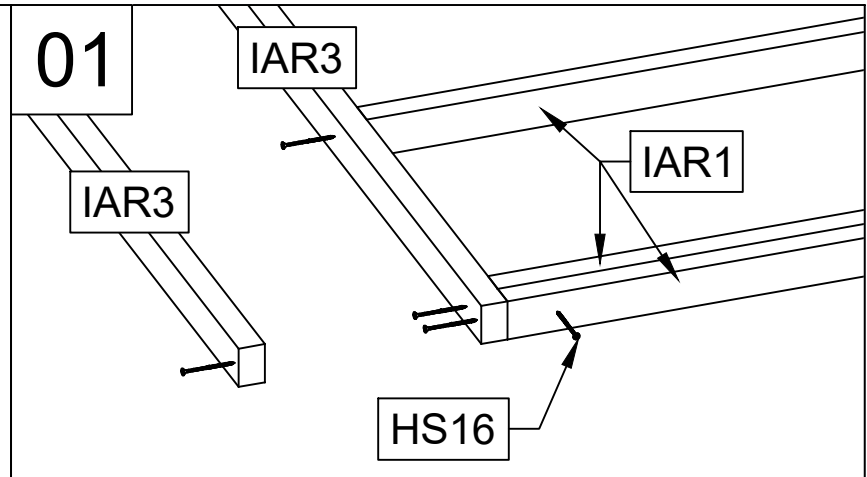
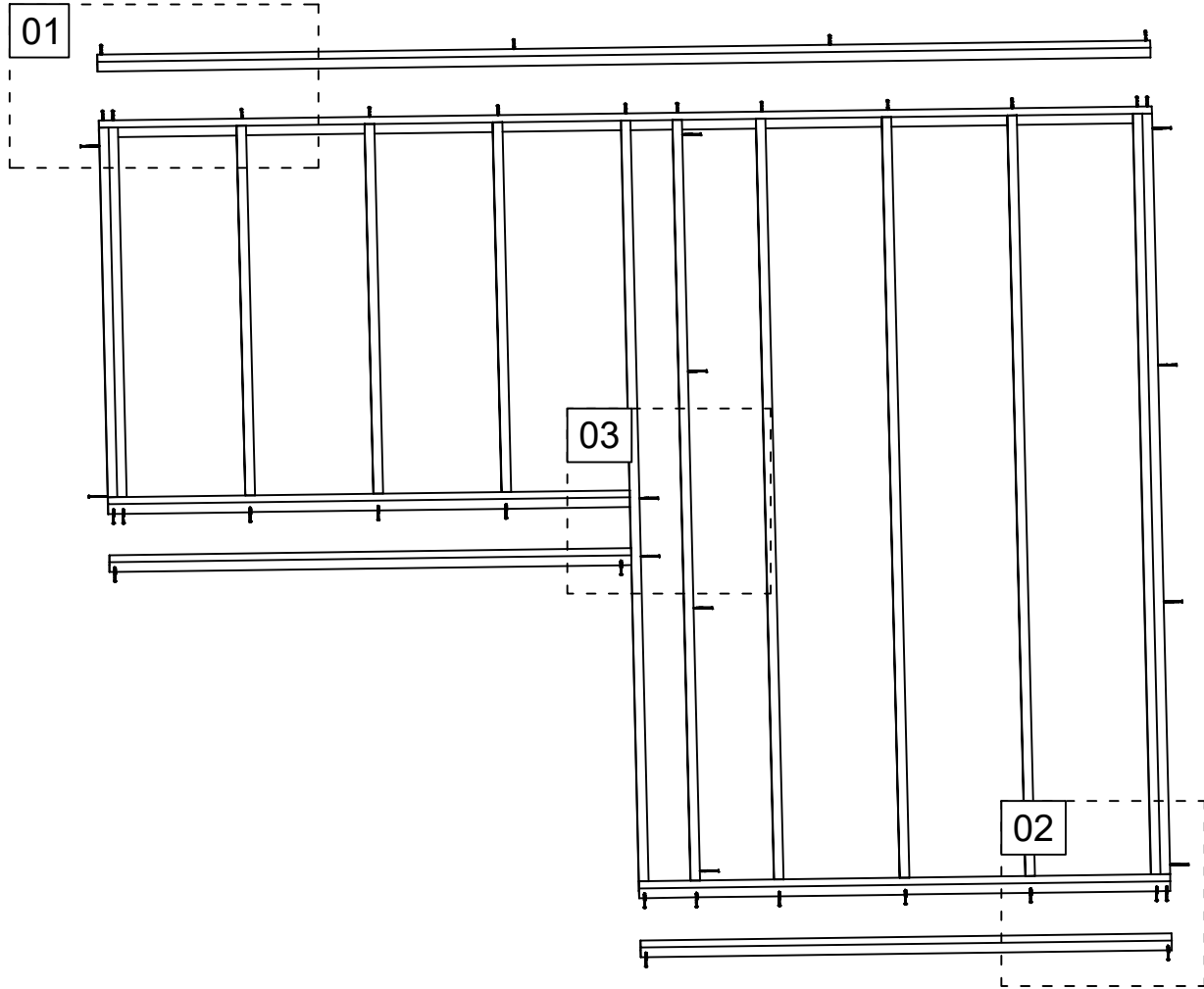

Art. Nr. 4424919

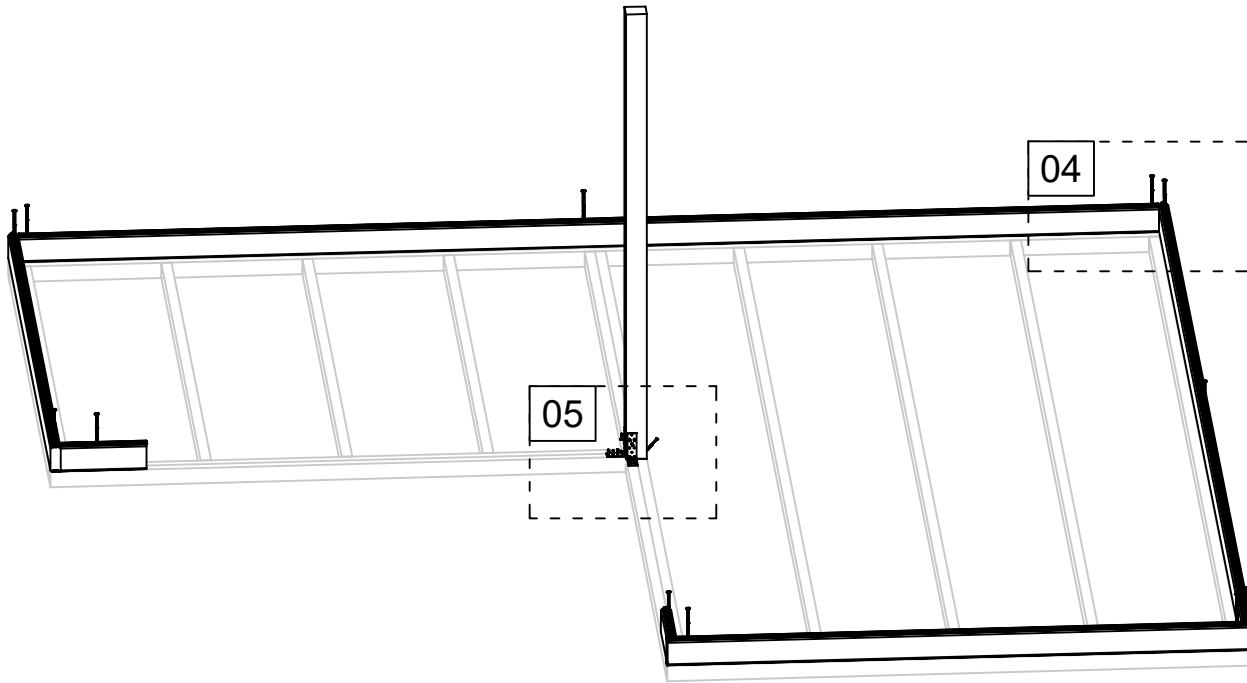

04

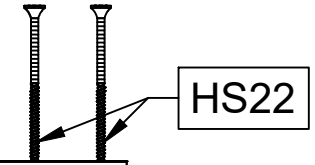

05

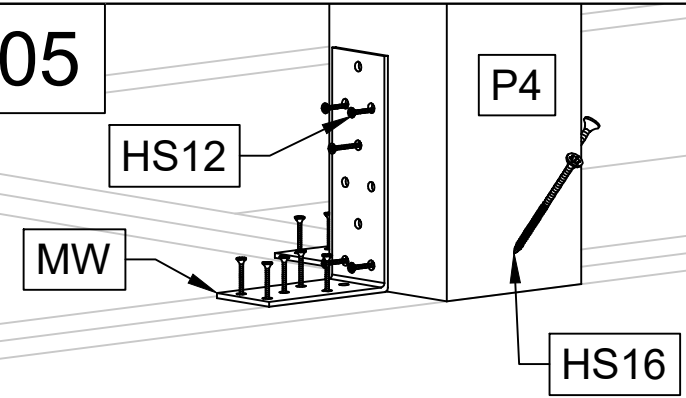

05

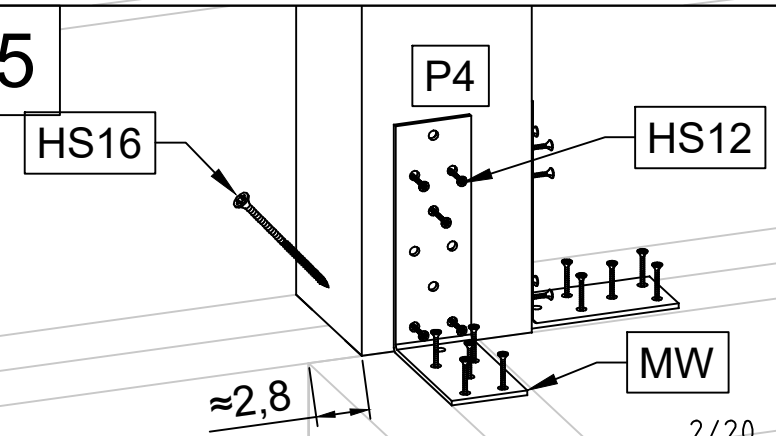

Art. Nr. 4424919

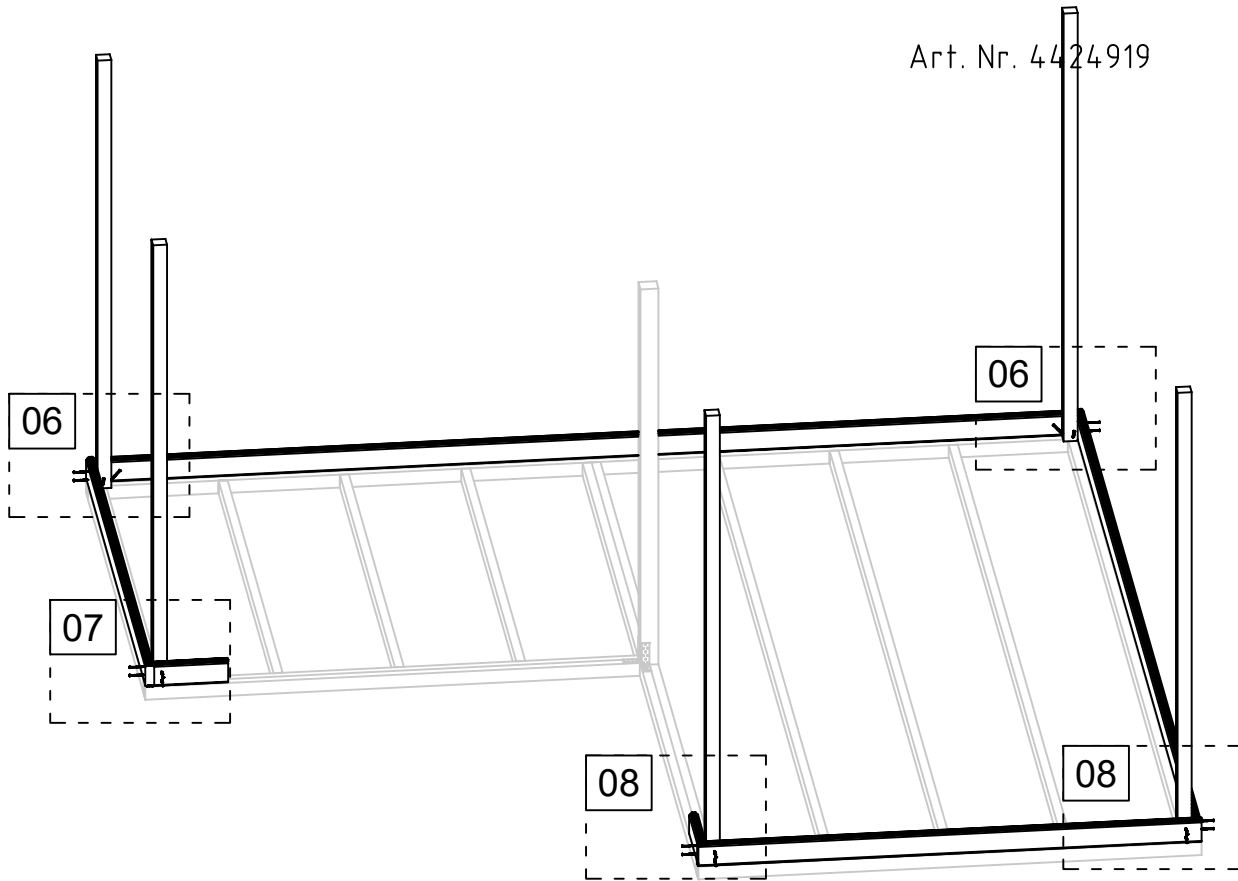

06

P1

HS16

07

P2

HS16

06/07/08

≈8 cm

≈8 cm

HS14

02.08.2024

06/07/08

8cm

8cm

HS14

3/20

Art. Nr. 4424919

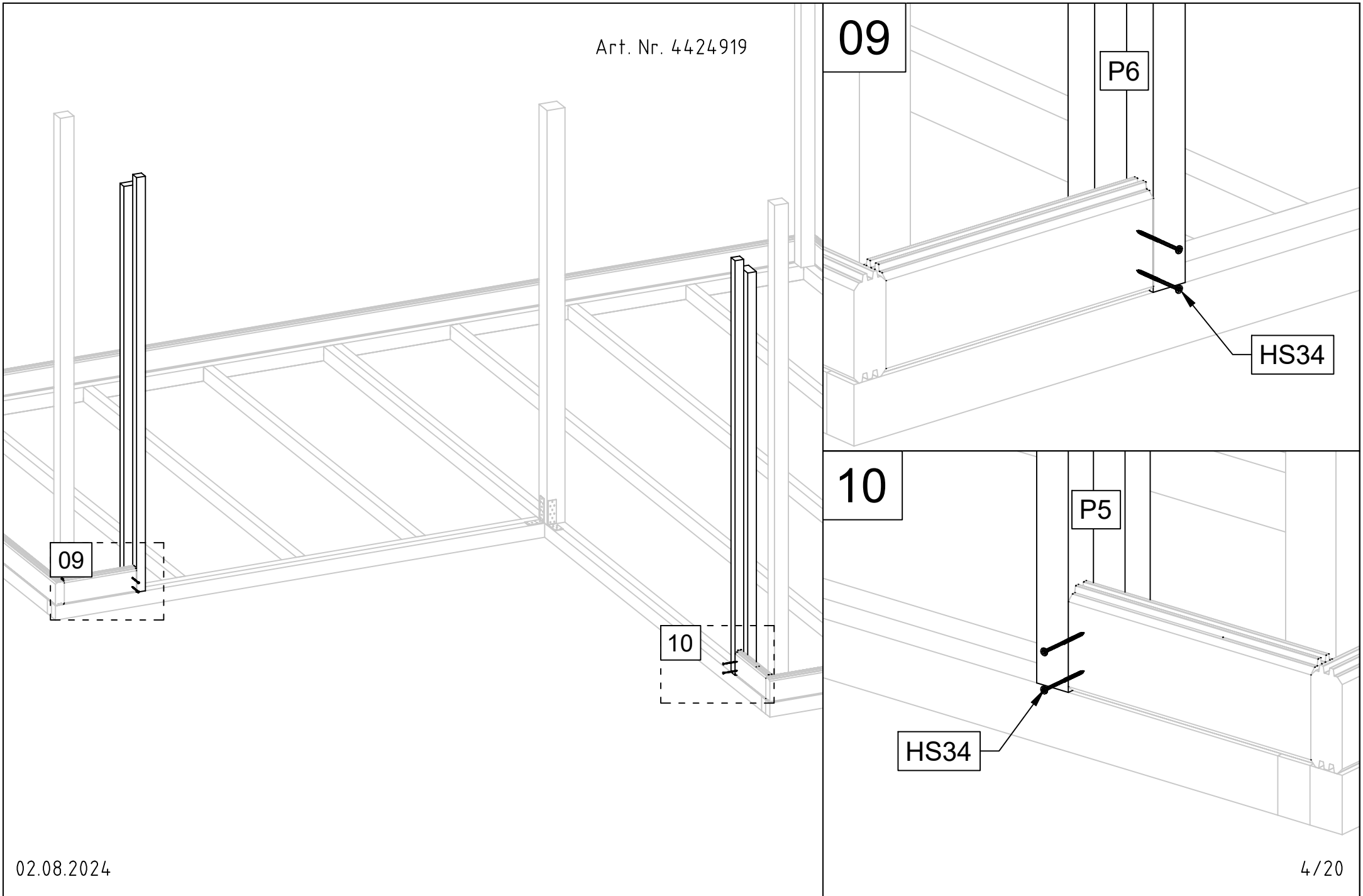

Art. Nr. 4424919

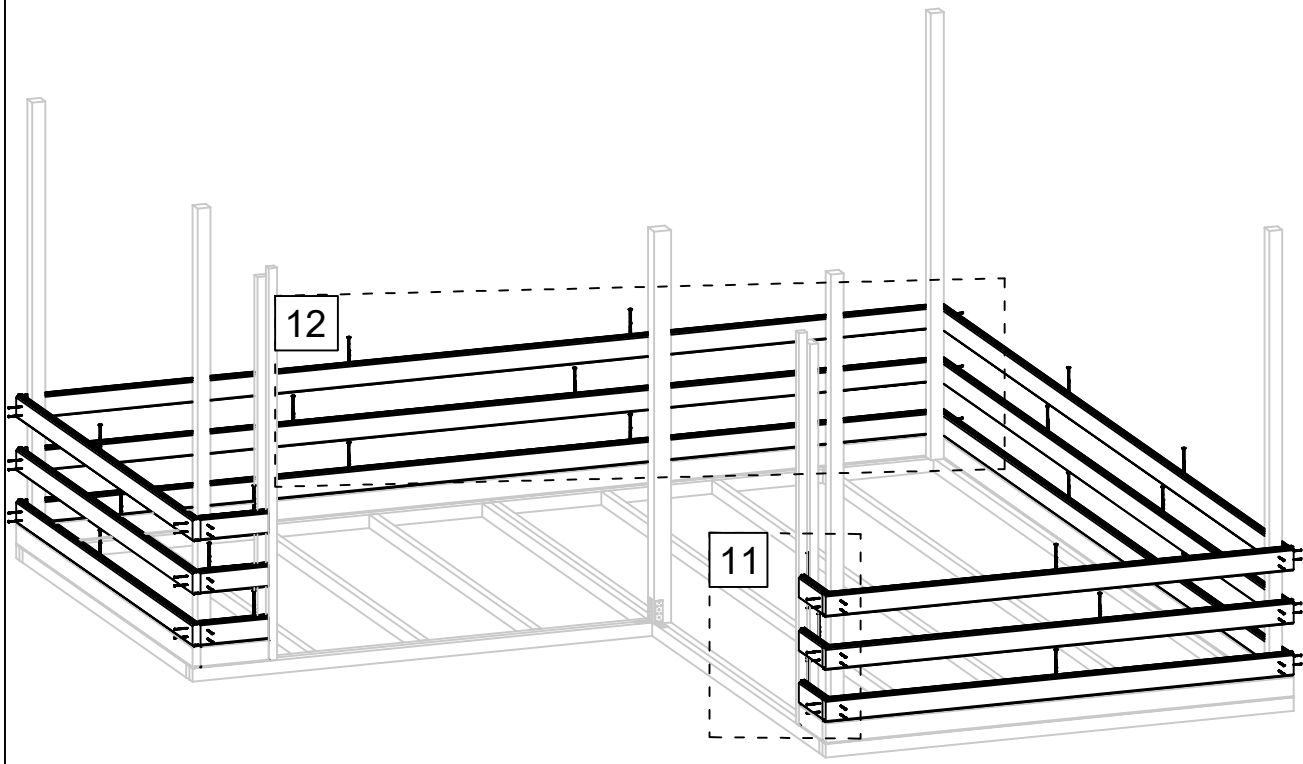

11

HS23

HS34

12

HS23

HS34

Art. Nr. 4424919

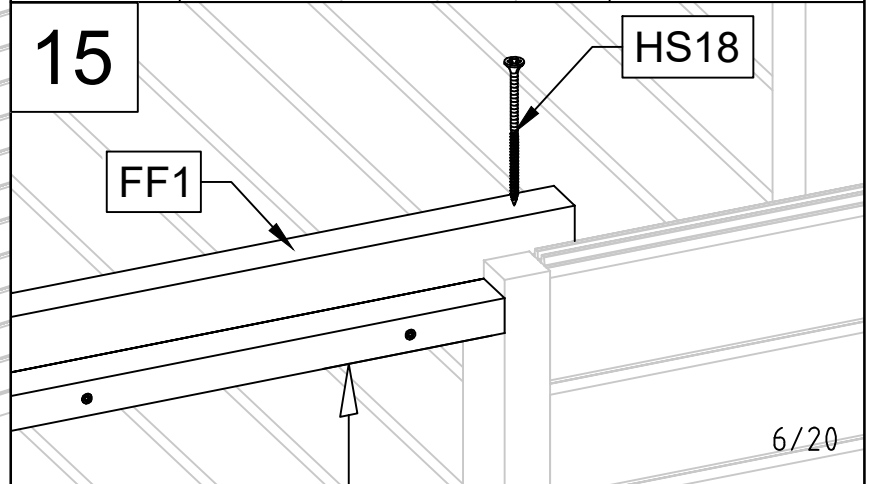
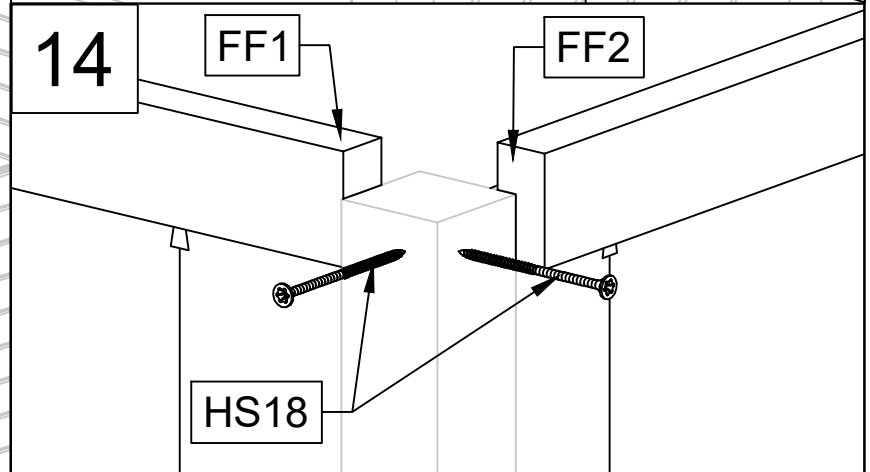
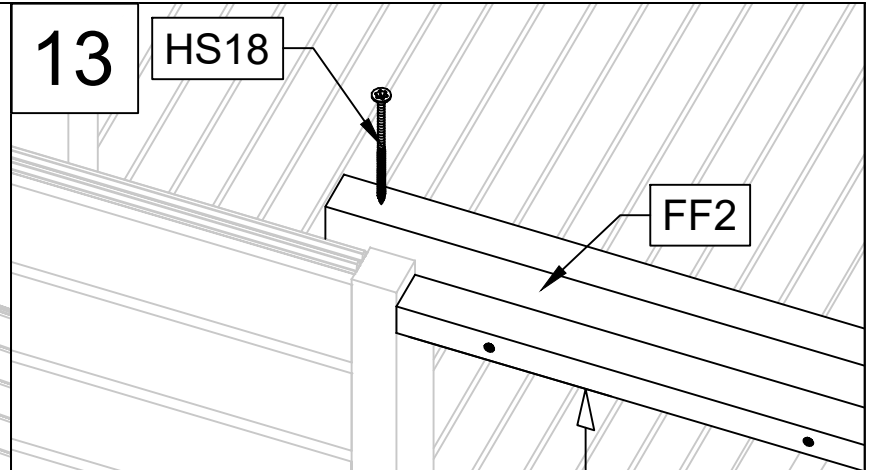
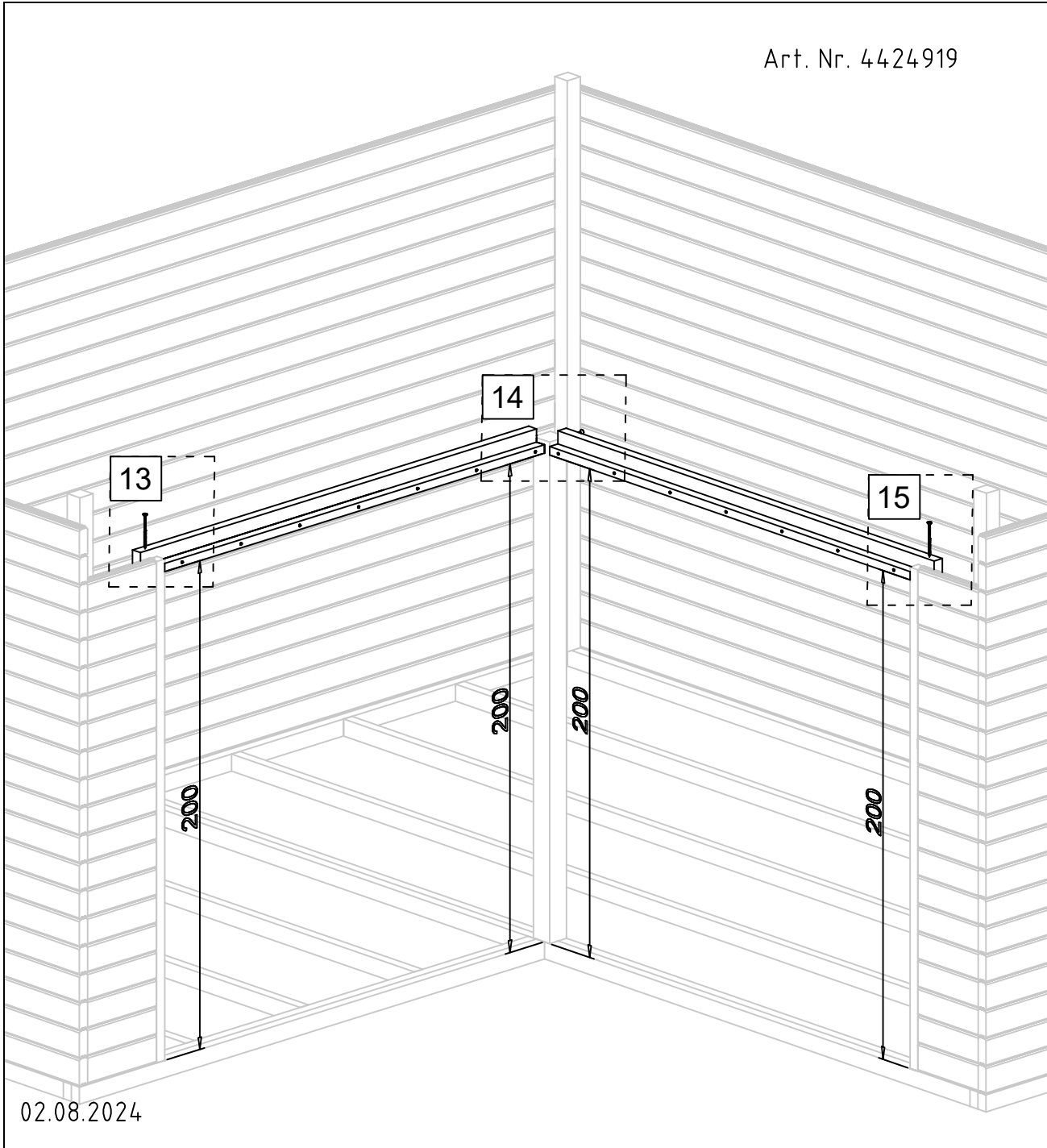

Art. Nr. 4424919

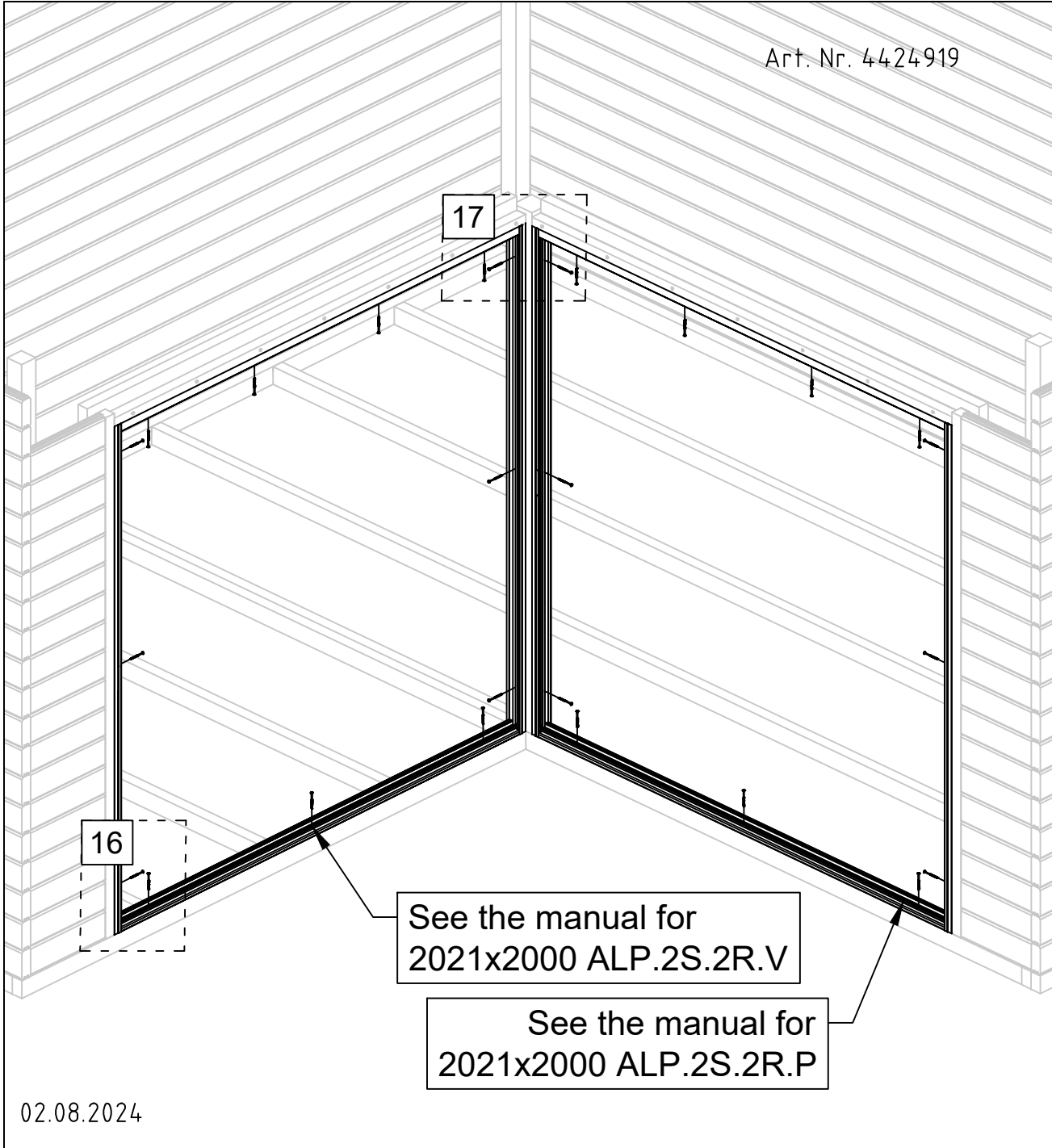

See the manual for
2021x2000 ALP.2S.2R.V

See the manual for
2021x2000 ALP.2S.2R.P

02.08.2024

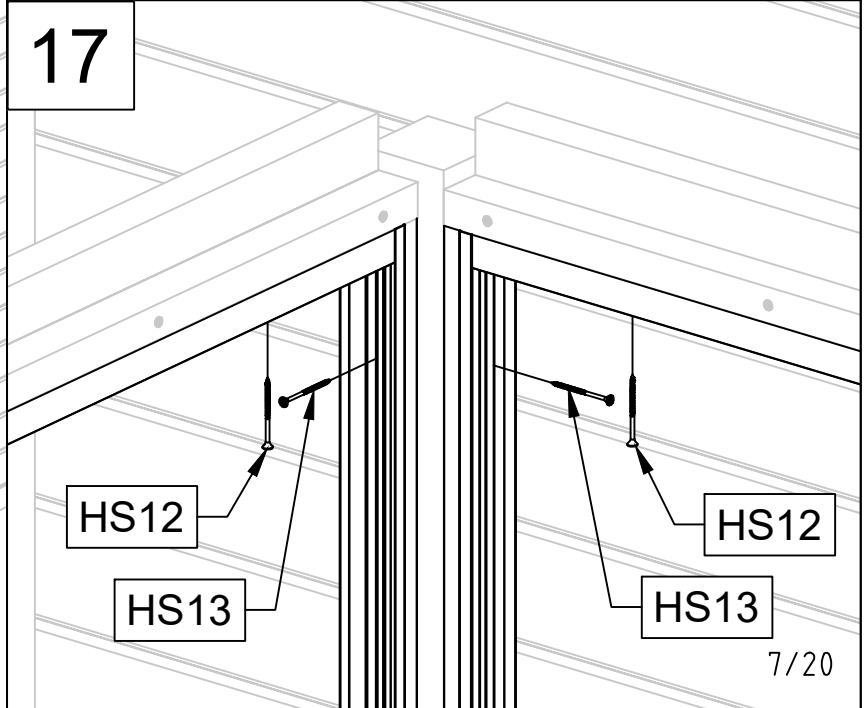
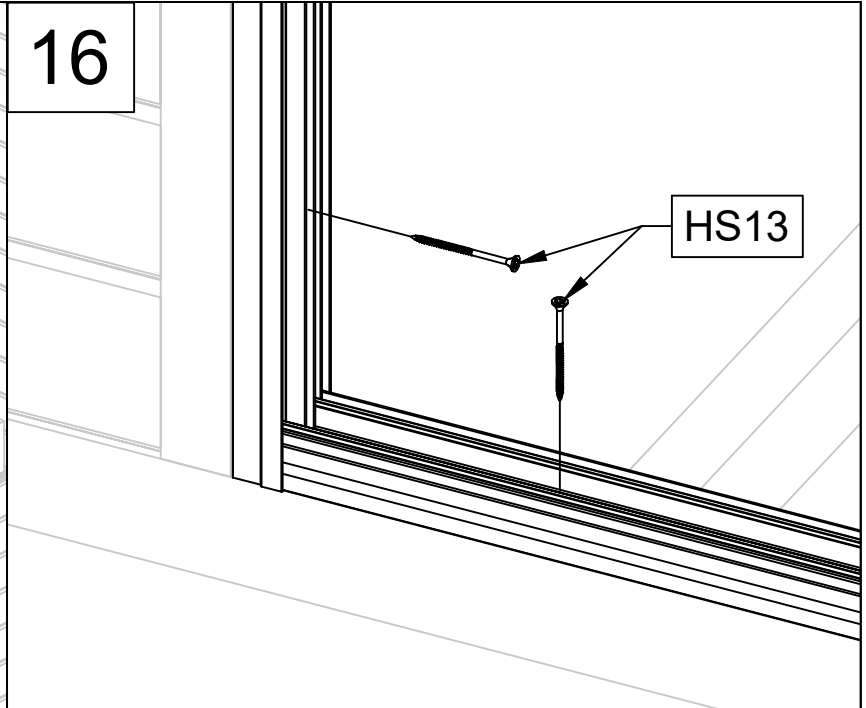

7/20

Art. Nr. 4424919

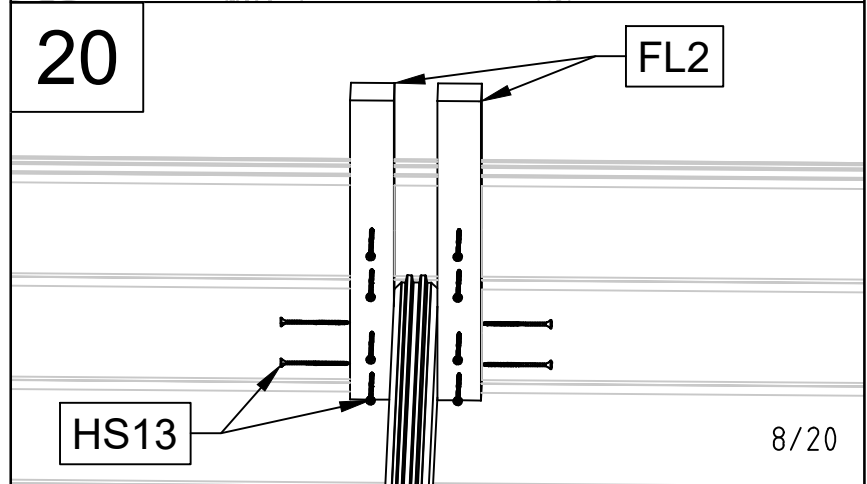
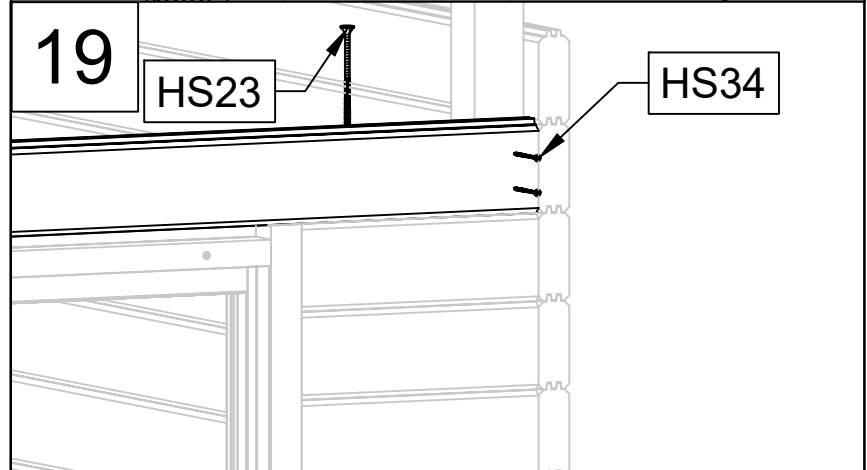
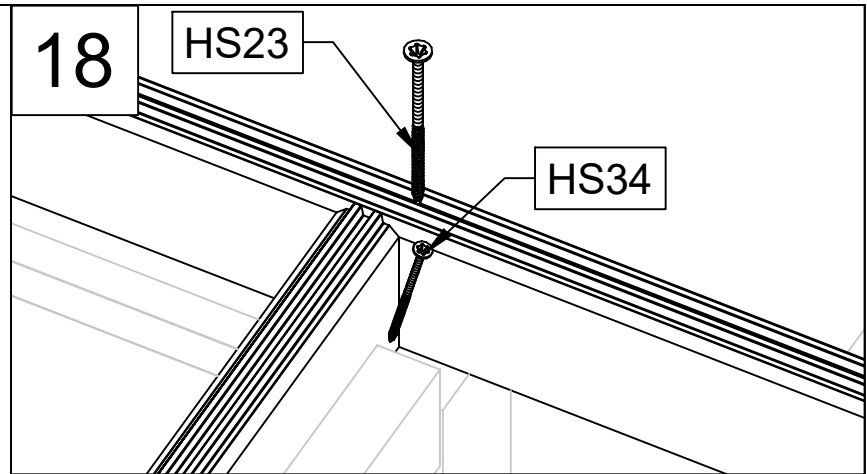
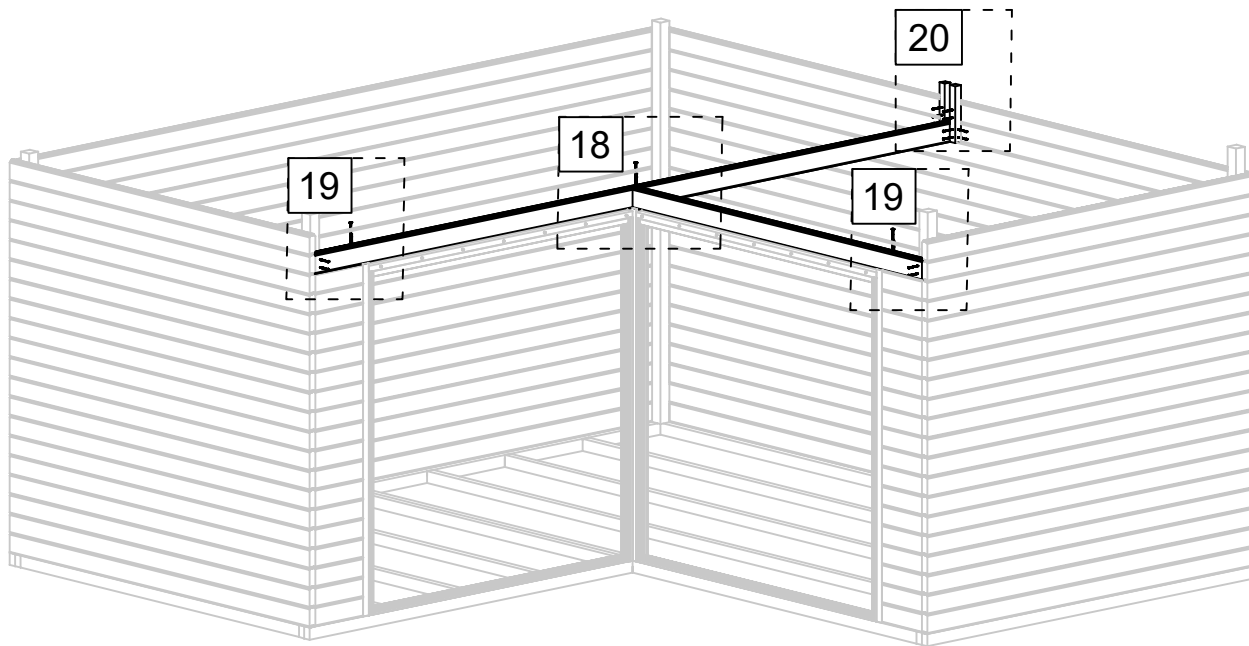

Art. Nr. 4424919

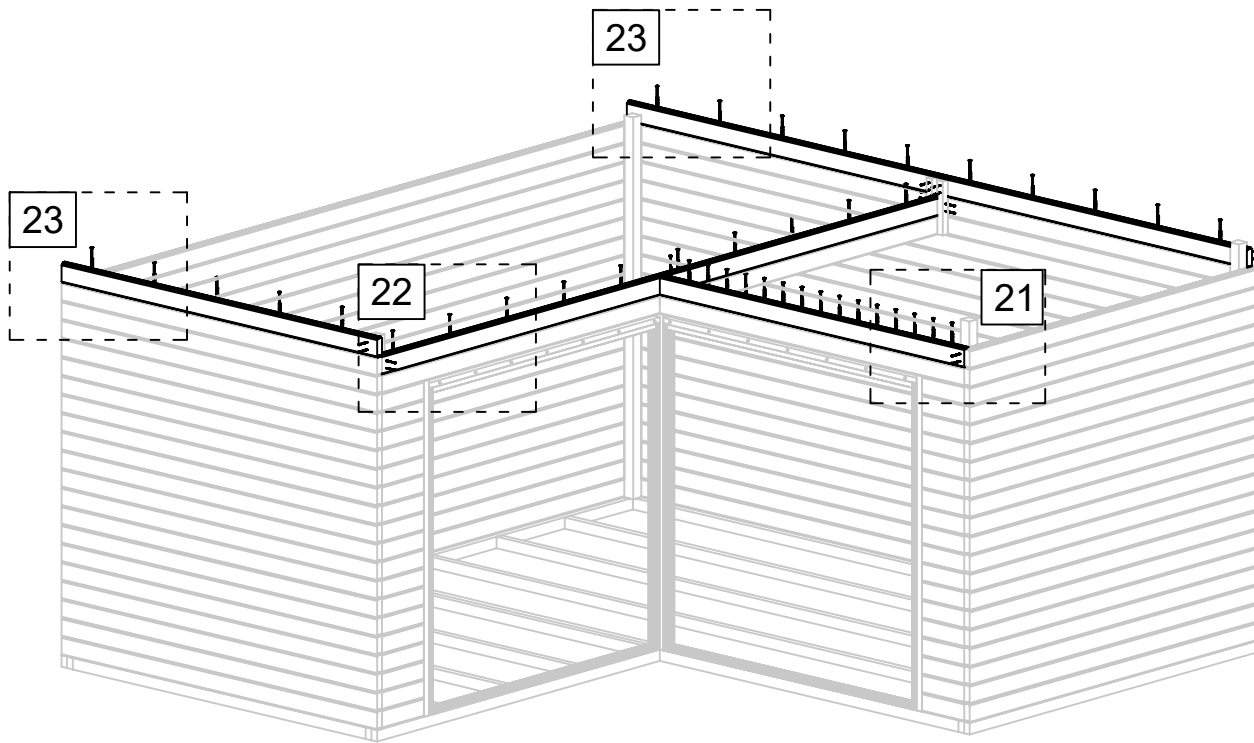

21

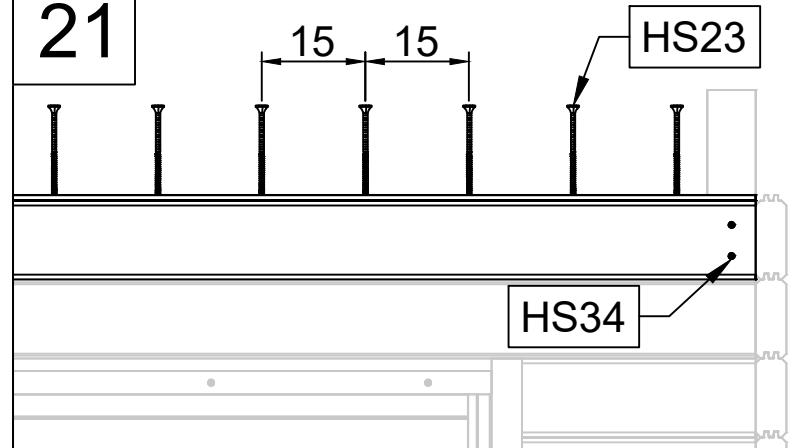

22

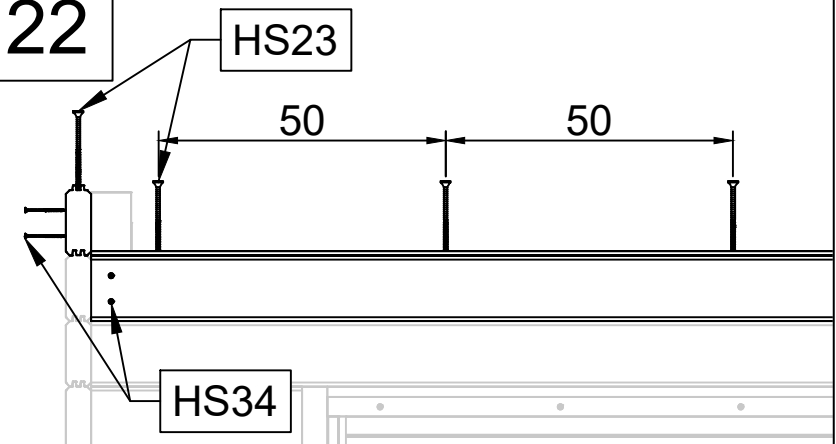

23

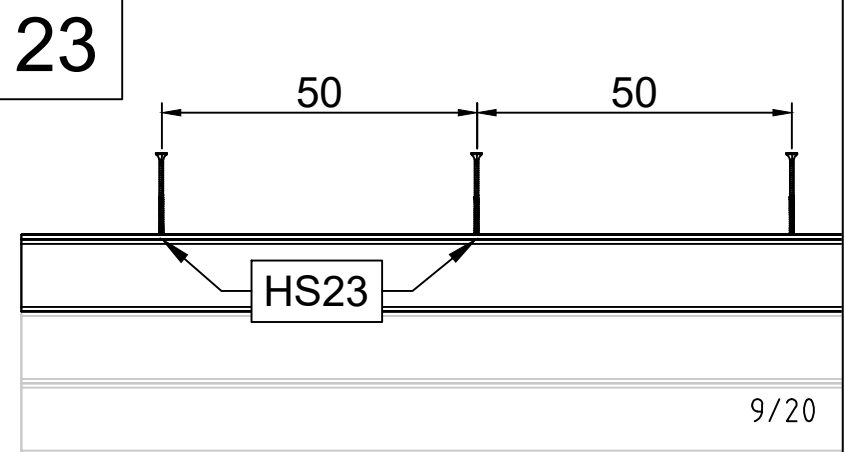

Art. Nr. 4424919

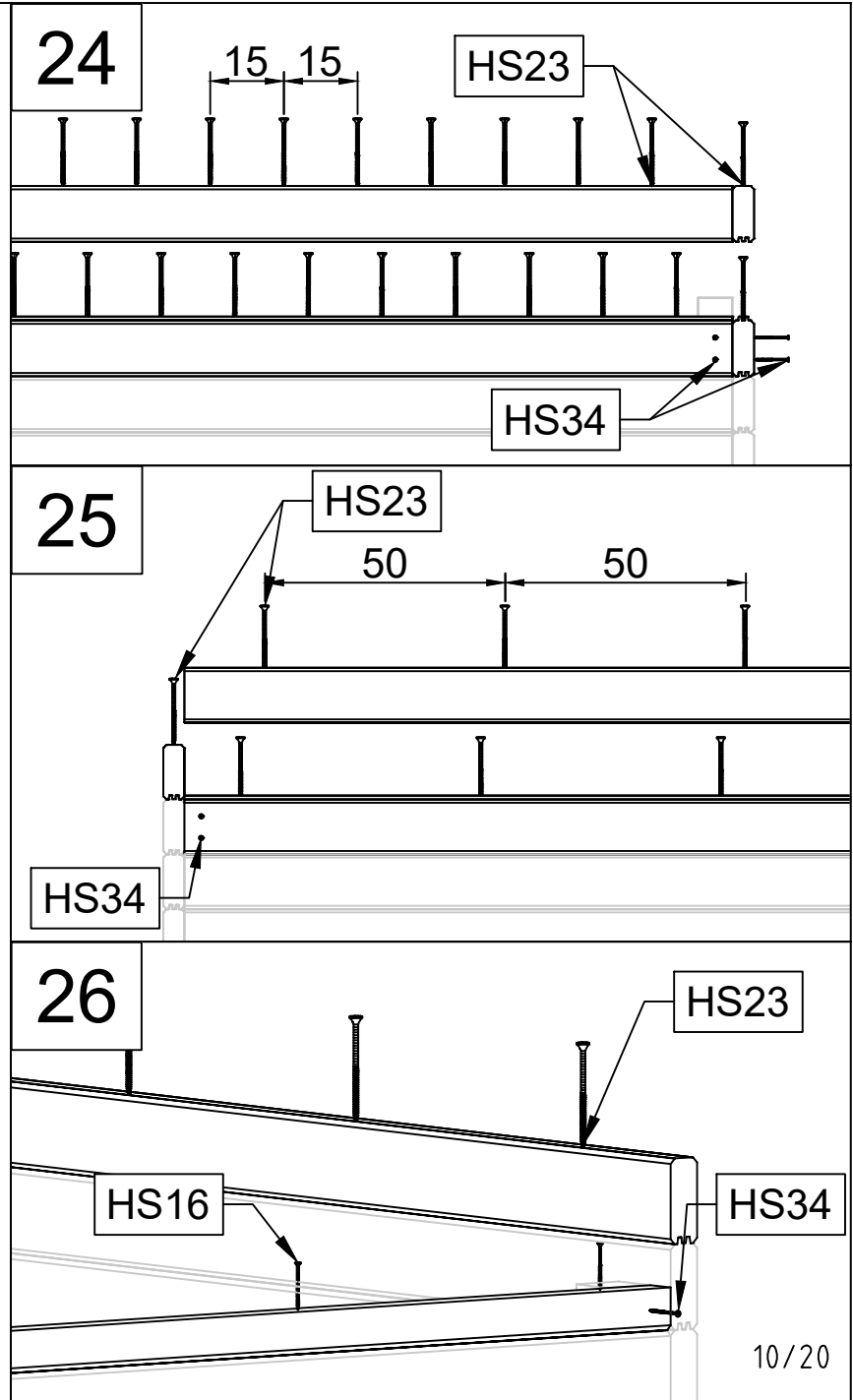
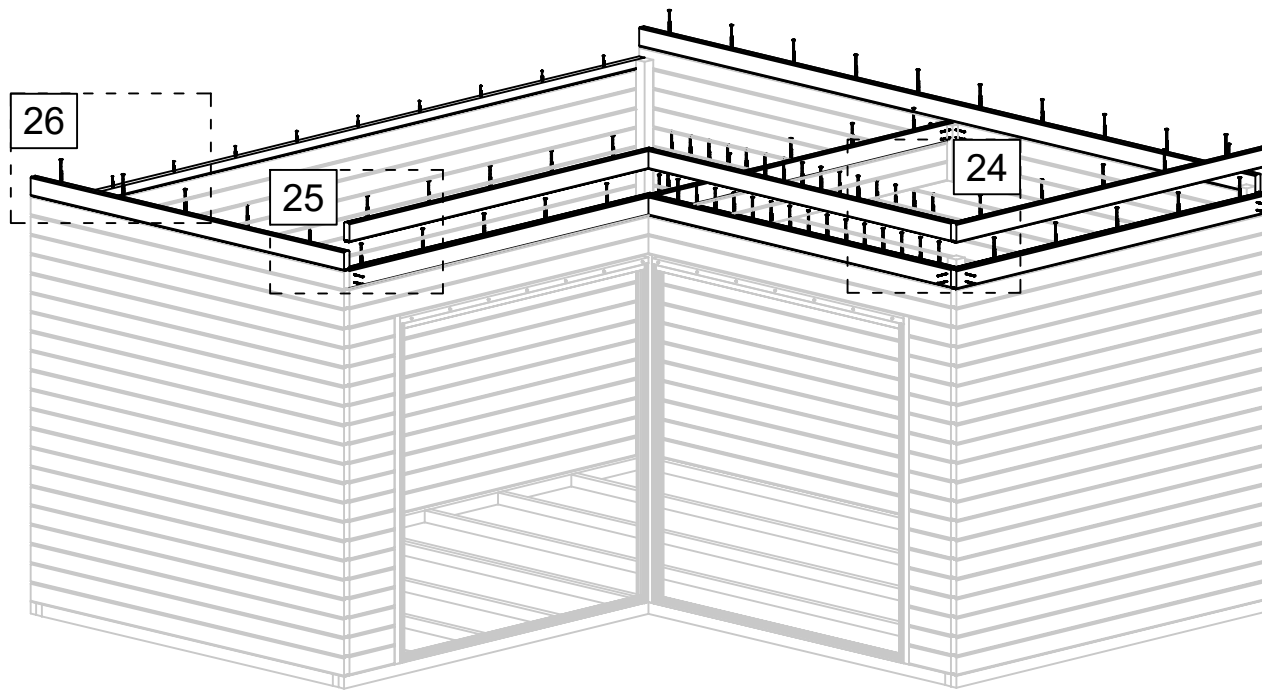

Art. Nr. 4424919

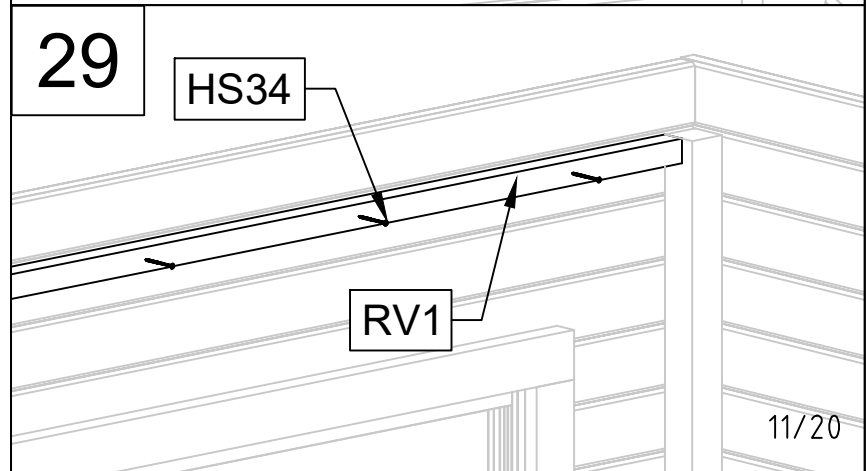
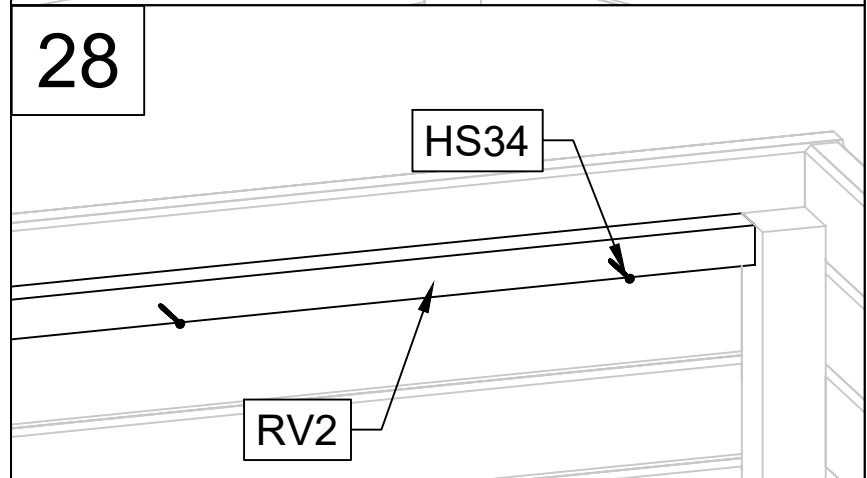
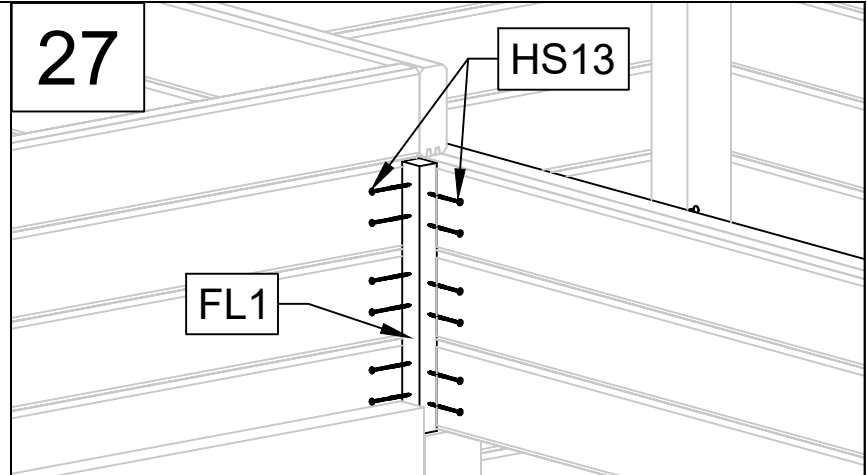
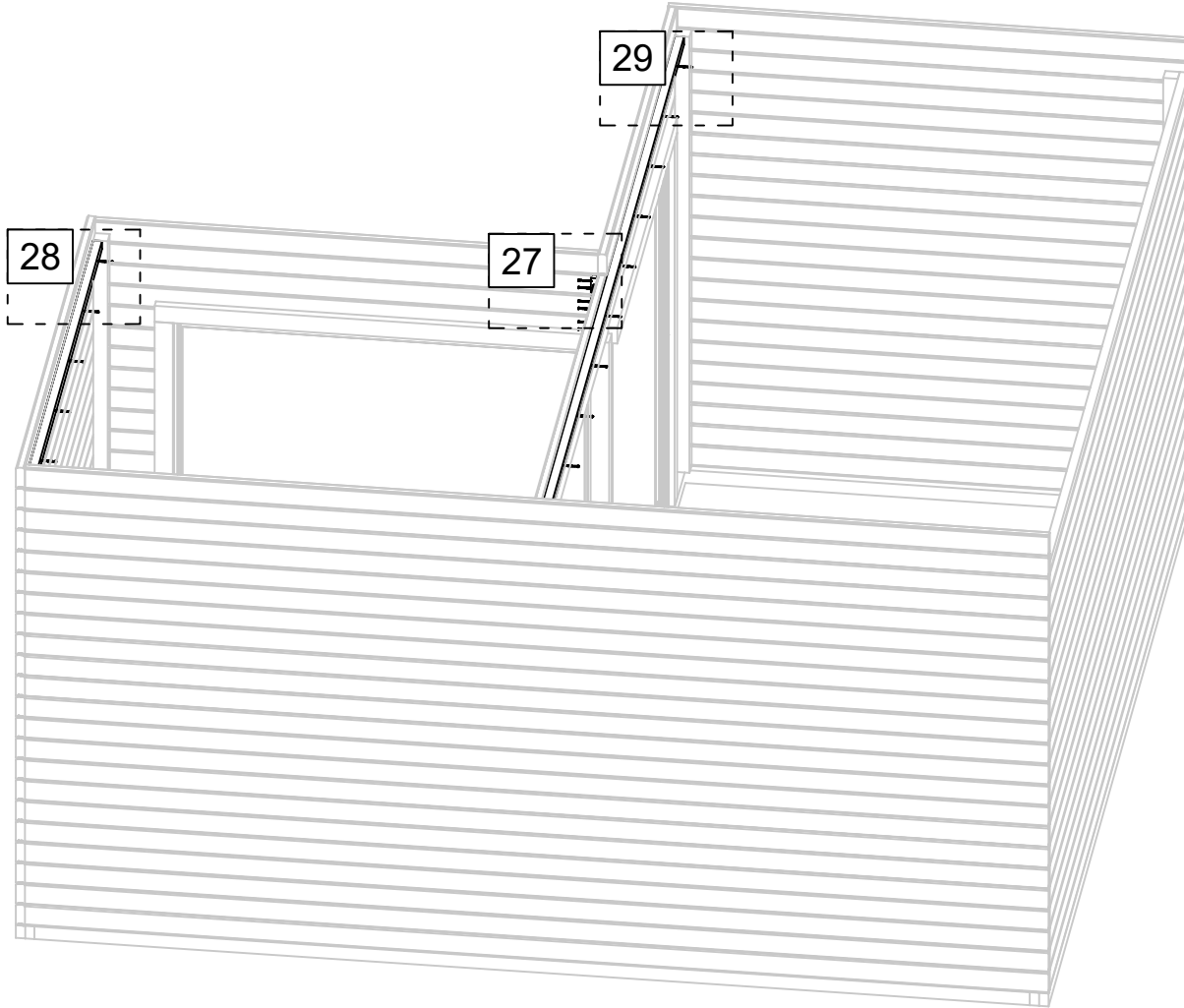

Art. Nr. 4424919

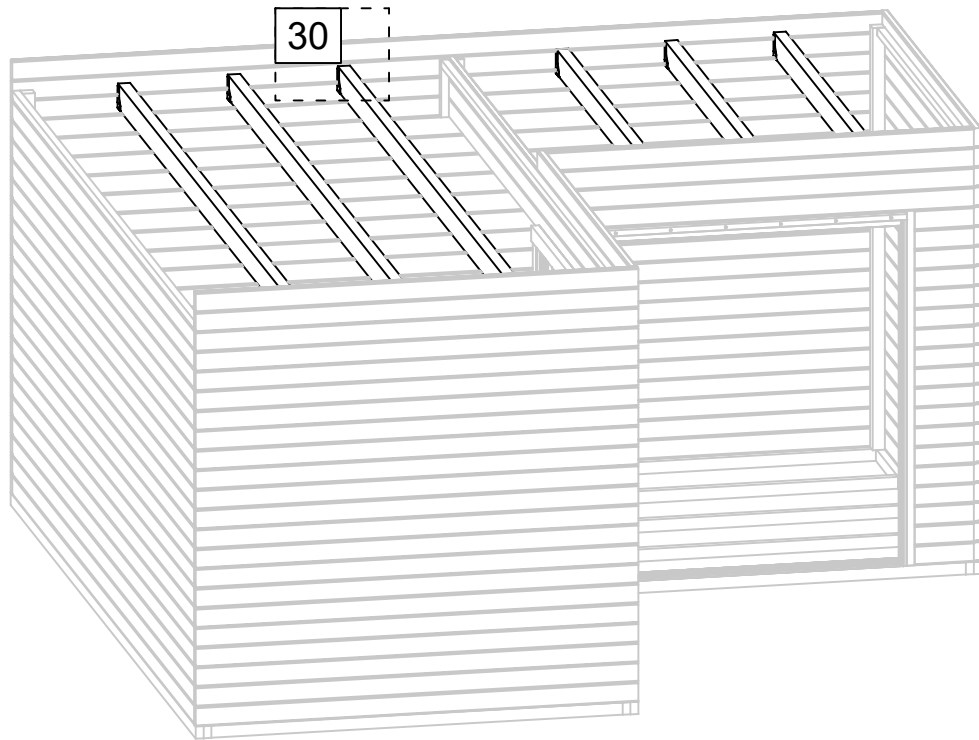

30

≈1,5cm

BM

HS12

HS12

BM

HS12

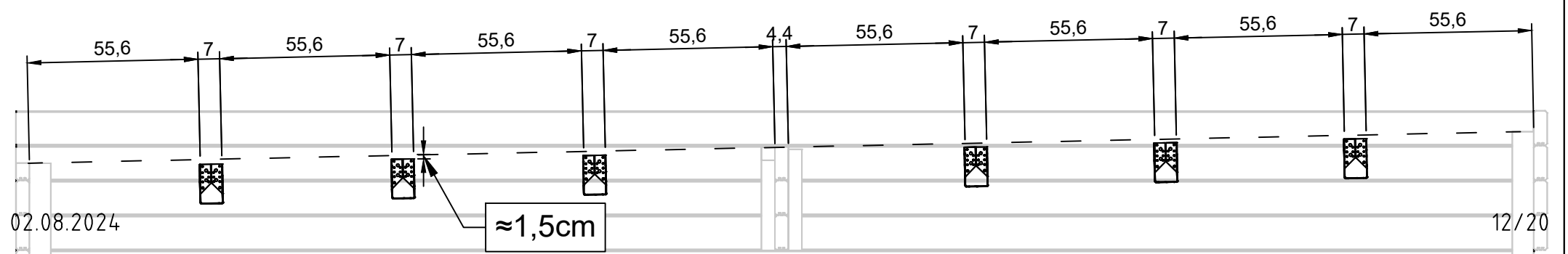

Art. Nr. 4424919

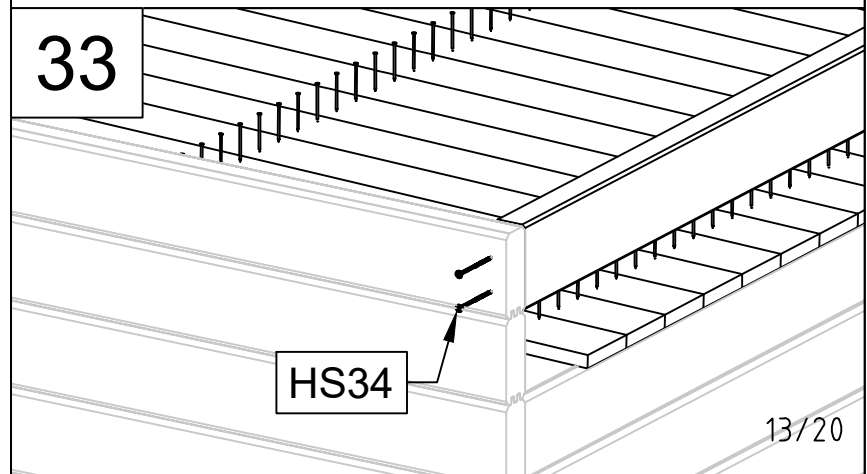
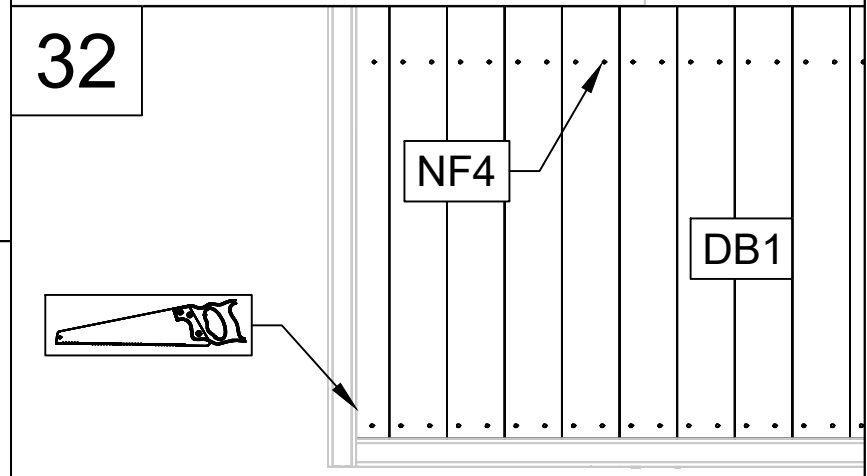
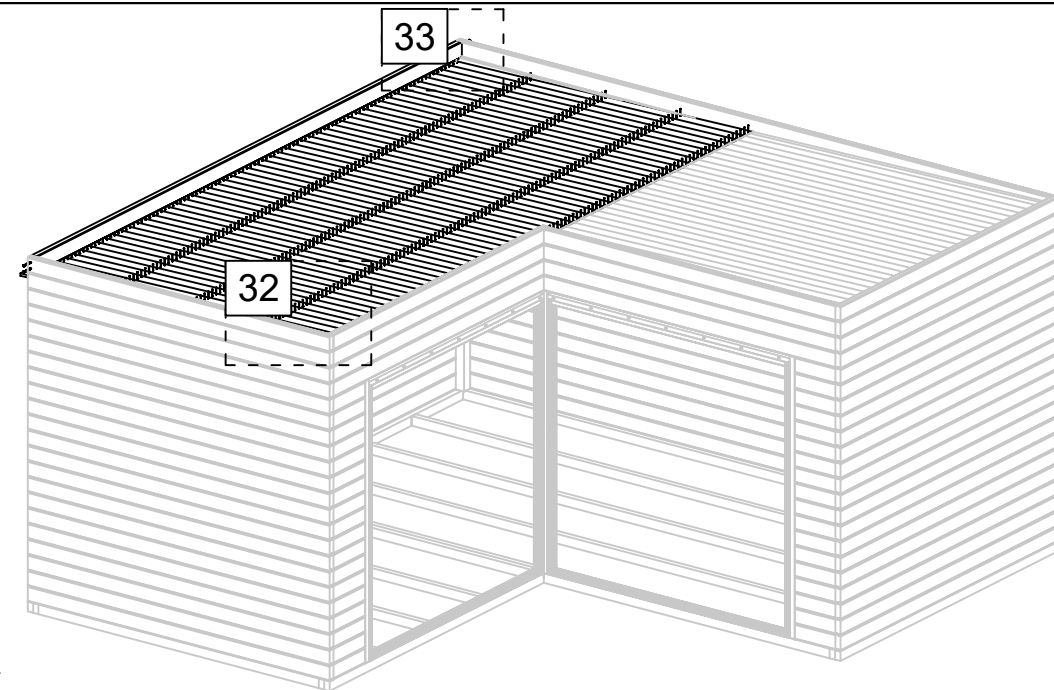
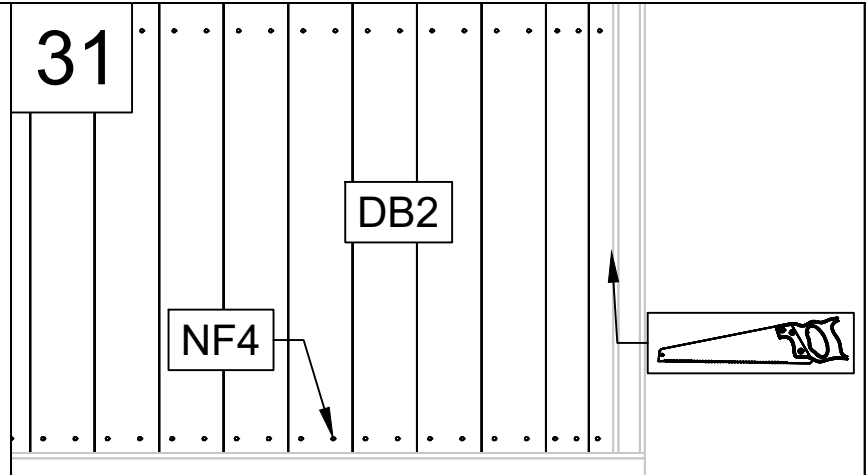
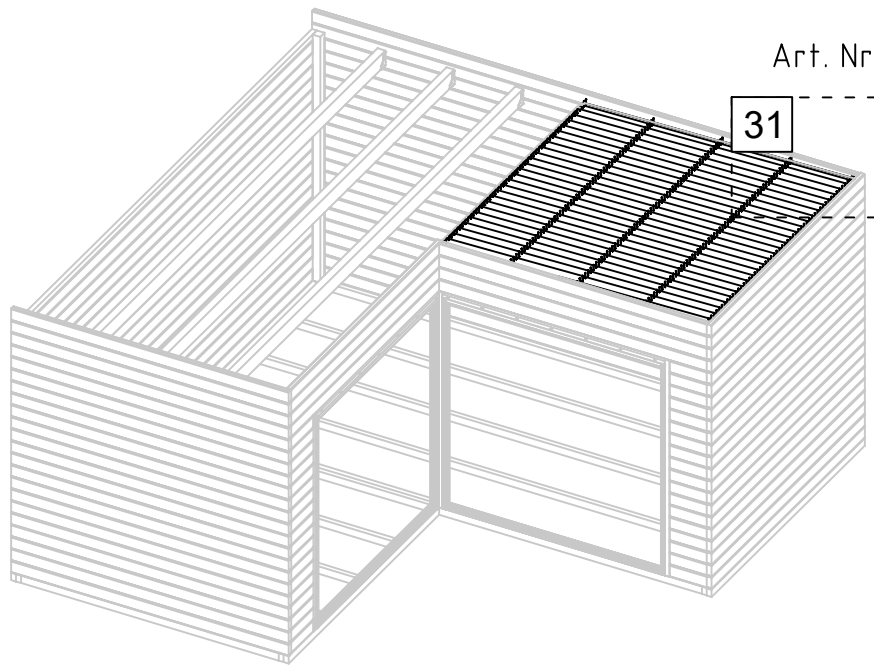

Art. Nr. 4424919

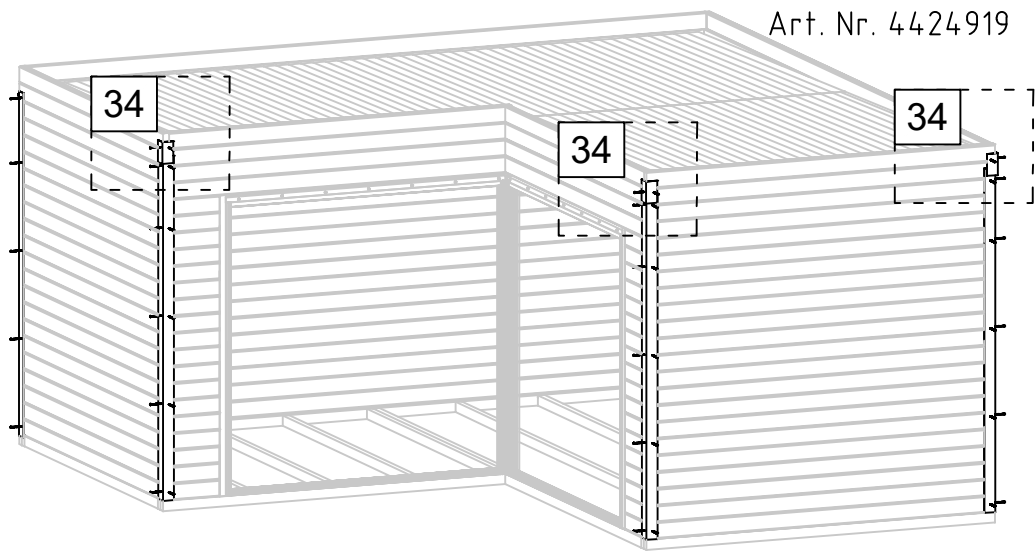

34

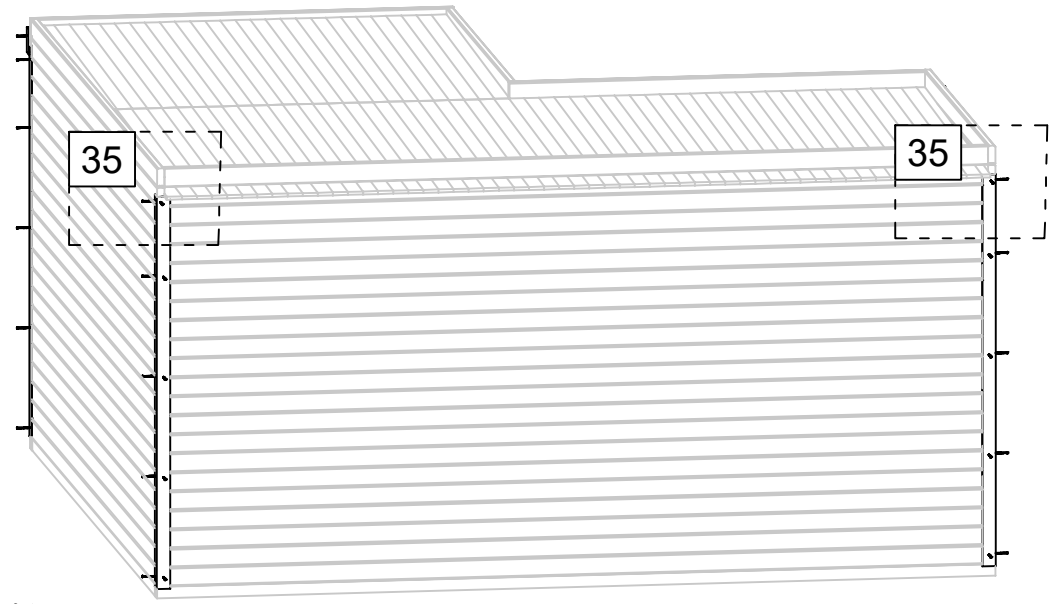
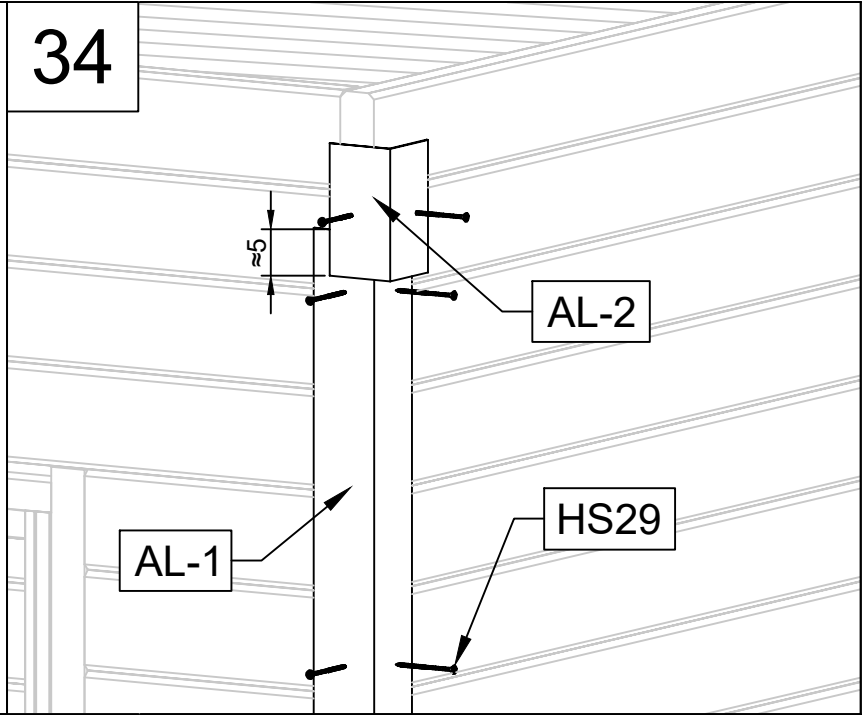

35

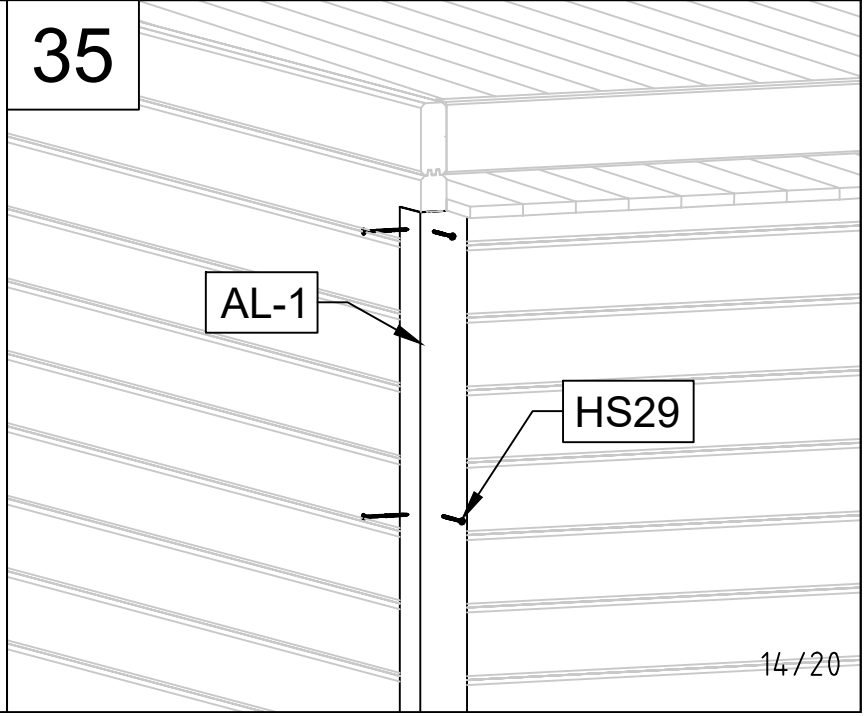

Art. Nr. 4424919

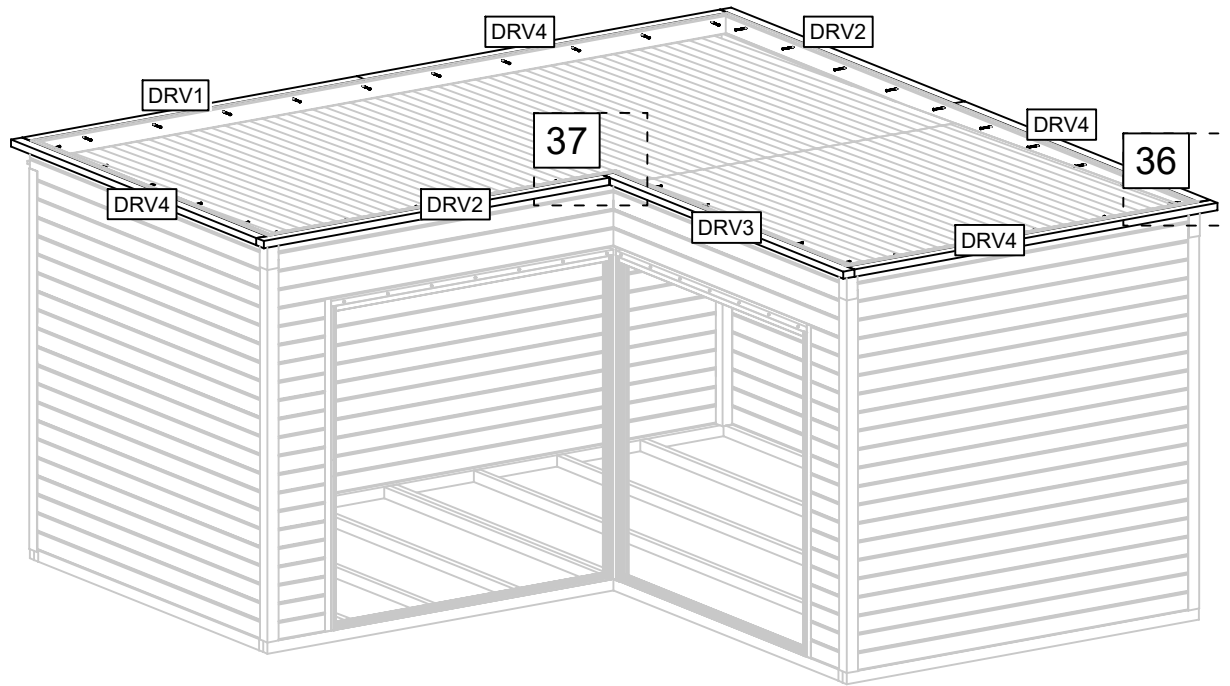

36

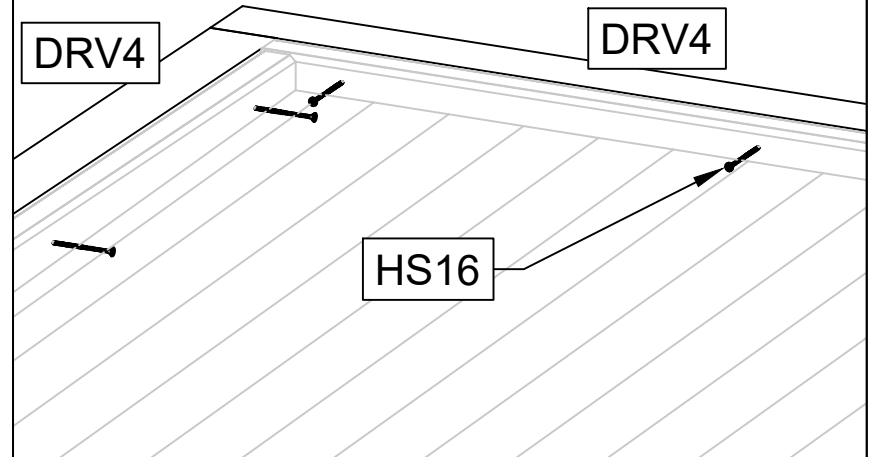

37

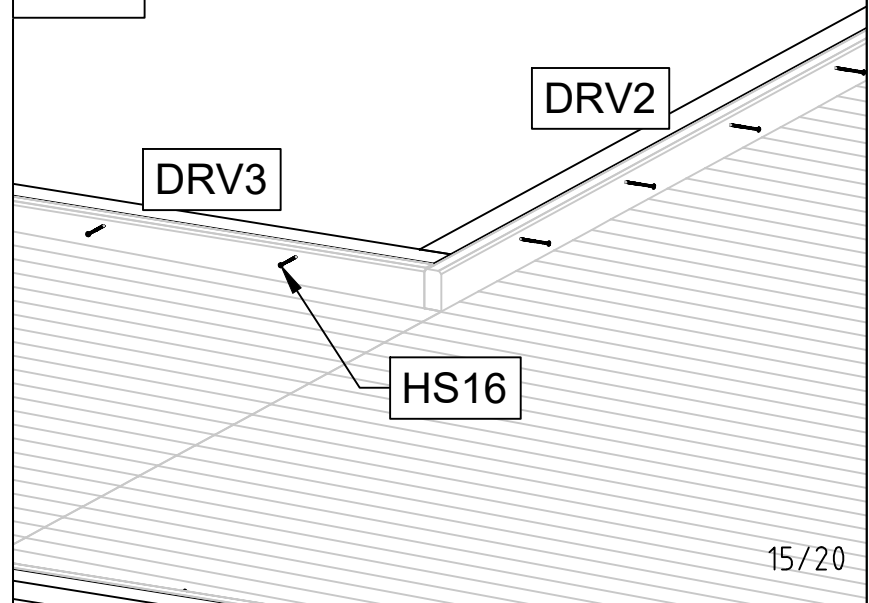

Art. Nr. 4424919

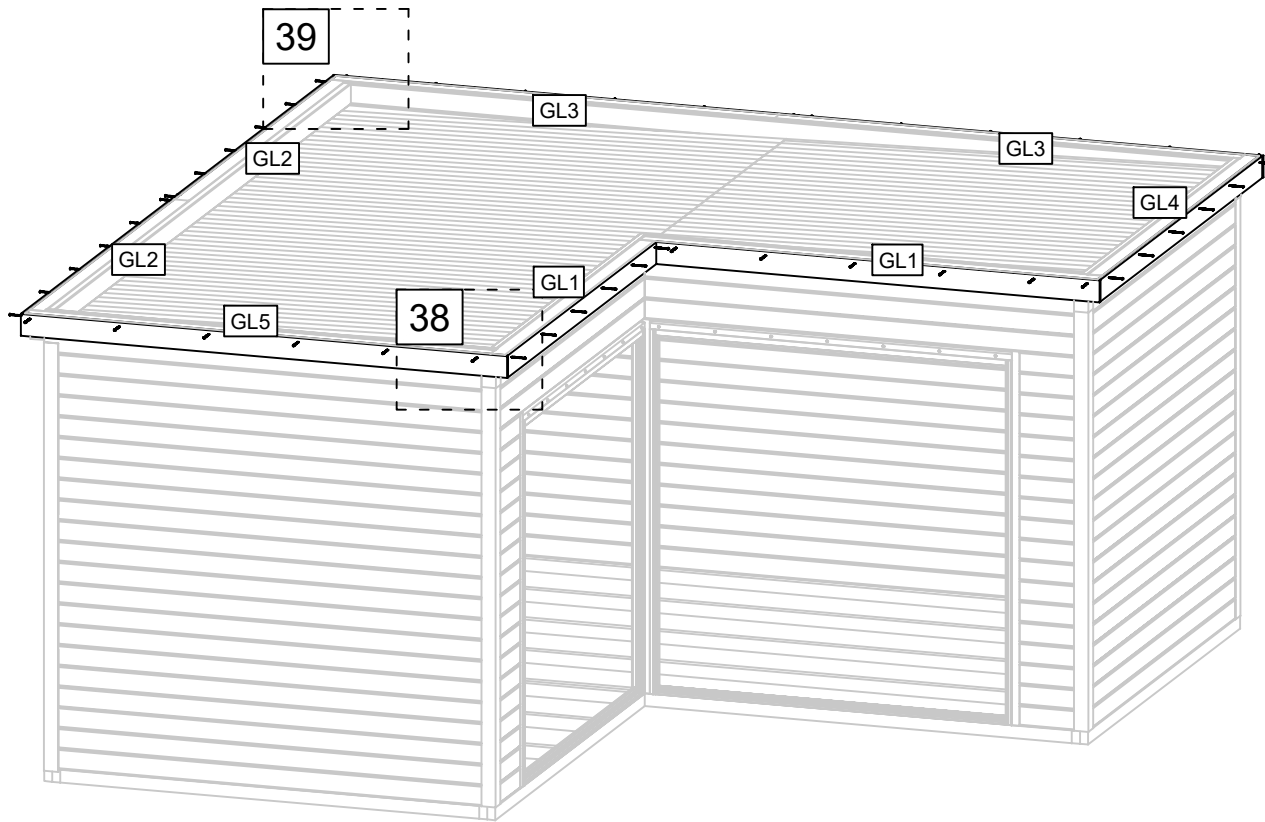

38

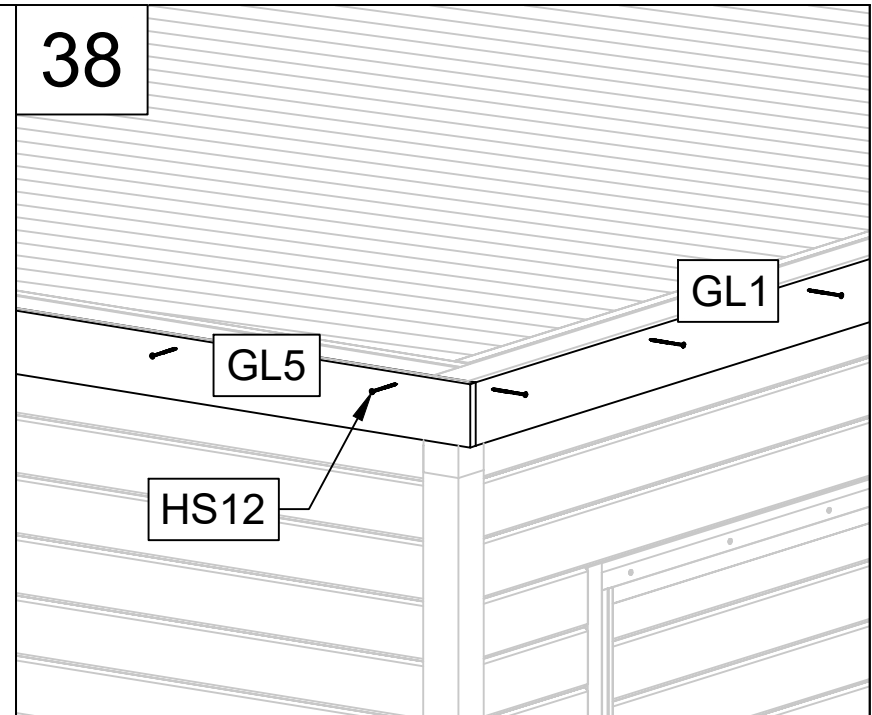

39

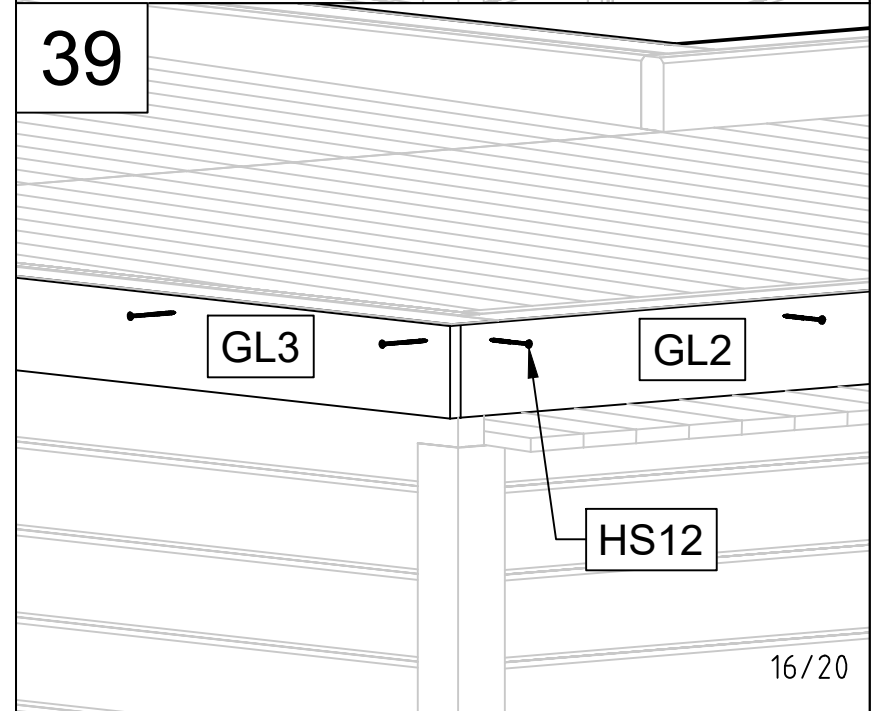

Art. Nr. 4424919

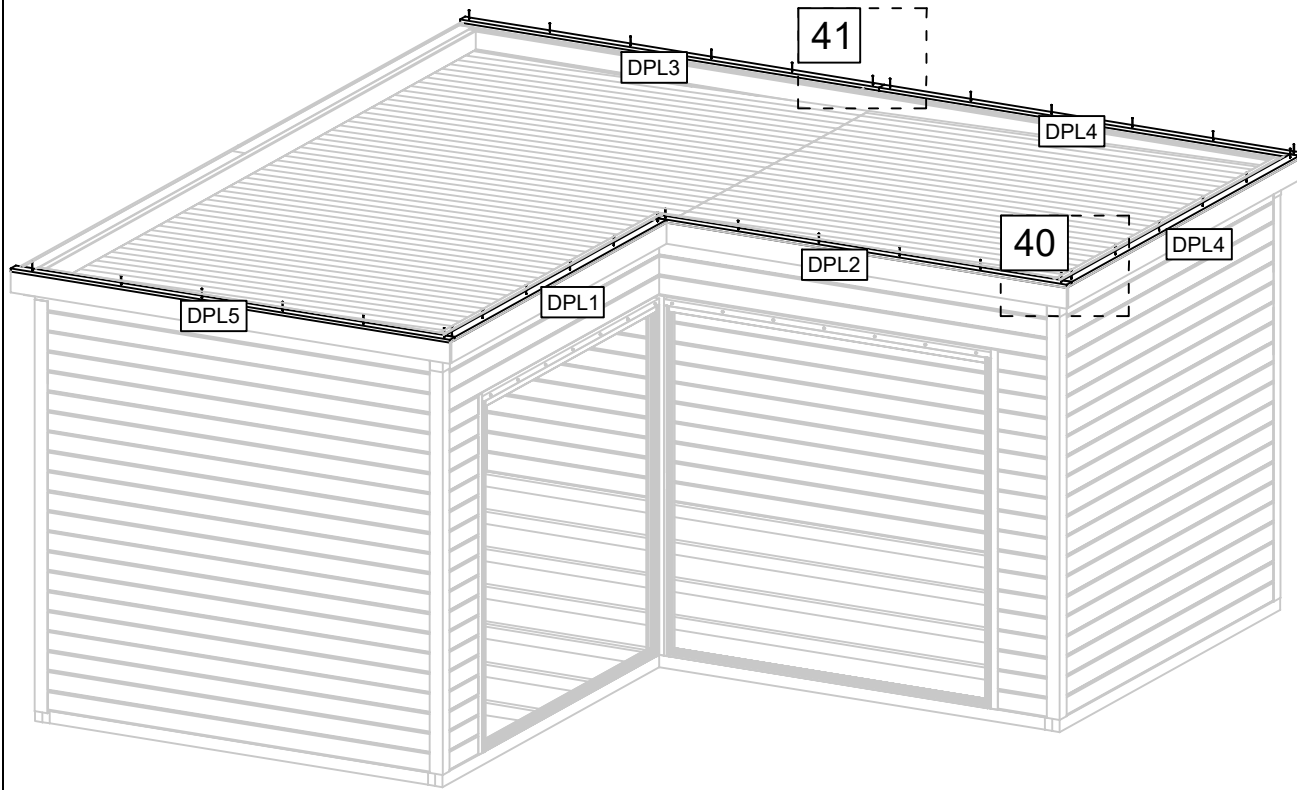

40

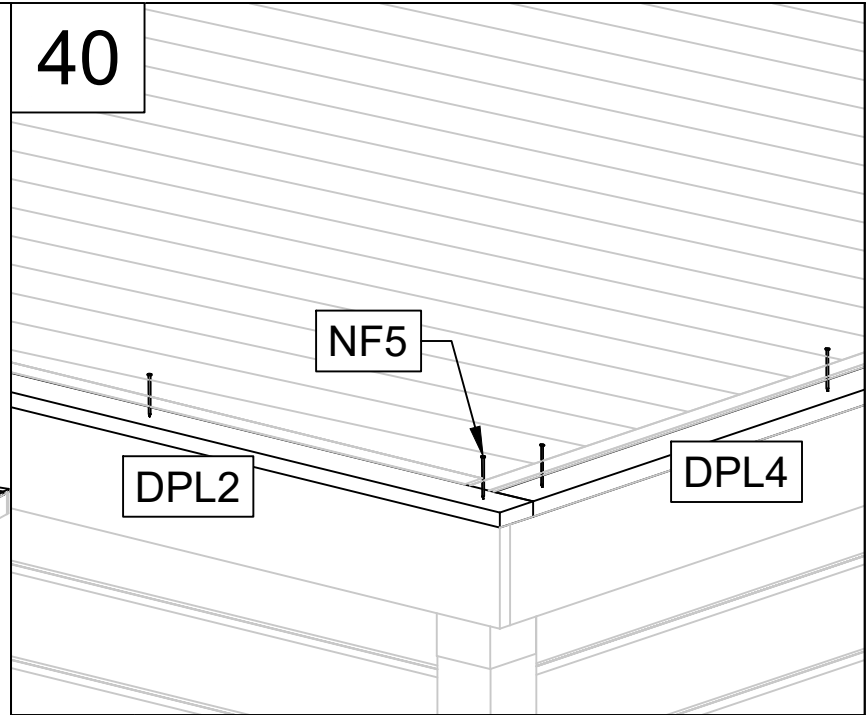

41

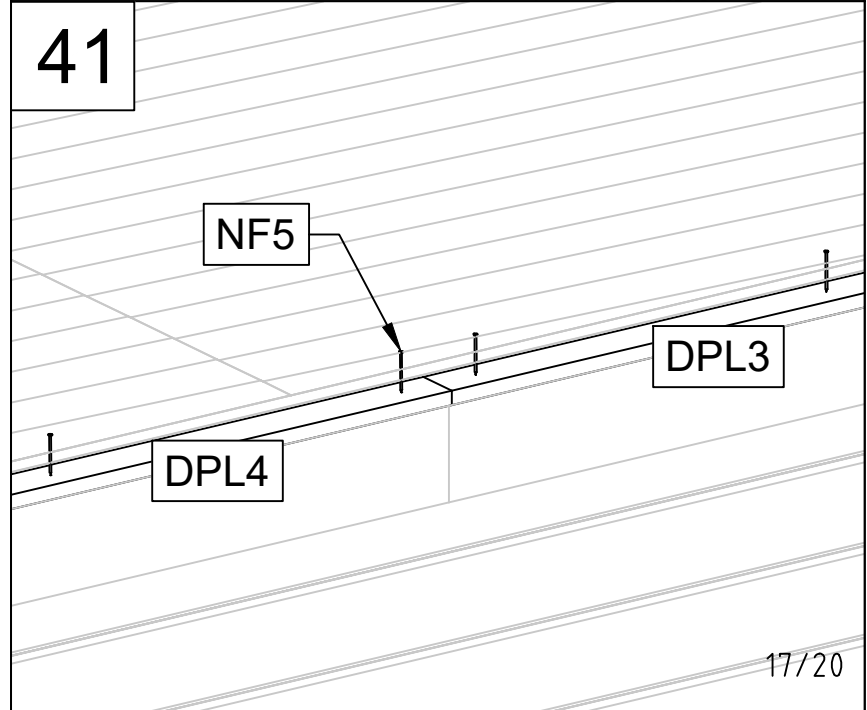

Art. Nr. 4424919

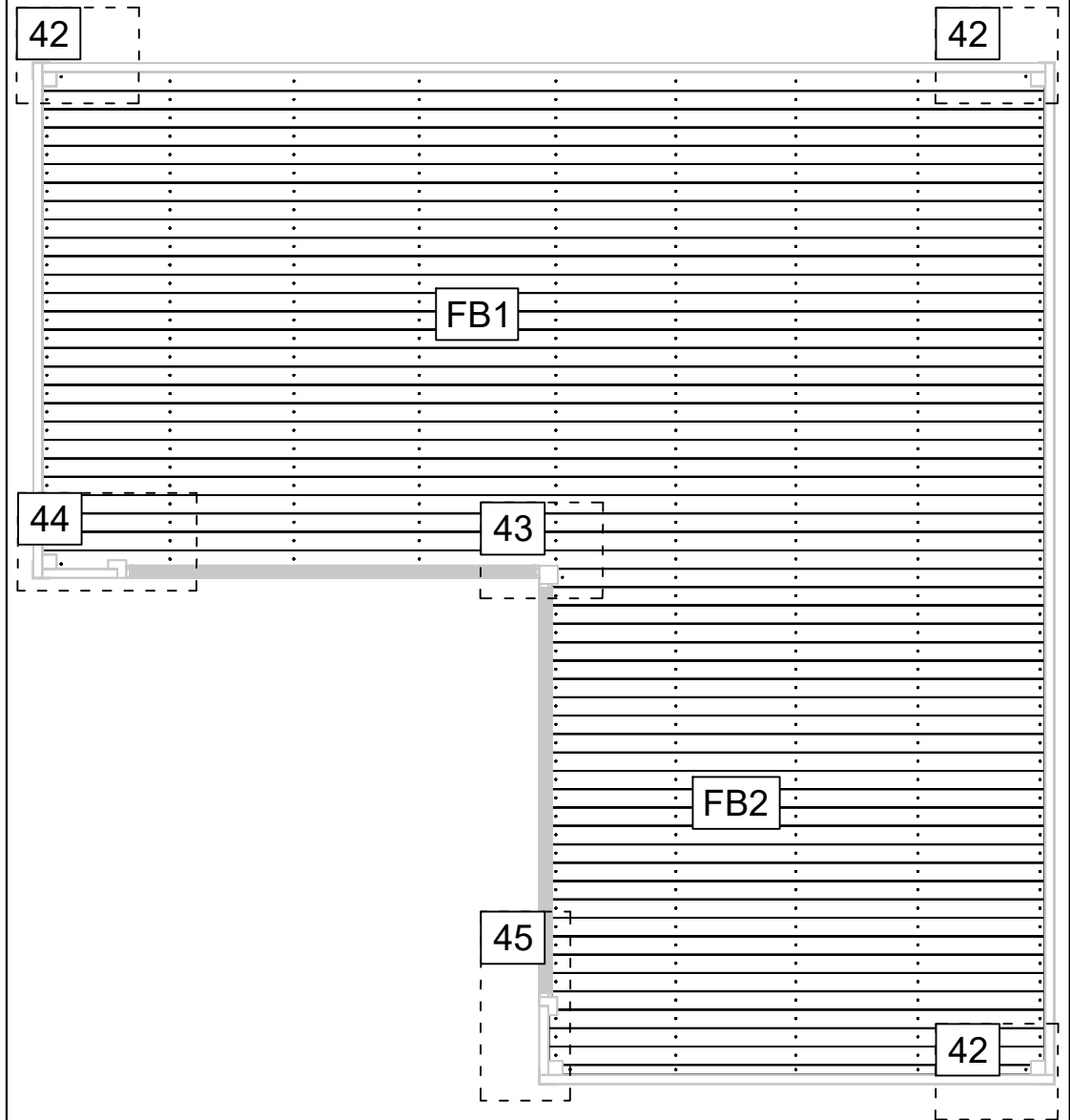
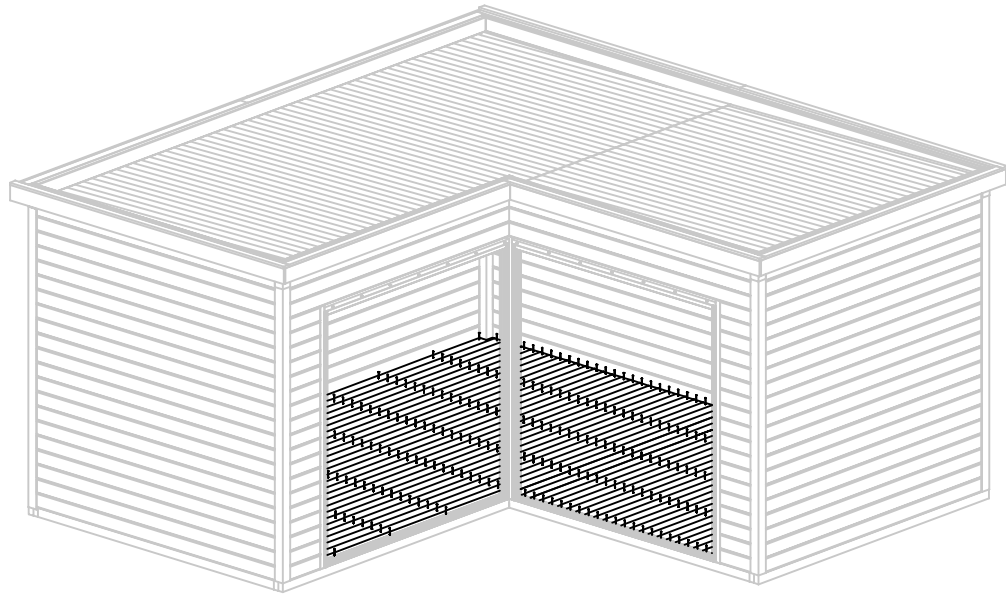

42

Art. Nr. 4424919

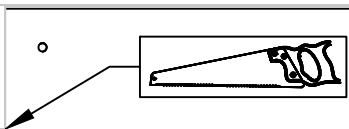

NF4

43

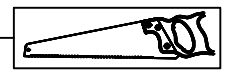

NF4

44

NF4



45



NF4

Art. Nr. 4424919

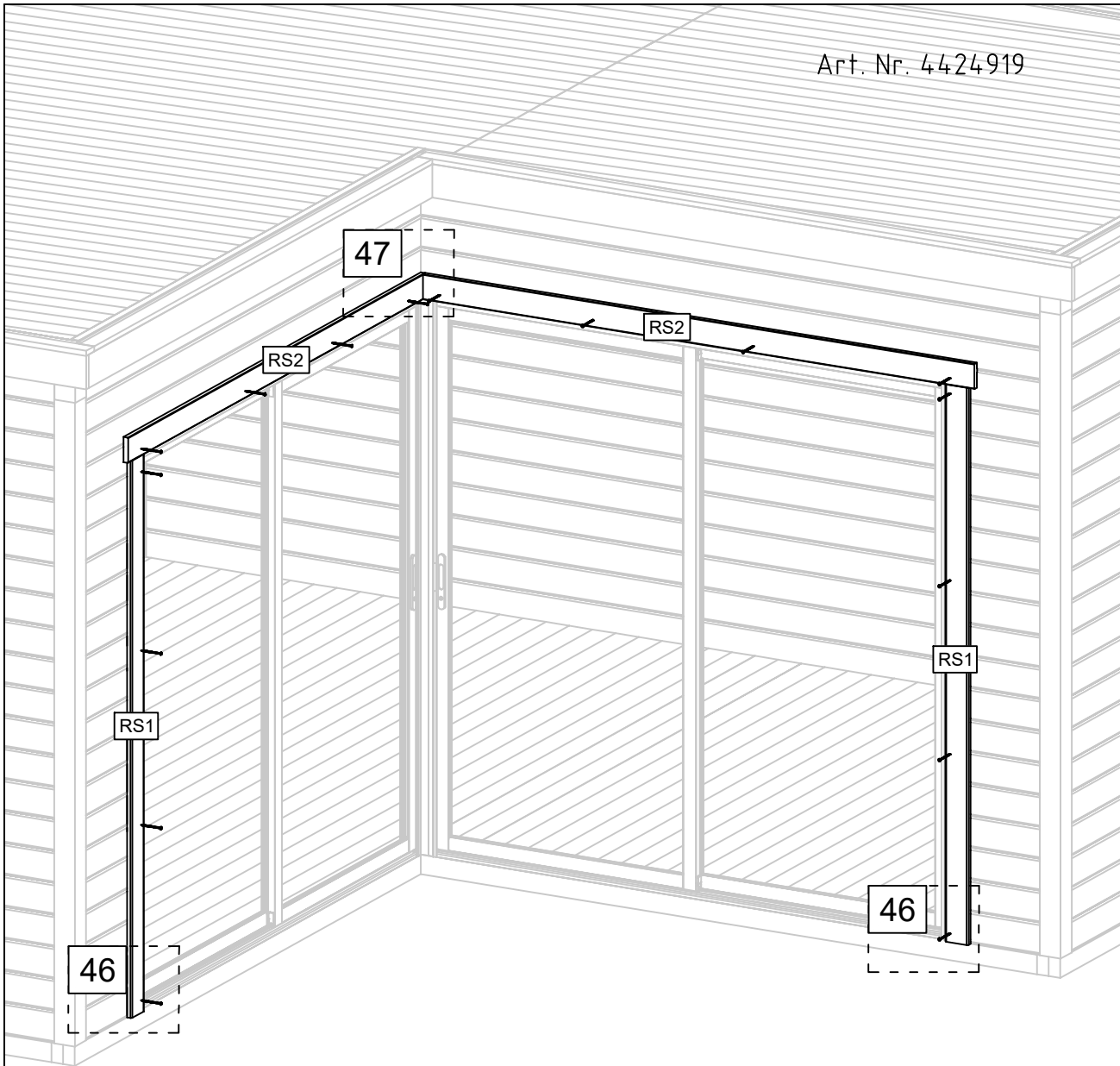

46

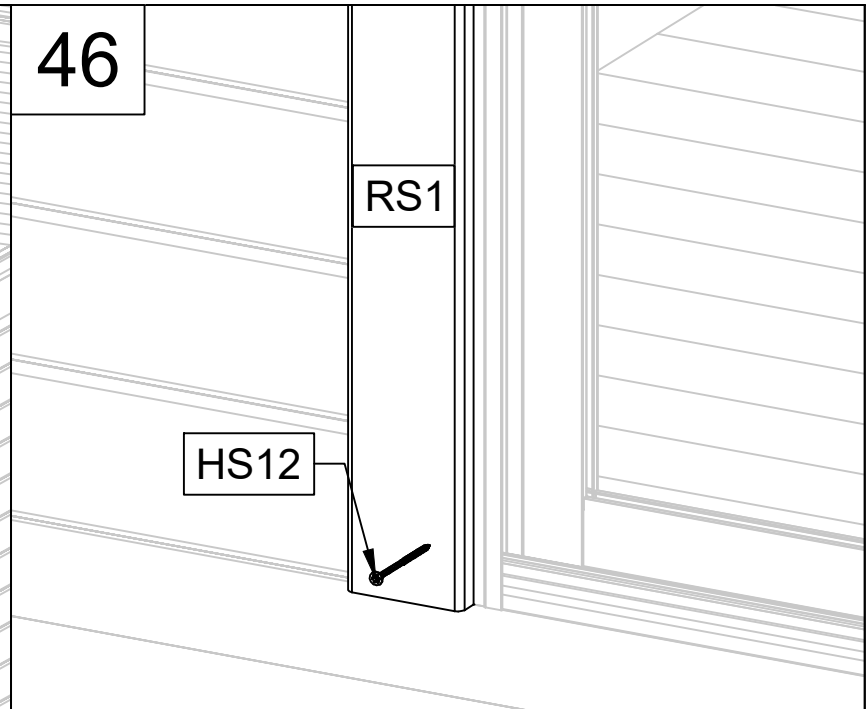

47

