

Zambezi 6
Art. Nr. 2847096
1/6

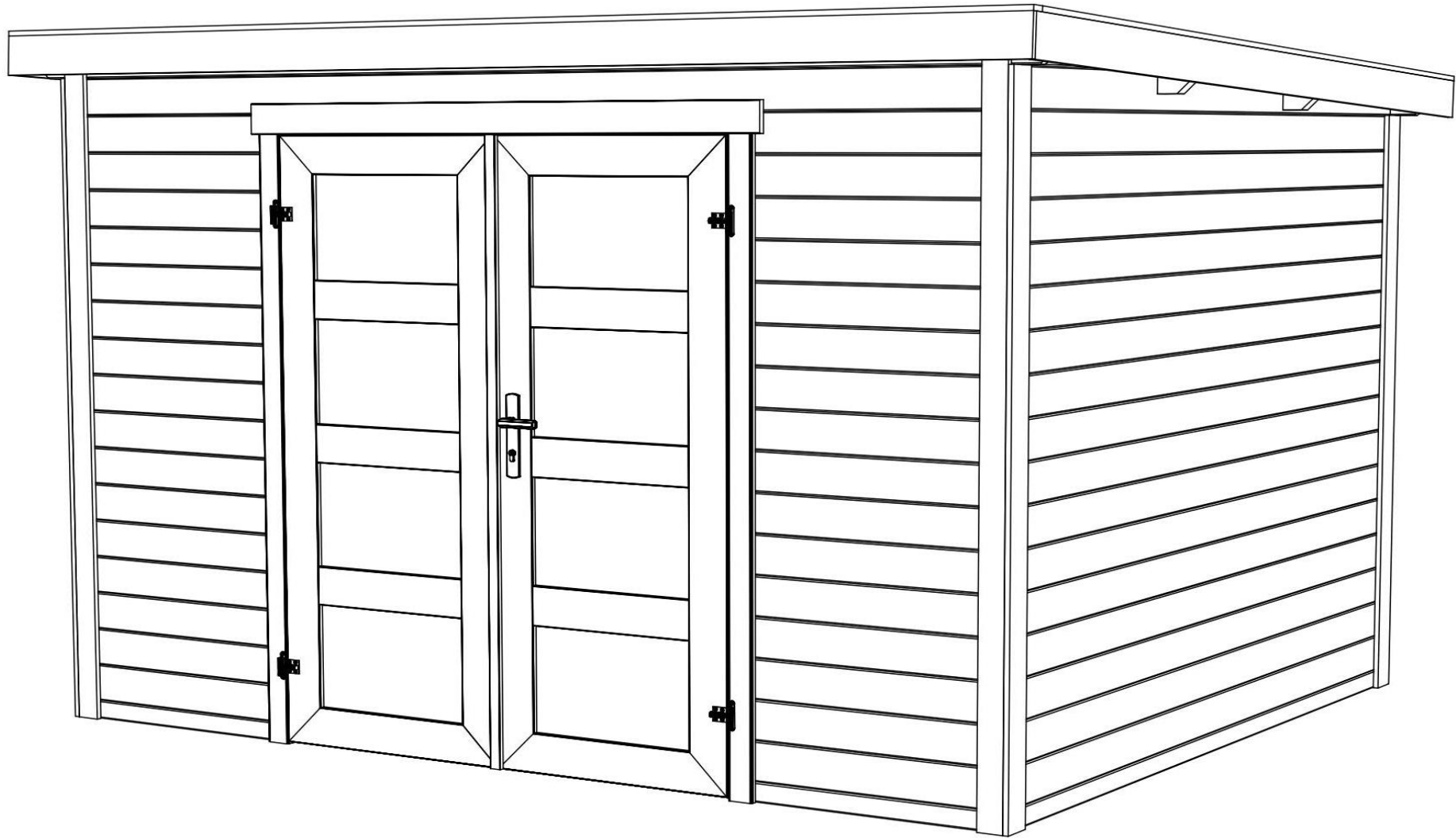

Groundplan - Grundplan - Plan de masse -
Planimetria - Plattegrond - Põhiplaan

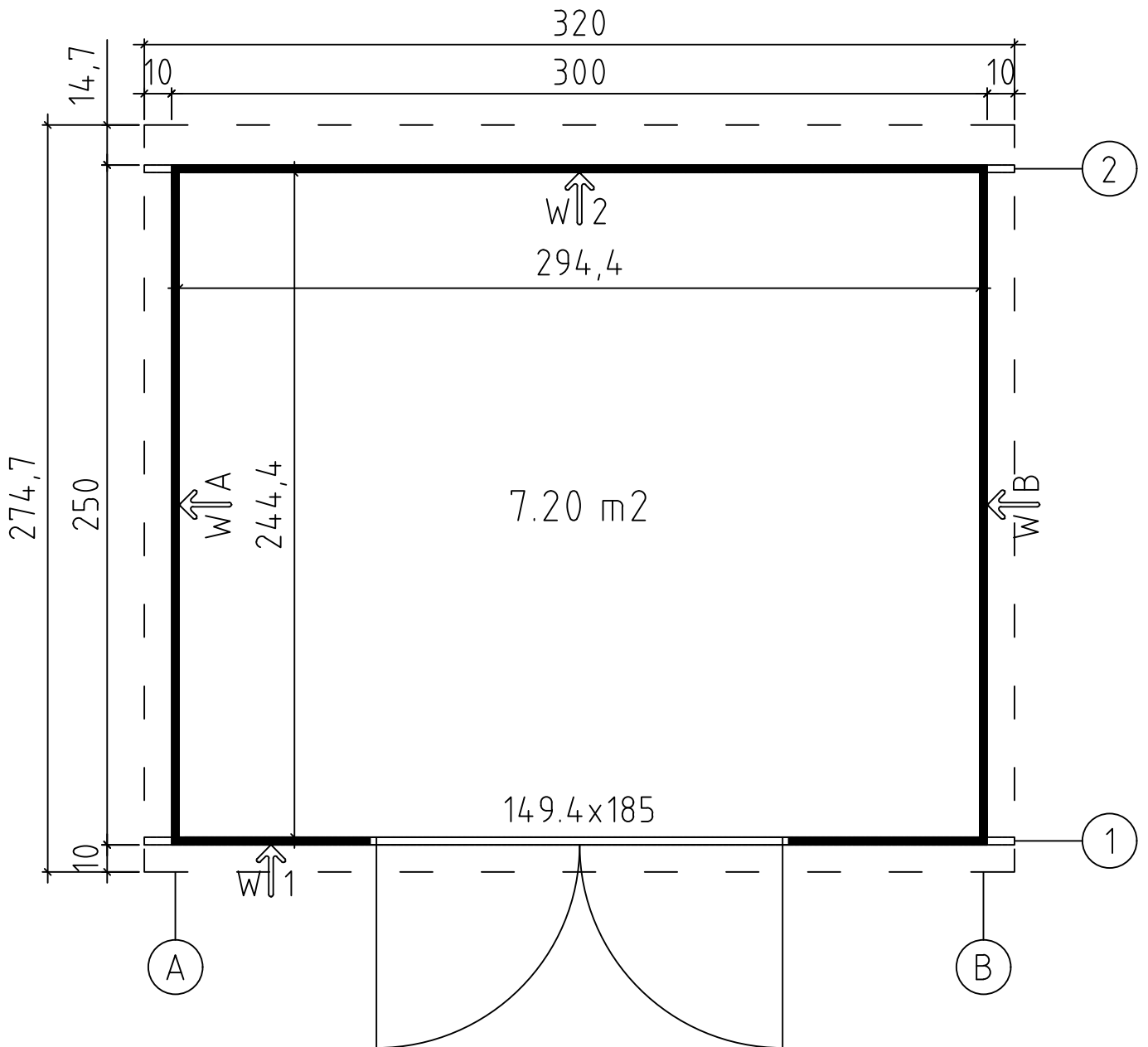



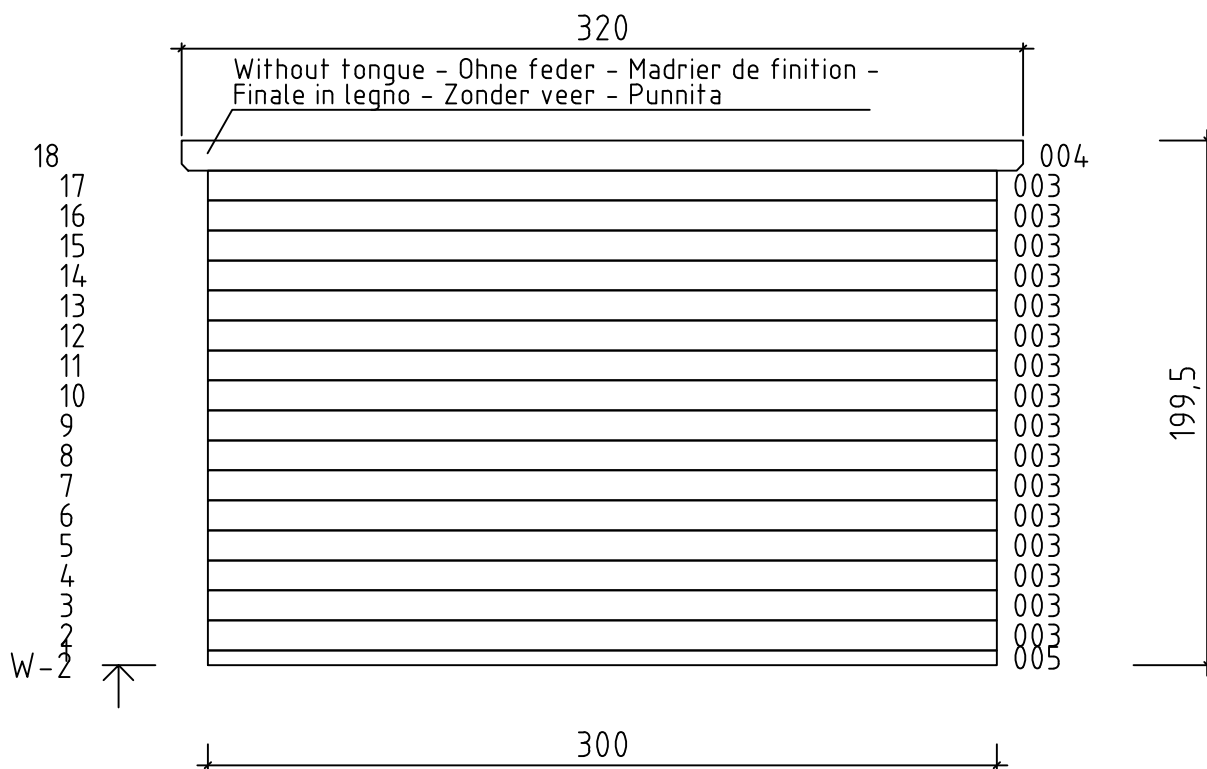
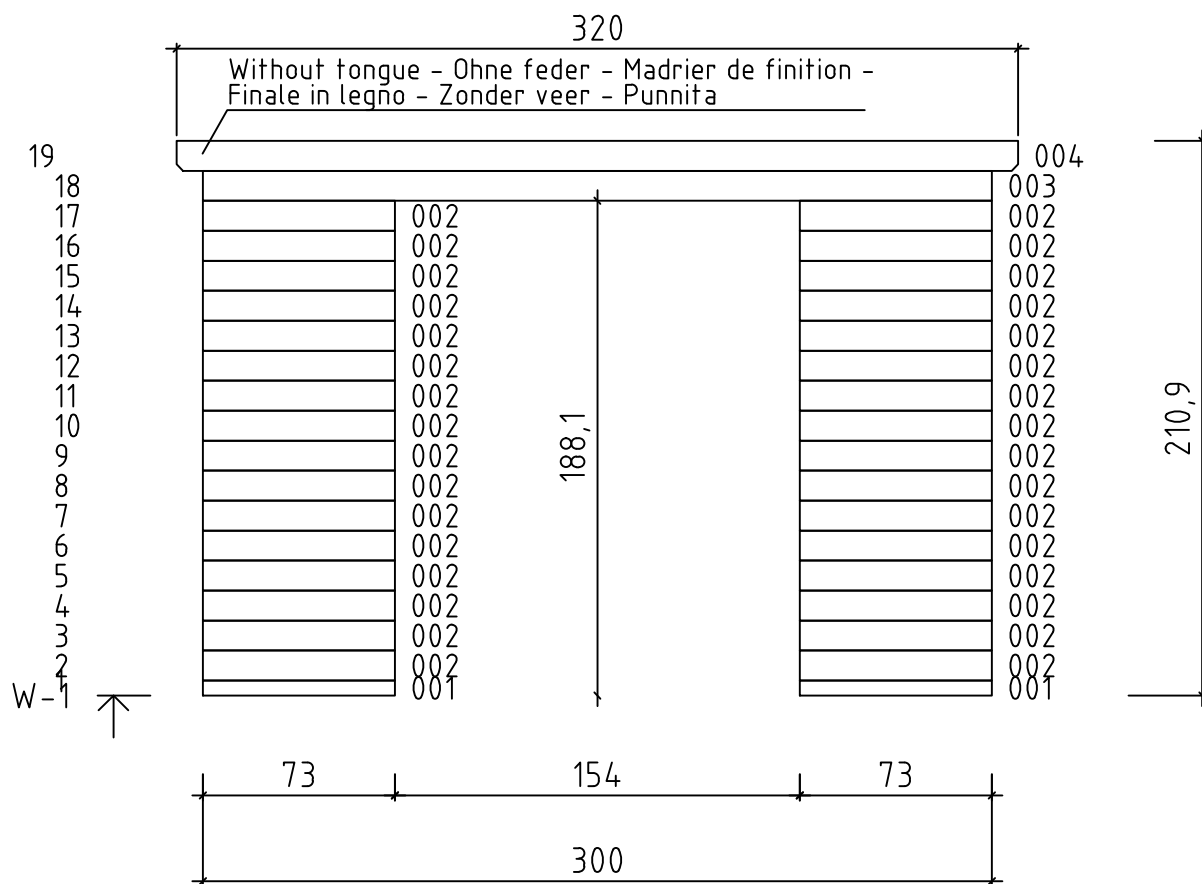



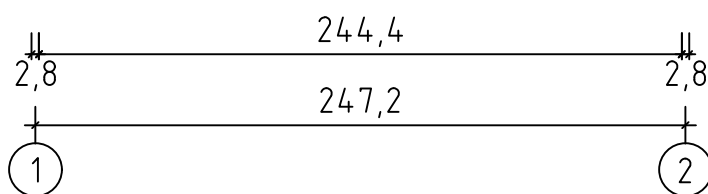
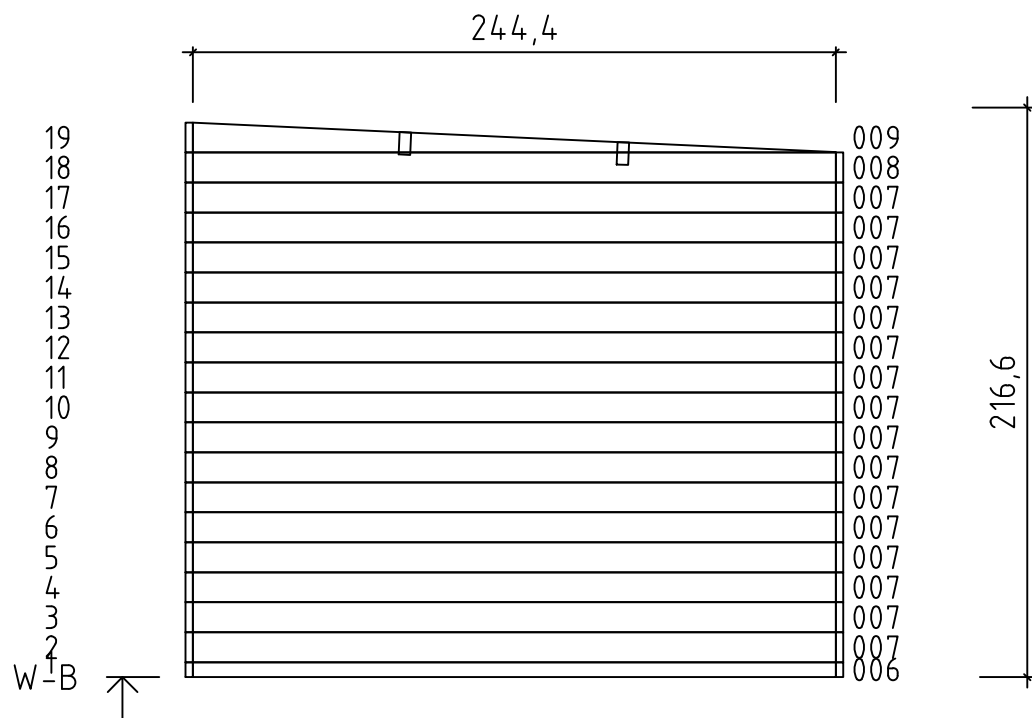
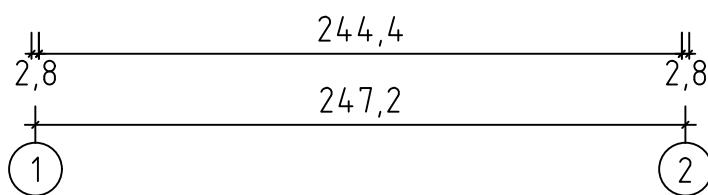
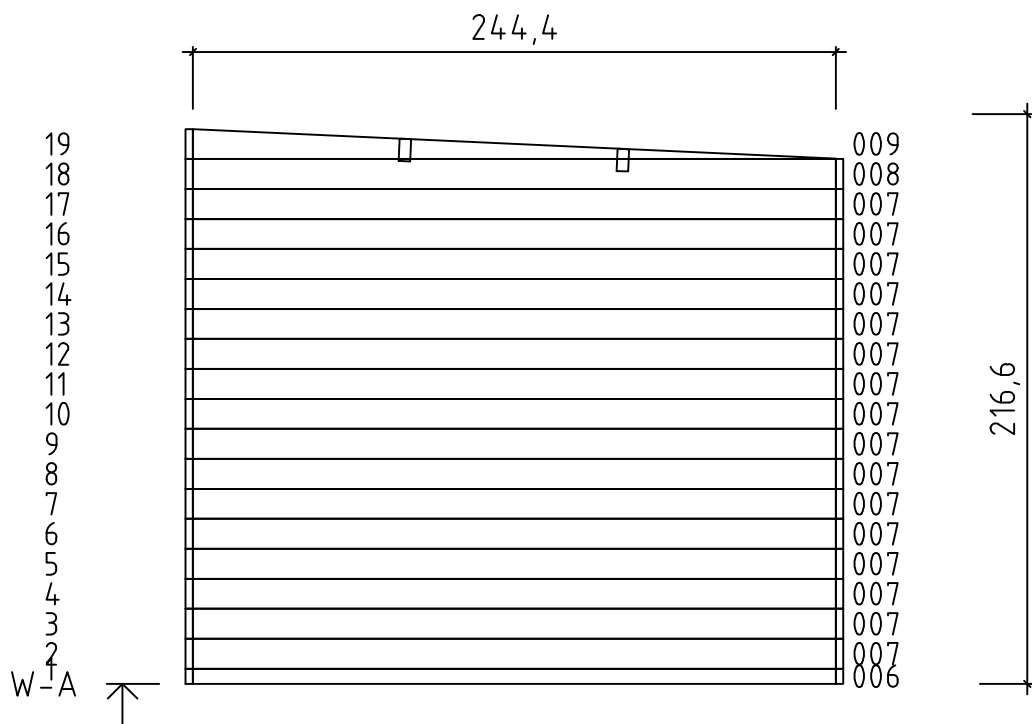

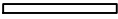



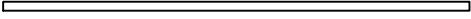
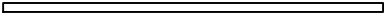

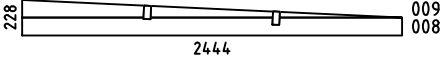
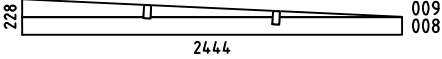
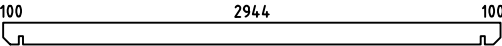
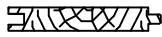







Art. Nr. 2847096

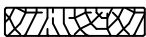
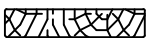

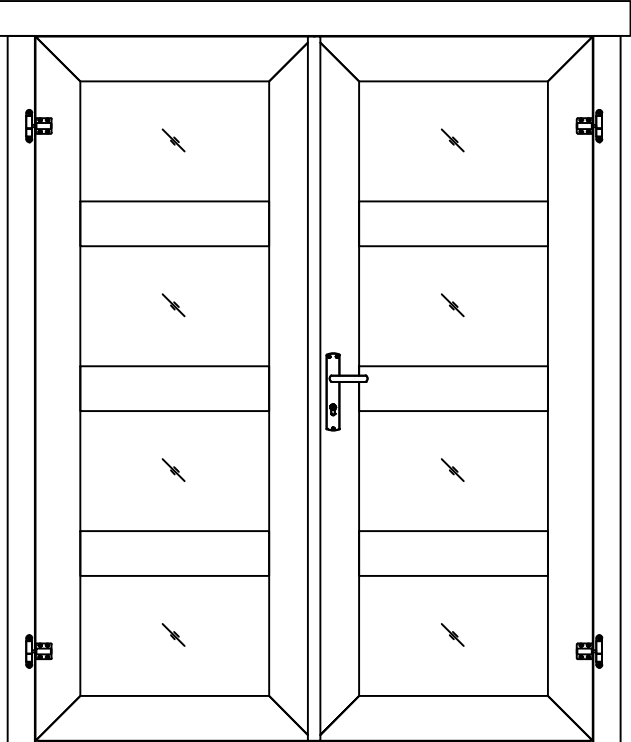
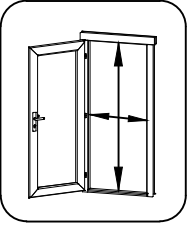
Art. Nr. 2847096



| Pos | 19.03.2024 Piece list - Stückliste - Liste des pièces - Elementi - Stuklijst - Tükítabel Art. Nr. 2847096 | 5/6 | Q | P (mm) | L (mm) |
|----------------|--|-----|----|-----------|-----------|
| 001 39986 |  | | 2 | 28x57 | 730 |
| 002 13180 |  | | 32 | 28x114 | 730 |
| 003 1021 |  | | 17 | 28x114 | 3000 |
| 004 39987 |  | | 2 | 28x114 | 3200 |
| 005 23513 |  | | 1 | 28x57 | 3000 |
| 006 23526 |  | | 2 | 28x57 | 2444 |
| 007 953 |  | | 32 | 28x114 | 2444 |
| WA-1 23599 |  | | 1 | | |
| WB-1 23599 |  | | 1 | | |
| A-PR1 33258 | Roof beam - Dachbalken - Panne de toit - Perlina del tetto - Gordingen / dakbalk - Pärlin  | | 2 | 44x146 | 3200 |
| DB 19015 | Roof boards - Dachbretter - Voliges - Perlina per tetto - Dakhout - Katuselaud  | | 36 | 90x15.5 | 2750 |
| RFF1 33603 | Roofing felt fillet - Dachpappenleiste - Baguette de fixation du feutre bitumeux - Asse per fissaggio guaina bituminosa - Afdekljst asfaltpapier - Katusepapiilist  | | 2 | 15x45 | 2770 |
| RFF2 26837 | Roofing felt fillet - Dachpappenleiste - Baguette de fixation du feutre bitumeux - Asse per fissaggio guaina bituminosa - Afdekljst asfaltpapier - Katusepapiilist  | | 1 | 15x45 | 3230 |
| DL1 39988 | Corner fillet - Deckleiste - Profils de finition angles a l'exterieur - Massello d'angolo - (hoek)lijst - Nurgaliist  | | 2 | 15x70 | 1995 |
| DL2 23517 | Corner fillet - Deckleiste - Profils de finition angles a l'exterieur - Massello d'angolo - (hoek)lijst - Nurgaliist  | | 2 | 15x70 | 2109 |
| DL3 39989 | Corner fillet - Deckleiste - Profils de finition angles a l'exterieur - Massello d'angolo - (hoek)lijst - Nurgaliist  | | 2 | 15x90 | 1881 |
| DL4 23519 | Corner fillet - Deckleiste - Profils de finition angles a l'exterieur - Massello d'angolo - (hoek)lijst - Nurgaliist  | | 2 | 15x90 | 1995 |
| P1-1 45439 | Corner stud - Eckpfosten - Poteaux d'angle pour fixation des madriers - Perno angolare - Hoek staander (kolom) - Nurgapost  | | 2 | 55x55 | 1995 |
| P1-2 46411 | Corner stud - Eckpfosten - Poteaux d'angle pour fixation des madriers - Perno angolare - Hoek staander (kolom) - Nurgapost  | | 2 | 55x55 | 2100 |
| TB 22392 | Fascia board - Traufbrett - Bandeau de toit - Finitura lati tetto - Gevellijst - Räästalaud  | | 1 | 15x45 | 3200 |
| TL 23522 | Fixing fillet - Fixirungleiste - Profil de fixation - Massello di fissaggio - Bevestiging lijstwerk - Tenderliist  | | 2 | 18x28 | 1850 |
| GL1 39990 | Gable moulding - Giebelleiste - Planche de rive - Finitura per frontale e retro del tetto - Gevellijst - Viilulaud  | | 2 | 15x120 | 2800 |
| GL2 26840 | Gable moulding - Giebelleiste - Planche de rive - Finitura per frontale e retro del tetto - Gevellijst - Viilulaud  | | 1 | 15x120 | 3230 |

| Pos | 11.02.2020 Piece list - Stückliste - Liste des pièces - Elementi - Stuklijst - Tükítabel 1494x1850 TUK.4.020.MXVP.MMX28 MXGA+28 | 1/2 | Q | P (mm) | L (mm) |
|---|---|---|---|-----------|-----------|
| <p>Glass size - Glasgröße - Taille de la vitre - Misura del vetro - Glas afmeting - Klaasi mõõt: 502x325 mm</p>   <p>1418x1792 mm</p> | | | | | |
| 1 | Upper door jamb - Türrahmen oben - Cadre de porte supérieur - Telaio superiore della porta - Bovendorpel - Ukse ülemine leng |  | 1 | 66x100 | 1438 |
| 2 | Left door jamb - Türrahmen links - Cadre de porte gauche - Telaio montante sinistro della porta - Linkerstijl deurframe - Ukse vasak leng |  | 1 | 66x80 | 1850 |
| 3 | Right door jamb - Türrahmen rechts - Cadre de porte droit - Telaio montante destro della porta - Rechterstijl deurframe - Ukse parem leng |  | 1 | 66x80 | 1850 |
| 4 | Doorstep - Swelle - Barre de seuil - Soglia della porta - Deurdorpel - Lävepak |  | 1 | 20x21 | 1418 |
| 5 | Connection strip - Deckleiste - Baguette de battement - Profilo verticale della porta - Stulplijst - kokkuvaltšiliist |  | 1 | 13x32 | 1812 |

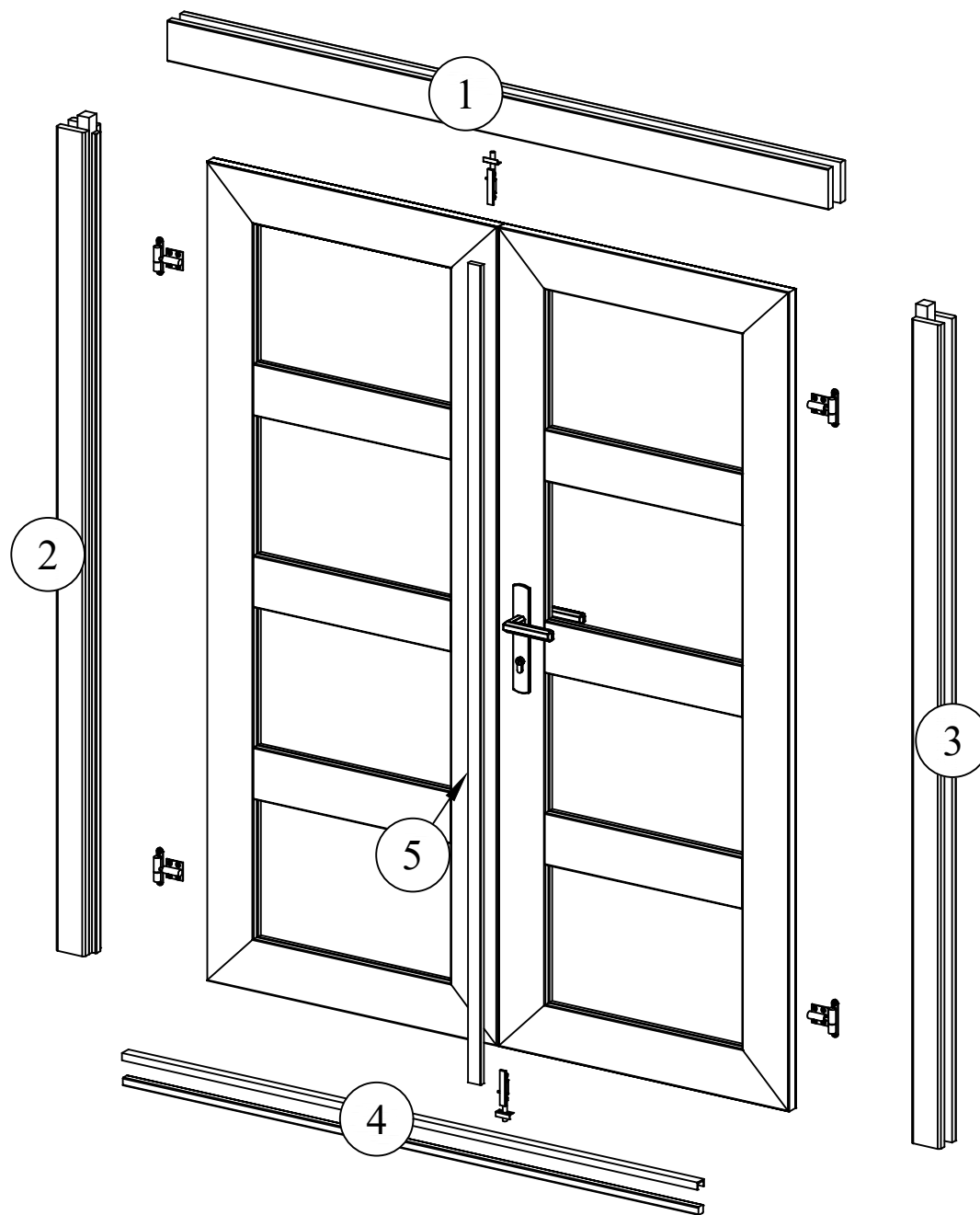

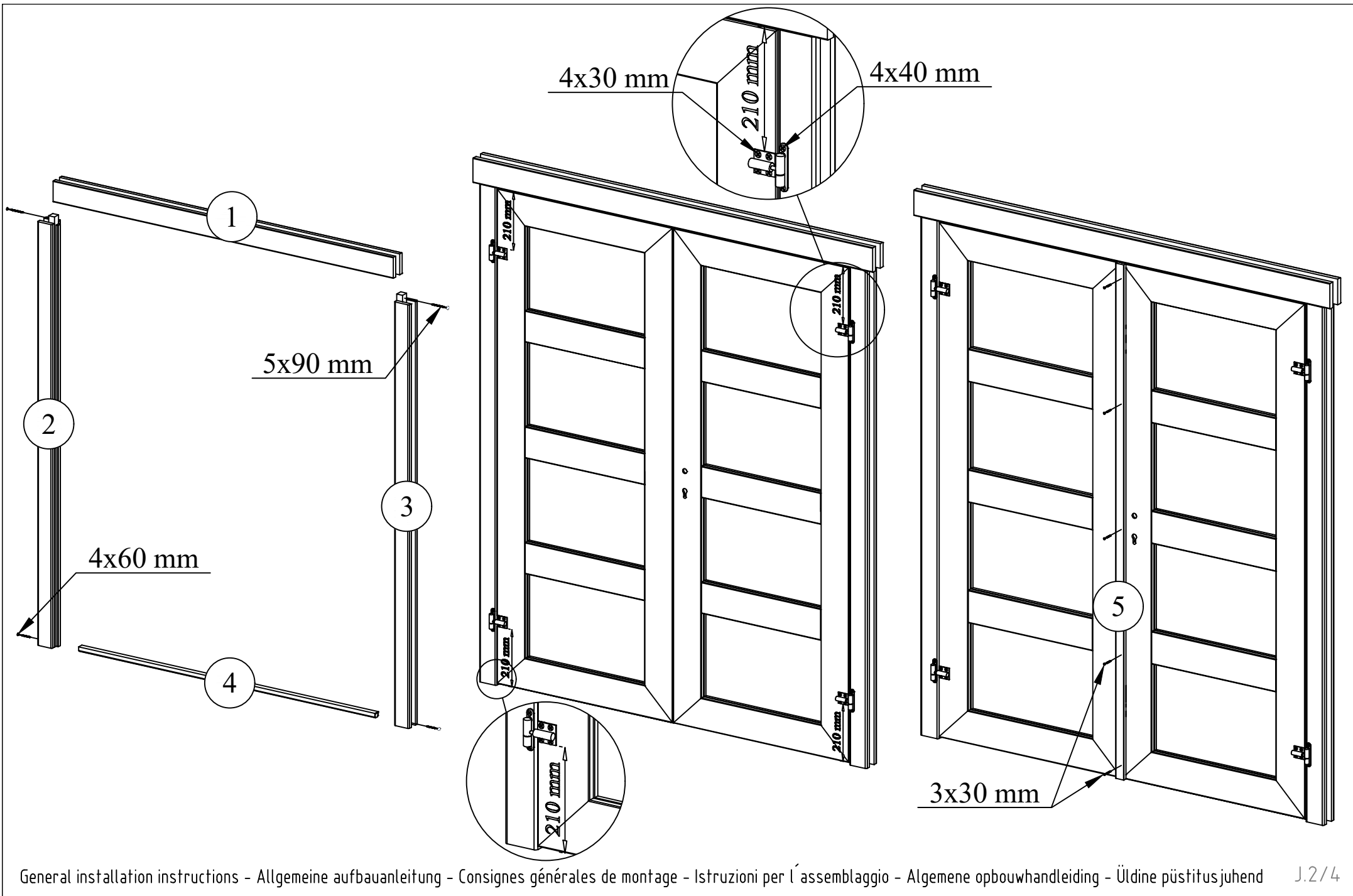

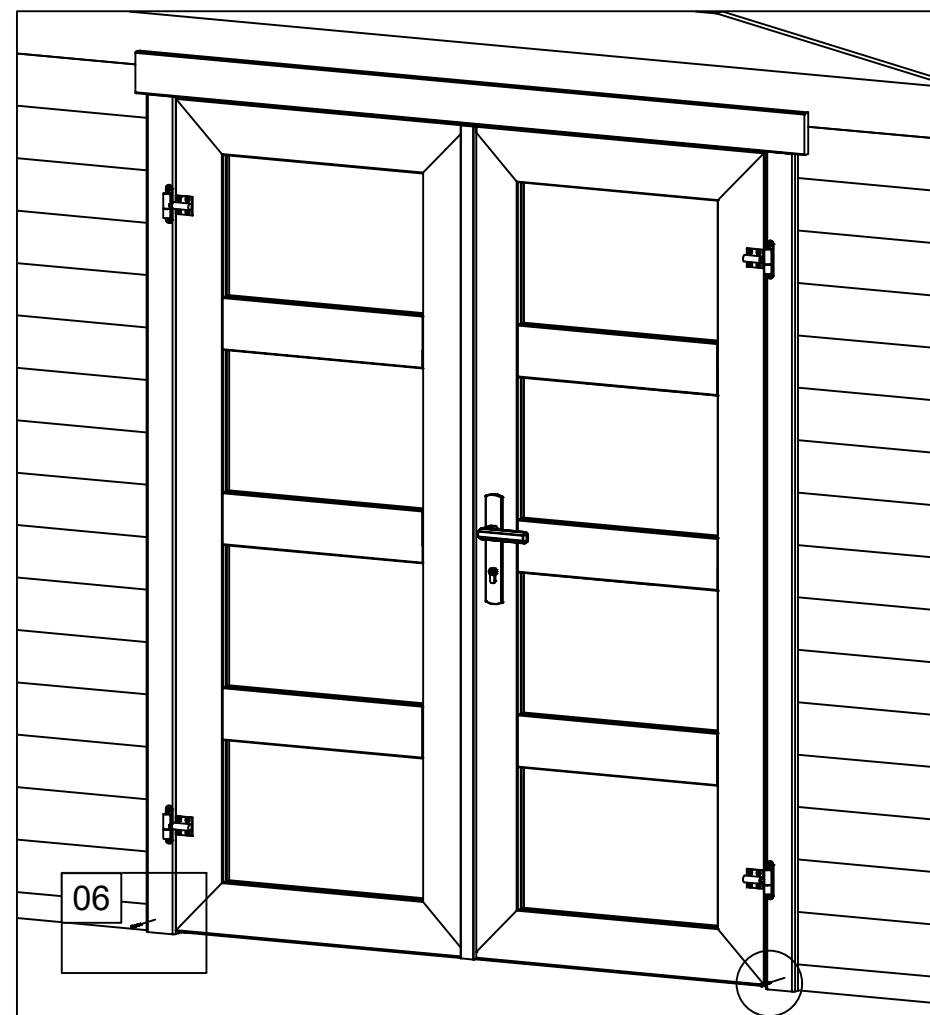
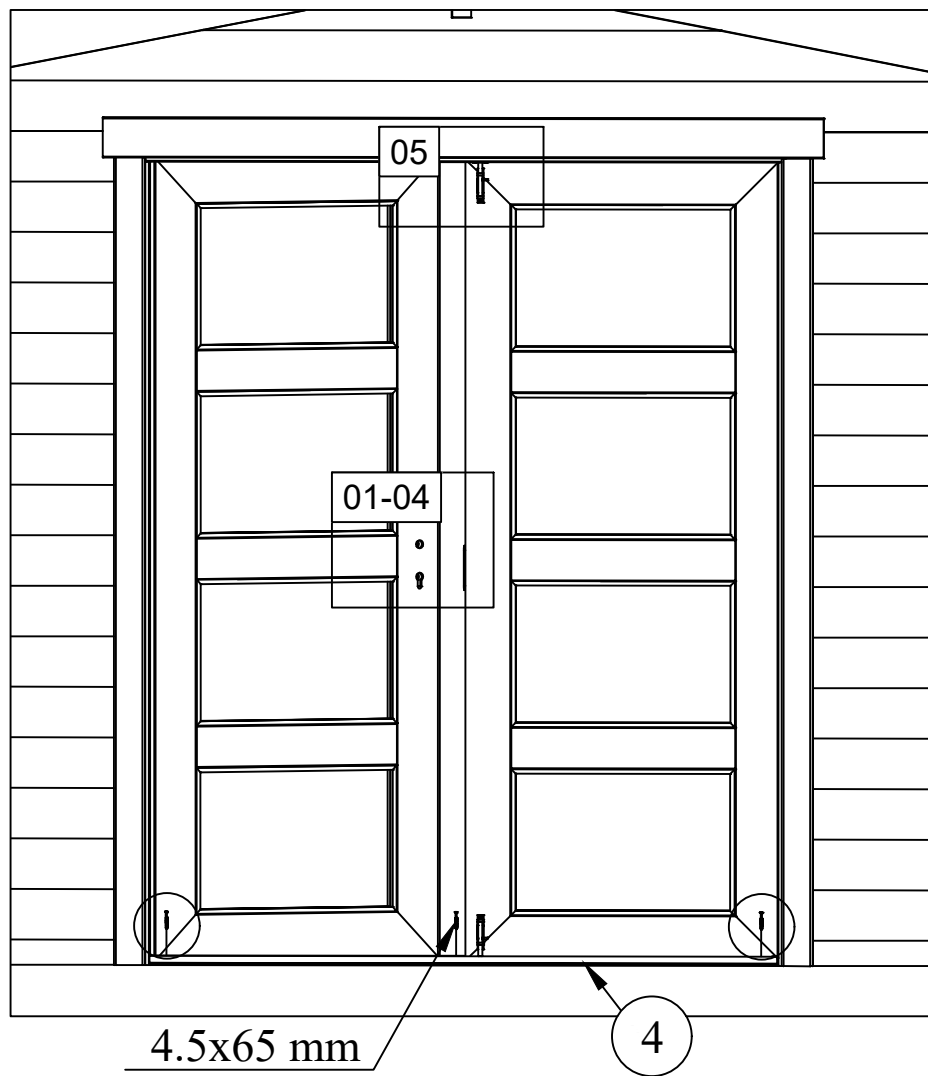

01

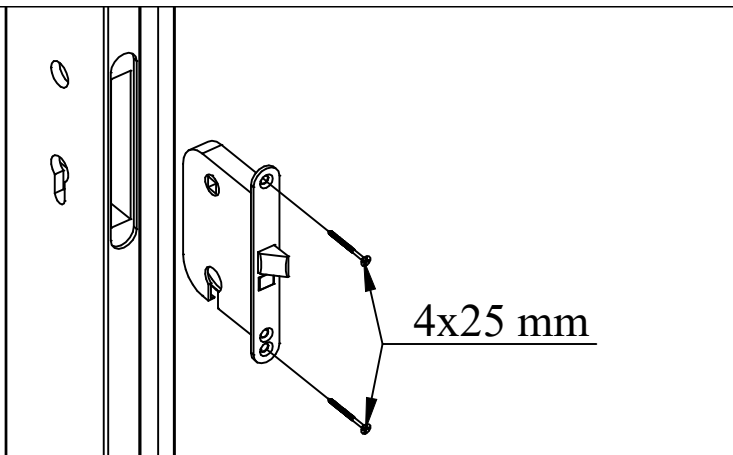

04



02



05



03



06

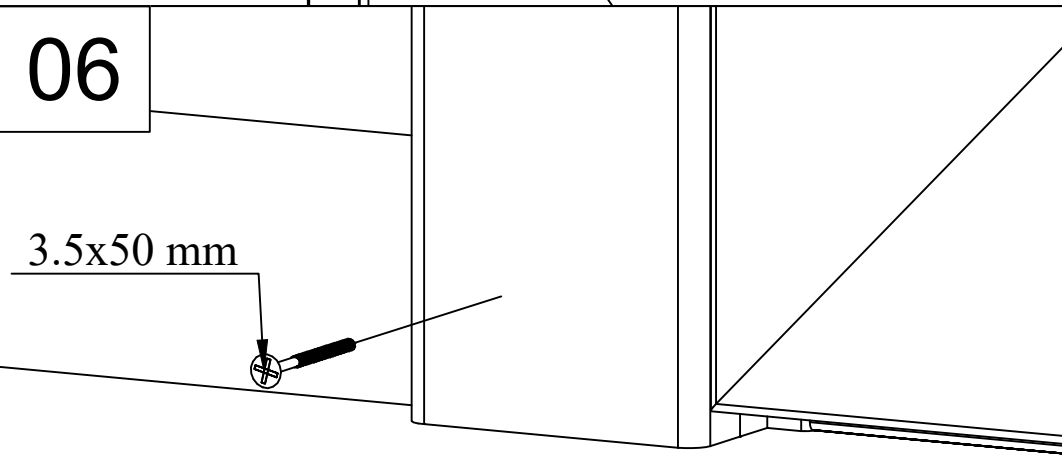

Art.Nr. 2847096

