

*Domeo 6 Loggia*  
*Art. Nr. 4426019*  
*1/30*

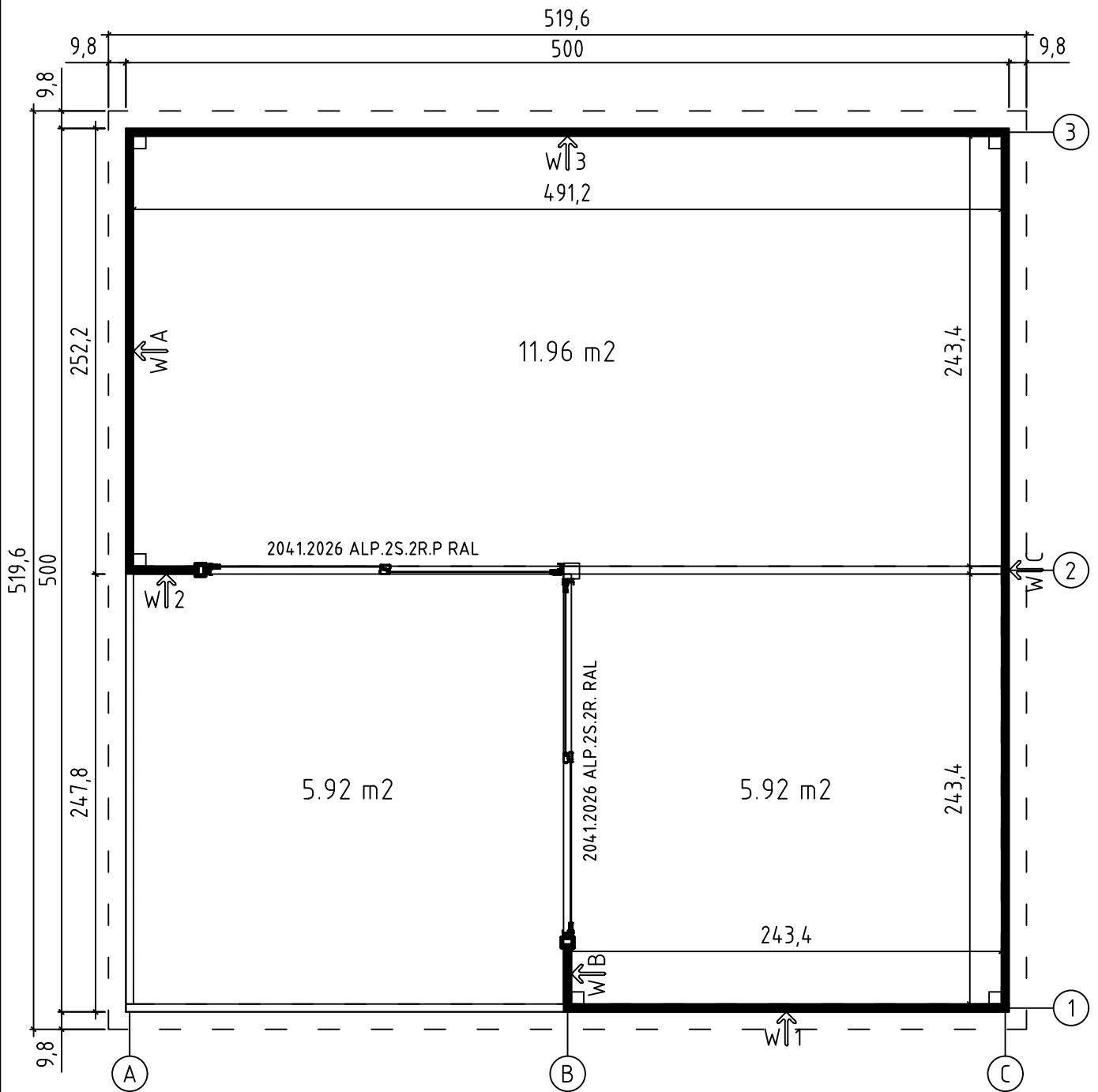

12.07.2023

Groundplan - Grundplan - Plan de masse -  
Planimetria - Plattegrond - Põhiplaan



Foundation - Fundament - Fondation - Fundamenta - Fundering -  
Immutatud alusraam

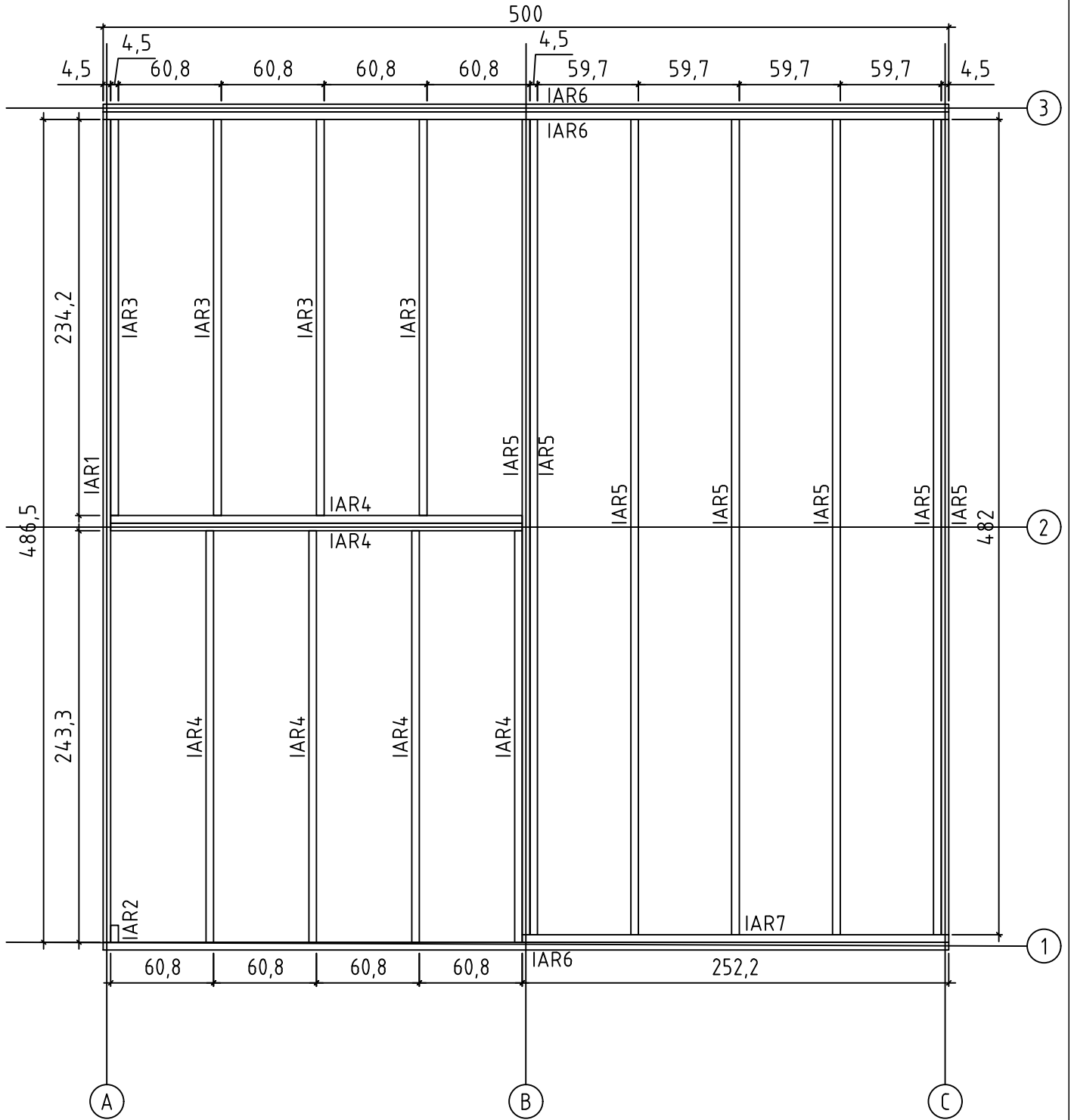

Art. Nr. 4426019

Floor boards - Fussbodenbretter - Plan pose plancher - Pavimento  
- Vloerhout - Põrandalaudis

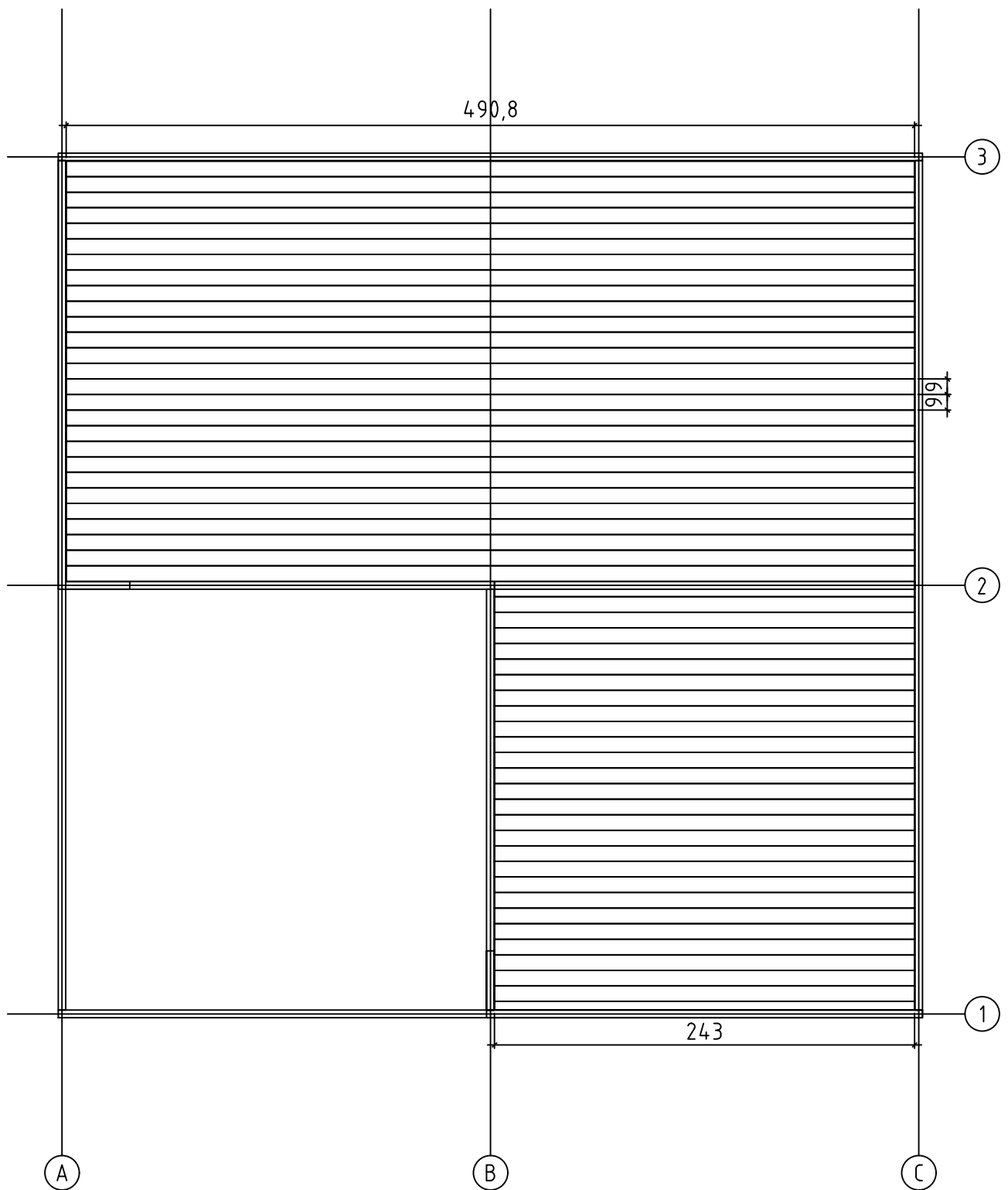

Art. Nr. 4426019

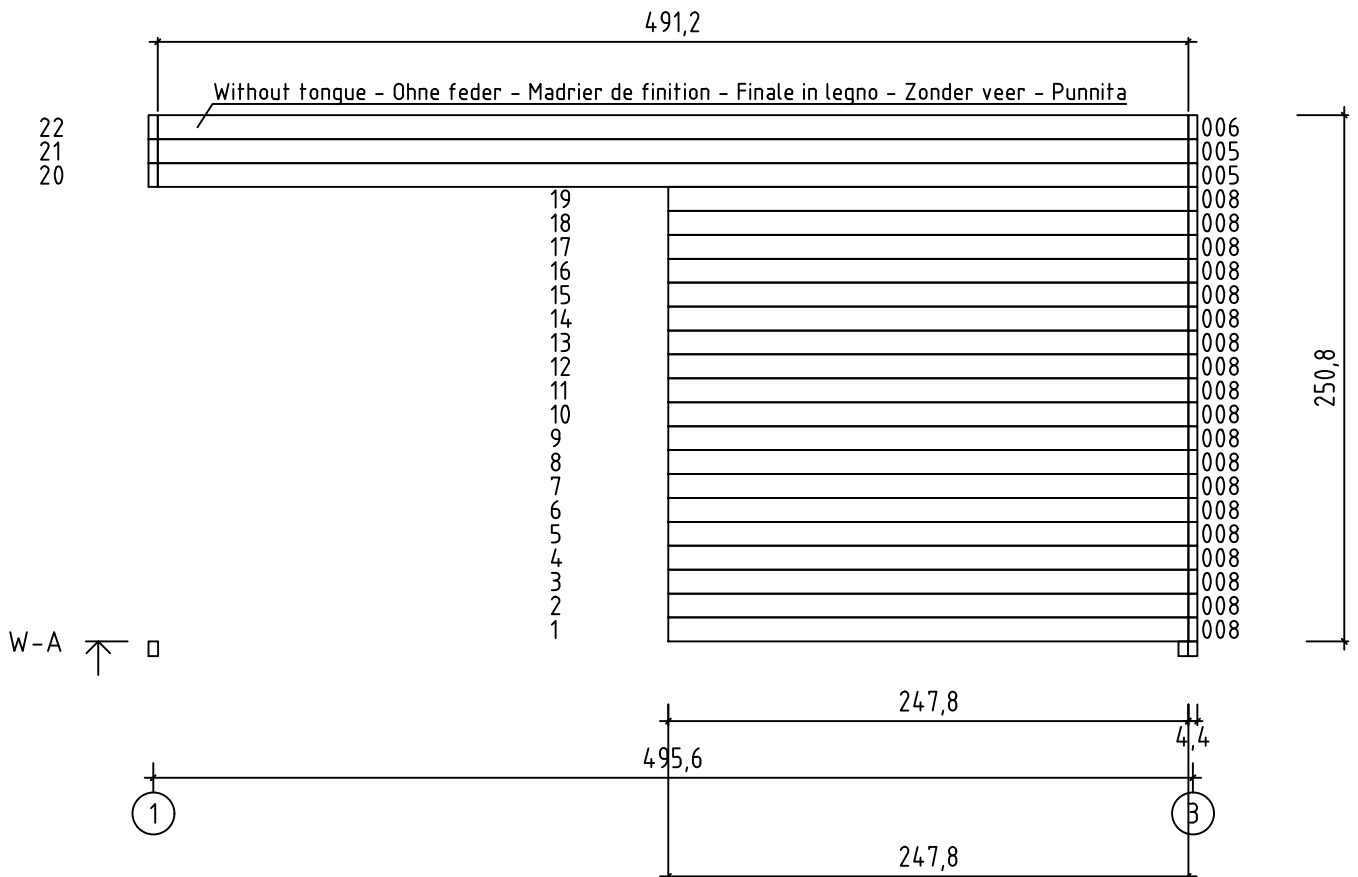
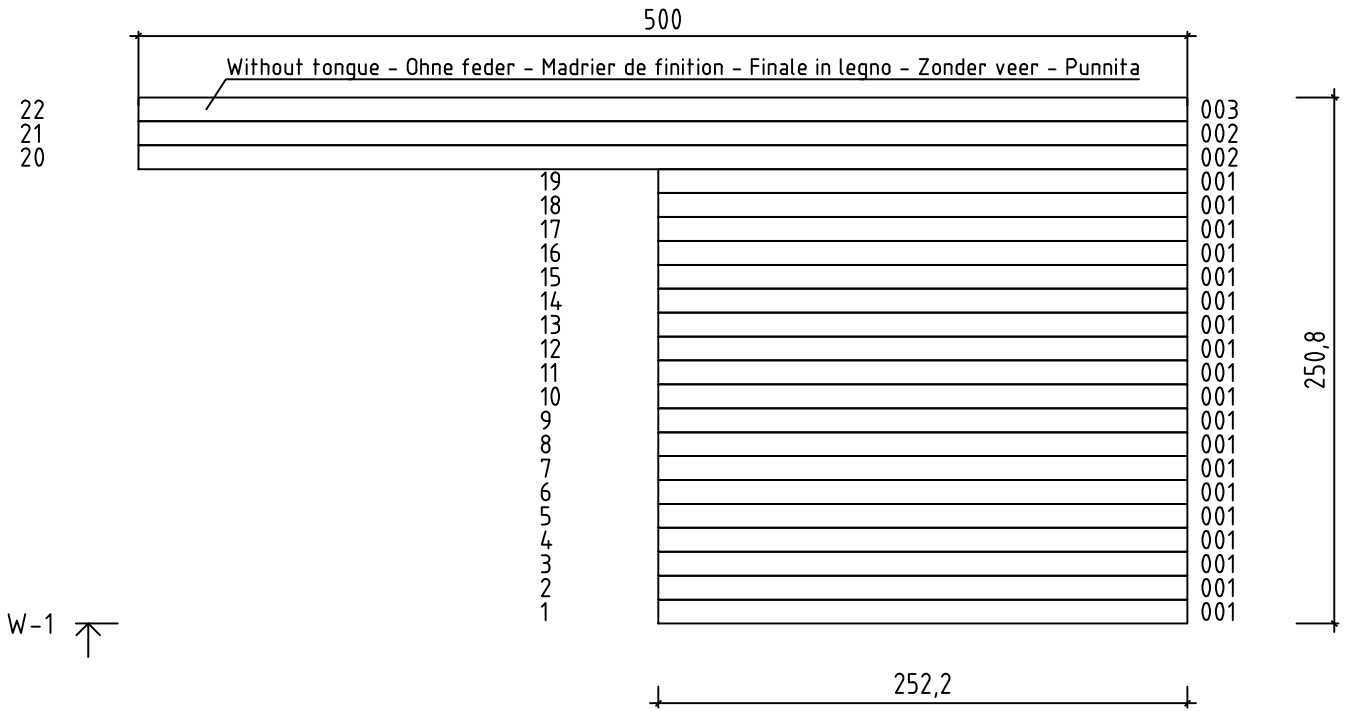



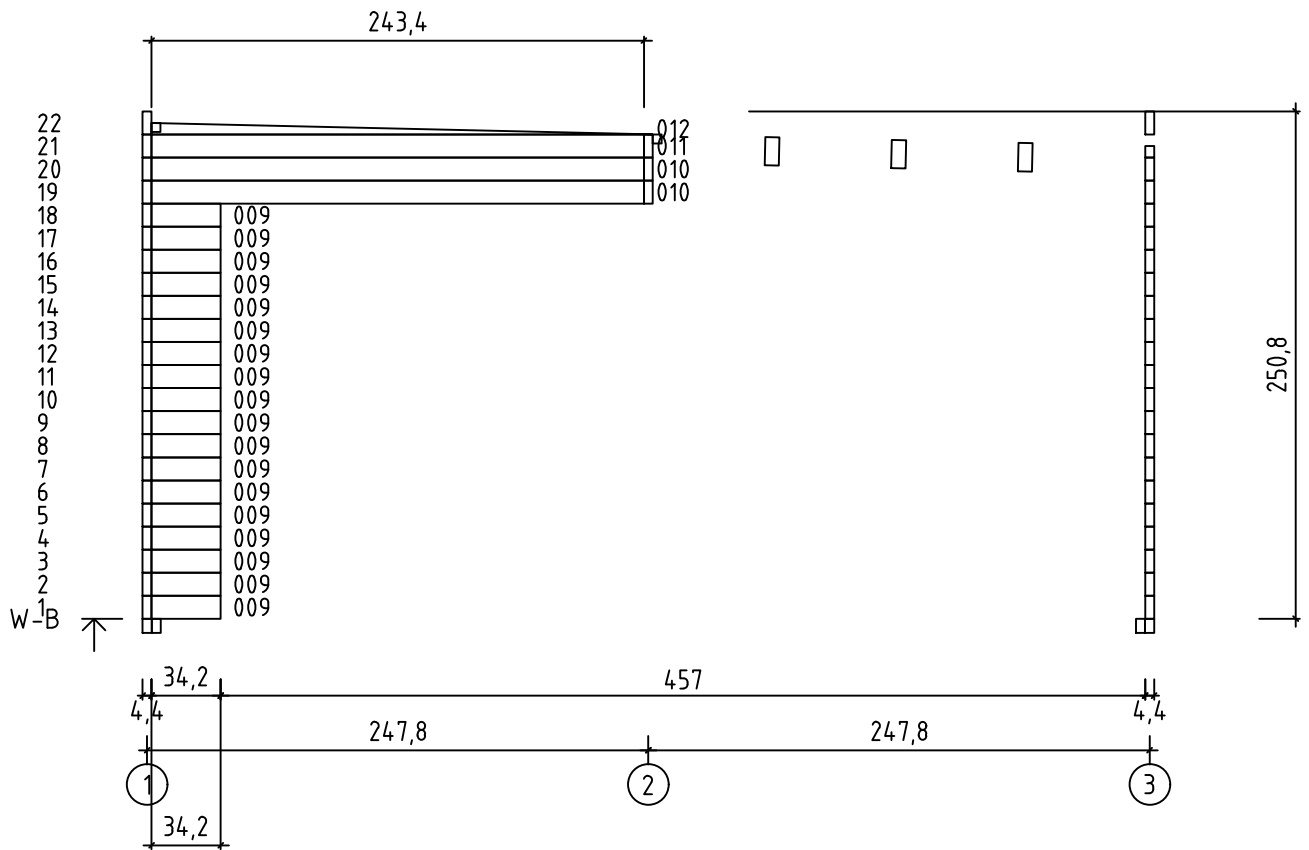
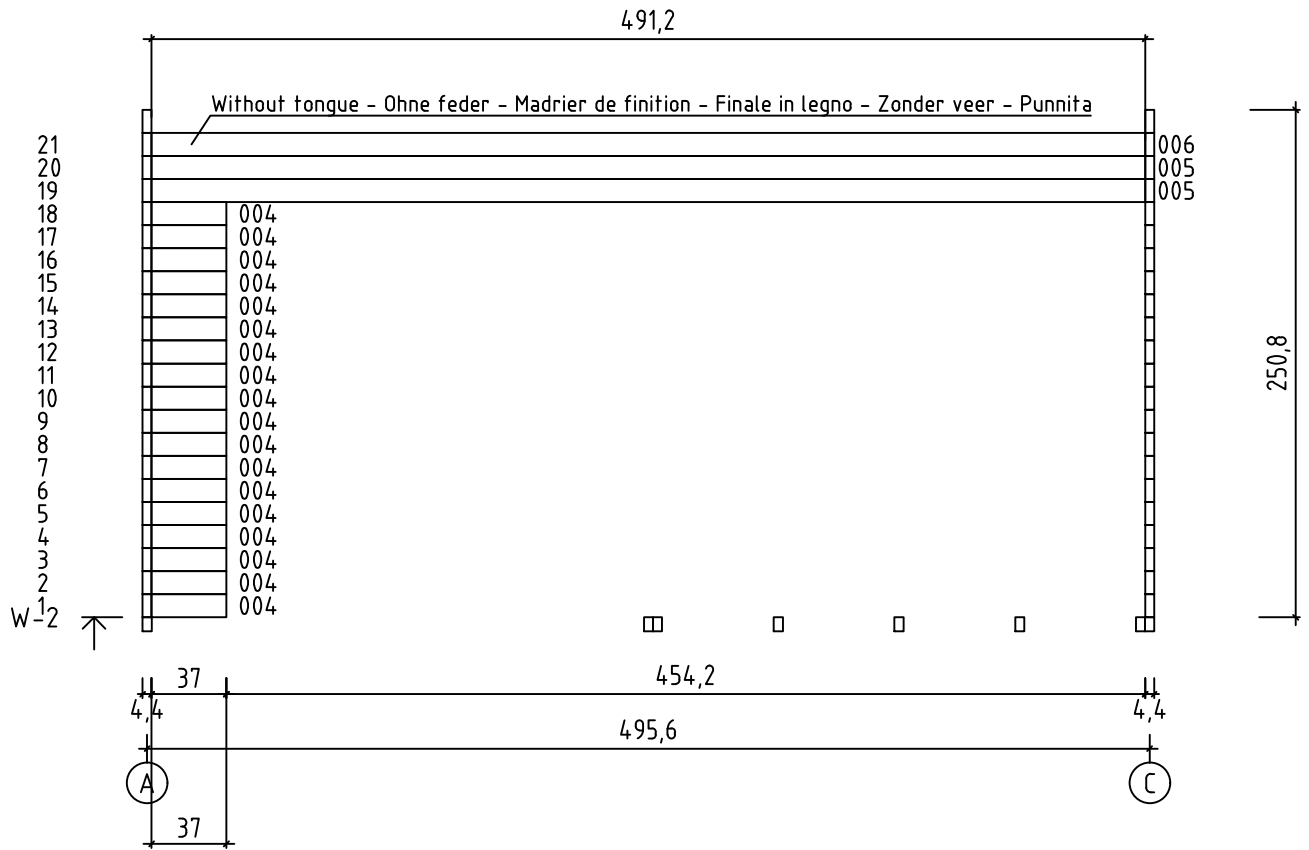



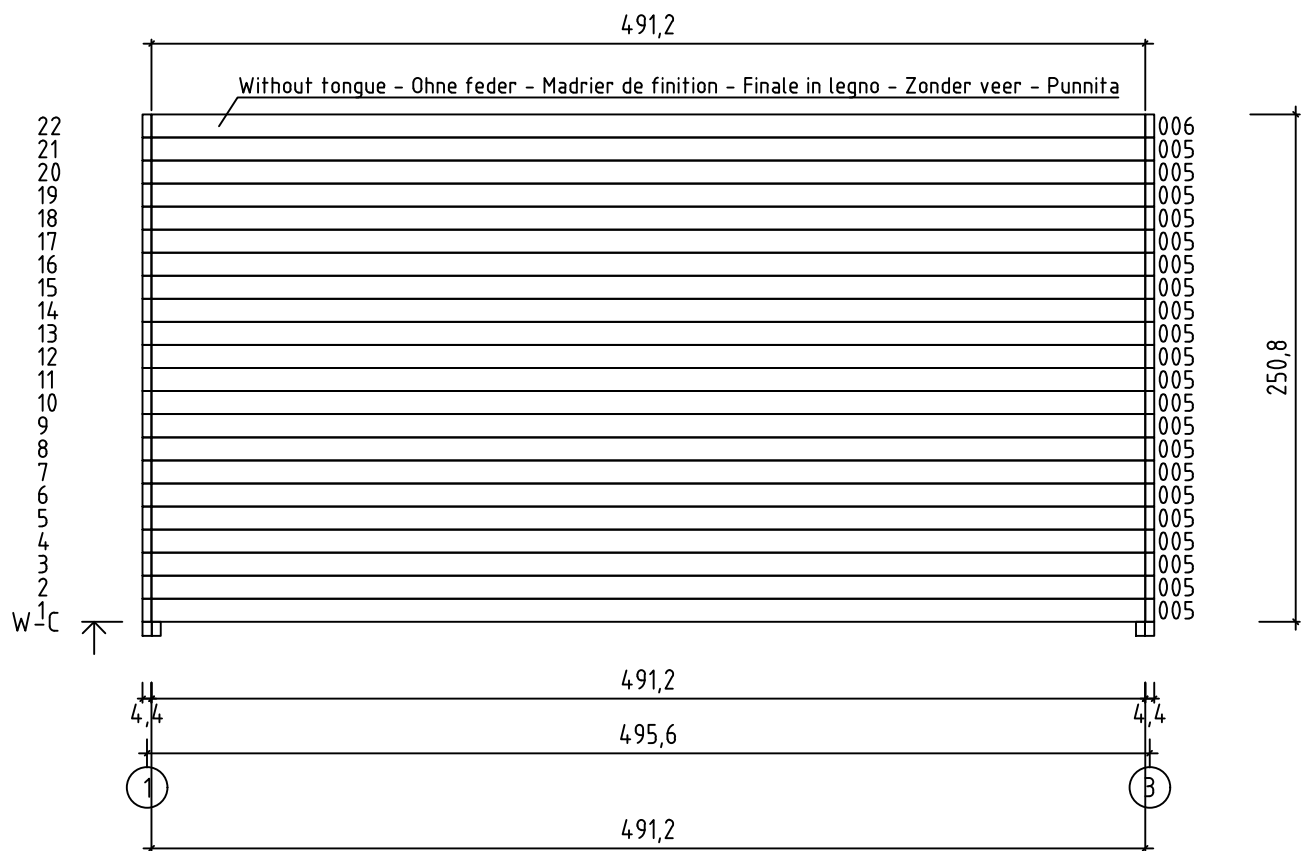
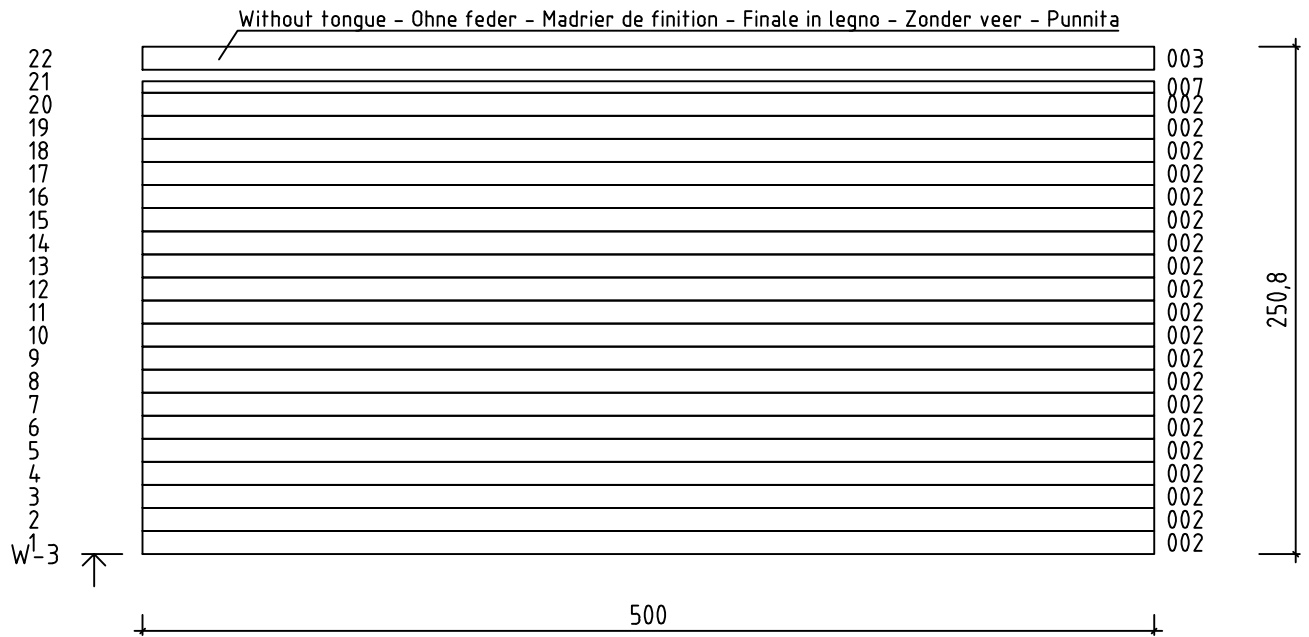

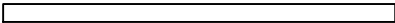
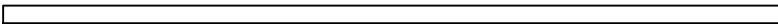
Art. Nr. 4426019

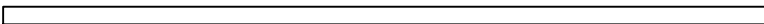
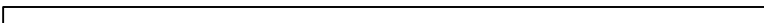
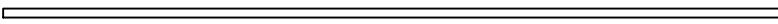
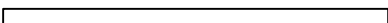

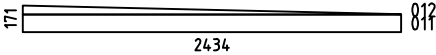
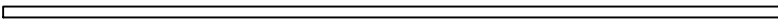
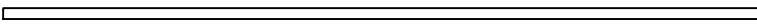
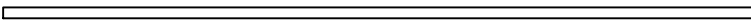
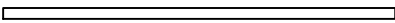
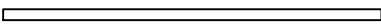
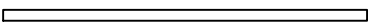



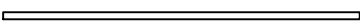
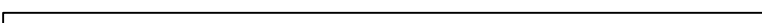
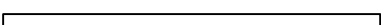







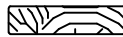
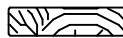

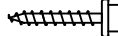

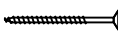



# Art. Nr. 4426019

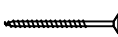
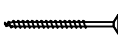

| Pos   | 12.07.2023 Piece list - Stückliste - Liste des pièces - Elementi - Stuklijst - Tükítabel<br>Art. Nr. 4426019 8/30  | Q  | P<br>(mm) | L<br>(mm) |
|-------|--|----|-----------|-----------|
| 001   |   | 19 | 44x114    | 2522      |
| 002   |    | 22 | 44x114    | 5000      |
| 003   |    | 2  | 44x114    | 5000      |
| 004   |   | 18 | 44x114    | 370       |
| 005   |    | 25 | 44x114    | 4912      |
| 006   |    | 3  | 44x114    | 4912      |
| 007   |    | 1  | 44x57     | 5000      |
| 008   |   | 19 | 44x114    | 2478      |
| 009   |   | 18 | 44x114    | 342       |
| 010   |   | 2  | 44x114    | 2434      |
| WB-1  |   | 1  |           |           |
| IAR6  | Foundation - Fundament - Fondation - Fondamenta - Fundering - Immutatud alusraam<br>           | 3  | 45x70     | 5000      |
| IAR1  | Foundation - Fundament - Fondation - Fondamenta - Fundering - Immutatud alusraam<br>           | 1  | 45x70     | 4865      |
| IAR5  | Foundation - Fundament - Fondation - Fondamenta - Fundering - Immutatud alusraam<br>           | 7  | 45x70     | 4820      |
| IAR7  | Foundation - Fundament - Fondation - Fondamenta - Fundering - Immutatud alusraam<br>            | 1  | 45x70     | 2522      |
| IAR4  | Foundation - Fundament - Fondation - Fondamenta - Fundering - Immutatud alusraam<br>            | 6  | 45x70     | 2433      |
| IAR3  | Foundation - Fundament - Fondation - Fondamenta - Fundering - Immutatud alusraam<br>            | 4  | 45x70     | 2342      |
| IAR2  | Foundation - Fundament - Fondation - Fondamenta - Fundering - Immutatud alusraam<br>            | 1  | 45x70     | 100       |
| RV1   | Lath - Pfetten - Liteau - Piccola asse - Gordingen - Roov<br>                                  | 1  | 44x44     | 4798      |
| RV2   | Lath - Pfetten - Liteau - Piccola asse - Gordingen - Roov<br>                                   | 1  | 44x44     | 2434      |
| RV3   | Lath - Pfetten - Liteau - Piccola asse - Gordingen - Roov<br>                                   | 1  | 44x44     | 2294      |
| A-PR1 | Roof beam - Dachbalken - Panne de toit - Perlina del tetto - Gordingen / dakbalk - Pärilin<br> | 3  | 70x140    | 4904      |
| A-PR2 | Roof beam - Dachbalken - Panne de toit - Perlina del tetto - Gordingen / dakbalk - Pärilin<br>  | 6  | 70x140    | 2426      |



| Pos  | 12.07.2023 Piece list - Stückliste - Liste des pièces - Elementi - Stuklijst - Tükítabel<br>Art. Nr. 4426019 9/30   | Q  | P<br>(mm) | L<br>(mm) |
|------|---|----|-----------|-----------|
|      | Floor boards - Fussbodenbretter - Lame de plancher - Pavimento - Vloerhout<br>- Pörandalaud    | 27 | 90x18     | 4908      |
|      | Floor boards - Fussbodenbretter - Lame de plancher - Pavimento - Vloerhout<br>- Pörandalaud    | 28 | 90x18     | 2430      |
|      | Terrace boards - Terrassenbretter - Plancher de terrasse - Piattaforme<br>terrazzo - Terrasvloer - Terrasilaud   | 27 | 90x19     | 2474      |
| DB1  | Roof boards - Dachbretter - Voliges - Perlina per tetto - Dakhout -<br>Katuselaud    | 55 | 90x18     | 2571      |
| DB2  | Roof boards - Dachbretter - Voliges - Perlina per tetto - Dakhout -<br>Katuselaud    | 55 | 90x18     | 2479      |
|      | Floor fillet - Fussbodenleiste - Corniere de finition du plancher - Finitura per<br>pavimento (battisco pa) - Vloerafwerkljst - Pörandaliist                             |    | 18x18     | 20        |
| DPL1 | Roofing felt fillet - Dachpappenleiste - Baguette de fixation du feutre<br>bitumeux - Asse per fissaggio guaina bituminosa - Afdekljst asfaltpapier -<br>Katusepapiiist  | 4  | 18x58     | 2540      |
| DPL2 | Roofing felt fillet - Dachpappenleiste - Baguette de fixation du feutre<br>bitumeux - Asse per fissaggio guaina bituminosa - Afdekljst asfaltpapier -<br>Katusepapiiist  | 4  | 18x58     | 2598      |
| FL1  | Fixing fillet - Fixierungsleiste - Profil de fixation - Massello di fissaggio -<br>Bevestiging lijstwerk - Tenderliist   | 1  | 28x34     | 342       |
| RS2  | Railing strip - Begrenzungsleiste - Rembarde - Sbarra - Afscheidingslijst -<br>Piirdelaud   | 2  | 18x70     | 1982      |
| RS4  | Railing strip - Begrenzungsleiste - Rembarde - Sbarra - Afscheidingslijst -<br>Piirdelaud    | 2  | 18x70     | 2000      |
| RS7  | Railing strip - Begrenzungsleiste - Rembarde - Sbarra - Afscheidingslijst -<br>Piirdelaud    | 2  | 18x90     | 2116      |
| RS8  | Railing strip - Begrenzungsleiste - Rembarde - Sbarra - Afscheidingslijst -<br>Piirdelaud    | 2  | 18x90     | 2126      |
| FL2  | Post - Pfosten - Poteau - Piede registrabile - Stijl - Post    | 2  | 44x44     | 330       |
| P1   | Post - Pfosten - Poteau - Piede registrabile - Stijl - Post    | 2  | 70x70     | 2337      |
| P2   | Post - Pfosten - Poteau - Piede registrabile - Stijl - Post    | 1  | 70x70     | 2394      |
| P3   | Post - Pfosten - Poteau - Piede registrabile - Stijl - Post    | 2  | 70x70     | 2452      |
| P4   | Post - Pfosten - Poteau - Piede registrabile - Stijl - Post    | 1  | 90x90     | 2052      |
| P5   | Post - Pfosten - Poteau - Piede registrabile - Stijl - Post    | 1  | 90x90     | 2360      |
| DRV1 | Roof edge reinforcement - Dachrandverstärkung - Corniere de renfort de bord<br>de toit - Rinforzo x tetto - Dakrand versterking - Räästatugevdus                       | 4  | 80x44     | 2500      |
| DRV2 | Roof edge reinforcement - Dachrandverstärkung - Corniere de renfort de bord<br>de toit - Rinforzo x tetto - Dakrand versterking - Räästatugevdus                       | 4  | 80x44     | 2580      |
| FF2  | Fixing fillet - Fixierungsleiste - Profil de fixation - Massello di fissaggio -<br>Bevestiging lijstwerk - Tenderliist   | 2  | 15x45     | 2026      |
| FF   | Fixing fillet - Fixierungsleiste - Profil de fixation - Massello di fissaggio -<br>Bevestiging lijstwerk - Tenderliist   | 2  | 18x44     | 2030      |

| Pos  | 12.07.2023   | Piece list - Stückliste - Liste des pièces - Elementi - Stuklijst - Tükítabel<br>Art. Nr. 4426019 | 10/30 | Q      | P<br>(mm) | L<br>(mm) |
|------|--|---|-------|--------|-----------|-----------|
| FF3  | Fixing fillet - Fixierungsleiste - Profil de fixation - Massello di fissaggio - Bevestiging lijstwerk - Tenderliist  |                | 2     | 38x46  | 1980      |           |
| FF4  | Fixing fillet - Fixierungsleiste - Profil de fixation - Massello di fissaggio - Bevestiging lijstwerk - Tenderliist  |                | 2     | 38x46  | 2026      |           |
| GL1  | Gable moulding - Giebelleiste - Planche de rive - Finitura per frontale e retro del tetto - Gevellijst - Viilulaud   |                | 4     | 18x120 | 2580      |           |
| GL2  | Gable moulding - Giebelleiste - Planche de rive - Finitura per frontale e retro del tetto - Gevellijst - Viilulaud   |                | 4     | 18x120 | 2598      |           |
| ES-1 | Fascia sheet - Abschlussprofil - Profil de finition métallique pour débord de toiture - Scossalina di protezione dall'acqua per bordo di legno - Afdek profiel / boordprofiel - Räästaplekk  |                | 8     |        | 2650      |           |
| HS15 | Screw for fascia sheet - Schraube für abschlussprofil - Vis pour profil de finition métallique pour débord de toiture - Viti per fissare i folgi di gronda - Schroef voor afsluit (afdek)profiel - Tornillo de tejado - Katusekruvi  |                | 120   | 4.8x25 |           |           |
| HS34 | Screw for wall details - Schraube für wand details - Vis pour mur details - Viti per elementi della porta - Schroef voor wand details - Krugi seinte montaažiks  |                | 500   | 5x80   |           |           |
| HS10 | Screw for door jamb - Schraube für türrahmen - Vis de fixation partie haute avec montants du cadre de porte - Viti x fissaggio montanti porte - Schroef voor deurkozijn - Krugi ukse lengile   |                | 8     | 4x25   |           |           |
| HS12 | Screw for doorstep - Schrauben für swelle - Vis pour fixation barre de seuil - Vite per soglia della porta - Schroef voor deurdorpel - Krugi lävepakule  |                | 6     | 4x40   |           |           |
| HS12 | Screw for metal corner - Holzschraube für metallwinkel - Vis de fixation des cornieres en métal - Viti per fissare suadretta di metallo di giunzione - Schroef voor metalen hoek - Krugi nurgikule   |               | 20    | 4x40   |           |           |
| HS12 | Screw for covering moulding - Schrauben für deckungsprofil - Vis de fixation profils horizontaux haut inférieur et extérieur d'encadrement de porte - Vite per cornice di copertura - Schroef voor afdekprofiel - Krugi piirdelauale                                       |              | 32    | 4x40   |           |           |
| HS12 | Screw for beam holder - Schrauben für balkenhalter - Vis de fixation support "u" galvanisé - Vite per trave di sostegno - Schroef voor bevestiging balkhouder (gordingschoen) - Krugi talakingale  |              | 216   | 4x40   |           |           |
| HS12 | Screw for fixing fillet of door and window - Schrauben für fixierungsleiste - Vis pour profil vertical de fixation pour ouvertures des fenestres et portes - Viti per massello di fissaggio - Schroeven voor bevestiging van deur en raam lijsten - Krugi tenderliisfudele |              | 36    | 4x40   |           |           |
| HS12 | Screw for door jamb - Schraube für türrahmen - Vis de fixation partie haute avec montants du cadre de porte - Viti x fissaggio montanti porte - Schroef voor deurkozijn - Krugi ukse lengile   |              | 12    | 4x40   |           |           |
| HS12 | Screw for gable moulding - Schrauben für giebelleiste - Vis pour fixation planche de rive - Vite per fissare finiture davanti e dietro del tetto - Schroef voor gevellijst - Krugi viilulauale   |              | 48    | 4x40   |           |           |
| HS13 | Screw for wall details - Schraube für wand details - Vis pour mur details - Viti per elementi della porta - Schroef voor wand details - Krugi seinadetailile   |              | 12    | 4x60   |           |           |
| HS33 | Screw for door jamb - Schraube für türrahmen - Vis de fixation partie haute avec montants du cadre de porte - Viti x fissaggio montanti porte - Schroef voor deurkozijn - Krugi ukse lengile   |              | 16    | 5x40   |           |           |
| HS16 | Screw for foundation - Schrauben zur befestigung fundament - Vis de fixations des poutrelles de fondations - Viti x fondamenta - Schroef voor fundering - Krugi alusraamile  |              | 60    | 5x90   |           |           |
| HS16 | Screw for post - Schrauben für pfosten - Vis de fixation des poteaux - Viti per inviare - Schroef voor stijlen - Krugi postile   |              | 12    | 5x90   |           |           |
| HS16 | Screw for roof edge reinforcement - Schrauben für dachrandverstärkung - Vis pour fixation corniere renfort de bord de toit - Viti x rinforzo bordo tetto - Schroef voor dakrand versterking - Krugi räästatugevdusele  |              | 40    | 5x90   |           |           |
| HS16 | Screw for door jamb - Schraube für türrahmen - Vis de fixation partie haute avec montants du cadre de porte - Viti x fissaggio montanti porte - Schroef voor deurkozijn - Krugi ukse lengile   |              | 10    | 5x90   |           |           |
| HS27 | Screw for post - Schrauben für pfosten - Vis de fixation des poteaux - Viti per inviare - Schroef voor stijlen - Krugi postile   |              | 8     | 6x120  |           |           |
| HS22 | Screw for 1. wall beam - Schraube für 1. bohlenreihe - Vis de fixations 1ere rangée de madriers avec poutrelles de fondations - Vite fissaggio alle fondamenta - Schroef voor 1 wandbalk - Krugi poollauale  |              | 12    | 6x150  |           |           |



Art. Nr. 4426019

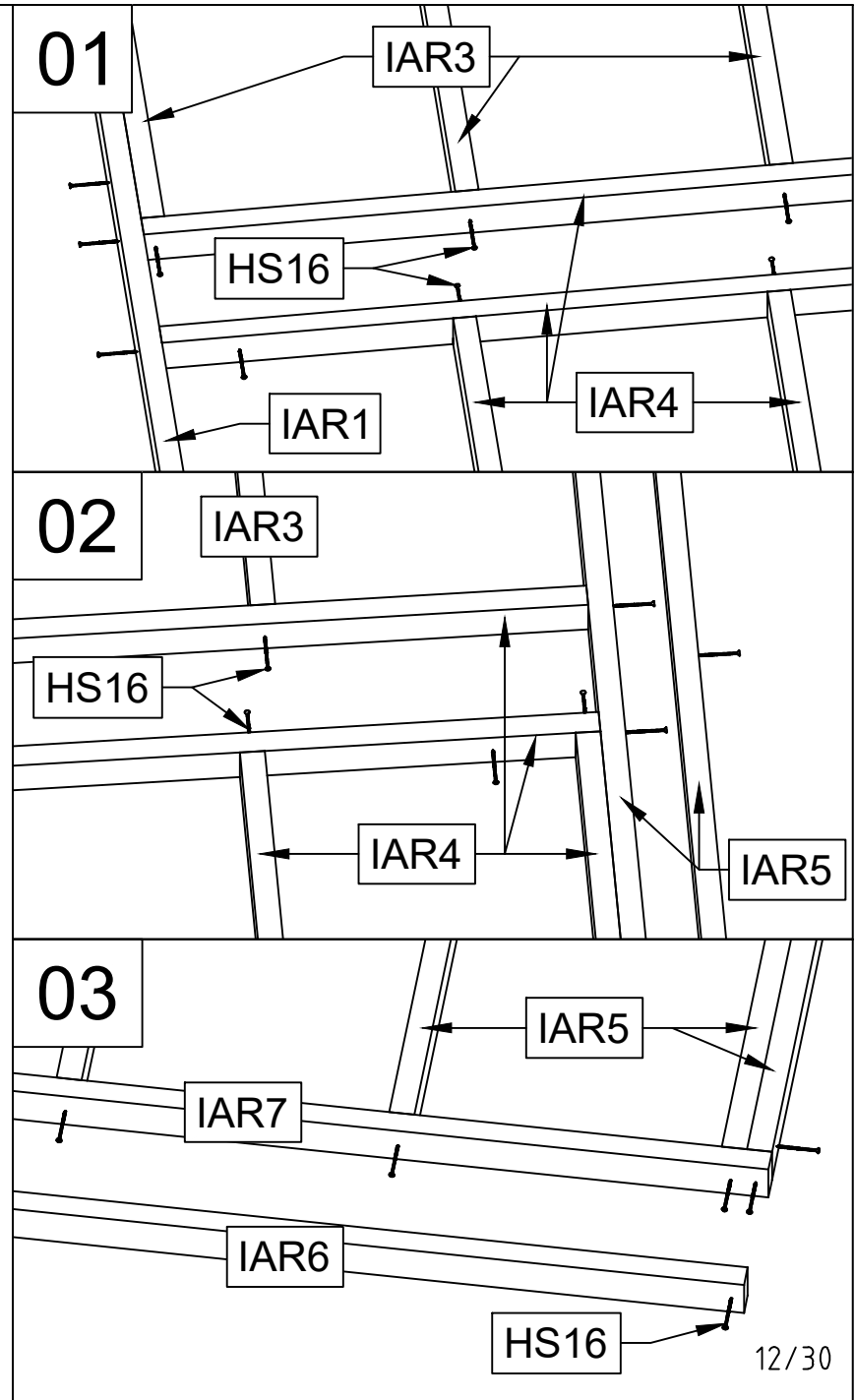
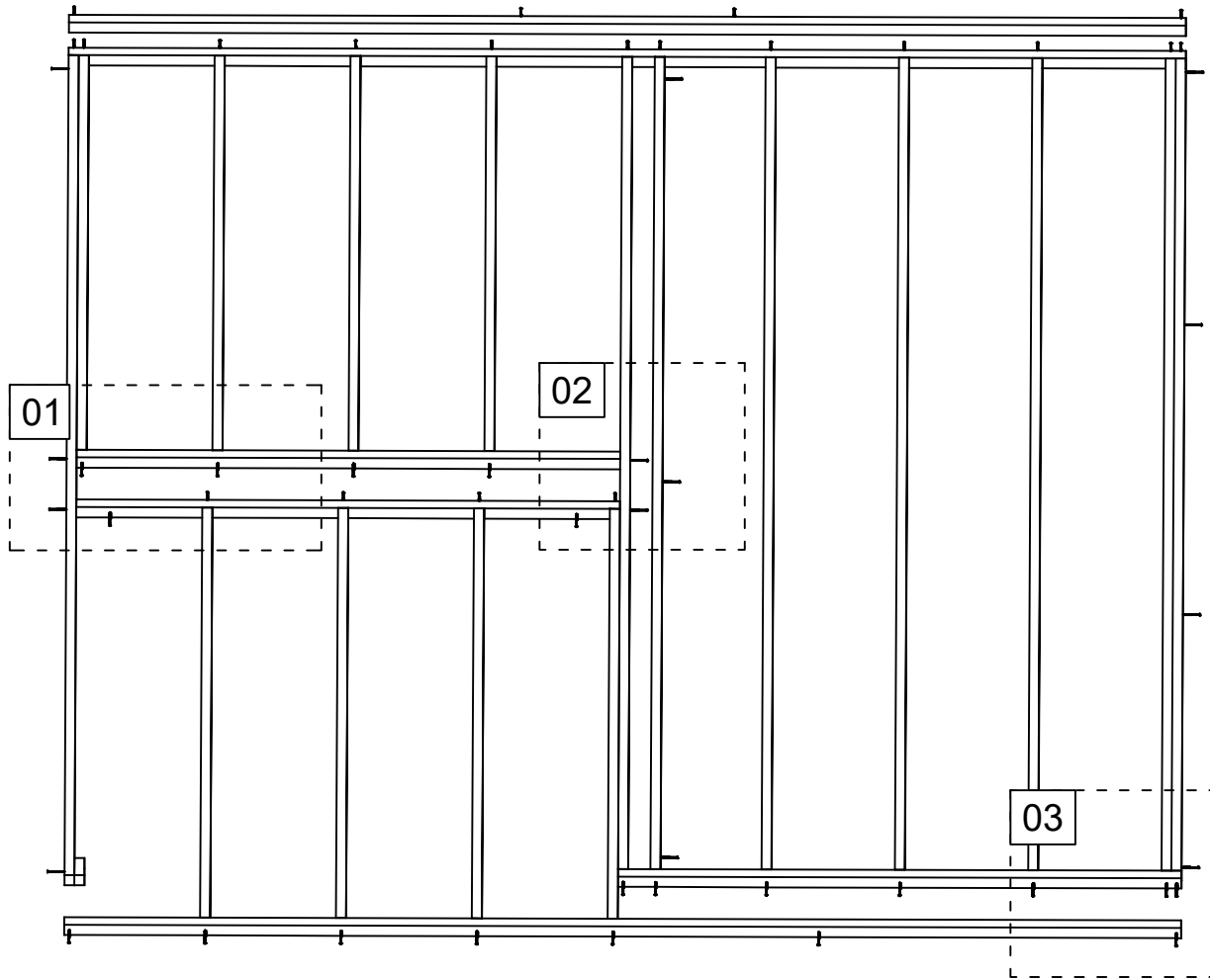

Art. Nr. 4426016

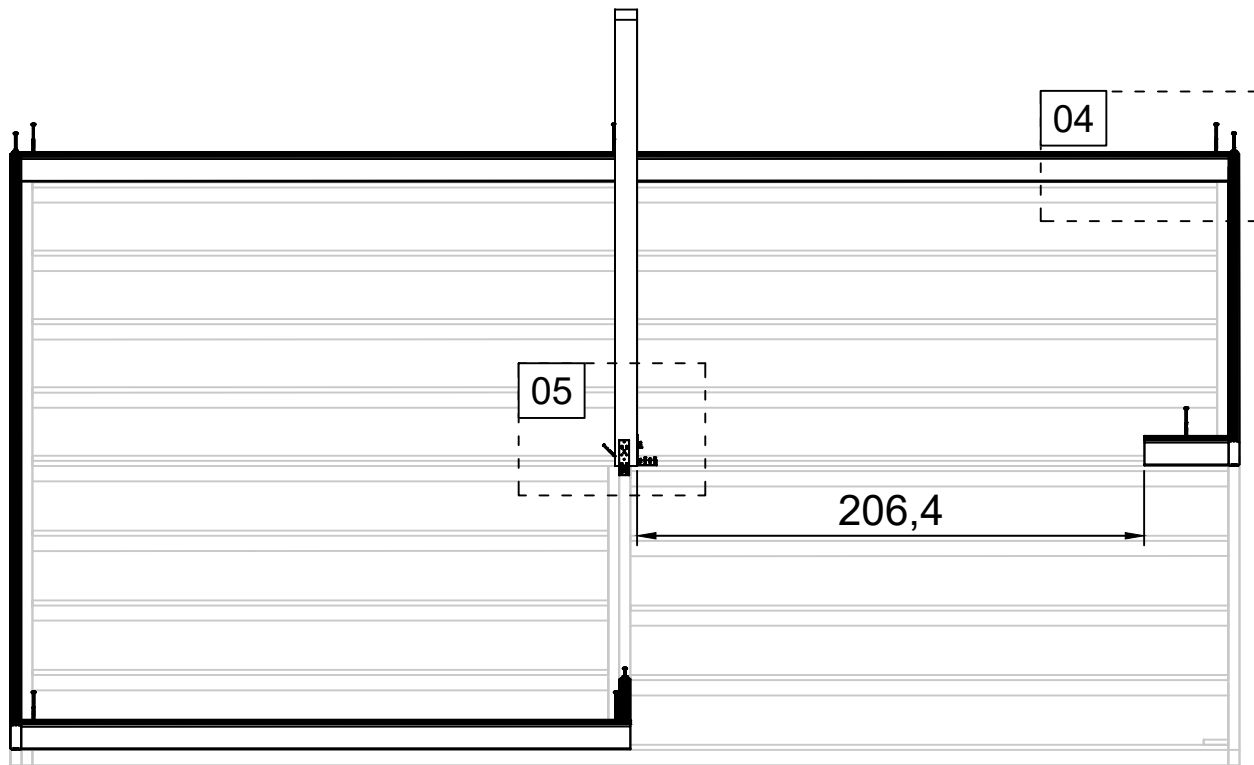

04

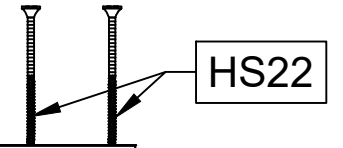

05

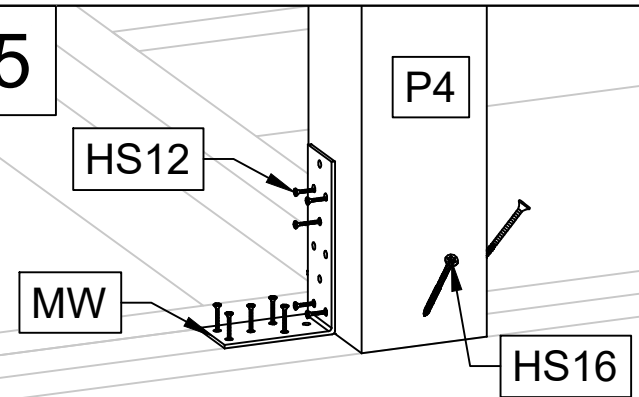

05

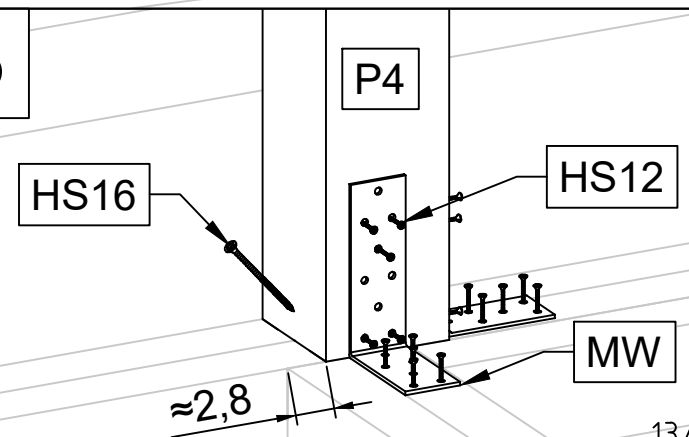

Art. Nr. 4426016

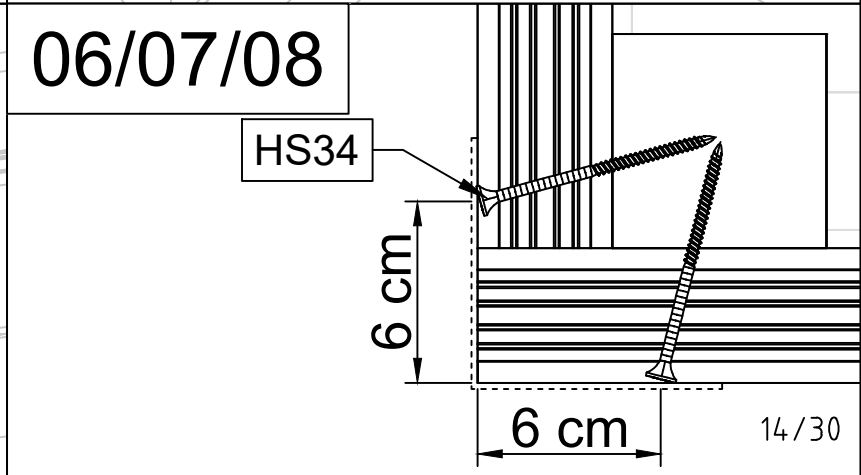
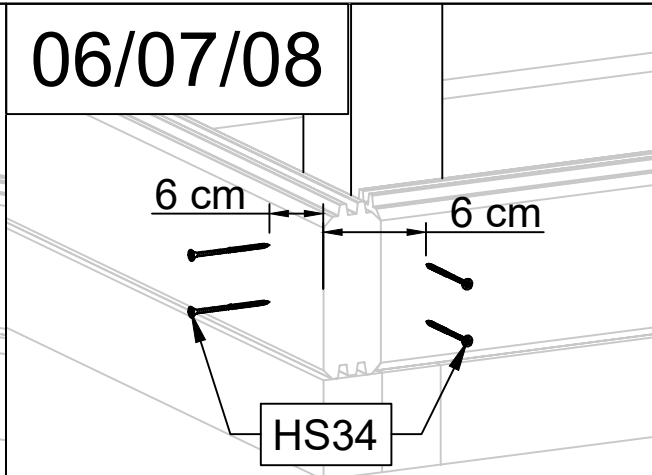
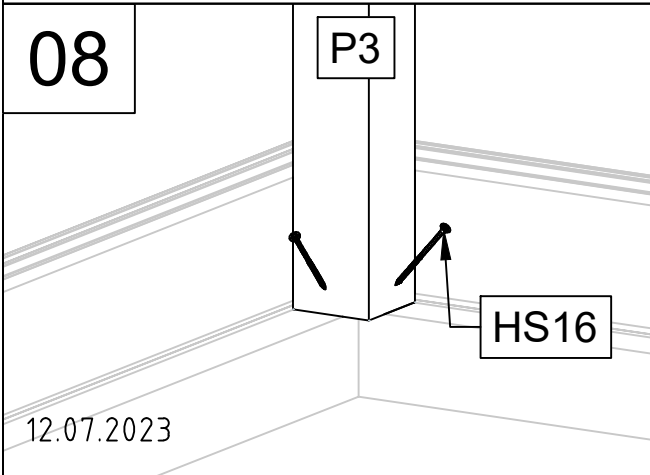
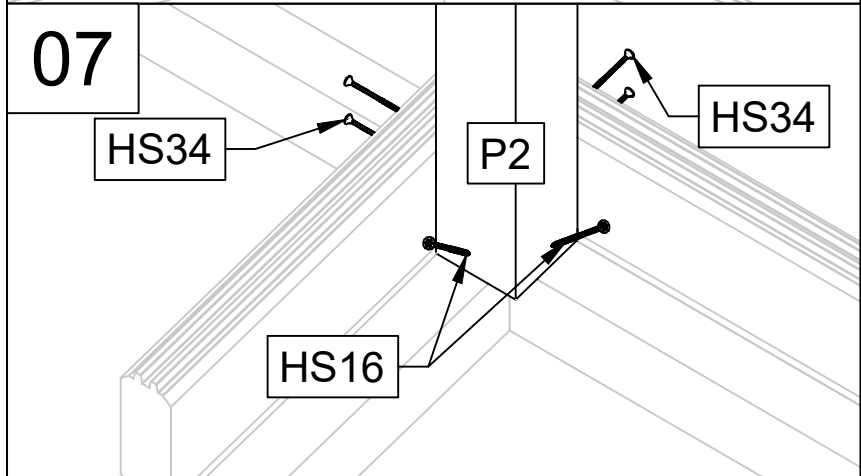
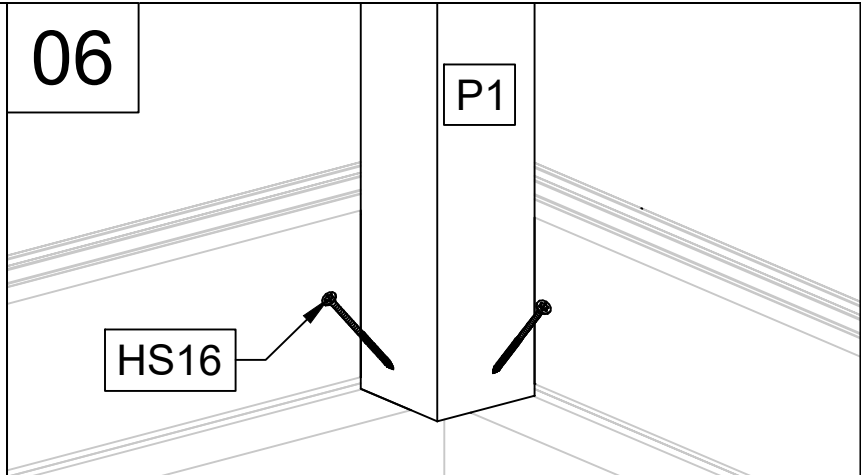
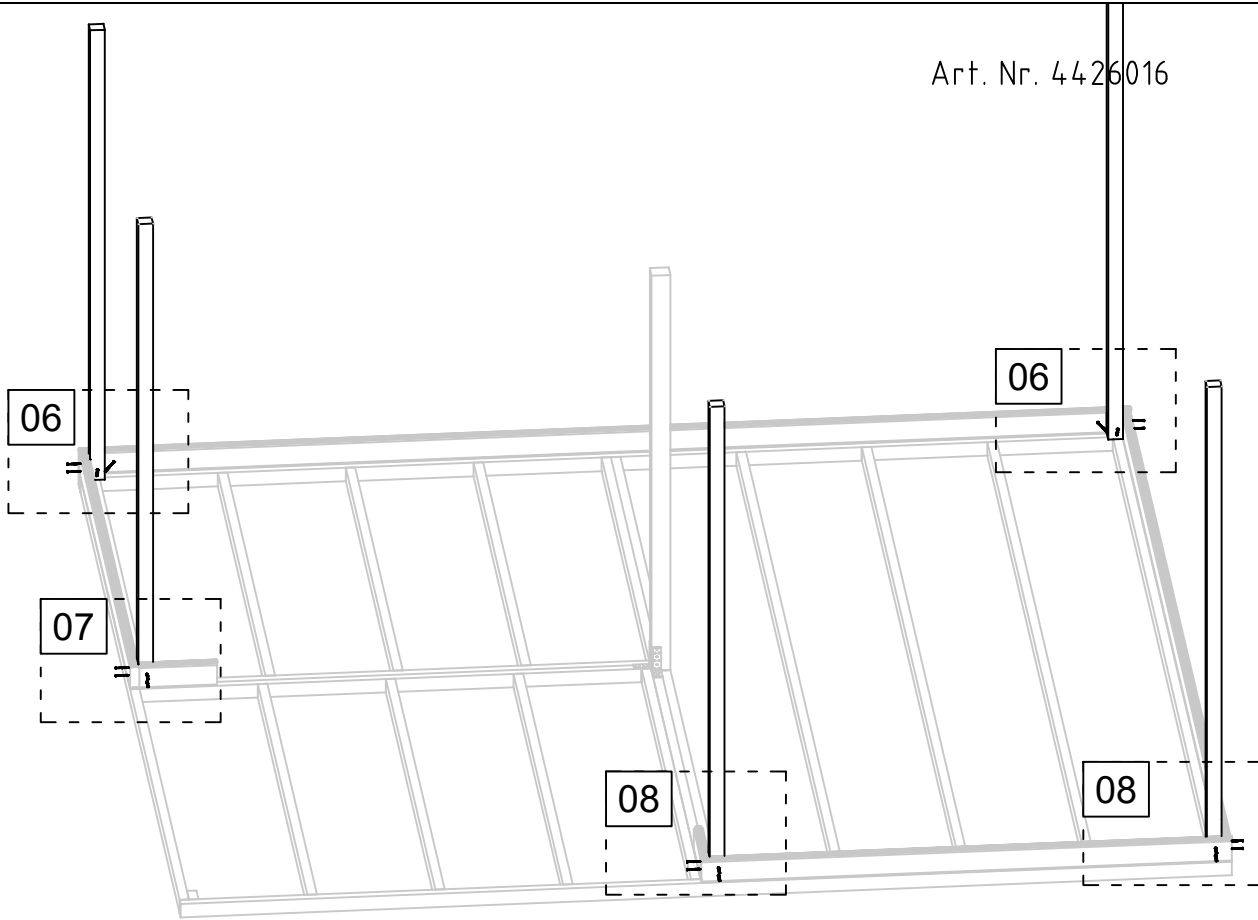

Art. Nr. 4426016

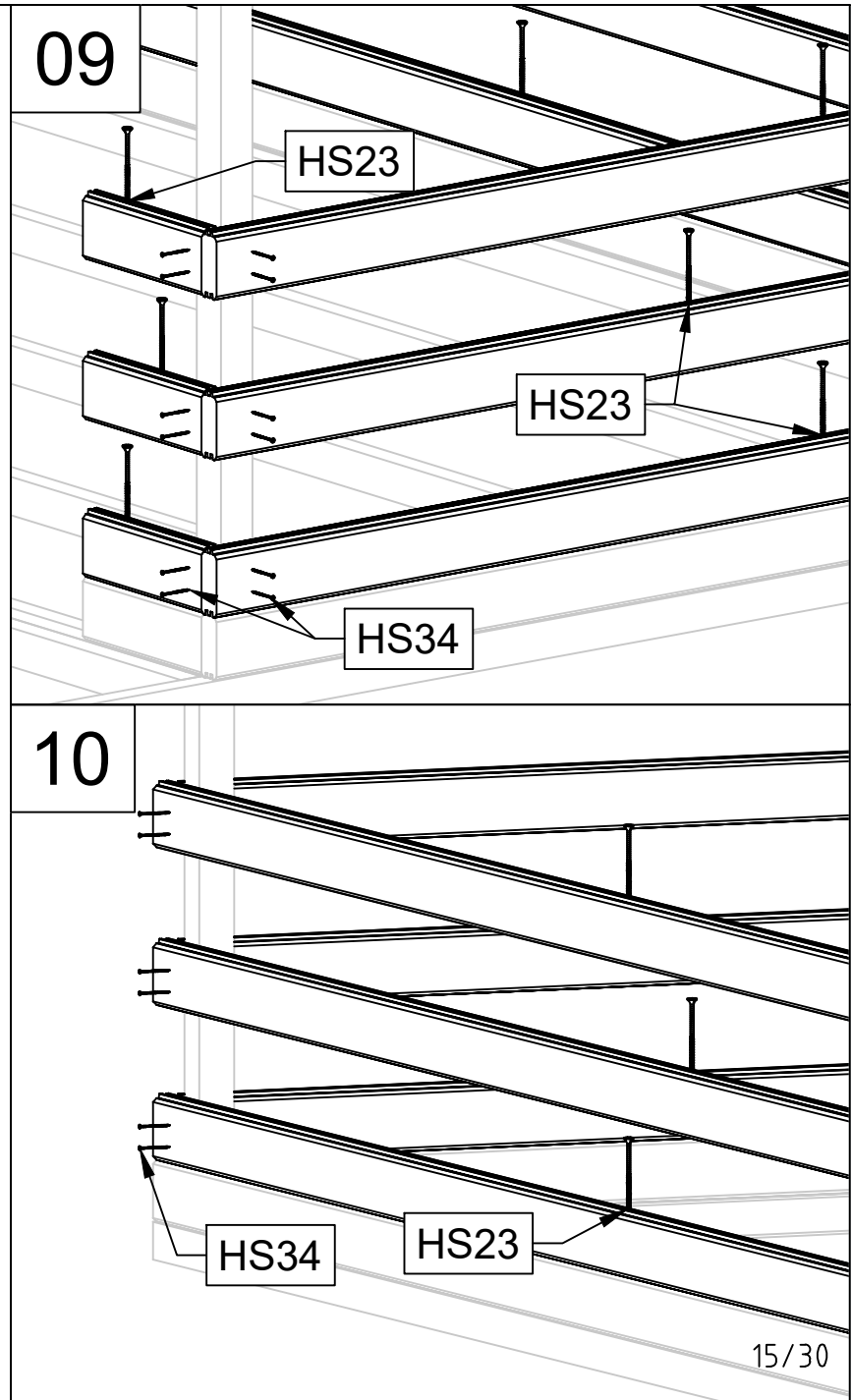
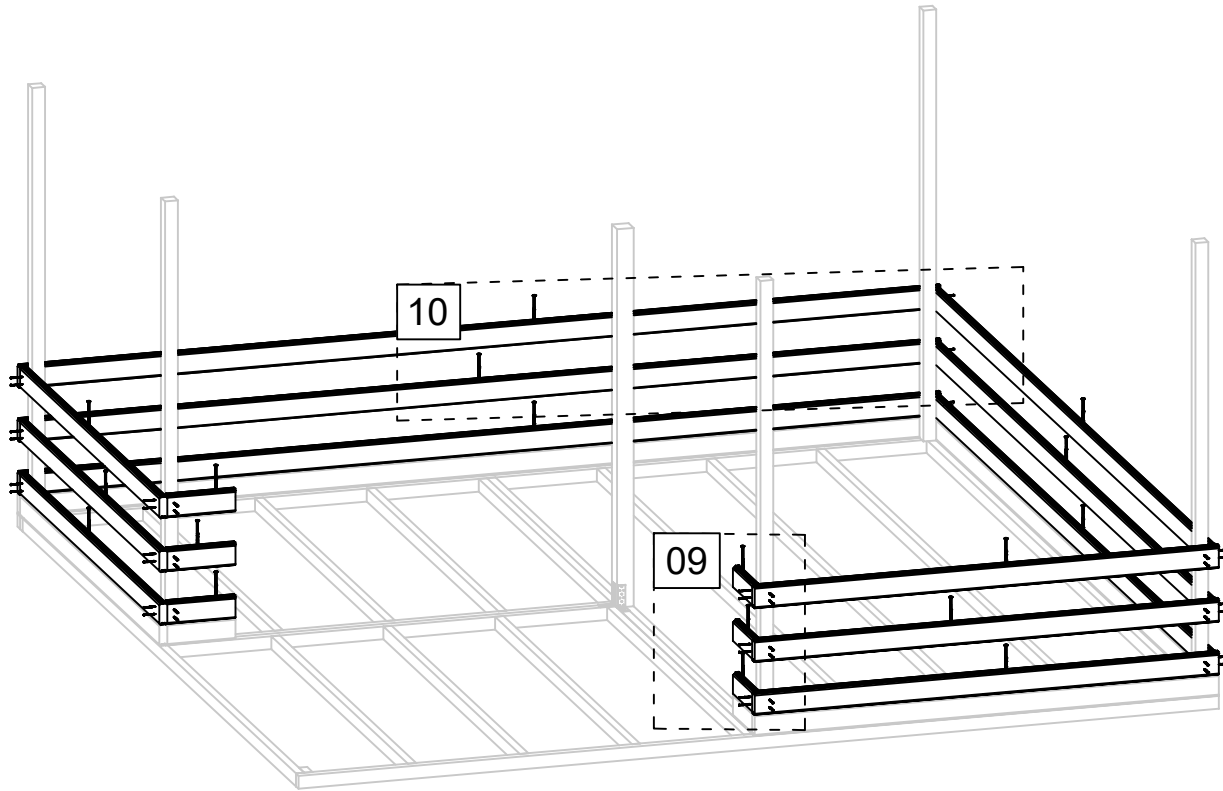

Art. Nr. 4426016

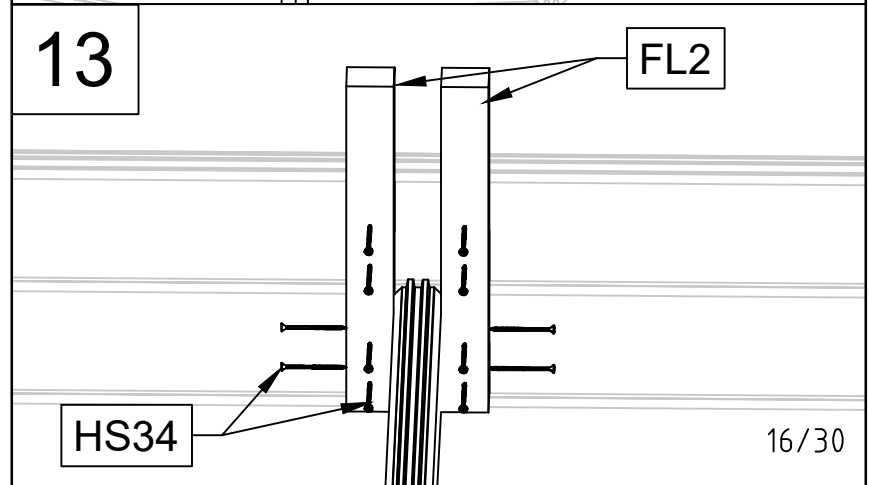
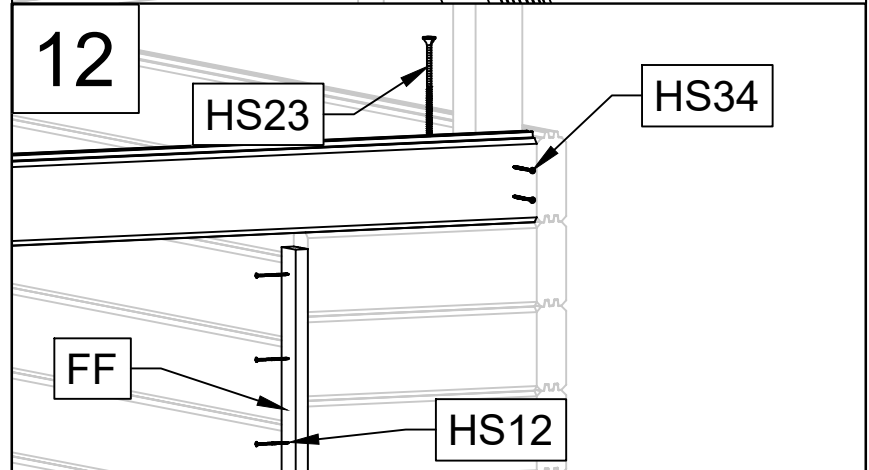
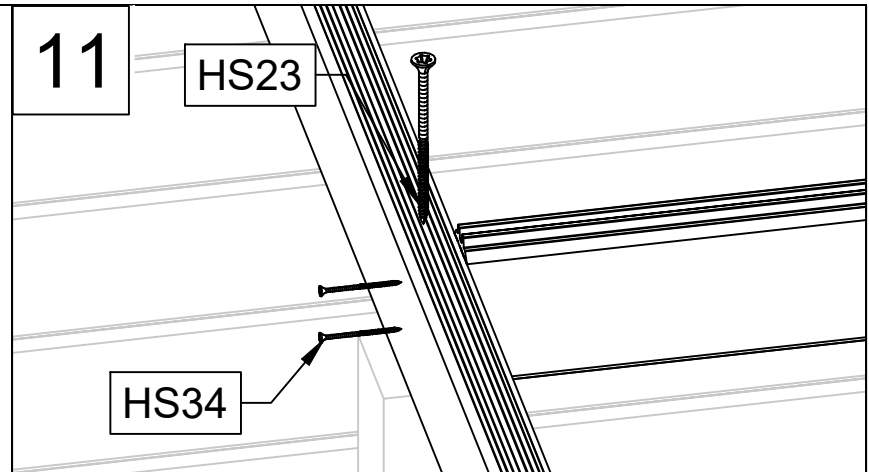
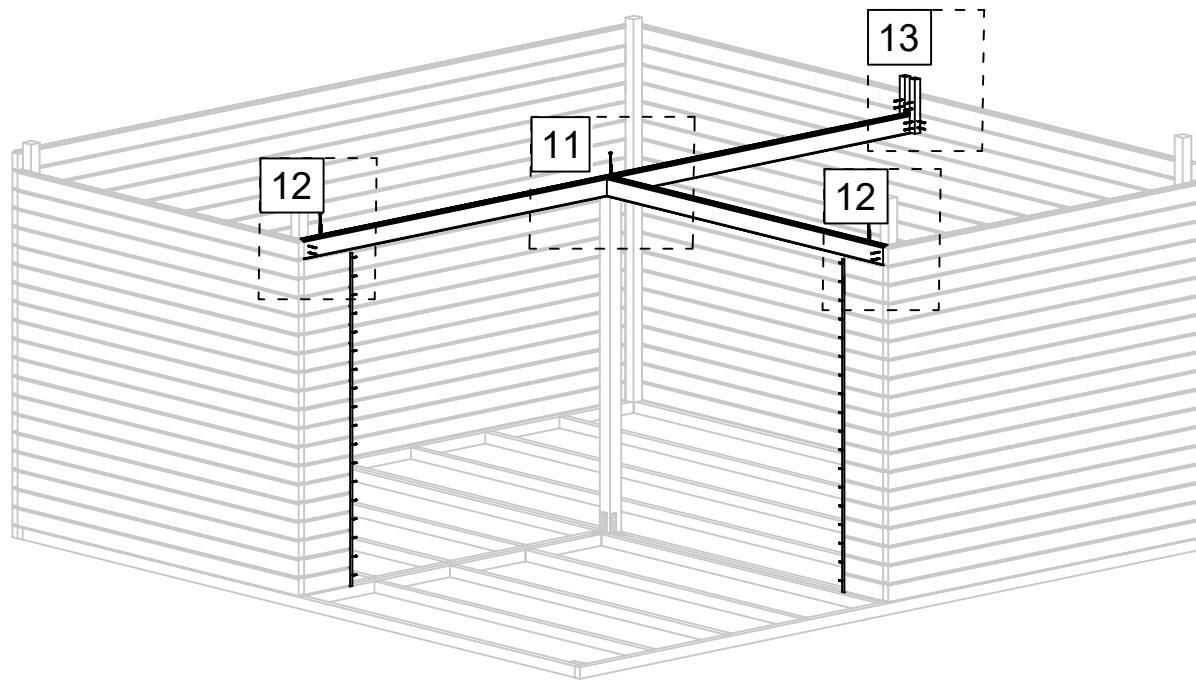



Art. Nr. 4426016

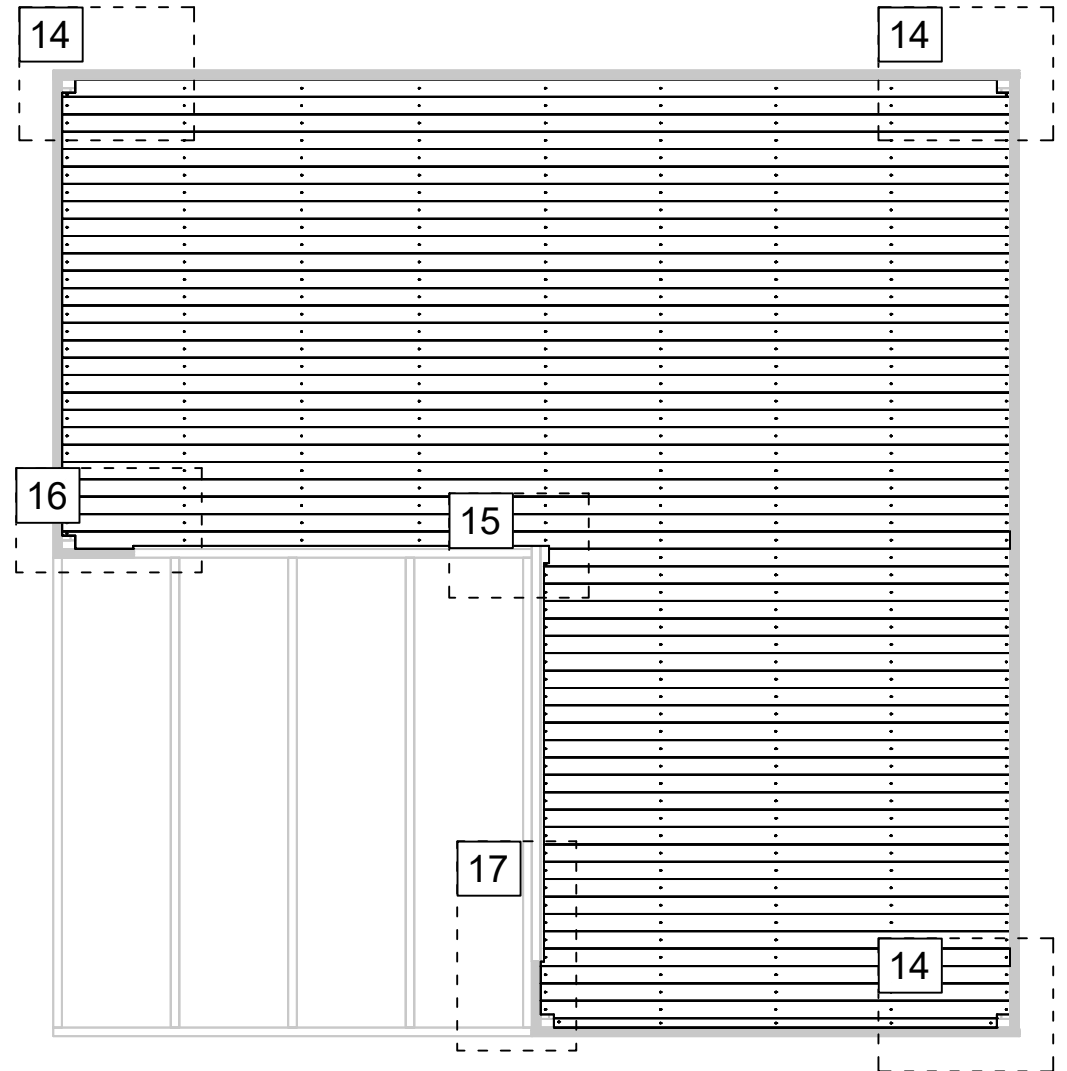
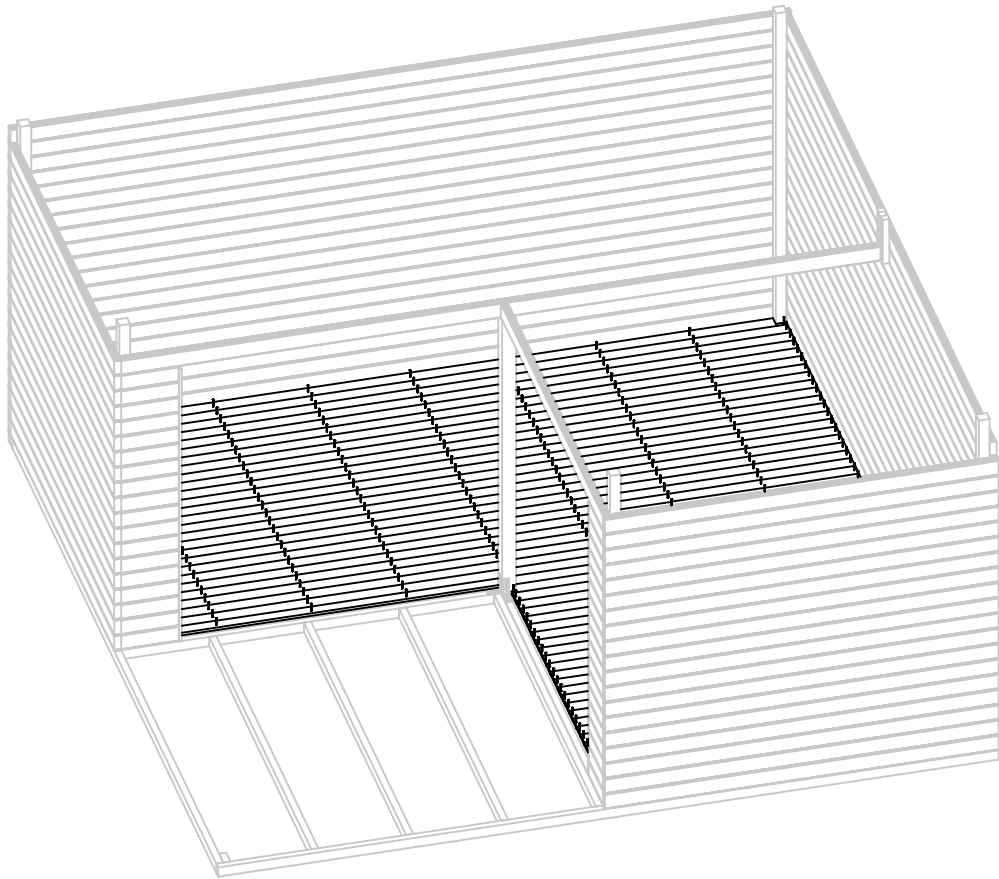

14

Art. Nr. 4426019

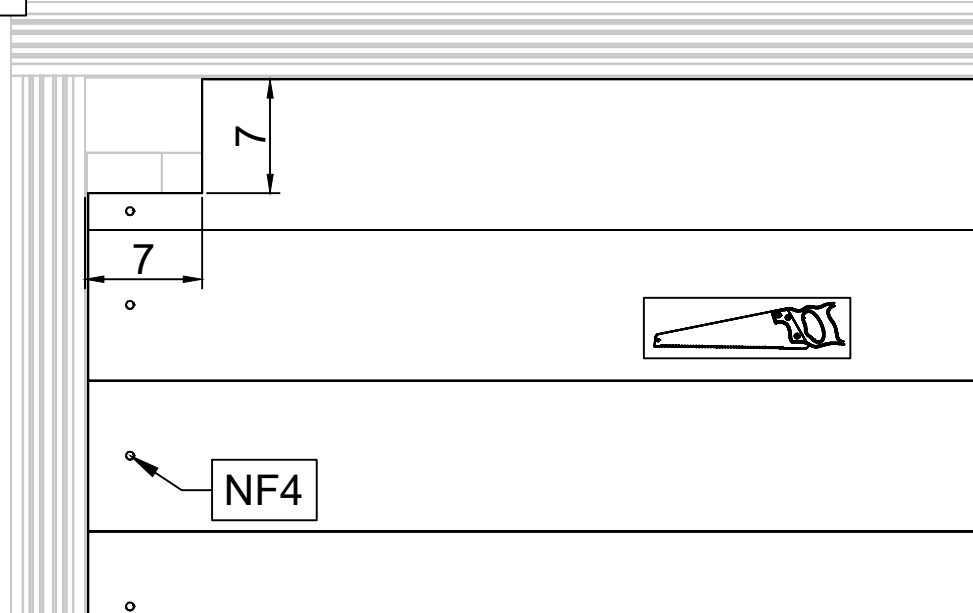

15

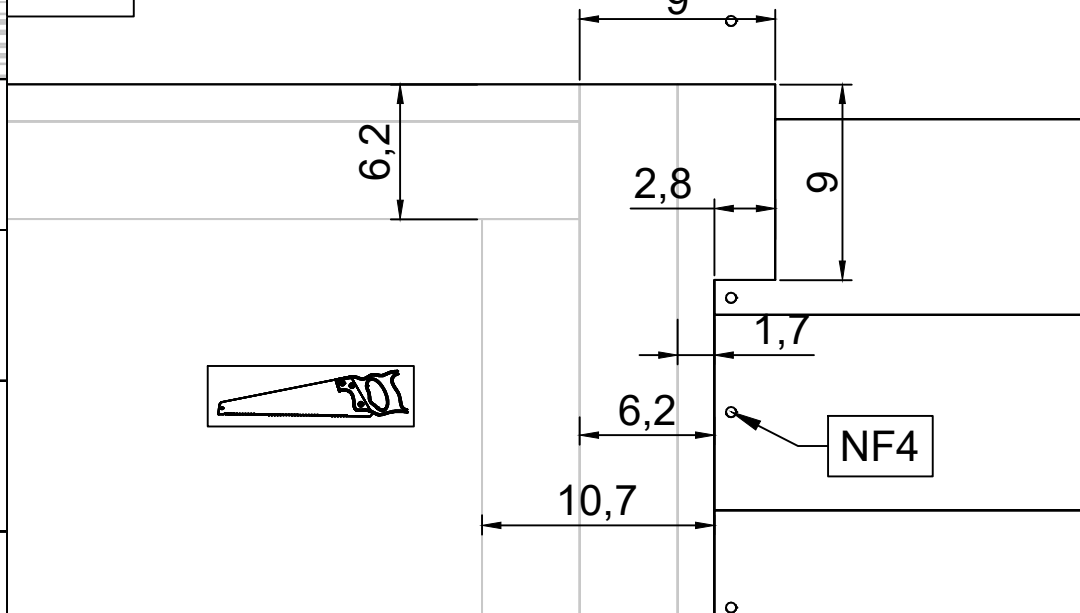

16

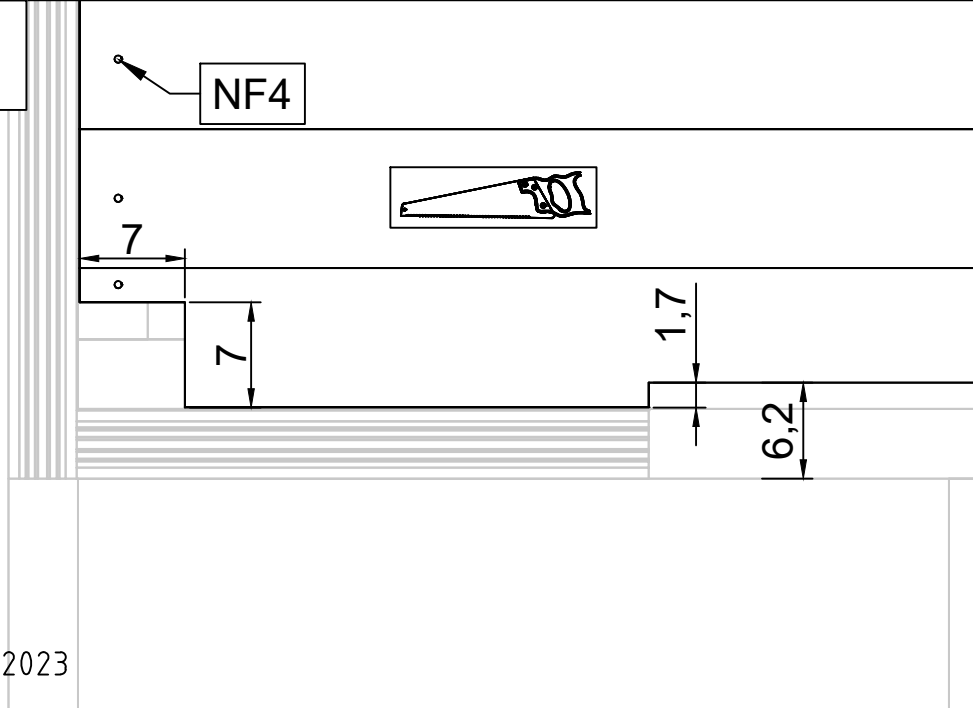

17

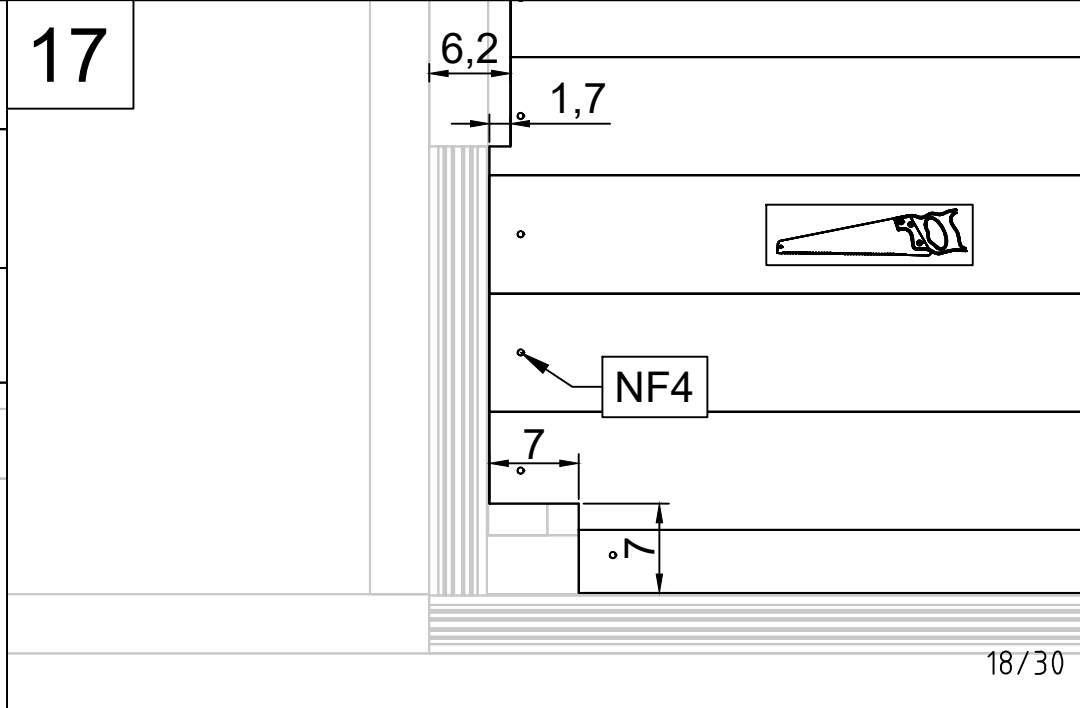

Art. Nr. 4426016

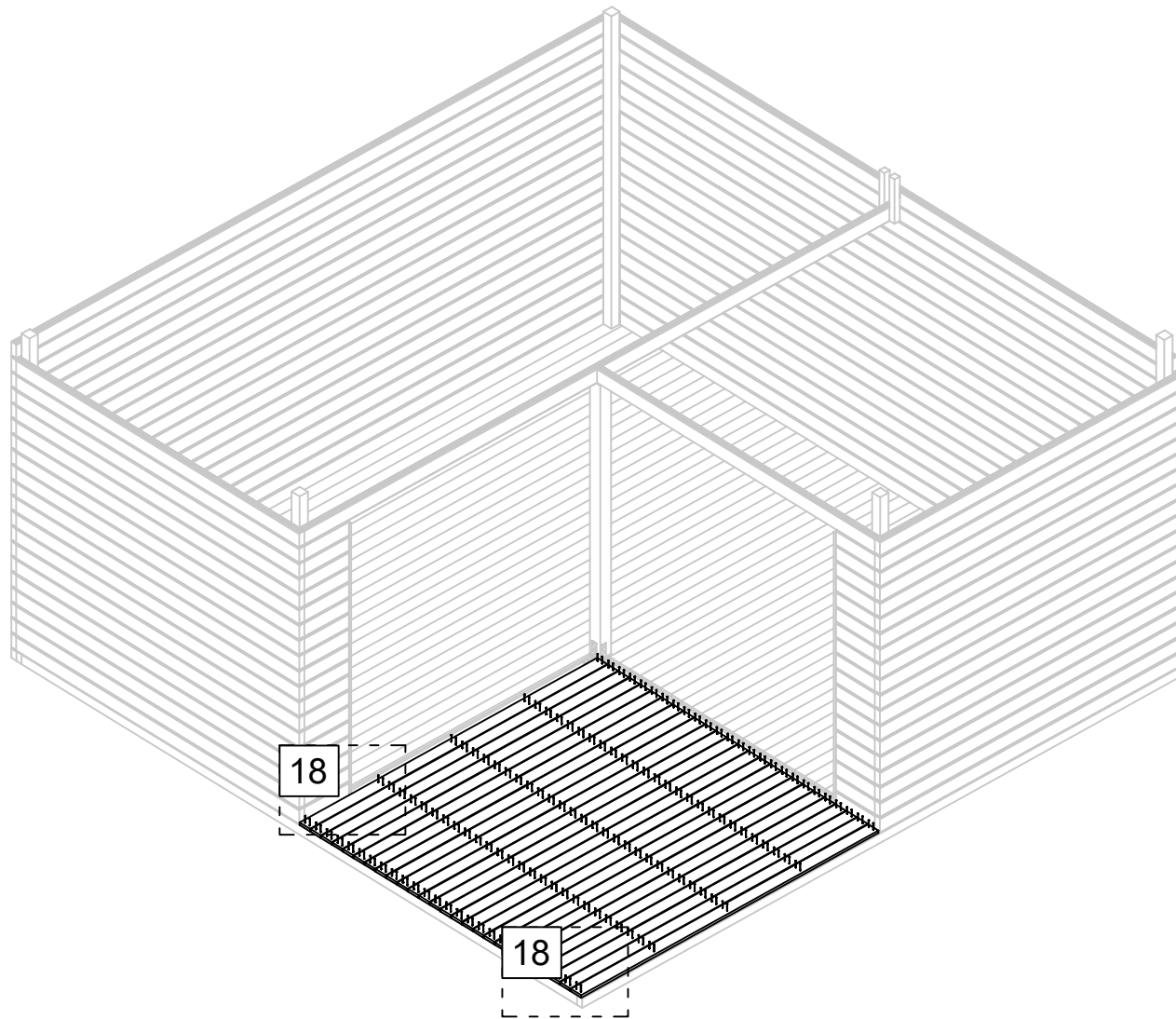

18

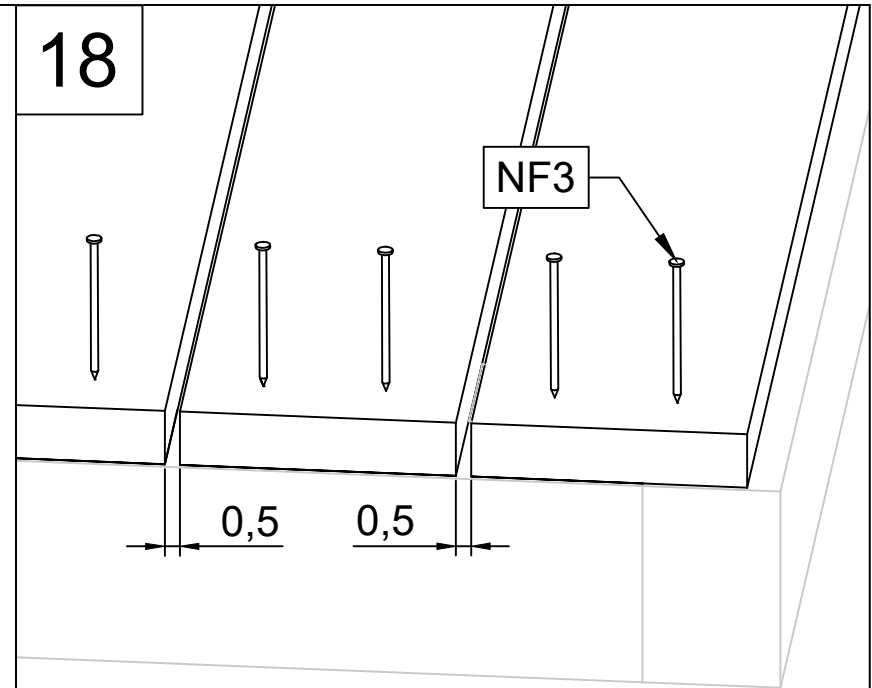

18

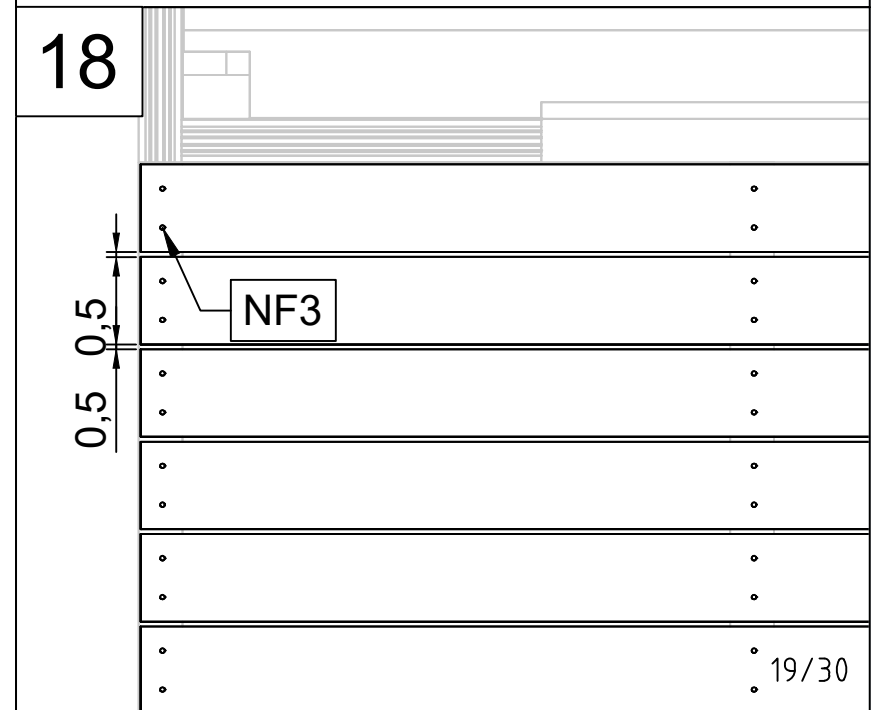

Art. Nr. 4426016

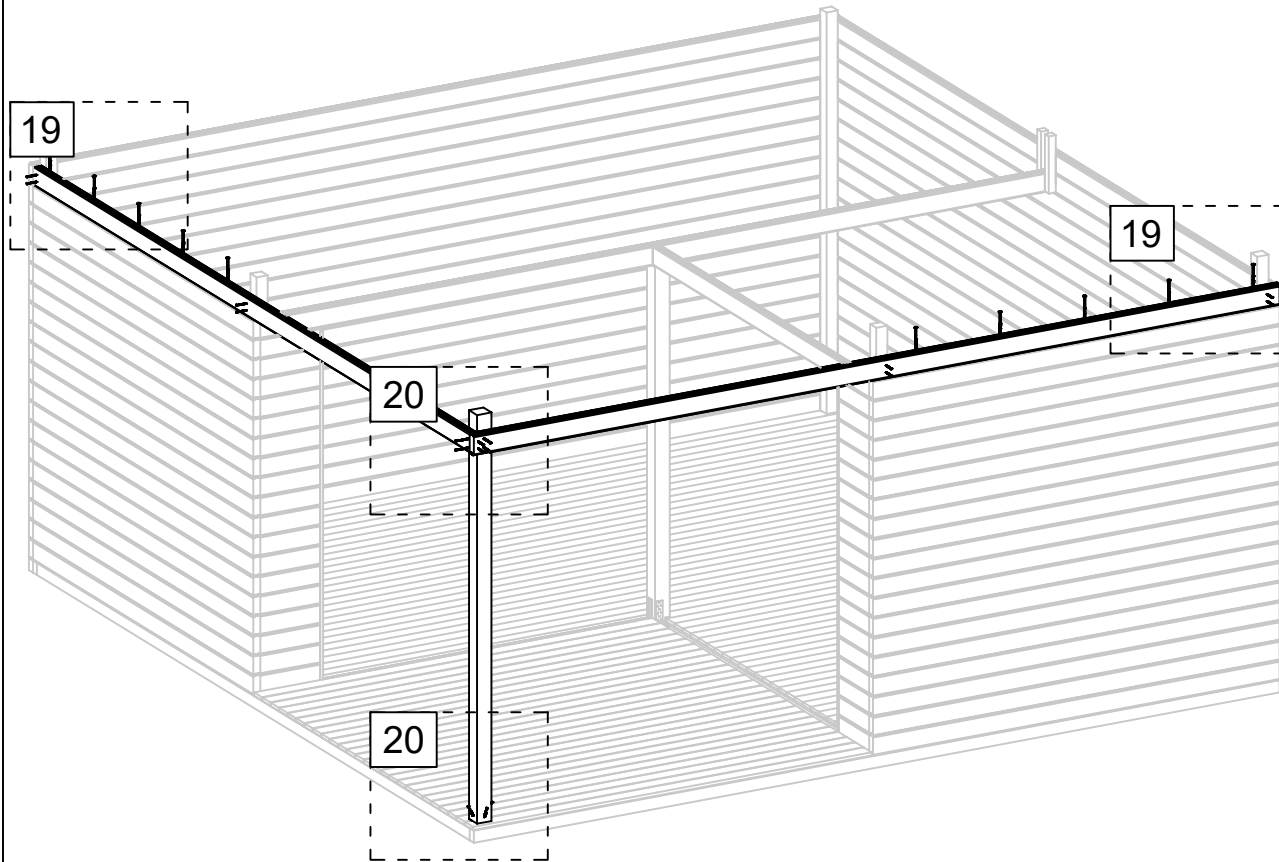

19

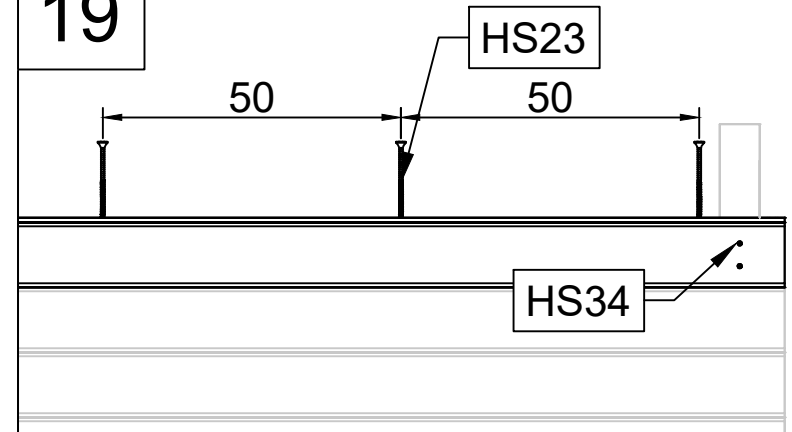

20

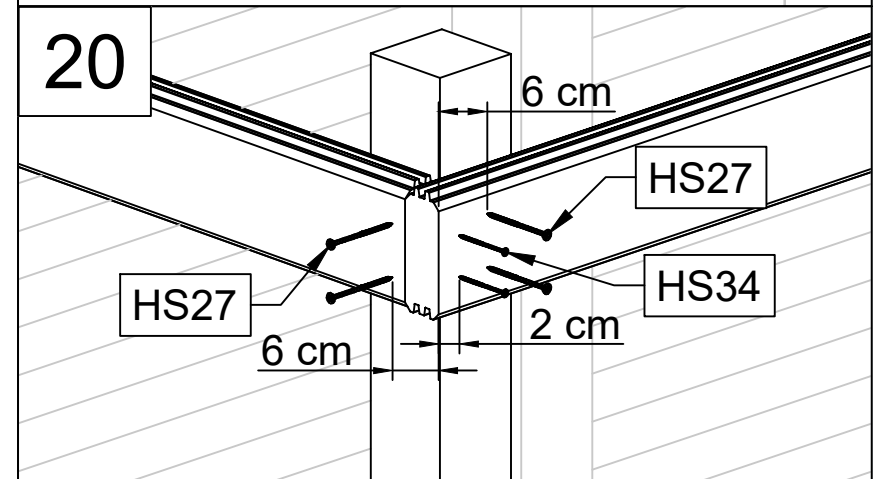

20

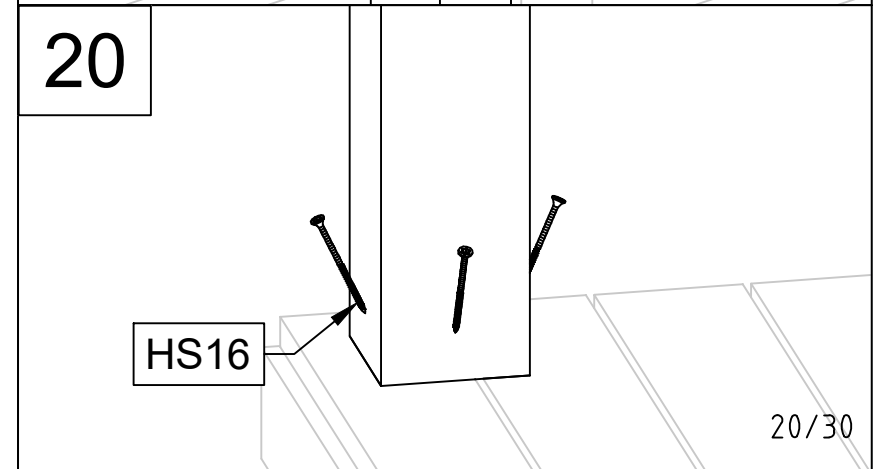

Art. Nr. 4426016

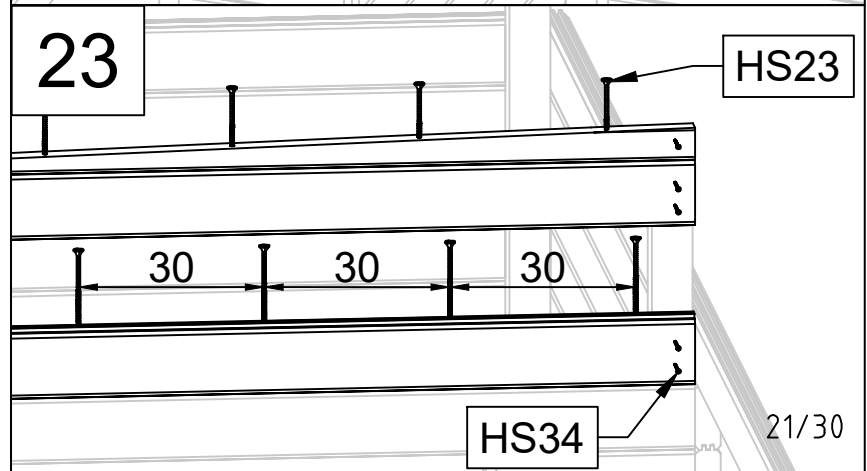
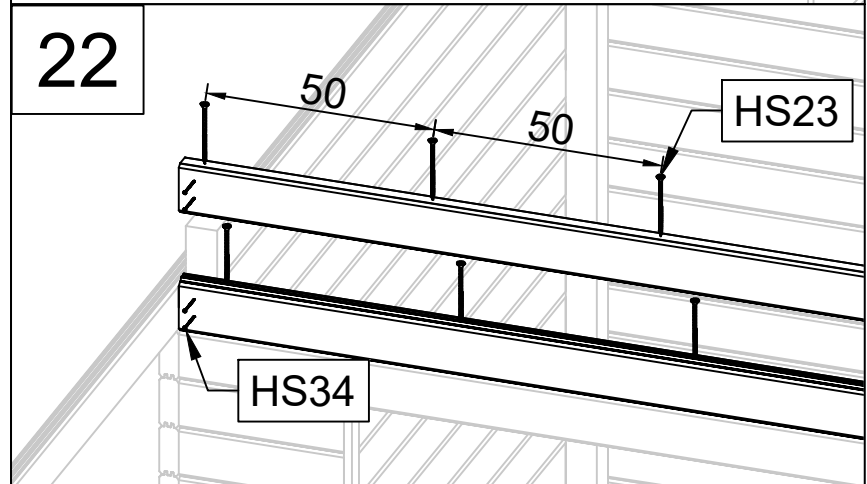
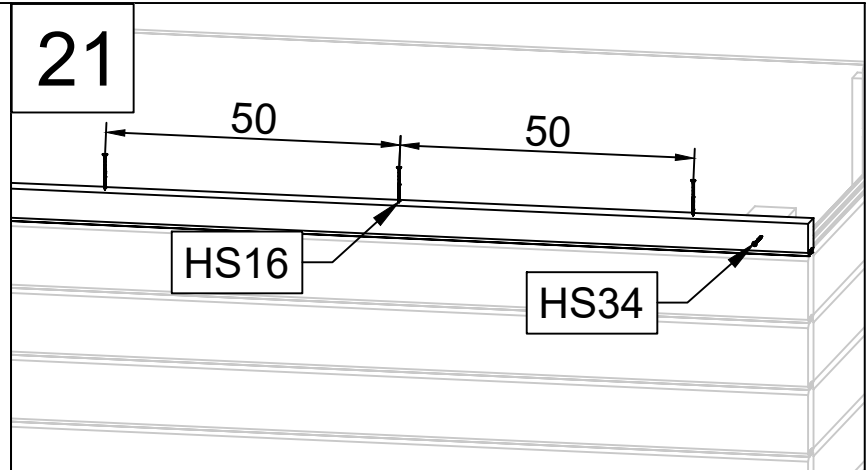
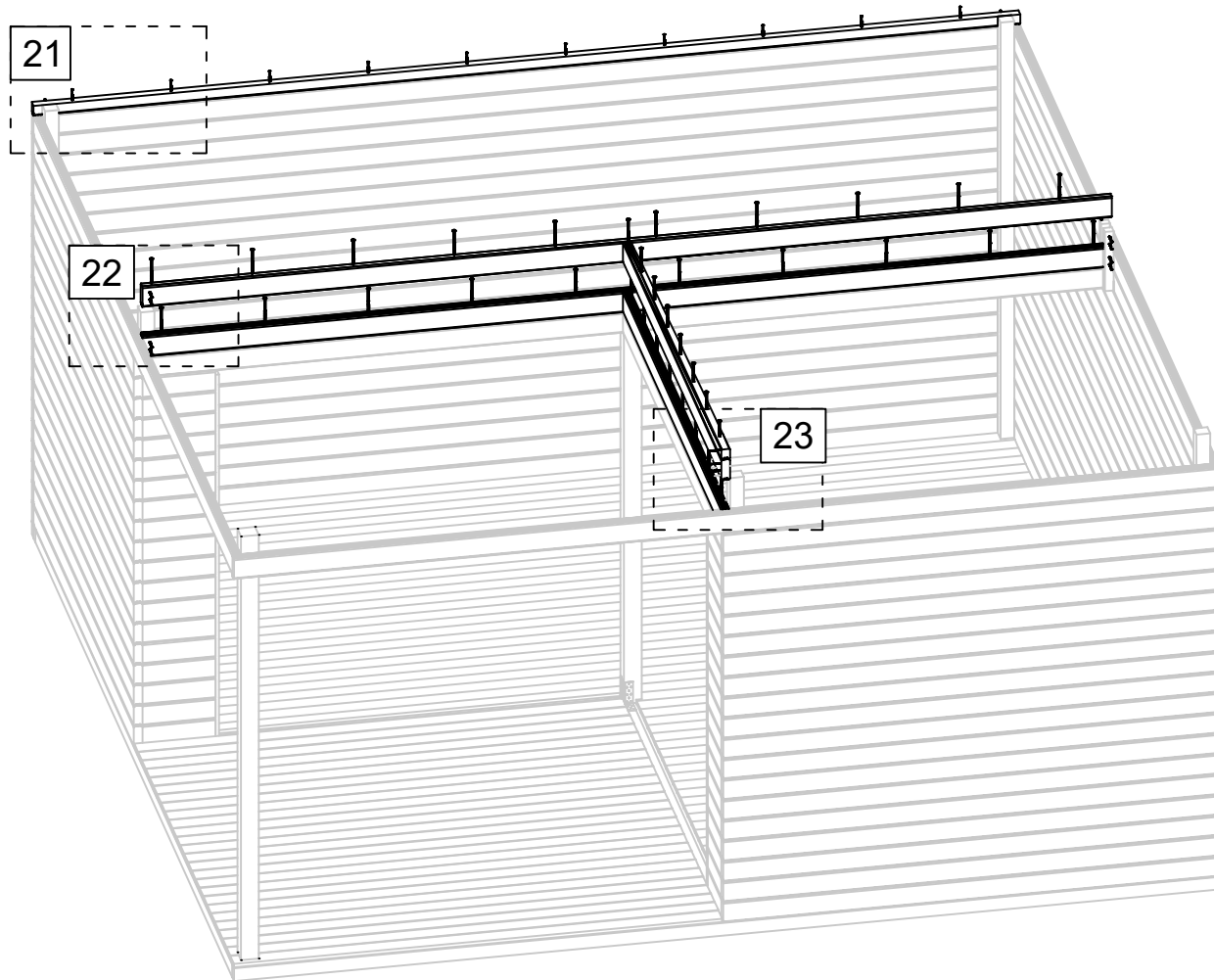

Art. Nr. 4426016

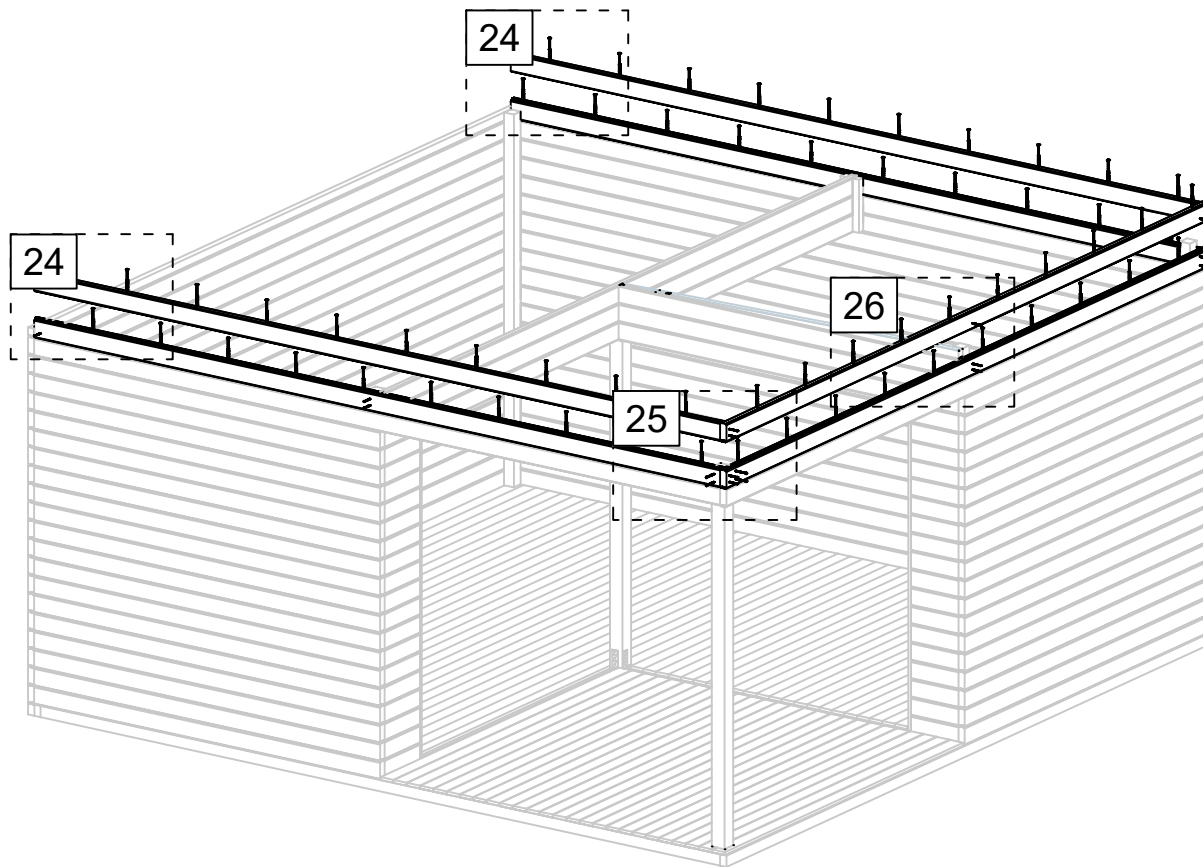

24

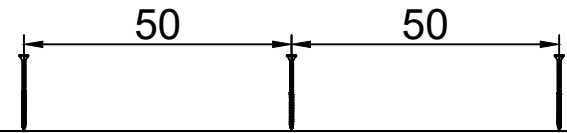

HS34

HS23

25

HS23

HS27

HS34

26

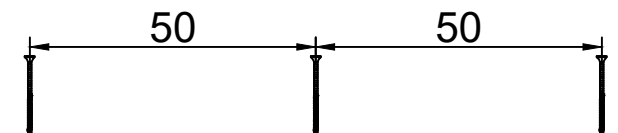

HS23

HS34

Art. Nr. 4426016

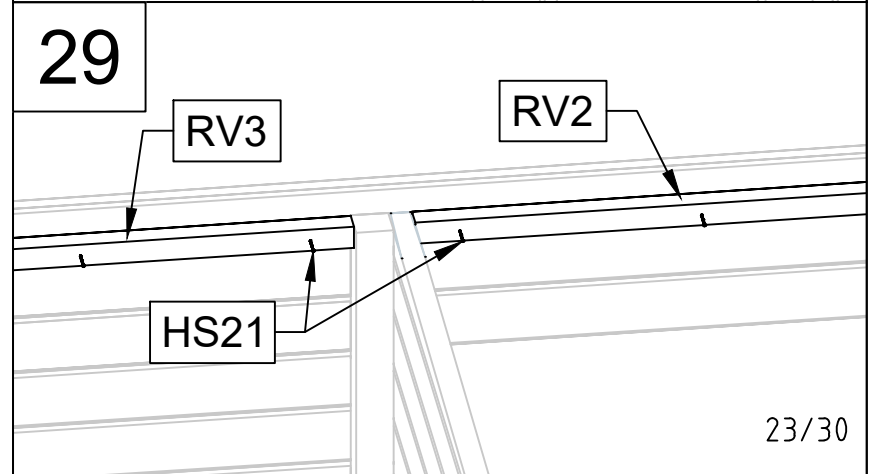
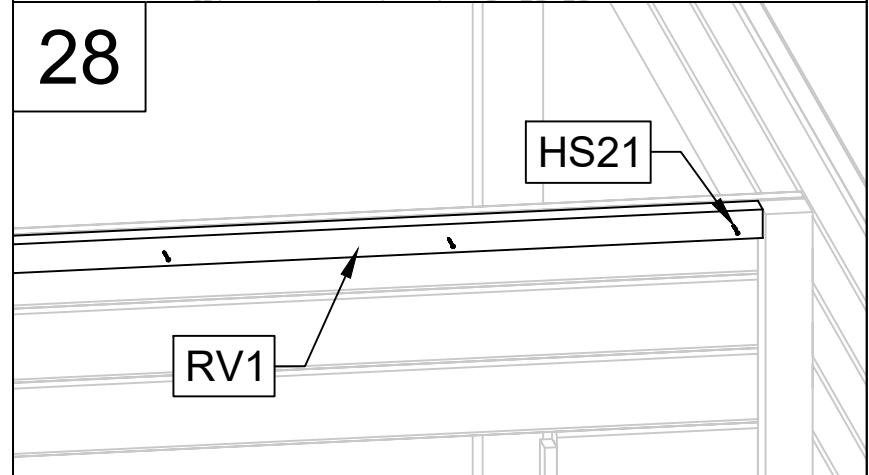
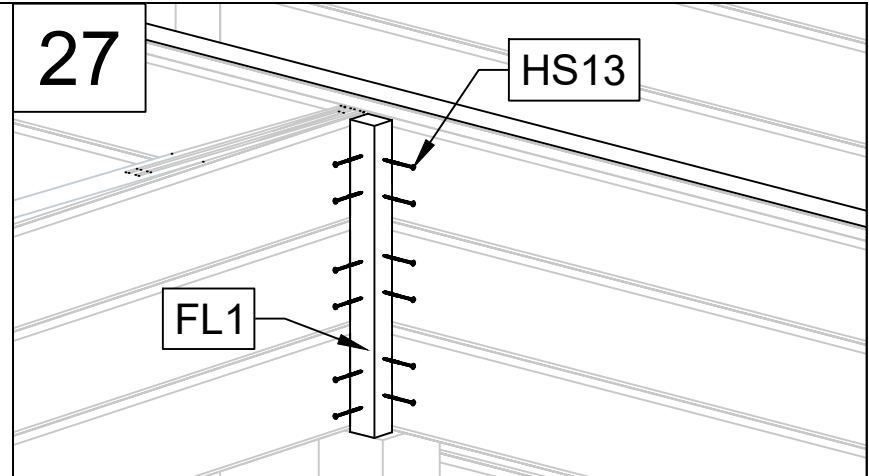
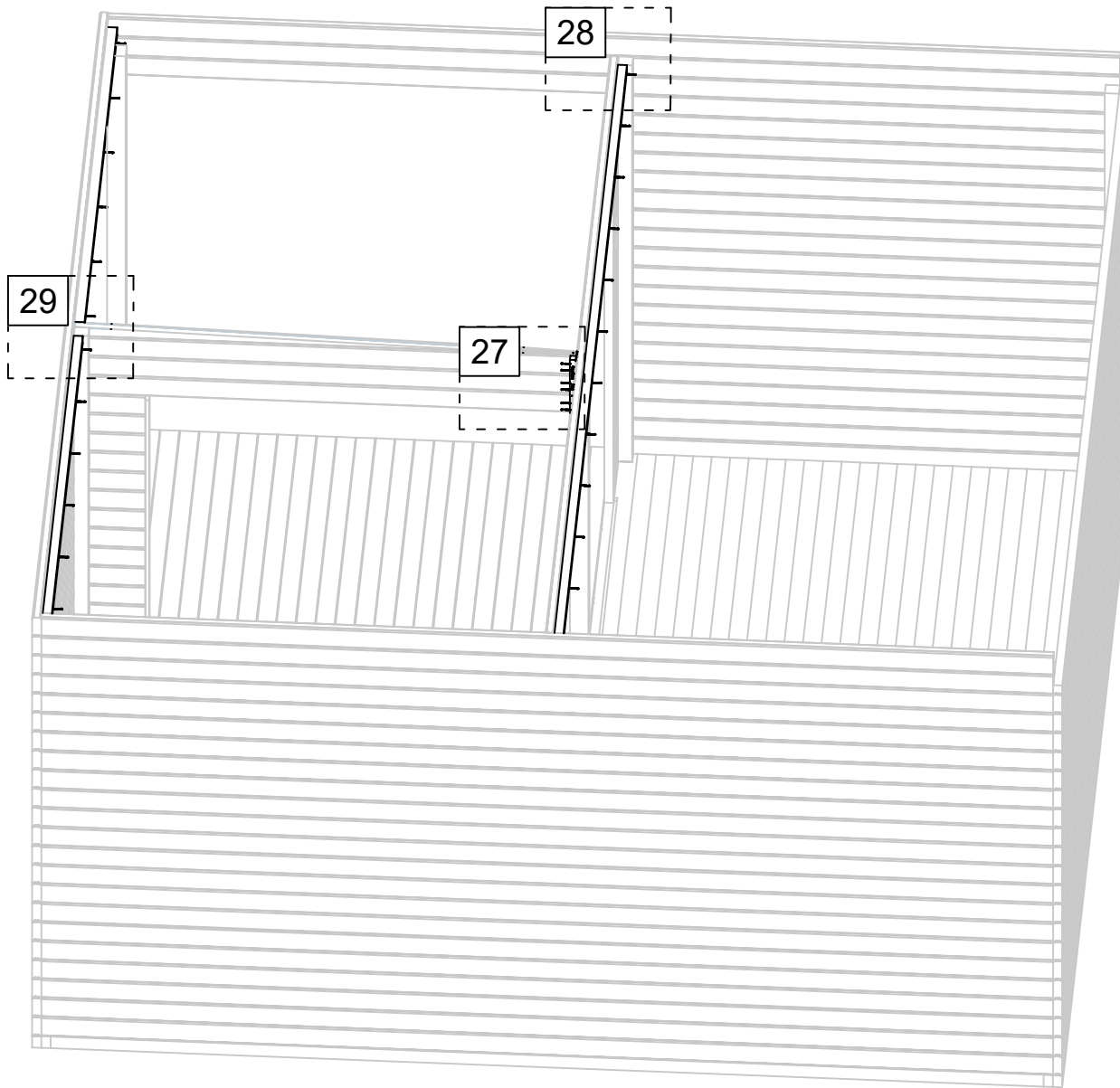

Art. Nr. 4426016

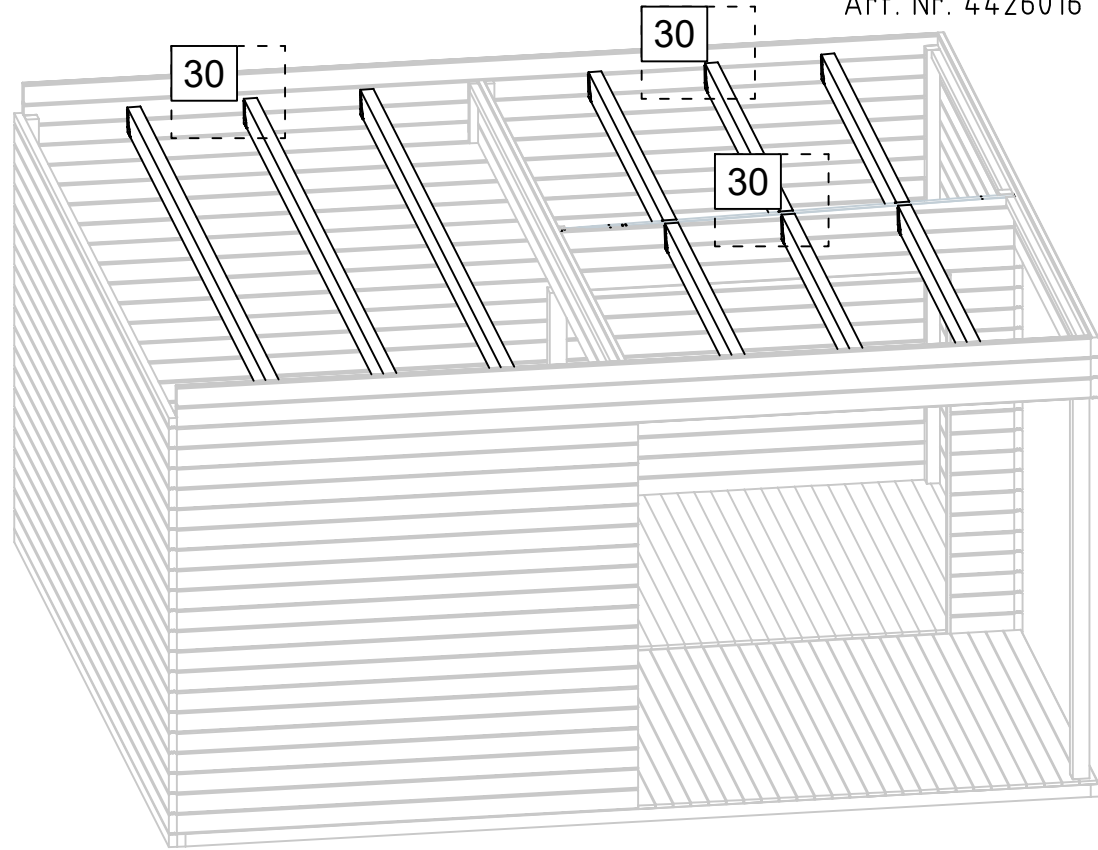

30

≈1,5cm

BM

HS12

HS12

BM

HS12

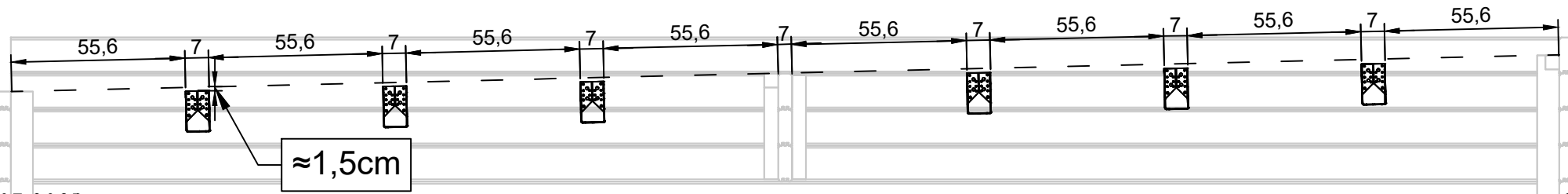
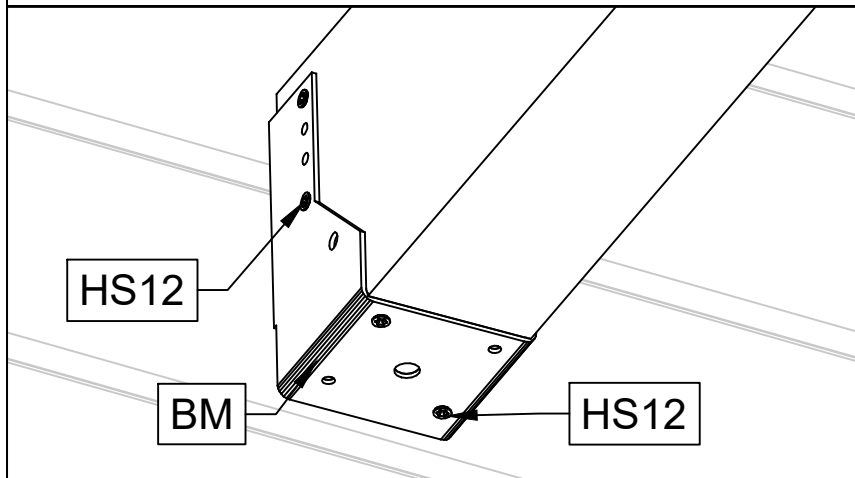
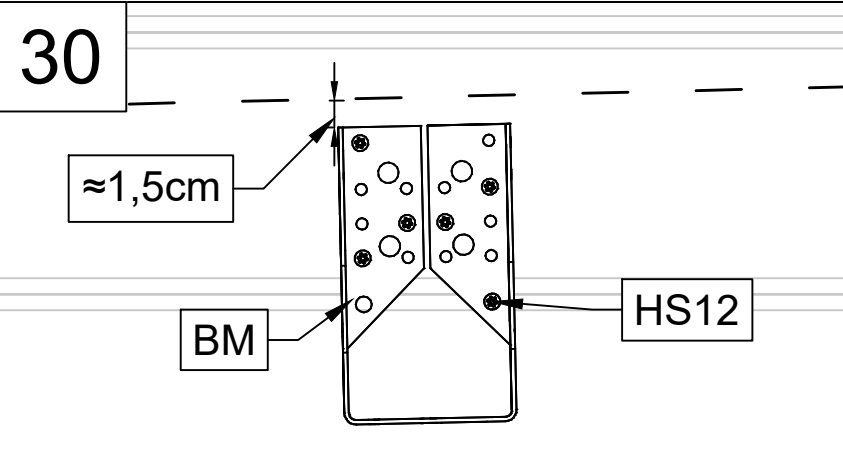



Art. Nr. 4426016

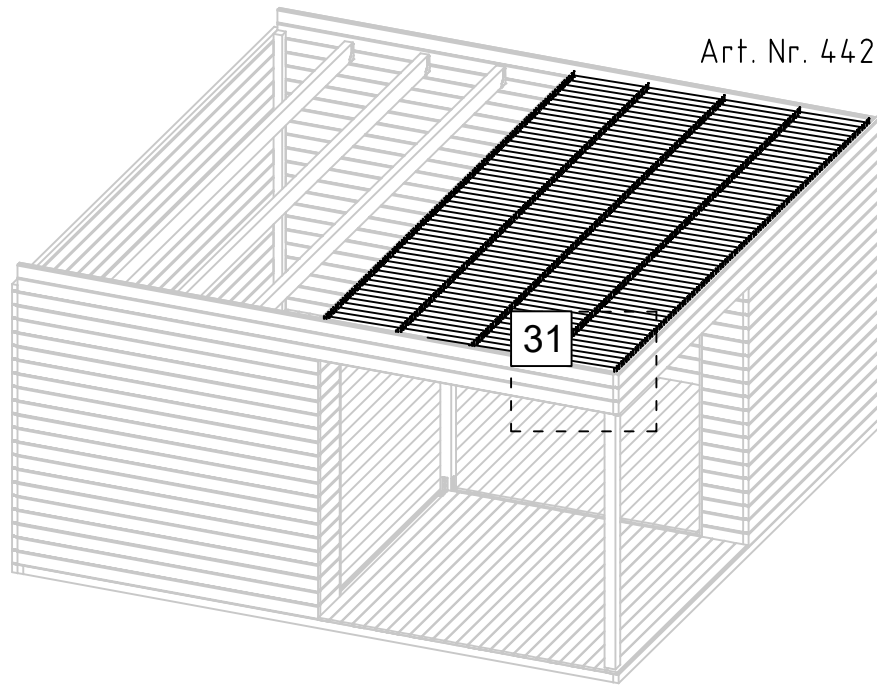

31

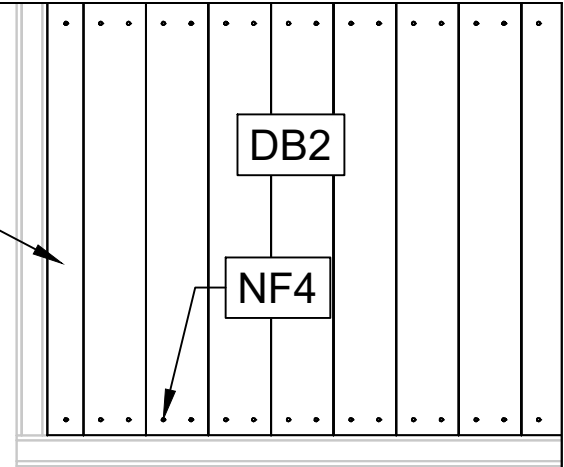
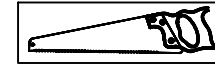

32

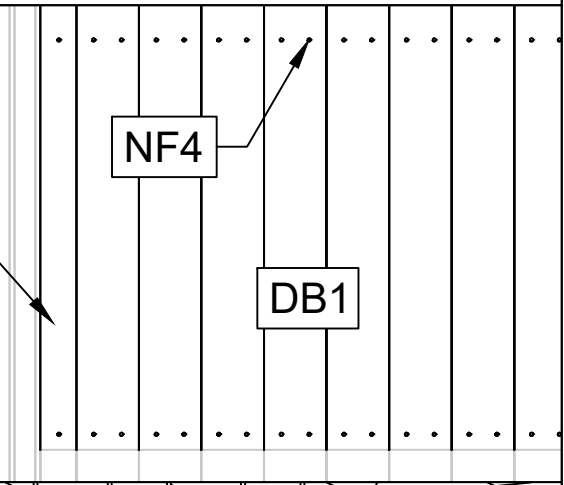
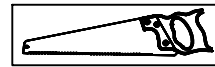

33

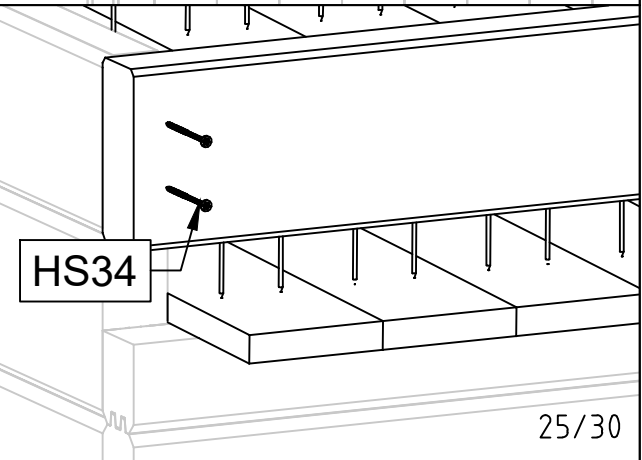
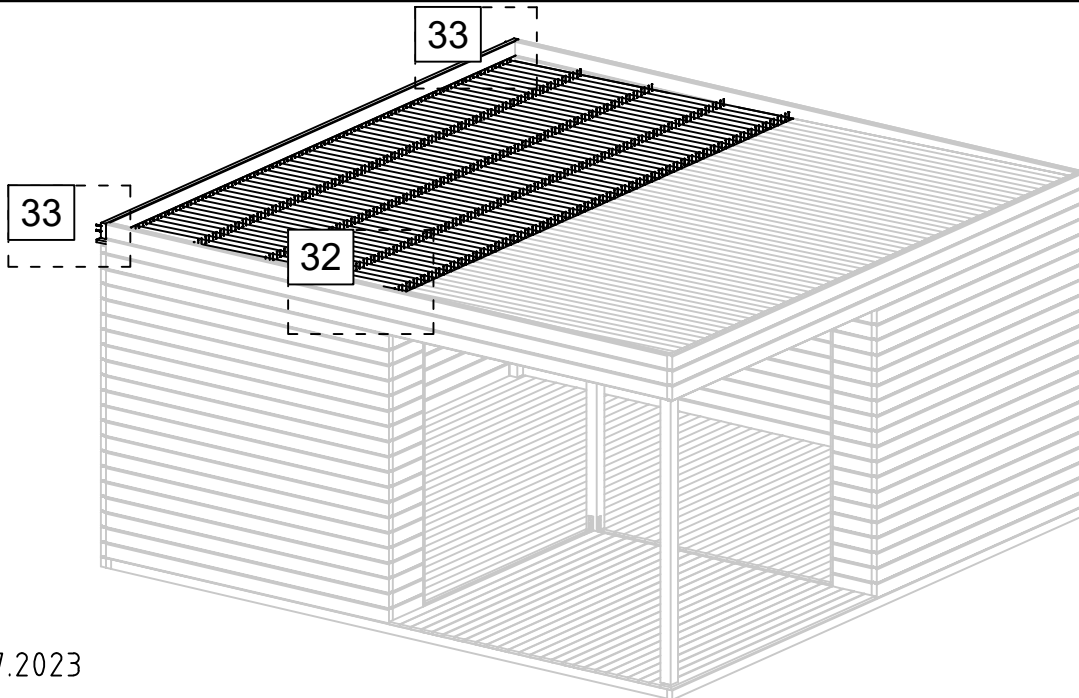

Art. Nr. 4426016

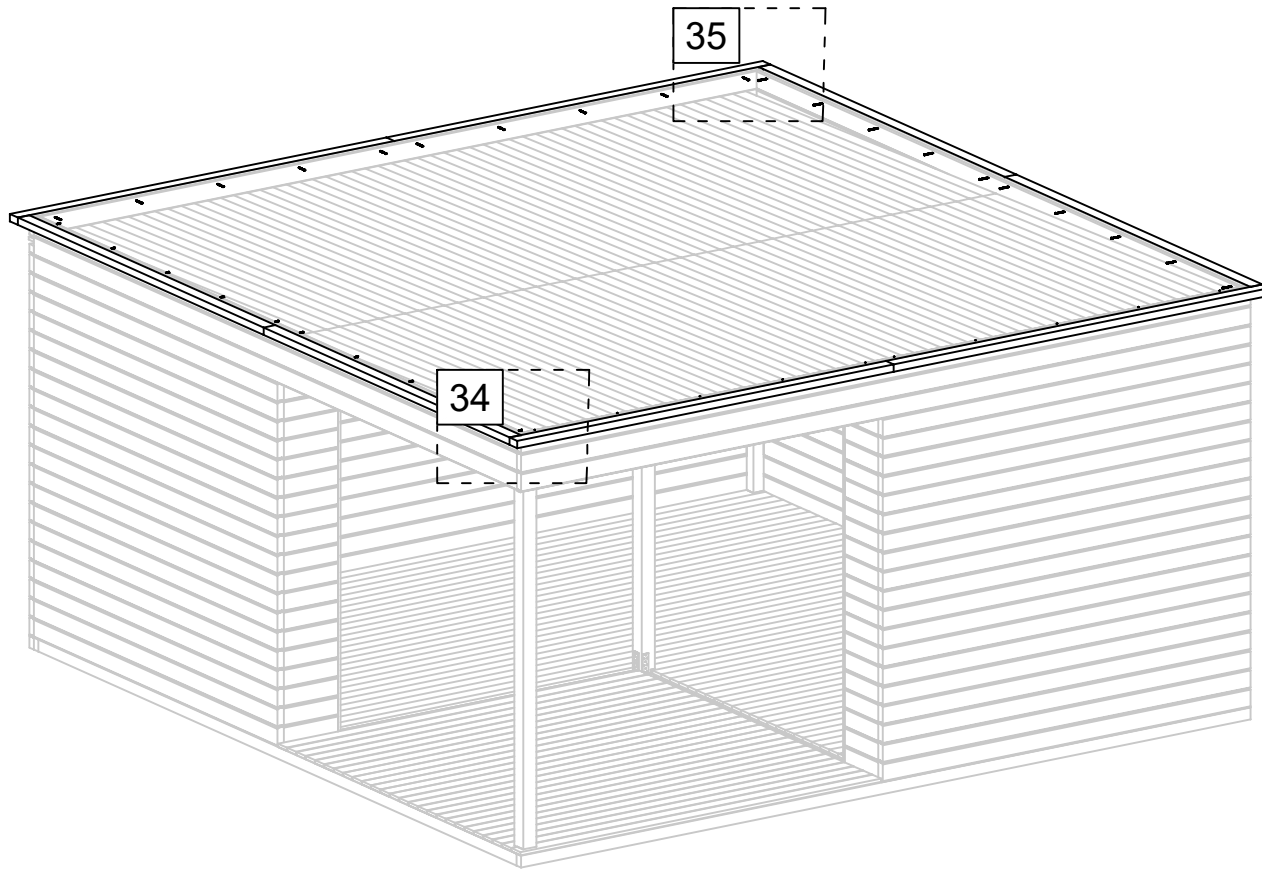

34

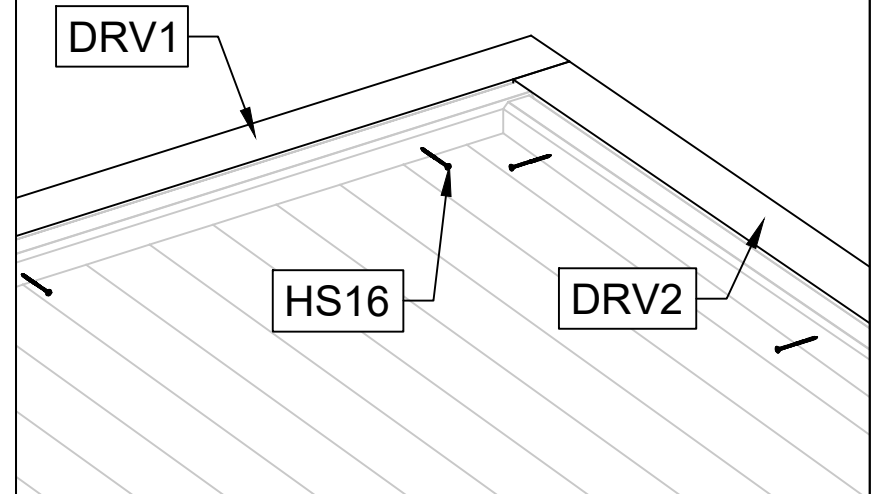

35

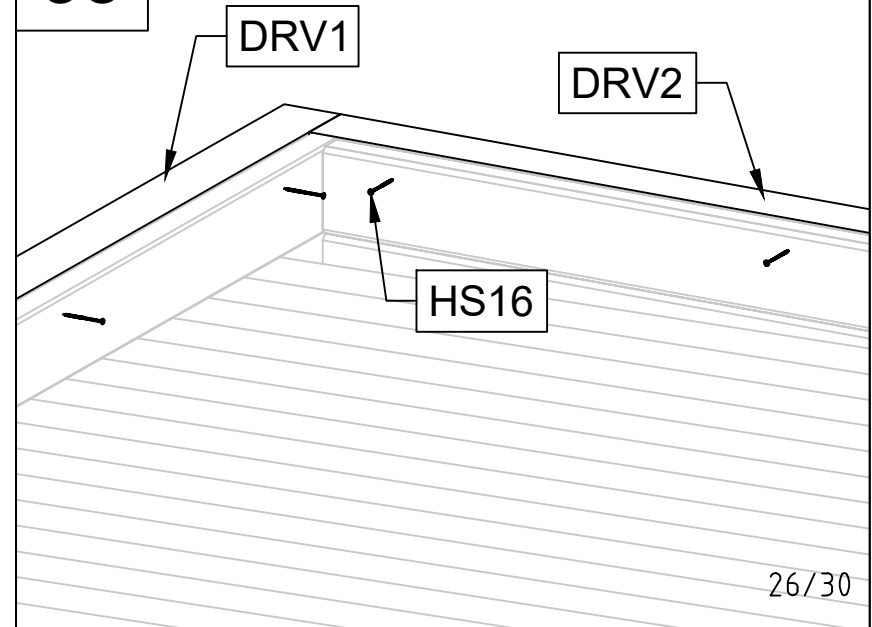

Art. Nr. 4426016

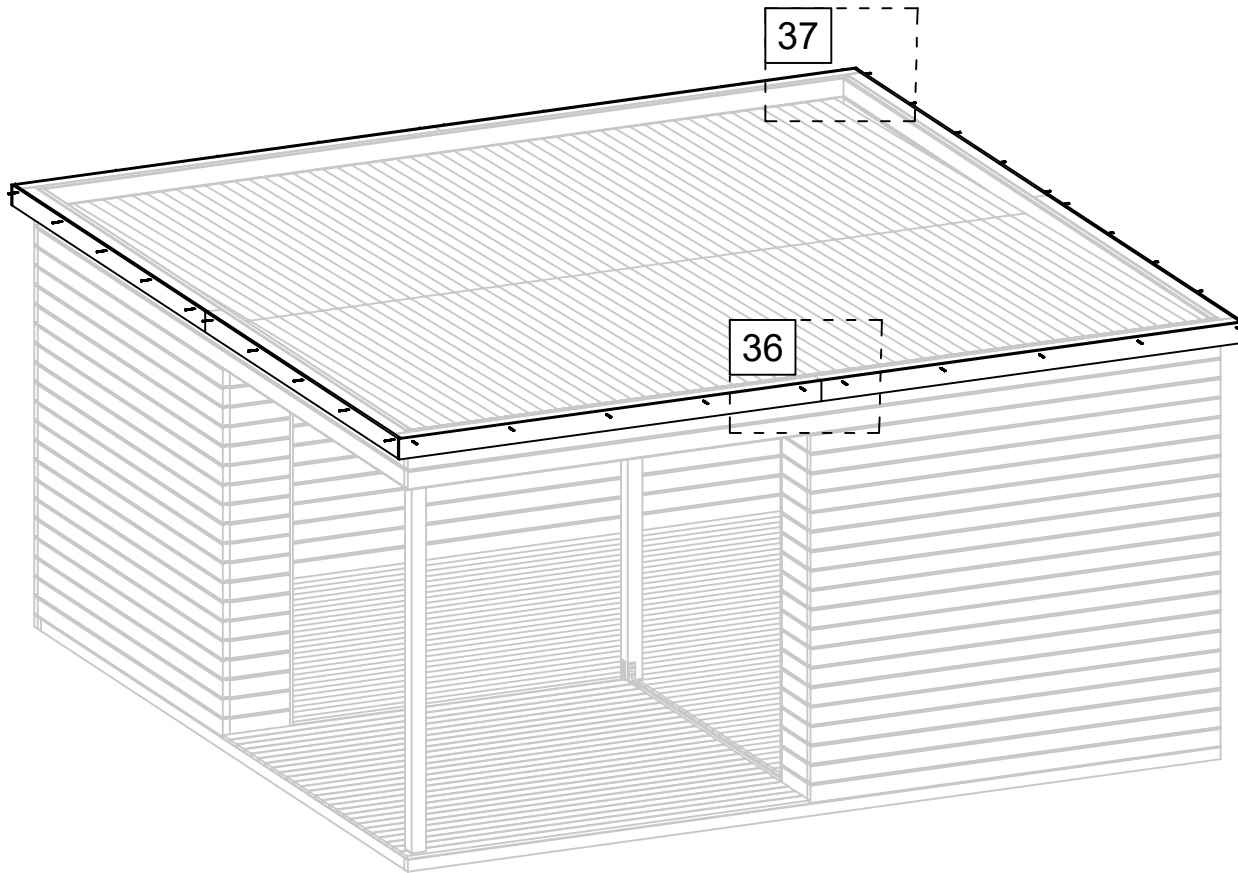

36

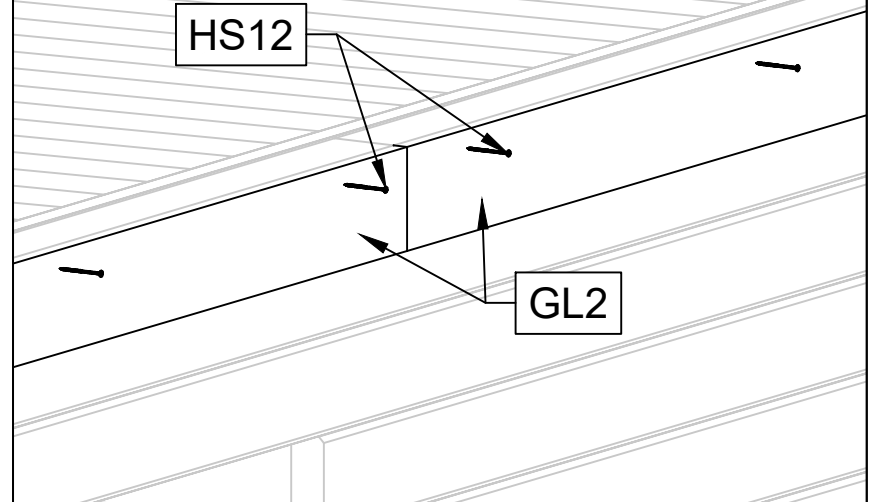

37

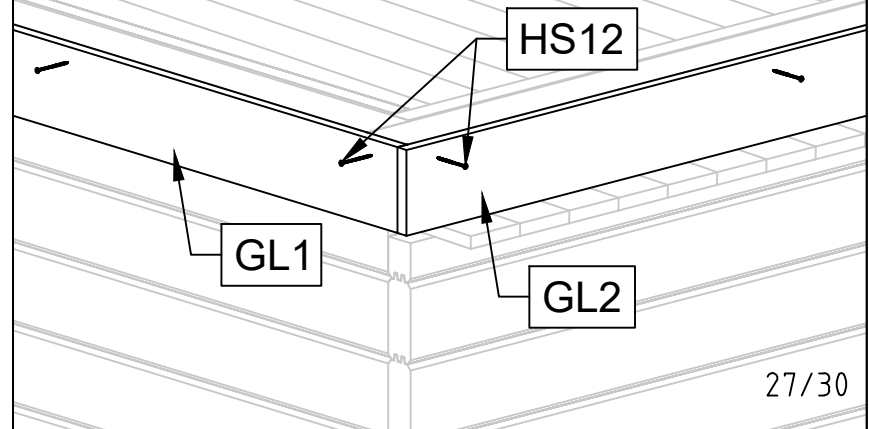

Art. Nr. 4426016

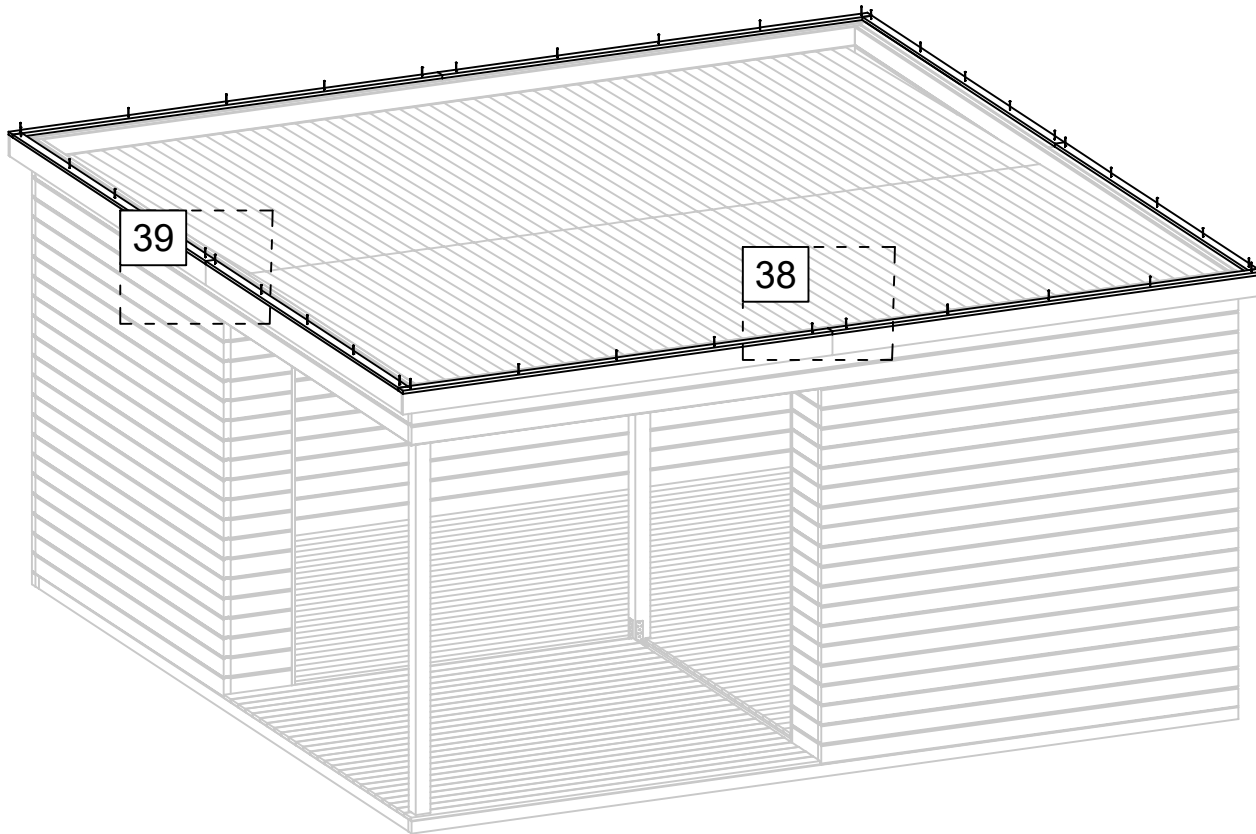

38

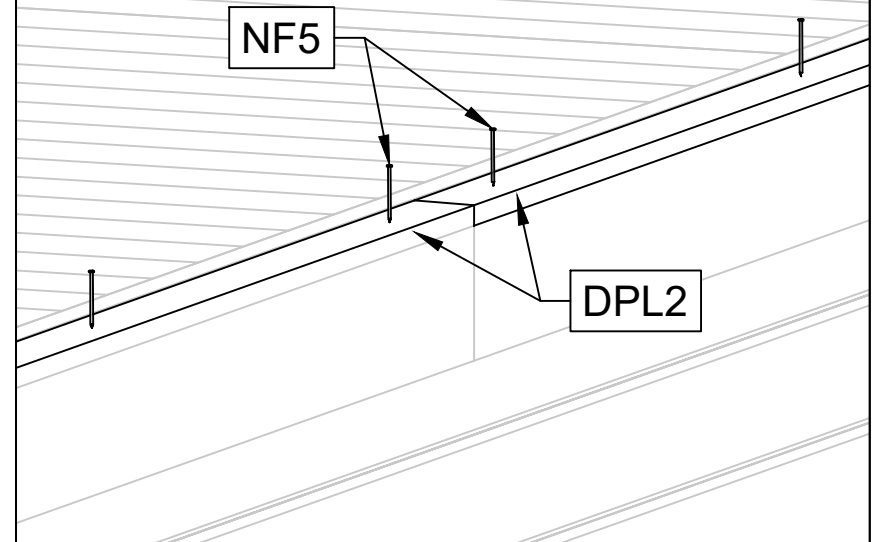

39

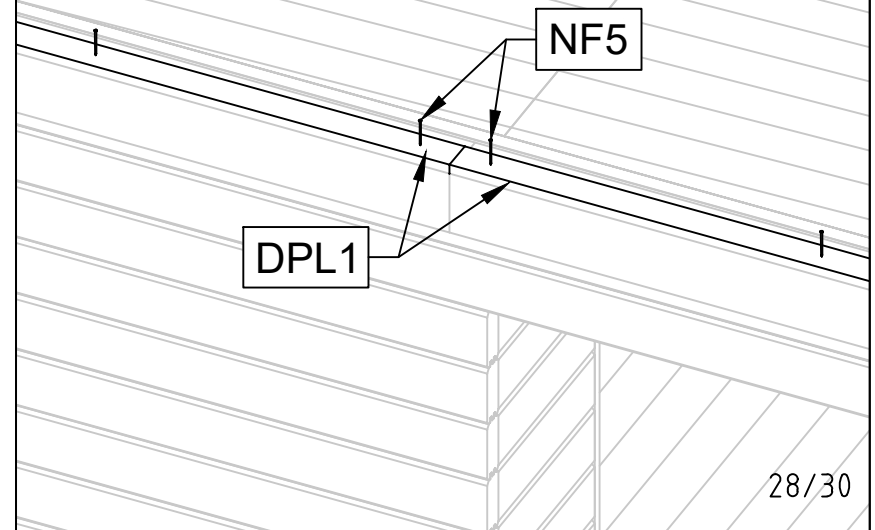

Art. Nr. 4426016

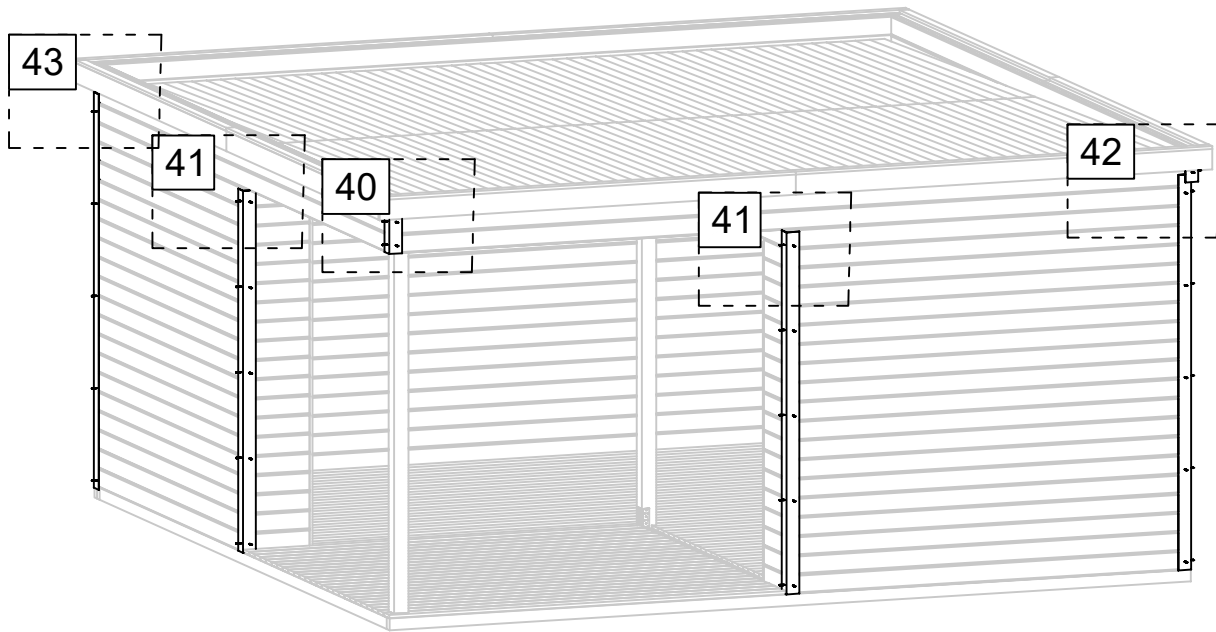

42

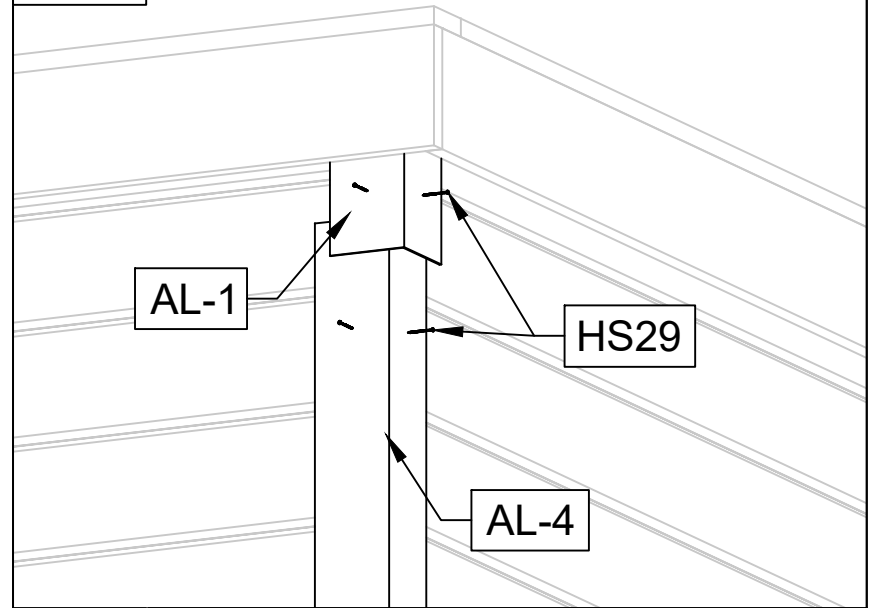

43

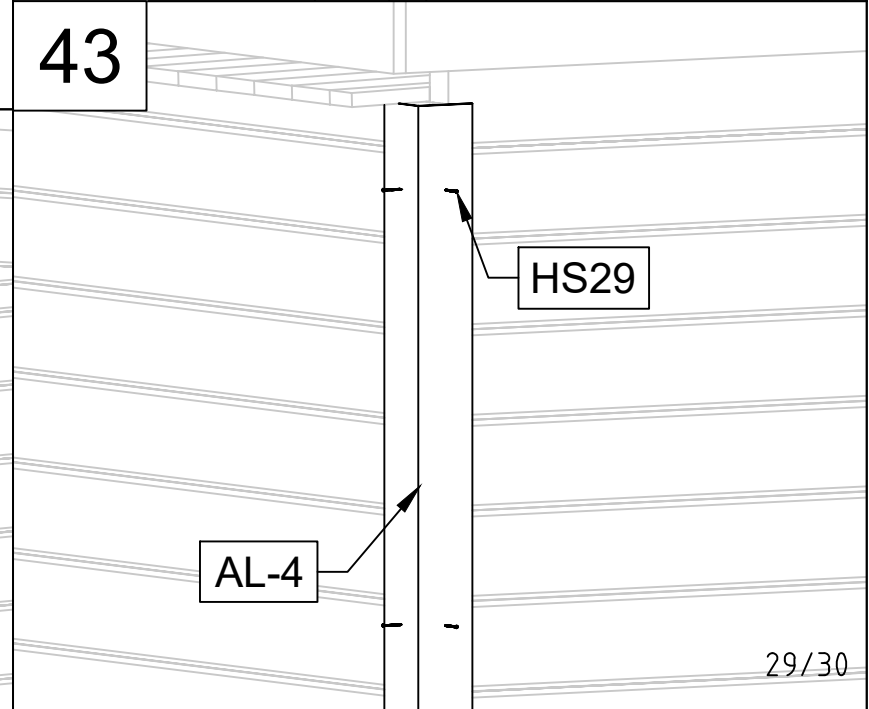

40

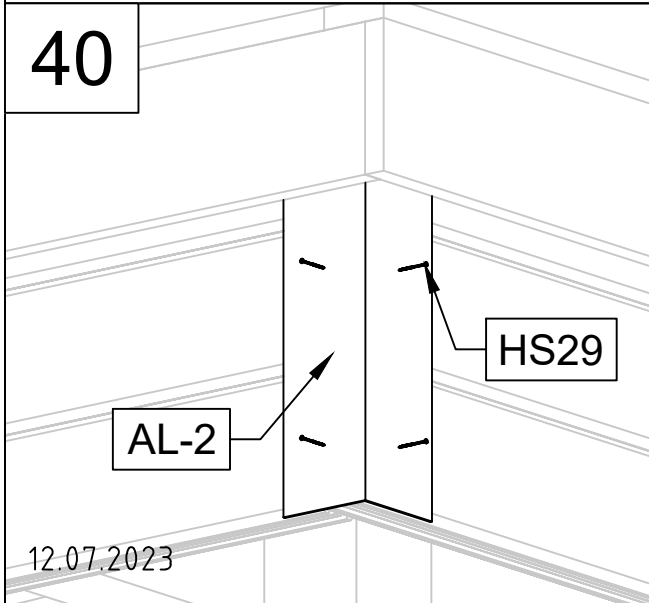

41

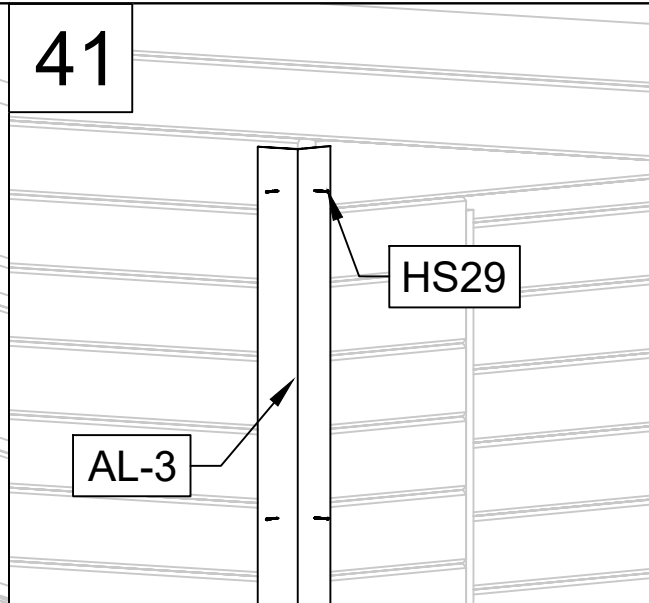

Art. Nr. 4426016

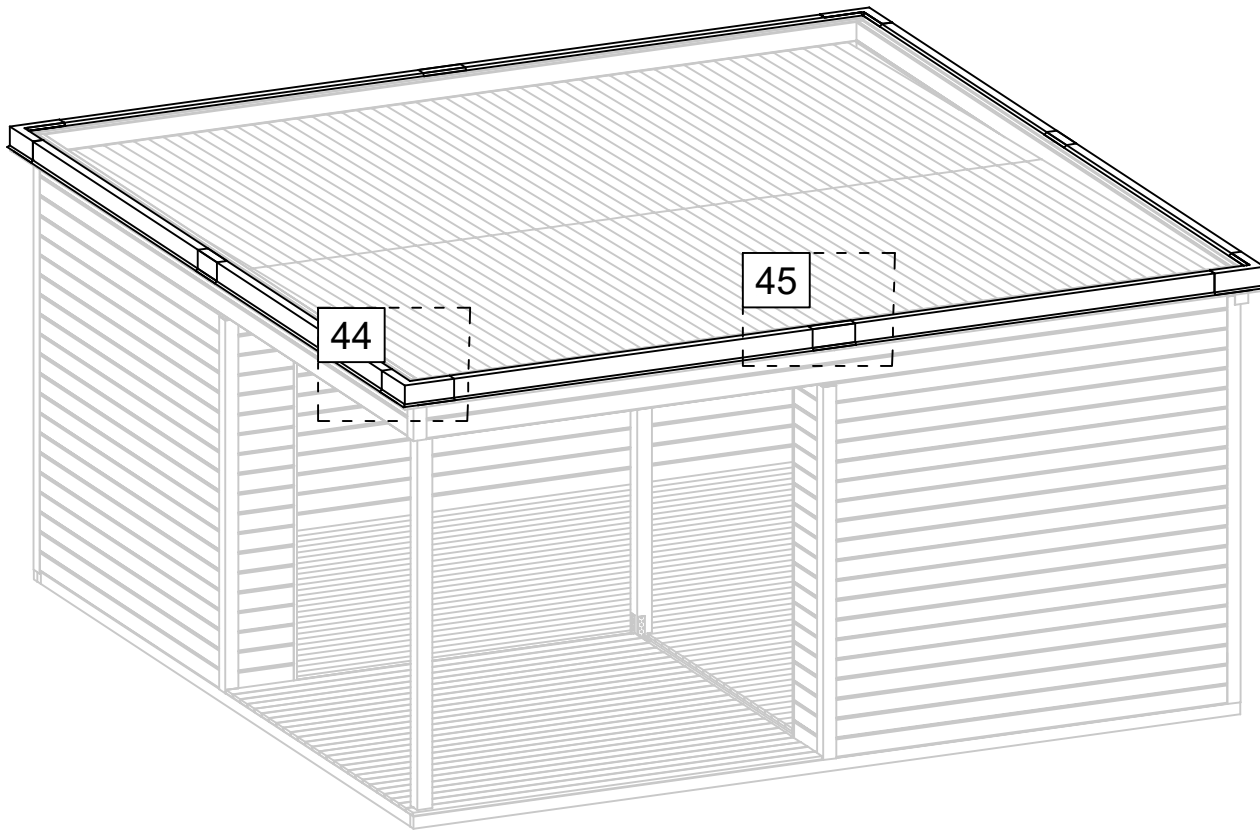

44

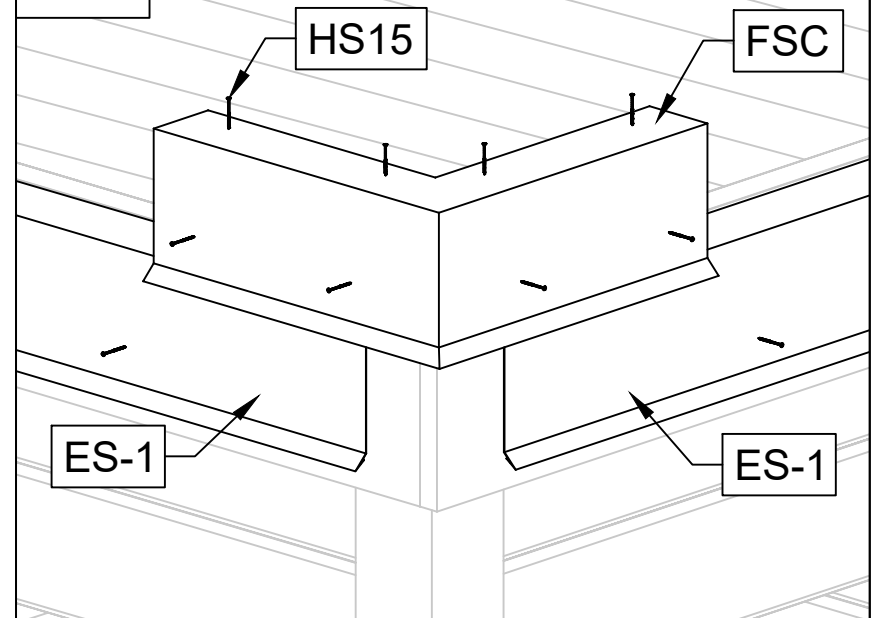

45

