

Art. Nr. 2854594  
1/6

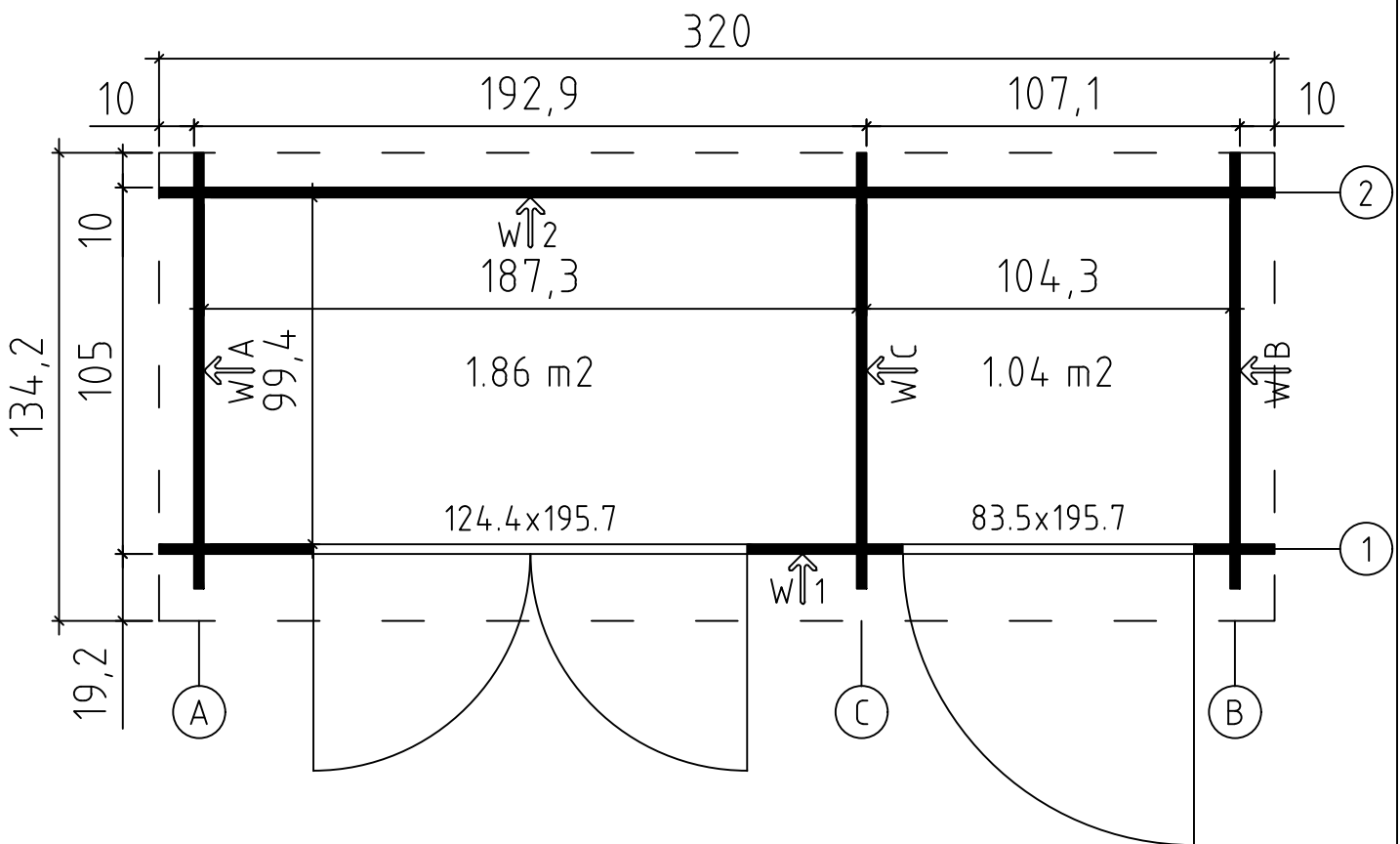

10.01.2023

Groundplan - Grundplan - Plan de masse -  
Planimetria - Plattegrond - Põhiplaan



Art. Nr. 2854594

Without tongue - Ohne feder - Madrier de finition -  
Finale in legno - Zonder veer - Punnita

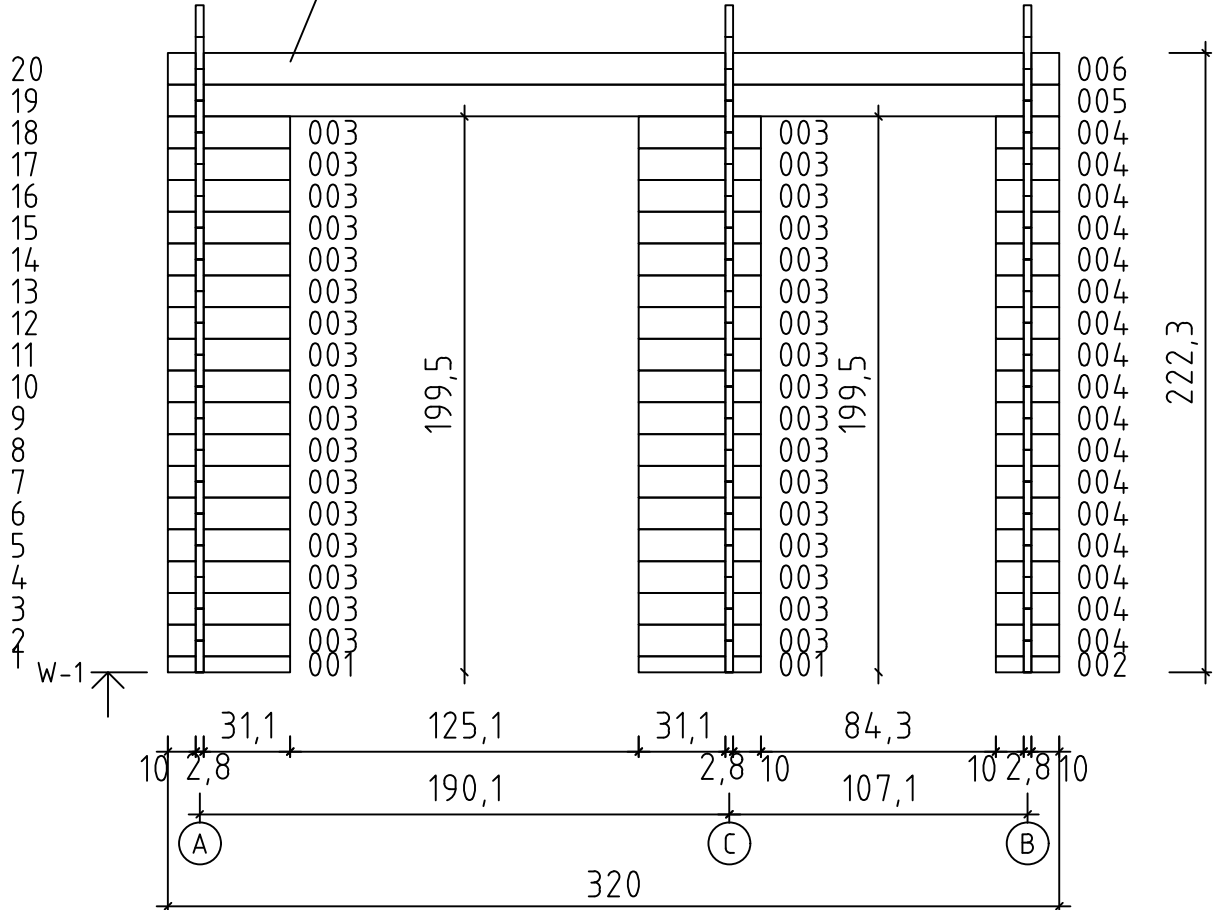



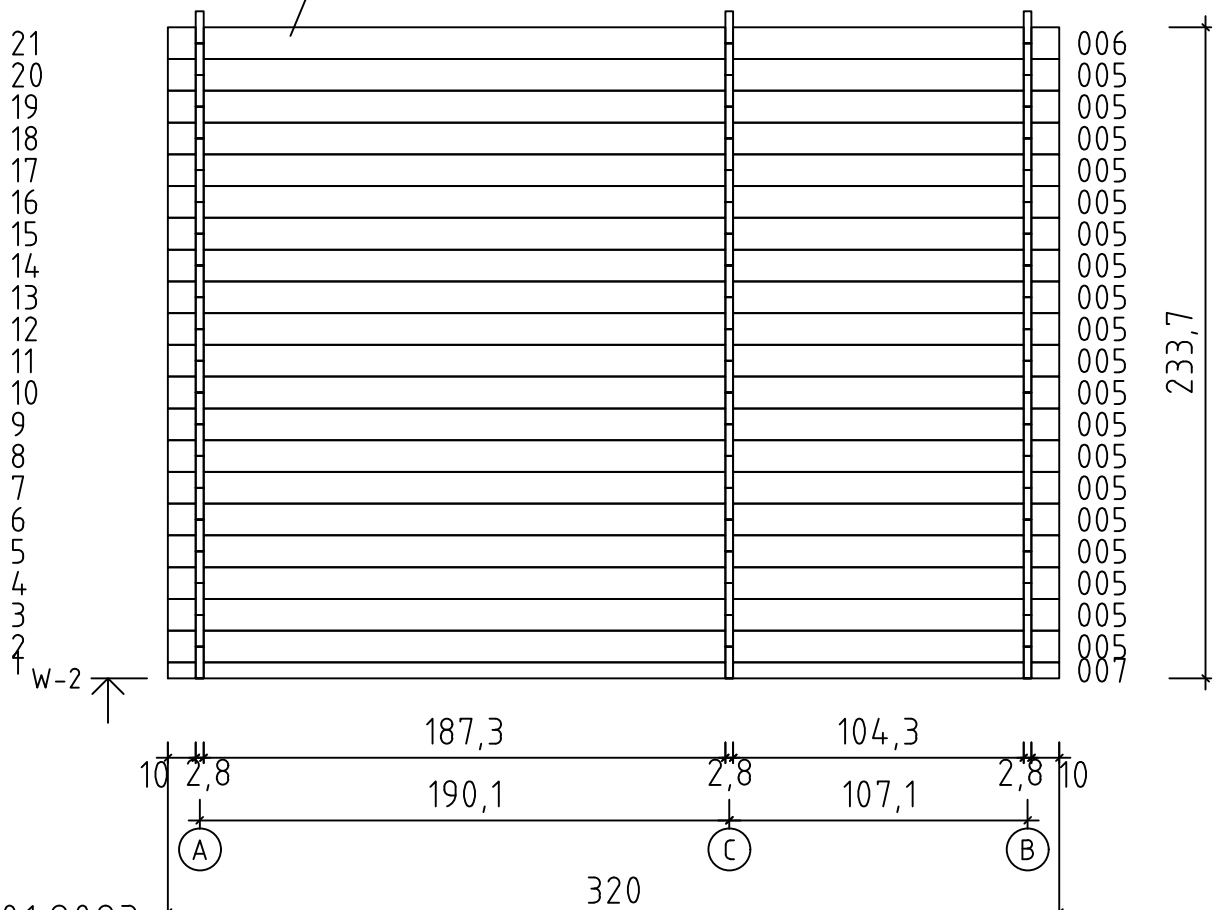



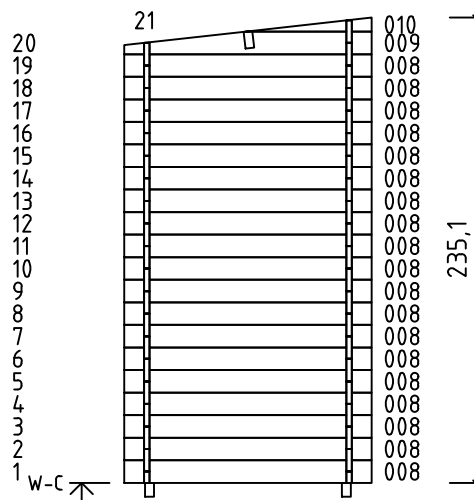
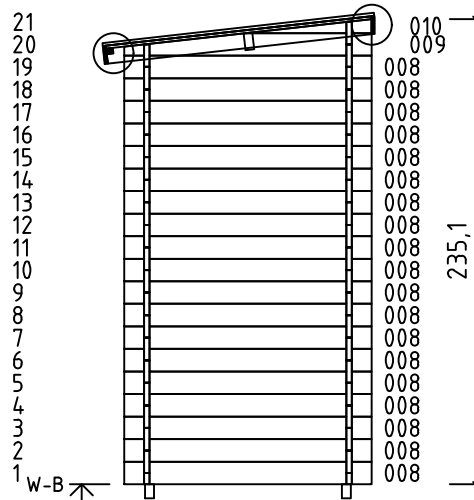
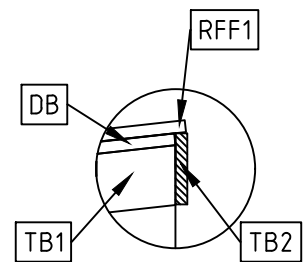
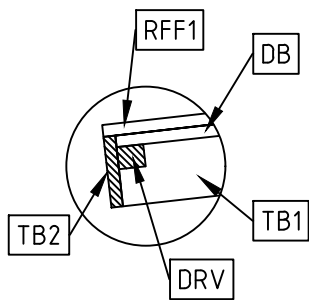
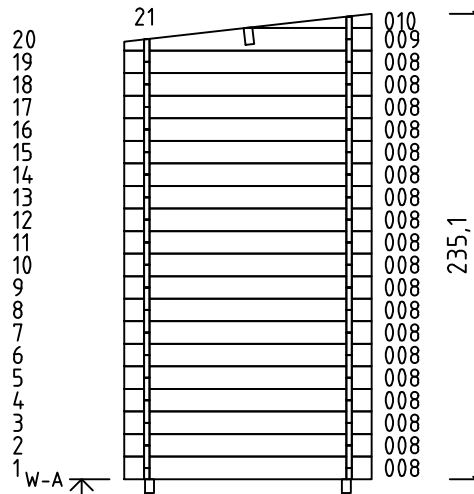

Without tongue - Ohne feder - Madrier de finition -  
Finale in legno - Zonder veer - Punnita



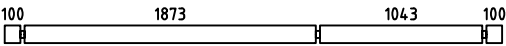
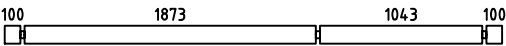
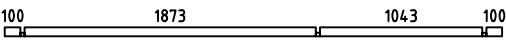
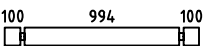
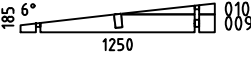
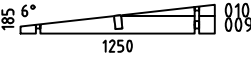
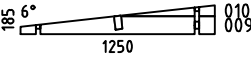
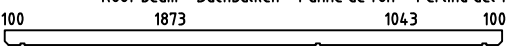
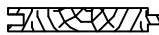

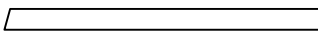
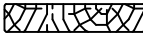

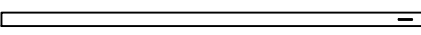
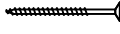
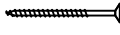
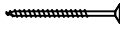
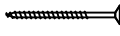

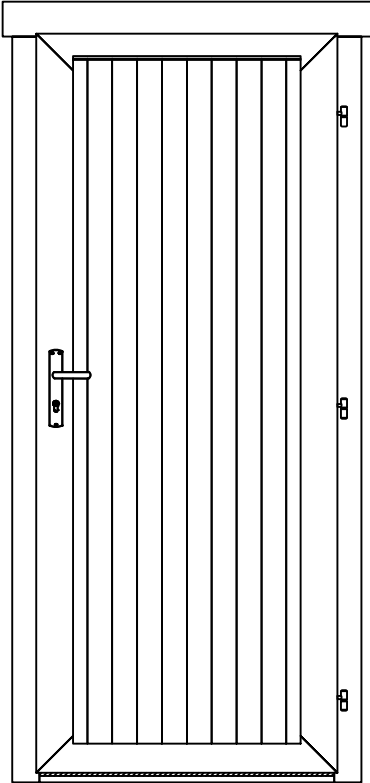
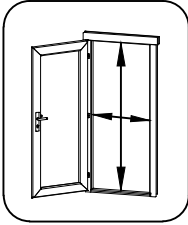

Art. Nr. 2854594

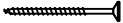

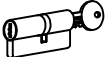
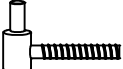
| Pos            | 10.01.2023 Piece list - Stückliste - Liste des pièces - Elementi - Stuklijst - Tükítabel<br>Art. Nr. 2854594 5/6  | Q  | P<br>(mm) | L<br>(mm) |
|----------------|---|----|-----------|-----------|
| 001<br>44658   |    | 2  | 28x57     | 439       |
| 002<br>35151   |    | 1  | 28x57     | 228       |
| 003<br>44659   |    | 34 | 28x114    | 439       |
| 004<br>3751    |    | 17 | 28x114    | 228       |
| 005<br>44660   |    | 20 | 28x114    | 3200      |
| 006<br>44661   |    | 2  | 28x114    | 3200      |
| 007<br>44662   |    | 1  | 28x57     | 3200      |
| 008<br>44651   |    | 57 | 28x114    | 1250      |
| WA-1<br>44652  |    | 1  |           |           |
| WB-1<br>44652  |   | 1  |           |           |
| WC-1<br>44652  |    | 1  |           |           |
| A-PR1<br>44663 | Roof beam - Dachbalken - Panne de toit - Perlina del tetto - Gordingen / dakbalk - Pärilin<br>   | 1  | 44x95     | 3200      |
| DB<br>938      | Roof boards - Dachbretter - Voliges - Perlina per tetto - Dakhout -<br>Katuselaud    | 36 | 90x15     | 1350      |
| RFF1<br>22781  | Roofing felt fillet - Dachpappenleiste - Baguette de fixation du feutre<br>bitumeux - Asse per fissaggio guaina bituminosa - Afdeklijst asfaltpapier -<br>Katusepapiliist    | 2  | 15x45     | 1380      |
| RFF2<br>22391  | Roofing felt fillet - Dachpappenleiste - Baguette de fixation du feutre<br>bitumeux - Asse per fissaggio guaina bituminosa - Afdeklijst asfaltpapier -<br>Katusepapiliist    | 1  | 15x45     | 3140      |
| TB1<br>44654   | Fascia board - Traufbrett - Bandeau de toit - Finitura lati tetto - Gevellijst -<br>Räästalaud    | 2  | 15x90     | 1350      |
| TB2<br>34015   | Fascia board - Traufbrett - Bandeau de toit - Finitura lati tetto - Gevellijst -<br>Räästalaud   | 2  | 15x90     | 3230      |
| DRV<br>2674    | Roof edge reinforcement - Dachrandverstärkung - Corniere de renfort de bord<br>de toit - Rinforzo x tetto - Dakrand versterking - Räästatugevdus   | 1  | 28x34     | 3200      |
| KFS-1<br>27180 | Storm protection - Sturmleiste - Latte anti-tempete - Protezione anti vento -<br>Stormverankering / beveliging - Tormikinnitusliist   | 6  | 22x45     | 2500      |
| HS12<br>5109   | Screw for fascia boards - Schrauben für traufbretter - Vis pour fixation<br>bandeau de toit - Viti x striscia del tetto - Schroef voor gevellijst - Kruvi<br>räästalauale    | 28 | 4x40      |           |
| HS12<br>5109   | Screw for roof edge reinforcement - Schrauben für dachrandverstärkung - Vis<br>pour fixation corniere renfort de bord de toit - Viti x rinforzo bordo tetto -<br>Schroef voor dakrand versterking - Kruvi räästatugevdusele  | 8  | 4x40      |           |
| HS18<br>5113   | Screw for roof beams - Schrauben für dachbalken - Vis pour fixation pannes<br>de toit - Viti per perline del tetto - Schroef voor gordingen / dakbalken -<br>Kruvi pärlinitele   | 3  | 5x120     |           |
| HS18<br>5113   | Screw for gable - Schrauben für giebel - Vis pour fixation des pignons - Viti<br>per timpano - Schroef voor gevelpunt - Kruvi viilude kinnitamiseks    | 6  | 5x120     |           |

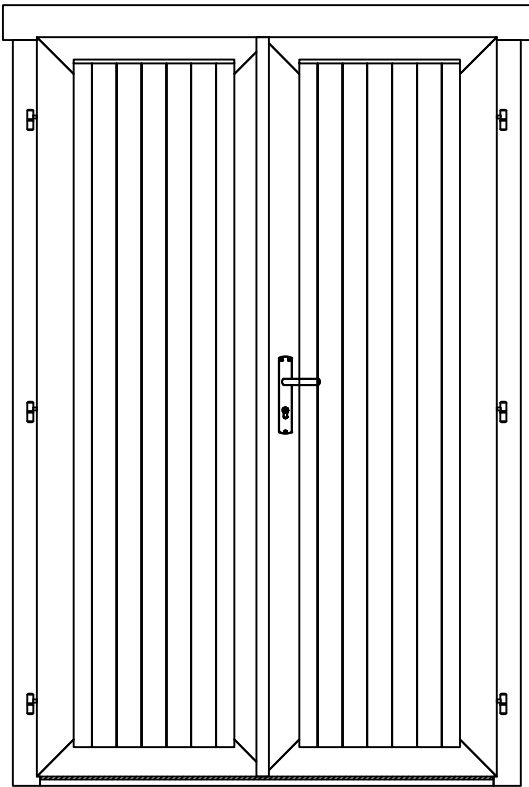
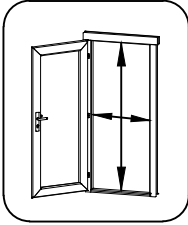
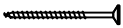
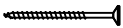
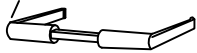
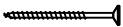

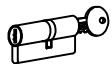
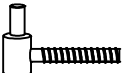
| Pos  | 09.01.2023   | Piece list - Stückliste - Liste des pièces - Elementi - Stuklijst - Tükitalabel<br>835x1957 UL.2.100.IVP.MMW TC+O  | 1/1 | Q      | P<br>(mm) | L<br>(mm) |
|------|--|--|-----|--------|-----------|-----------|
|      |  |   <p>735x1907 mm</p> |     |        |           |           |
| HS16 | Screw for door jamb - Schraube für Türrahmen - Vis de fixation partie haute avec montants du cadre de porte - Viti x fissaggio montanti porte - Schroef voor deurkozijn - Kruvi ukse lengile |   | 4   | 5x90   |           |           |
| HS25 | Screw for doorstep - Schrauben für swelle - Vis pour fixation barre de seuil - Vite per soglia della porta - Schroef voor deurdorpel - Kruvi lävepakule                                      |   | 2   | 4.5x65 |           |           |
| TL4  | Door handle fittings - Türgriff - Poignée de porte - Maniglie - Deurhendel / klink - Ukse käepide  |   | 1   |        |           |           |
| TL5  | Set of door lock covers - Schlossblenden - Set de garnitures de porte - Copertura serrature - Slot sluitplaat set - Ukse lukuplaat   |   | 1   |        |           |           |
|      | Cylinder lock - Zylinderschloss - Barillet de porte - Serratura - Cylinder slot - Ukse lukusüdamik   |   | 1   | 30x35  |           |           |
|      | Male bolt hinge for door - Türband - Partie male de paumelle de porte - Cerniera anube x porta - Scharnier bout - Ukse polthing isane  |   | 3   |        |           |           |

| Pos  | 09.01.2023 Piece list - Stückliste - Liste des pièces - Elementi - Stuklijst - Tükítabel<br>1244x1957 TUL.2.100.IVP.MMWe TC+0  | 1/1   | Q | P<br>(mm) | L<br>(mm)    |
|------|--|---|---|-----------|--------------|
|      |   |   |   |           |              |
|      |   |   |   |           | 1144x1907 mm |
| HS4  | Screw for door fillet - Schraube zur Befestigung türleiste - Vis pour fixation baguette d'arrêt de porte - Viti per massellino della porta - Schroef voor deurlijst - Kruvi ukse kokkuvältsiliistule |  | 5 | 3x30      |              |
| HS16 | Screw for door jamb - Schraube für Türrahmen - Vis de fixation partie haute avec montants du cadre de porte - Viti x fissaggio montanti porte - Schroef voor deurkozijn - Kruvi ukse lengile         |  | 6 | 5x90      |              |
| TL4  | Door handle fittings - Türgriff - Poignée de porte - Maniglie - Deurhendel / klink - Ukse käepide VU   |  | 1 |           |              |
| HS25 | Screw for doorstep - Schrauben für swelle - Vis pour fixation barre de seuil - Vite per soglia della porta - Schroef voor deurdorpel - Kruvi lävepakule  |  | 3 | 4.5x65    |              |
| TL5  | Set of door lock covers - Schlossblenden - Set de garnitures de porte - Copertura serrature - Slot sluitplaat set - Ukse lukuplaat   |  | 1 |           |              |
|      | Cylinder lock - Zylinderschloss - Barillet de porte - Serratura - Cylinder slot - Ukse lukusüdamik   |  | 1 |           |              |
|      | Male bolt hinge for door - Türband - Partie male de paumelle de porte - Cerniera anube x porta - Scharnier bout - Ukse polthing isane  |  | 6 |           |              |
|      | Striker for barrel bolt - Hülse für Grendelriegel - Gache au sol du targette - Boccola per fermo della porta - Huls voor vergrendelingsschuif - Vasturaud ukse servariivile                          |  | 2 |           |              |