

Cyprus 1D
Art. Nr. 280100
1/7



10.02.2017

Art.Nr. 280100

GROUNDPLAN - GRUNDPLAN - PLAN DE MASSE

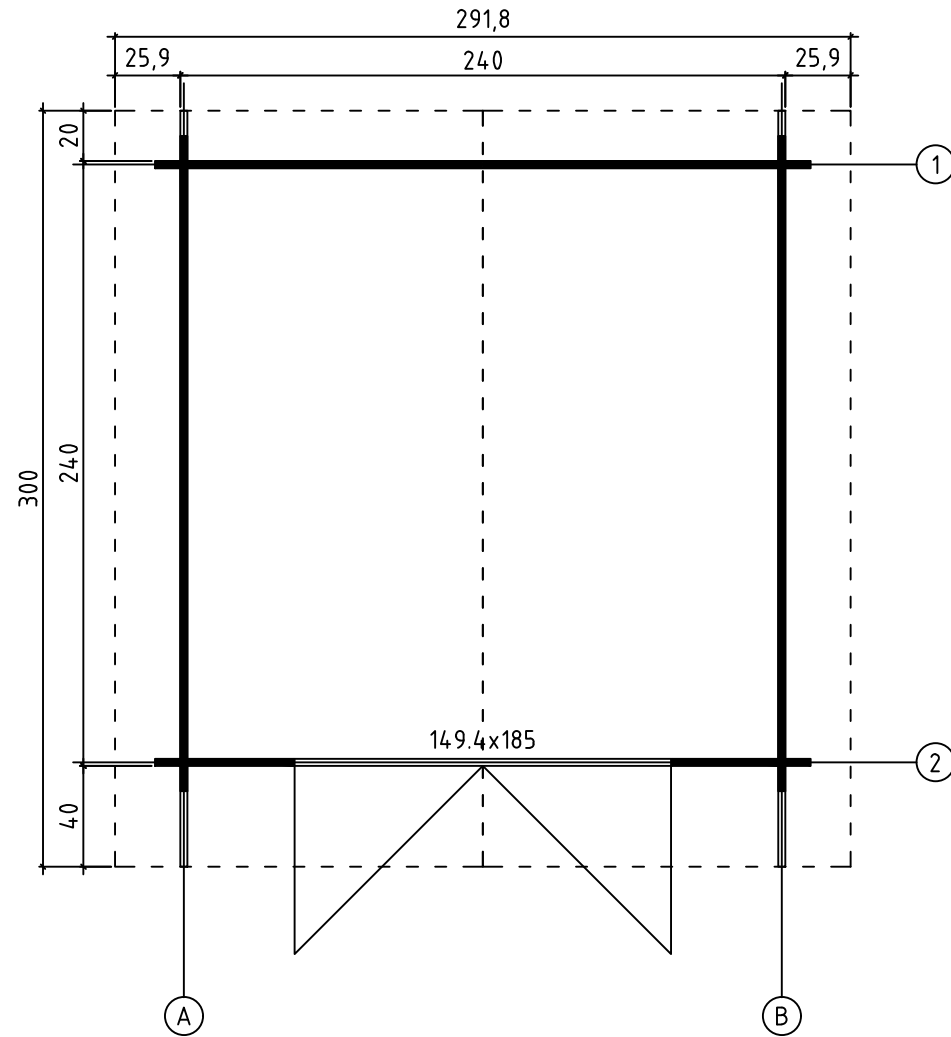

Art.Nr. 280100

FOUNDATION - FUNDAMENT - FONDAATION

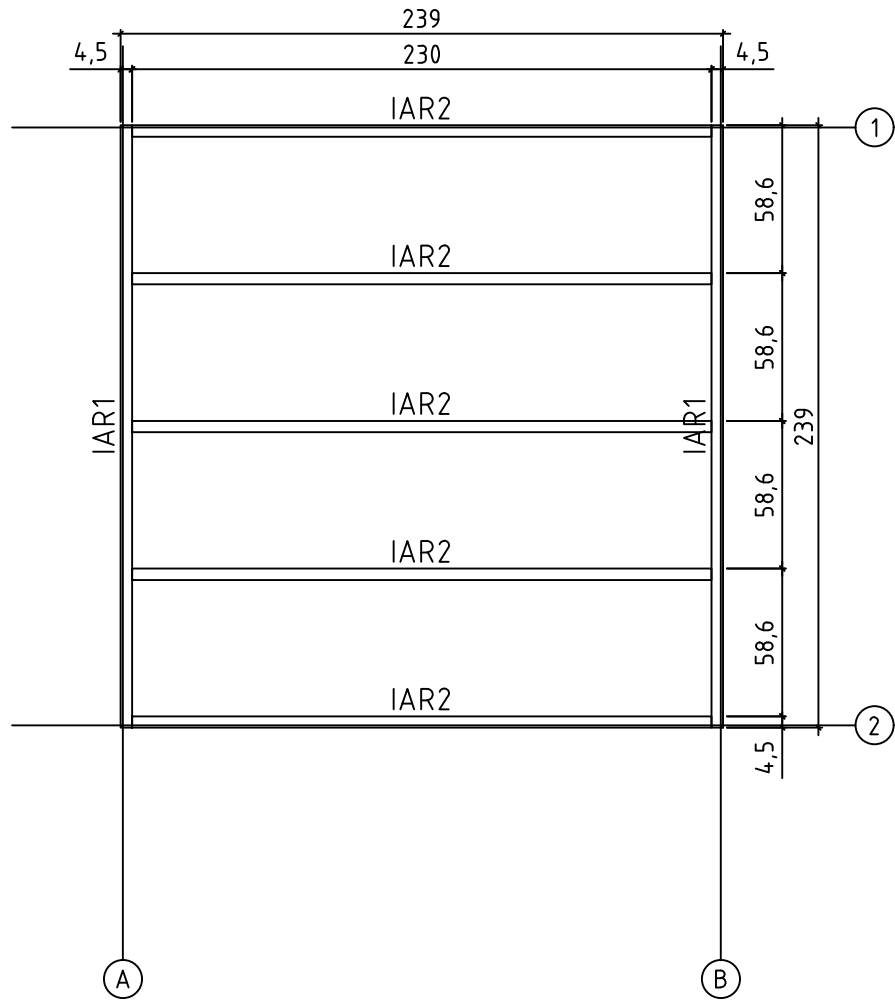

FLOOR BOARDS - FUSSBODENBRETTER -
- PLAN POSE PLANCHER

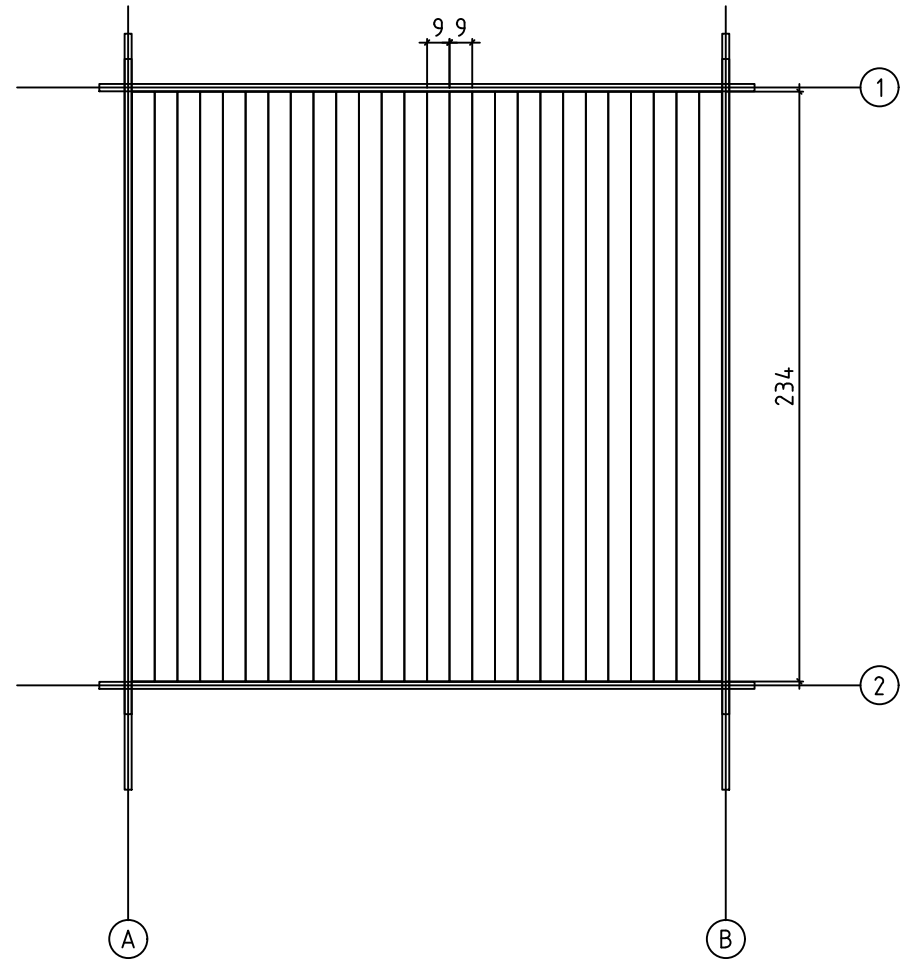



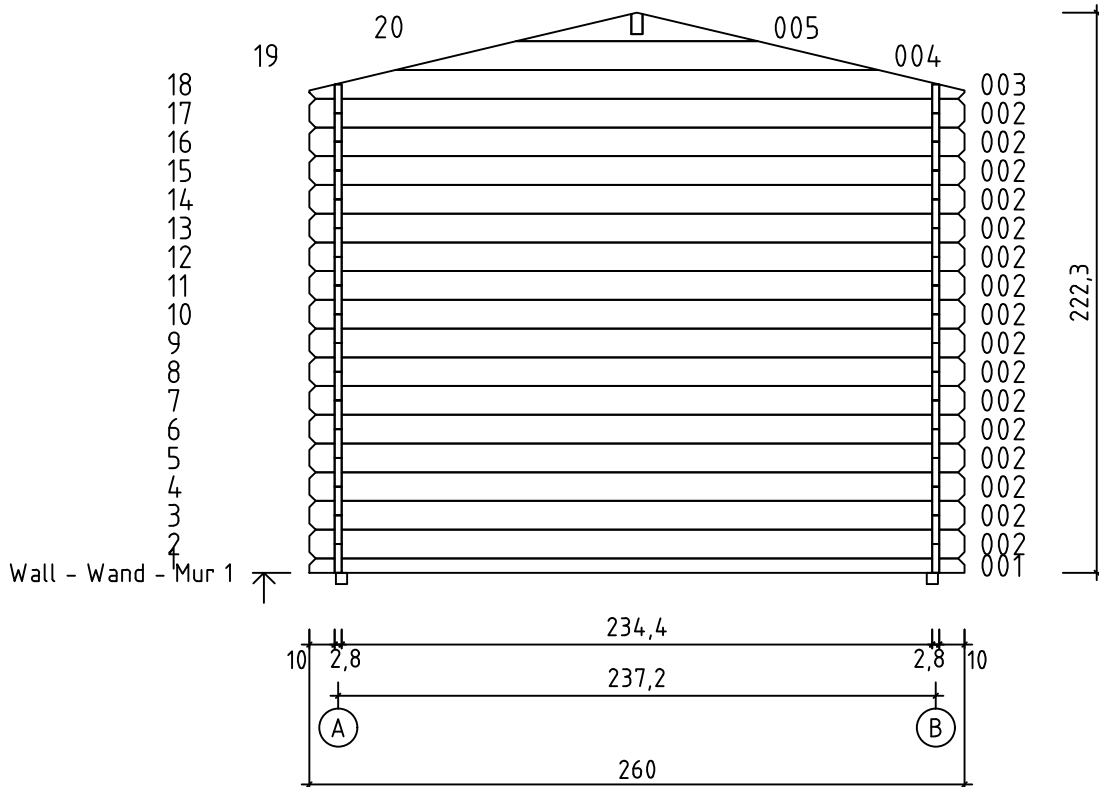
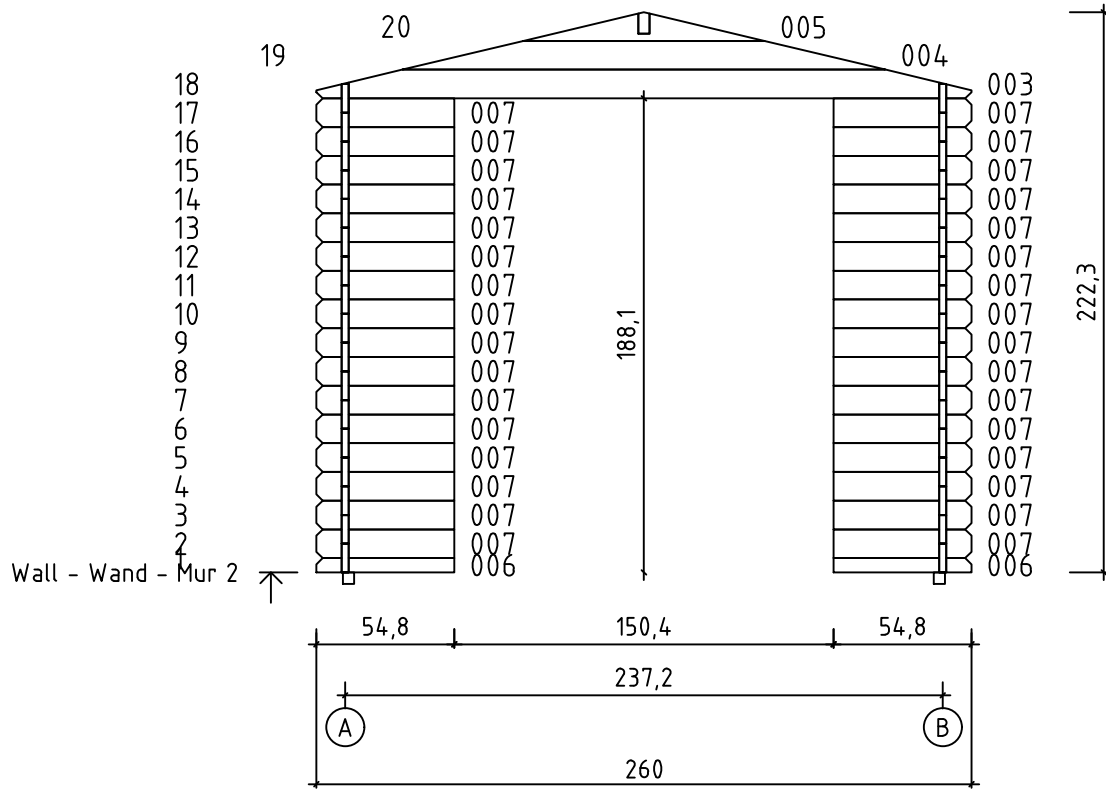



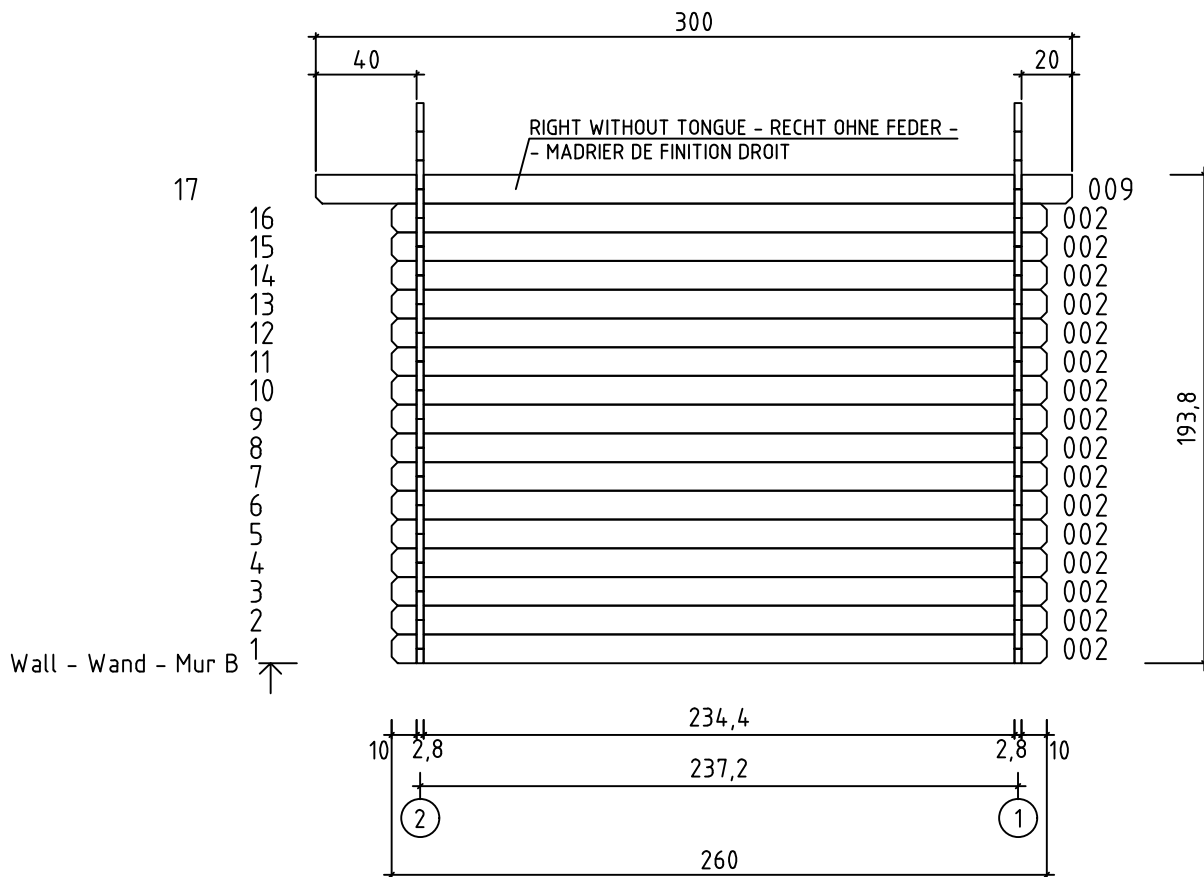
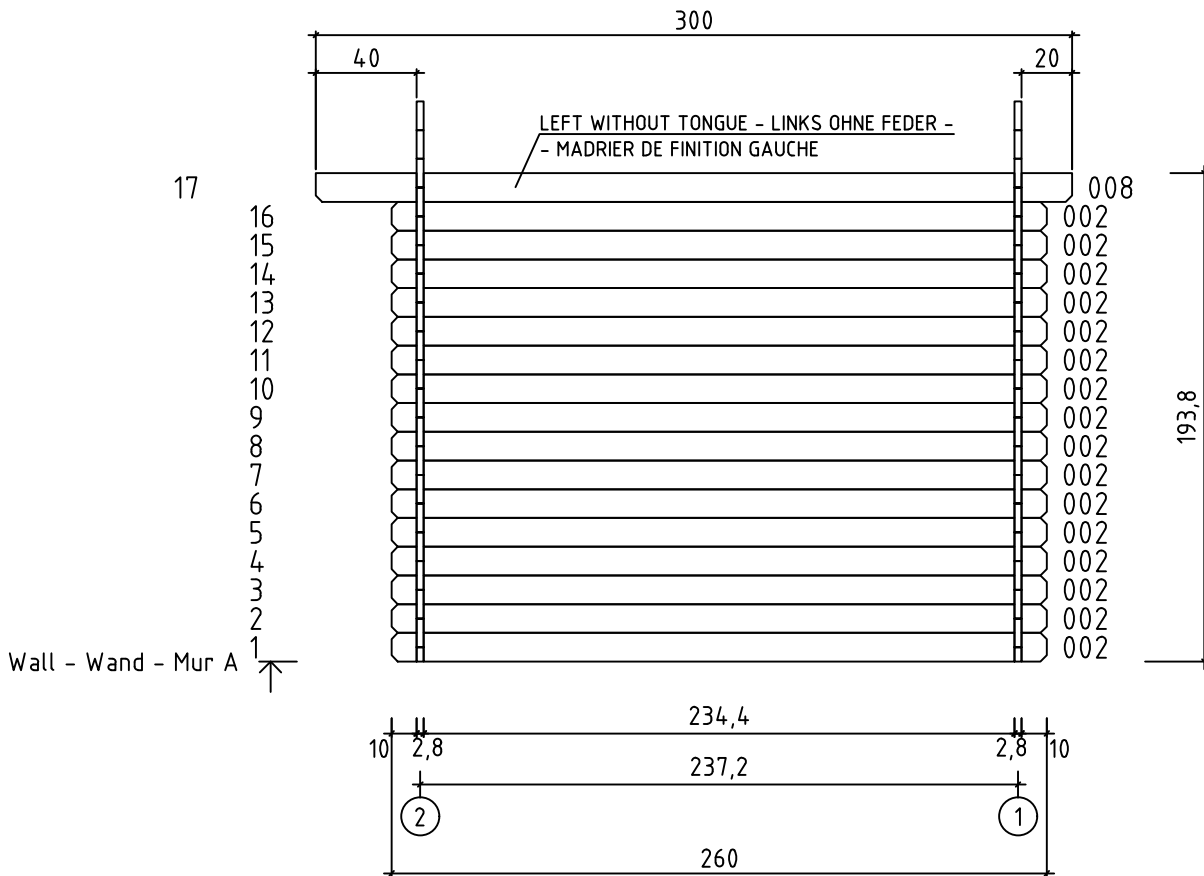

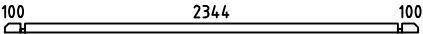
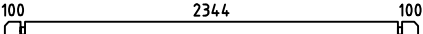

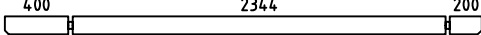
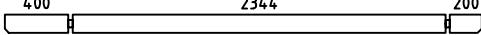
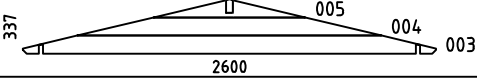
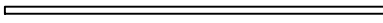
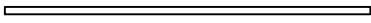
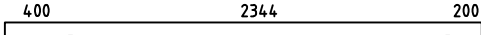





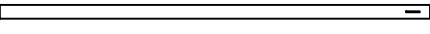
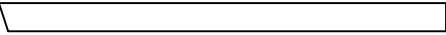
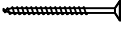
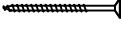



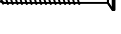



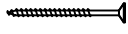



Art.Nr. 280100

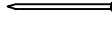
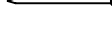
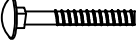

Art.Nr. 280100

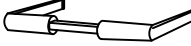

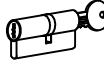
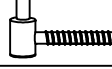
Pos	10.02.2017	Piecelist - Stücklist - Liste des composants Art.Nr. 280100	6/7	Q.	P. (mm)	L. (mm)
001				1	28x57	2600
002				48	28x114	2600
006				2	28x57	548
007				32	28x114	548
008				1	28x120	3000
009				1	28x120	3000
W1-1				1		
W2-1				1		
IAR1		FOUNDATION - FUNDAMENT - FONDATION		2	45x45	2390
IAR2		FOUNDATION - FUNDAMENT - FONDATION		5	45x45	2300
PR11		ROOF BEAM - DACHBALKEN - PANNE DE TOIT		1	44x120	3000
	FLOOR BOARDS - FUSSBODENBRETTER - LAME DE PLANCHER			26	90x18	2340
	ROOF BOARDS - DACHBRETTER - VOLIGES			68	90x18	1500
	FLOOR FILLET - FUSSBODENLEISTE - CORNIERE DE FINITION DU PLANCHER				18x18	9.36
	ROOFING FELT FILLET - DACHPAPPENLEISTE - BAGUETTE DE FIXATION DU FEUTRE BITUMEUX			4	18x58	1550
	FASCIA BOARD - TRAUFBRETT - BANDEAU DE TOIT			2	18x90	3000
	ROOF EDGE REINFORCEMENT - DACHRANDVERSTÄRKUNG - CORNIERE DE RENFORT DE BORD DE TOIT			2	28x34	3000
KFS-1	STORM PROTECTION - STURMLEISTE - - LATTE ANTI-TEMPETE			4	22x45	2050
	GABLE MOULDING - GIEBELLEISTE - - PLANCHE DE RIVE			4	18x120	1550
	SCREW FOR GEORGIAN BARS - SCHRAUBE FÜR SPROSSEN - VIS POUR FIXATION CROISILLONS BOIS DES MENUISERIES			12	2.5x20	
HS12	SCREW FOR GABLE SEGMENT - SCHRAUBEN FÜR DECKBLATT - VIS POUR FIXATION LOSANGE DE FINITION			4	3.5x35	
HS16	SCREW FOR GABLE MOULDING - SCHRAUBEN FÜR GIEBELLEISTE - VIS POUR FIXATION PLANCHE DE RIVE			16	3.5x50	
HS3	SCREW FOR DOOR FILLET - SCHRAUBE ZUR BEFESTIGUNG TÜRLEISTE - VIS POUR FIXATION BAGUETTE D'ARRET DE PORTE			5	3x30	
HS32	SCREW FOR FASCIA BOARDS - SCHRAUBEN FÜR TRAUFBRETTER - VIS POUR FIXATION BANDEAU DE TOIT			14	4x40	
	SCREW FOR ROOF EDGE REINFORCEMENT - SCHRAUBEN FÜR DACHRANDVERSTÄRKUNG - VIS POUR FIXATION CORNIERE RENFORT DE BORD DE TOIT			14	4x40	
HS43	SCREW FOR GABLE - SCHRAUBEN FÜR GIEBEL - VIS POUR FIXATION			4	5x120	

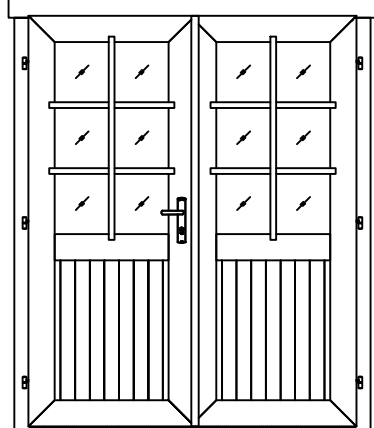
Pos	10.02.2017	Piecelist - Stücklist - Liste des composants Art.Nr. 280100	7/7	Q.	P. (mm)	L. (mm)
HS43		SCREW FOR ROOF BEAMS - SCHRAUBEN FÜR DACHBALKEN - VIS POUR FIXATION PANNES DE TOIT		2	5x120	
		SCREW FOR 1. WALL BEAM - SCHRAUBE FÜR 1. BOHLENREIHE - VIS DE FIXATIONS 1ÈRE RANGÉE DE MADRIERS AVEC POUTRELLES DE FONDATIONS		6	5x90	
		SCREW FOR FOUNDATION - SCHRAUBEN ZUR BEFESTIGUNG FUNDAMENT - VIS DE FIXATIONS DES POUTRELLES DE FONDATIONS		10	5x90	
HS41		SCREW FOR DOOR JAMB - SCHRAUBE FÜR TÜRRAHMEN - VIS POUR FIXATION MONTANT DE PORTE		4	5x90	
HS59		SCREW FOR DOORSTEP - SCHRAUBEN FÜR SWELLE - VIS POUR FIXATION BARRE DE SEUIL		3	4.5x65	
		ZN NAIL FOR FLOOR FILLET - ZN NÄGEL FÜR FUSSBODENLEISTE - POINTE POUR CORNIERE DE FINITION DU PLANCHER		20	1.4x40	
SH28		HAMMER BLOCK - SCHLAGHOLZ - CALLE DE FRAPPE		1		
SFS		NUT FOR STORM PROTECTION - SCHRAUBENMUTTER FÜR STURMLEISTE - ECROU POUR LATTE ANTI-TEMPETE		8	D6	
NF2		ZN NAIL FOR ROOF - ZN NÄGEL FÜR DACHBRETTER - POINTE POUR FIXATION VOLIGES DE TOIT		144	2x50	
		ZN NAIL FOR FLOOR - ZN NÄGEL FÜR FUSSBODENBRETTER - CLOUS POUR PLANCHER		135	2x50	
NFD		ZN NAIL FOR ROOFING FELT FILLET - ZN NÄGEL FÜR DACHPAPPENLEISTE - POINTE POUR BAGUETTE DE FIXATION FEUTRE BITUMEUX		16	2x40	
BFS		BOLT FOR STORM PROTECTION - BOLZEN FÜR STURMLEISTE - BOULON POUR LATTE ANTI-TEMPETE		8	6x60	
GS		GABLE SEGMENT - DECKBLATT - LOSANGE DE FINITION		2		
DFS		WASHER FOR STORM PROTECTION - DICHTSCHEIBE FÜR STURMLEISTE - RONDELLE POUR LATTE ANTI-TEMPETE		8	D6	
TL4		DOOR HANDLE FITTINGS - TÜRGRIF - POIGNEE DE PORTE		1		
TL5		SET OF DOOR LOCK COVERS - SCHLOSSBLENDEN - SET DE GARNITURES DE PORTE		1		
		CYLINDER LOCK - ZYLINDERSCHLOSS - BARILLET DE PORTE		1	30/35	
		MALE BOLT HINGE FOR DOOR - TÜRBAND - PARTIE MALE DE PAUMELLE DE PORTE		6	16/52	
		STRIKER FOR BARREL BOLT - HÜLSE FÜR GRENDDELRIEGEL - GACHE AU SOL DU TARGETTE		2		
		DOOR - TÜR - PORTE 1494x1850		1		
		TUK.2.056.SVV.MMc SGC				