

PANELS WITH MILLED LINES

CEWOOD Panels with milled lines offer the same acoustic properties as regular CEWOOD Panels, but with the added aesthetic feature of decorative grooves on the surface. You can choose from a variety of pre-designed milled line patterns, or create your own design to suit your specific needs and preferences.

For installation and handling guidelines, refer to the documentation available in the "Downloads" section, as these panels do not differ from standard CEWOOD Panels in terms of installation and use.

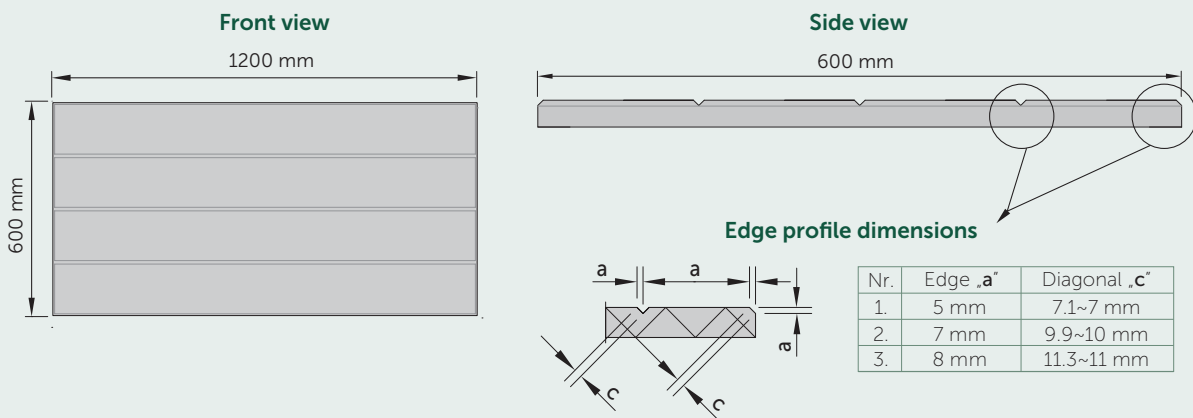
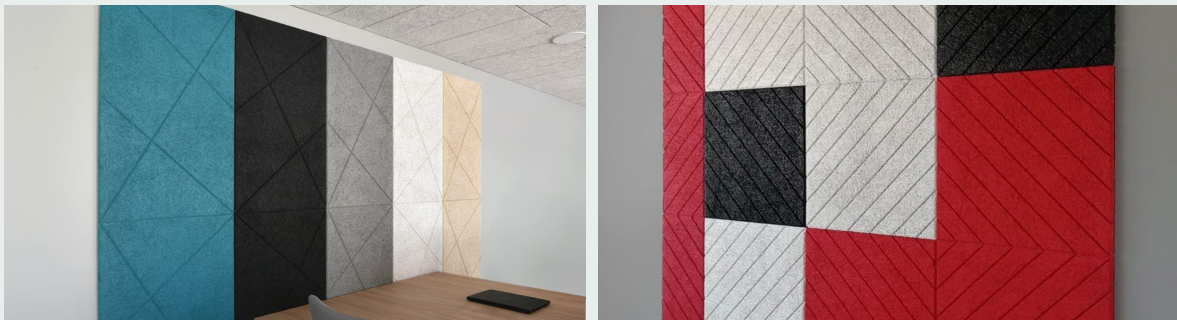

CEWOOD Panels with milled lines - 1,0 mm wood wool

Thickness	mm	25	35
Standard size	mm	2400x600; 1200x600; 600x600; other sizes upon request	
Dimensional tolerance (EN 13168)		L4; W2; T2; S2; P2	
Weight	kg/m ²	10,5	14,5
Density	kg/m ³	420	410

Thermal resistance (R ₀)	m ² ·K/W	0,35	0,50
Thermal conductivity (λ _D)	W/m·K	0,069	
Bend (EN 12089)	kPa	≥ 1300	≥ 1000
Compression (EN 826)	kPa	≥ 300	≥ 200
Chloride content (EN 13168)	%	≤ 0,06 class Cl3	
Reaction to fire (EN 13501-1:2007)		B-s1, d0	

COMMON MILLED PANEL DESIGNS



An office wall design with four different types of milled panels in different colours.

FR-TYPE1

Rectangle

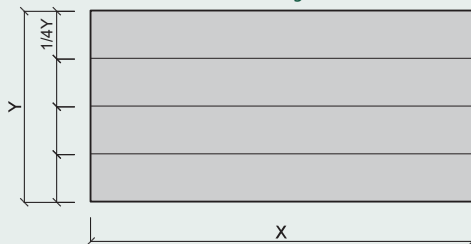

Square

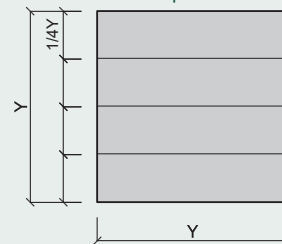

FR-TYPE2

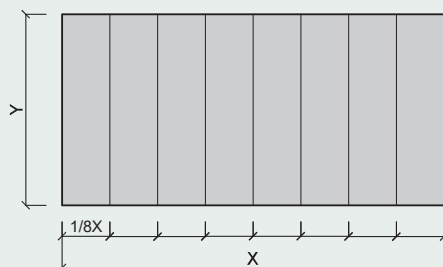

COMMON MILLED PANEL DESIGNS

FR-TYPE3

Rectangle

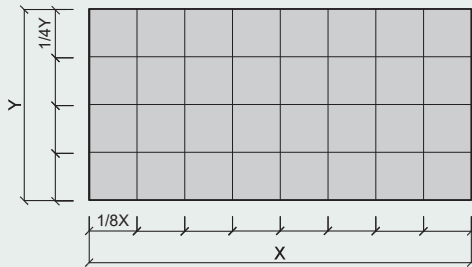

Square

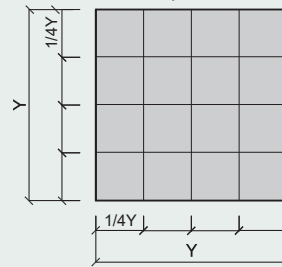

FR-TYPE4

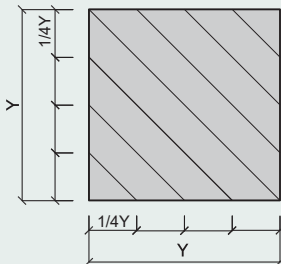

FR-TYPE4-L

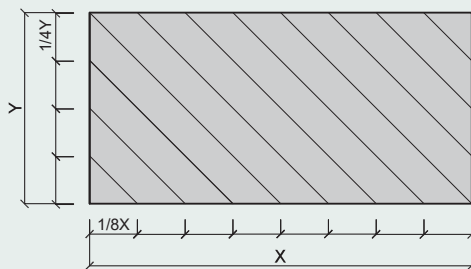

FR-TYPE4-R

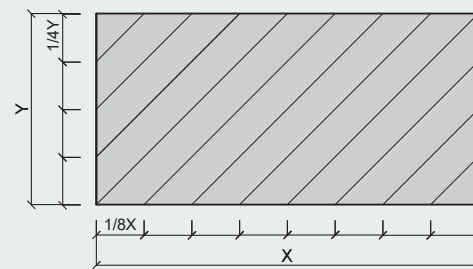

FR-TYPE5

Rectangle

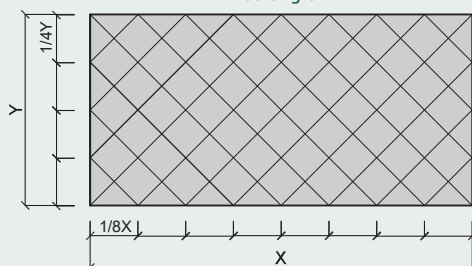

Square

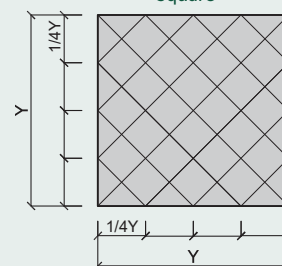

COMMON MILLED PANEL DESIGNS



An art object on the hall wall created from five different types of milled panels in one colour.

FR-TYPE6-L

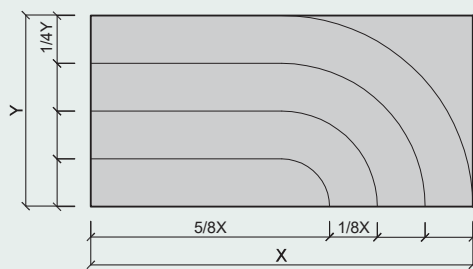

FR-TYPE6-R

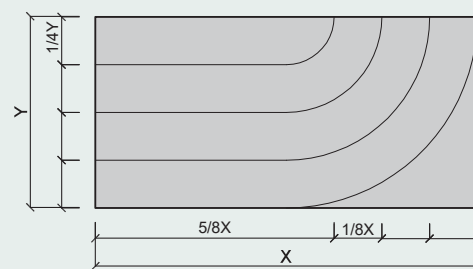

FR-TYPE7

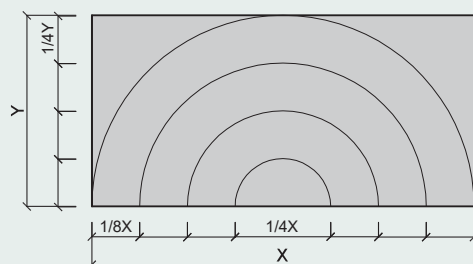

COMMON MILLED PANEL DESIGNS



A children's room with a statement wall in a bold colour adds visual interest to the space.

FR-TYPE8-L

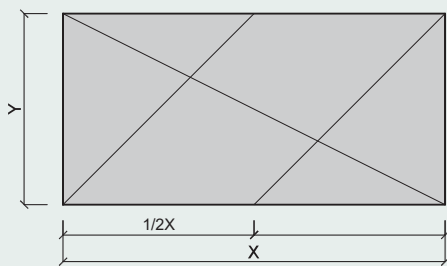

FR-TYPE8-R

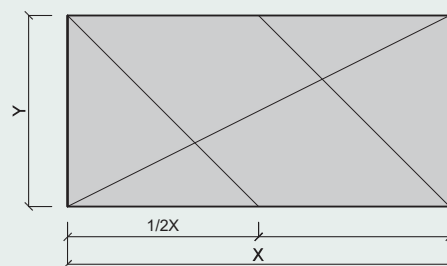

FR-TYPE9

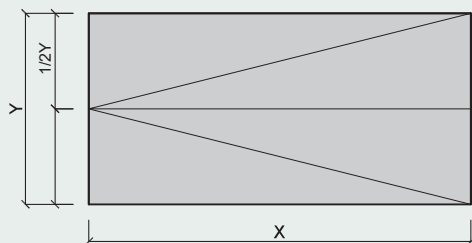

FR-TYPE10

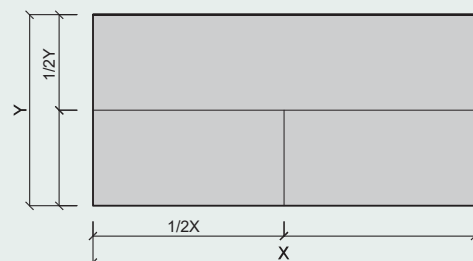

COMMON MILLED PANEL DESIGNS



The kitchen interior is complemented beautifully by the black wall of milled panels.

FR-TYPE11

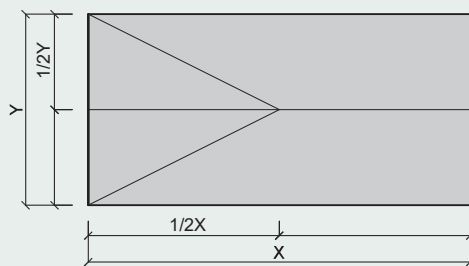

FR-TYPE12

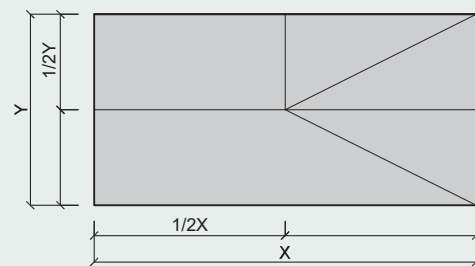

FR-TYPE13-R

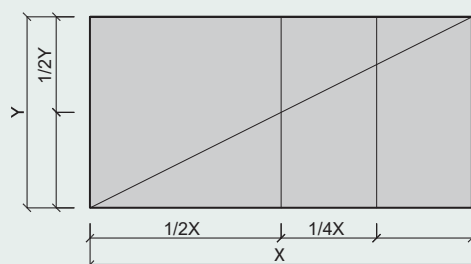

FR-TYPE13-L

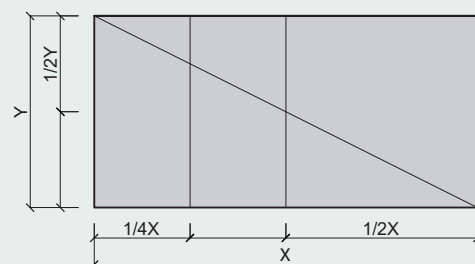

COMMON MILLED PANEL DESIGNS



An office wall with two types of milled panels in different colours.

FR-TYPE14-R

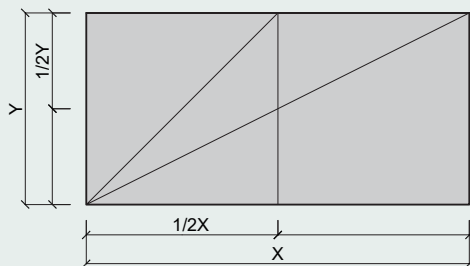

FR-TYPE14-L

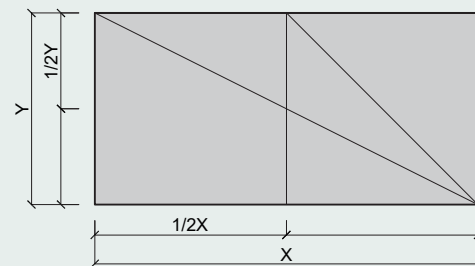

FR-TYPE15

