

BALTECO

BATHROOMS



TETRIS

User manual

1. IMPORTANT SAFETY

- CAUTION: Never allow children to use the bath/shower cabin without adult supervision to avoid accidents.
- CAUTION: Physically challenged people must exercise extreme caution and/or use assistance if necessary when using bath/shower cabin.
- CAUTION: Do not use external electrical devices while taking a bath or shower. Devices located at the bath's vicinity, being connected into electricity network, must be fastened in such a way as to avoid their accidental falling.
- CAUTION: Upon failure/damage or abnormal functioning of any appliances of the bath/shower cabin a technical maintenance professional must be called. Use of damaged product or product with failure of any type is strictly forbidden.
- Before using the bath, check the water temperature in the bath. Suitable is water temperatures up to 40°C. Pouring over 60°C water into the bath/shower cabin may damage the material.
- Do not use the bath/shower cabin when being intoxicated with alcohol or drugs.
- Take care when entering or leaving the bath/shower cabin to avoid injuries.
- Consult your physician before using the bath when you're pregnant or suspect pregnancy.
- Consult your physician before using the bath when being sick.
- All the openings of the bath/shower cabin must be clean and unobstructed.

2. OPERATION

To switch the display on, press on/off button A. For a moment the display will indicate time, temperature and all the icons of currently inactive functions (chromo/light B, steam D, radio C, hydromassage F, and setup).

To deactivate all functions, pressing on/off button A again, display enters into standby mode. The clock reading after connecting the product to the power network is 00:00. In order to adjust the clock reading (00:00), you need to set the time (see Section 2.6.). In case of power failure the clock reading will reset to 00:00 (unless the power failure lasts less than 5 minutes).

All functions become inactive and the display will enter into stand-by mode (only the indicator of errant time is lit on the display) 60 minutes after pressing any button or 20 minutes after deactivating the last function. If the product is connected to the power network, the control panel will show the so-called errant time.

All functions can be activated after pressing button A to switch on the steam sauna. In order to switch a function on:

- 1) use a quick button,
- 2) use buttons X/Y to select the icon of deactivated function and press OK button.

CONTROL PANEL

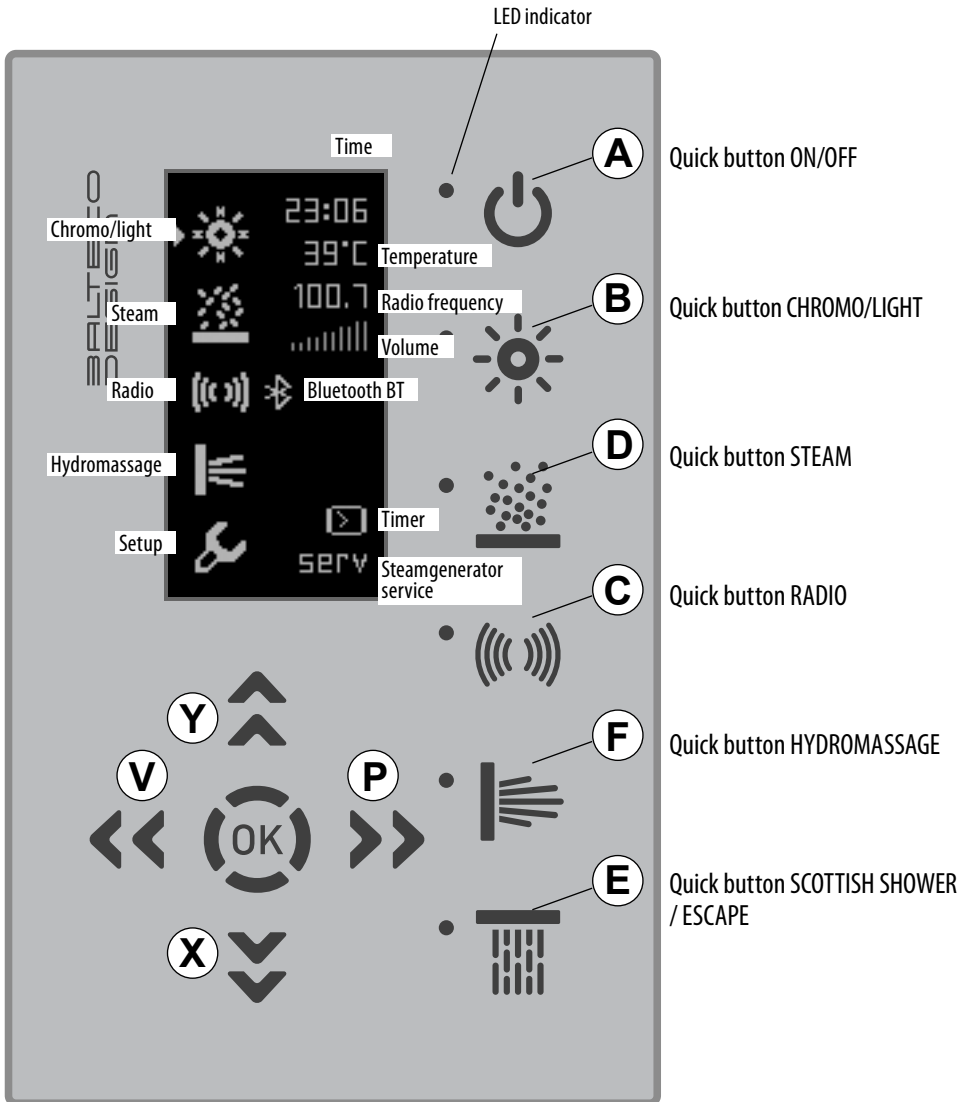

2.1 CHROMOTHERAPY / LIGHT

Quick button is available on the control panel.

Button B allows switching the function on/off. After pressing button B, 3 white LED lamps light up, the chromotherapy function icon on the display is activated and the led indicator next to the button lights up. In this mode you can manually choose/switch between (7 different) colours by pressing left/right buttons. “Chromotherapy” submenu will open after pressing OK button, while the cursor is at the active chromotherapy icon. The screen will show the following icons (from top to bottom):

- 1) automatic mode,
- 2) manual mode,
- 3) exit setup

In order to choose suitable setting (e.g. automatic), use buttons X/Y to select desired icon and press OK button. After pressing OK button the function will be set to automatic mode, activation of which is indicated by rotating chromotherapy/light icon in the main menu.

Display will stop showing “chromotherapy” submenu if you:

- have not pressed any of the buttons within 20 seconds,
- use buttons X/Y to select chromotherapy icon and press OK button,
- use buttons X/Y to select exit setup icon and press OK button,
- press button B, i.e. deactivate the function,
- press button E, i.e. return to main menu.

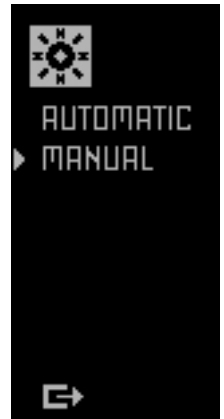

Exit

2.2. RADIO

Quick button on the control panel.

Press button C to switch the function on/off.

The radio will play the two most recently selected stations (used last time) when pressing button C. At the same time active radio icon and radio station frequency will be shown on the display, LED indicator next to the button will light up and cursor will move to the activated icon. It is then possible to adjust the volume by using left/right buttons. Use 'left' button to reduce volume and 'right' button to increase volume. If the cursor is at the radio icon and the icon is activated, press OK button to open “radio” submenu. See the picture. Use buttons X/Y to select memory slots for radio station in the “radio” submenu, the radio will operate at the frequency saved under corresponding memory slot.

Display will stop showing “radio” screen if you:

- have not pressed any of the buttons within 20 seconds,
- use buttons X/Y to select radio icon and press OK button,
- use buttons X/Y to select the exit setup icon and press OK button,
- press button C, i.e. switch the function off,
- press button E, i.e. return to main menu.

NB! In order to allow more comfortable adjustment of radio volume, the cursor will automatically go to the radio icon if no buttons have been pressed within 1 minute, provided that the radio is switched on.

Searching and saving radio stations

In order to search radio stations, open “radio” submenu on the display. Then use buttons X/Y to select the number of the memory slot and left/right buttons to search for stations. Short press (press the button for up to 2.5 seconds) allows manual search for radio stations. If you hold the left/right button down for longer than 2.5 seconds, the radio will enter into automatic search mode, i.e. the search will halt when finding a radio station.

Press OK button to save a radio station (the icon indicating the frequency (numbers) must be activated and the cursor must be in front of the icon). The station frequency of the first memory slot starts to blink. If you want to save the selected frequency under a memory slot other than the first one, then use buttons X/Y to select relevant memory slot. After selecting a memory slot (station frequency is blinking), press OK button. The frequency is saved and the radio will continue broadcasting the selected station.

(closed position).

Setting the timbre

Use buttons X/Y to select the timbre icon shown on the display in “radio” submenu and press OK button, the display will show all four versions of timbre icon. Currently saved timbre icon is shown as active. When selecting corresponding timbre versions by using left/right buttons, the timbre will change immediately, but it will not be saved. Press OK button to save the selected timbre. After pressing OK button, the display will continue showing the icon of the version of saved timbre (in “radio” submenu).

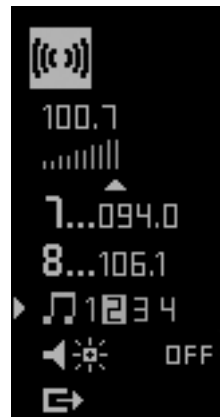
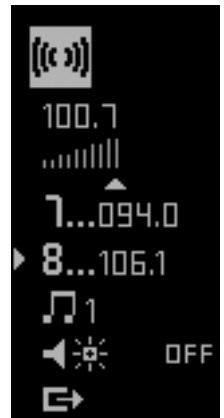

Colour music

Use buttons X/Y to select the colour music icon displayed in “radio” submenu and press OK button, the function will switch on (i.e. the chromotherapy lamps in steam sauna will light up according to the sound) and the icon of four different versions of colour music will be displayed. At the same time the chromotherapy/light icon on the main screen will be activated and the LED indicator next to the chromotherapy/light quick button will light on. When selecting corresponding four versions of the function by using left/right buttons, the settings will change immediately, but the change will not be saved. Press OK button to save the selected version. After pressing OK button the display will continue showing the icon of the selected version of colour music.

Colour music function will switch off after using quick button to switch off chromotherapy/light (button B) or radio (button C).

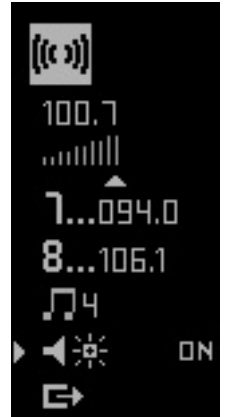

Connecting BLUETOOTH (BT)

A. Connecting BT to the cabin when the cabin is switched off:

- Set your mobile phone or any other device having BT to search for new connections.

- Select from the found devices CABIN AUDIO

- Pair the device's BT with the cabin. When the device has found the cabin's BT, the LED-light of RADIO button starts blinking. To confirm the pairing press the RADIO button within 5 minutes. The cabin is now activated and the cabin's BT is active. When you fail to press the RADIO button within 5 minutes, the LED light goes off and you have to reinitiate the BT pairing. When music is playing, it is directed to the cabin's audio system (if the mobile phone configuration allows this). Incoming calls are directed to the cabin's audio system, if the cabin is connected to BT.

B. Connecting BT to the cabin when the cabin is switched on:

The procedure is the same as described in section A. Differences between sections A and B: To play BT audio you need to activate BT on the panel from RADIO sub-menu. A small BT icon will be displayed on the screen.

N.B. If the device (mobile phone) cannot find the cabin, switch the device or cabin off and then on again.

Music control:

button RADIO = pause/play

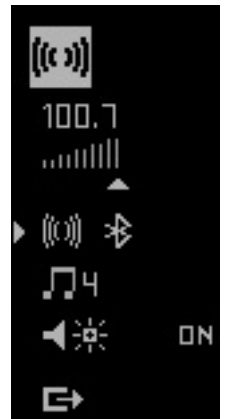

button RADIO (a long press) = BT audio off, BT icon displayed

button RIGHT = sound volume increases

button RIGHT (a long press) = next track

button LEFT = sound volume decreases

button LEFT (a long press) = previous track

You can accept an incoming call (intermittent tone and the text CALL flashing on the screen) by pressing the OK button; you can reject a call by pressing the button ESCAPE / SCOTTISH SHOW-ER. You can adjust the volume with LEFT / RIGHT button.

2.3. STEAM

Quick button on control panel.

Press button D to switch this function on/off. When pressing button D (to switch the function on), the display will show active icon of the steam function, the LED indicator next to the button will light up and the cursor will move to the activated icon and the temperature reading will start to blink. Blinking reading will indicate preselected temperature. Blinking will continue for 10 seconds after switching the function on. Then the reading will start to show current temperature.

Press button D again to switch off steam function. The steam function icon will be deactivated and the LED indicator next to the button will turn off.

Temperature setup

Temperature can only be adjusted if the function is switched on. Use X/Y buttons to select activated steam function icon shown on the display, and press OK button, "steam function" submenu will be shown on the display. See the picture.

In order to set the steam temperature, use buttons X/Y to select the temperature reading and then use left/right buttons to adjust the reading. Press 'left' button to reduce the temperature (min 35°C) and press 'right' button to increase (max 50°C). Press OK button to save the selected temperature. Display will stop showing "steam function" submenu if you:

- have not pressed any of the buttons within 20 seconds,
- use buttons X / Y to select exit setup icon and press OK button,
- press button D, i.e. deactivate the function,
- press button E, i.e. return to main menu.

The most recently set temperature will be saved in the memory.

Indication for achieving the selected temperature

Achieving the selected temperature is indicated (provided that the

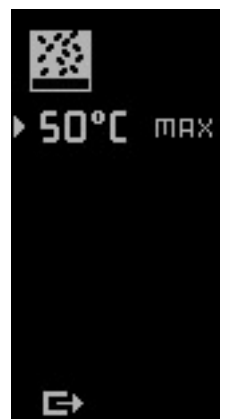
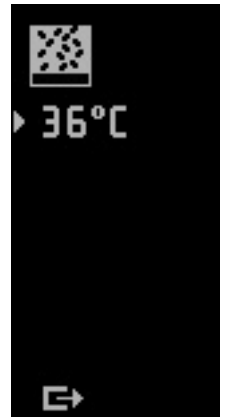

indication for achieving the selected temperature is switched on (see Section 2.6. Setup)) by green ceiling light when reaching the temperature 5°C lower than the set temperature. Green light will be on until pressing any button. After pressing any button the light turns white. Light can be switched off by pressing button B.

Display messages related to steam functions

After switching on the steam, the steam icon starts to blink. If you bring the cursor to steam icon and press OK, the steam submenu will appear on the display.

- If display shows E1, the steam generator is not dispensing water.
- If display shows E3, there is a problem with the power supply of steam generator. SERV – see Section 2.6.

2.4. SCOTTISH SHOWER

Quick button on control panel.

When pressing and holding down button E, only cold water will start to run from the ceiling shower, (only) active Scottish shower icon will be shown on the display and the LED indicator next to the button will light up. The function only works when the display shows main menu!

NB! Press button E while in submenu to return to main menu, i.e. back/escape.

2.5. HYDROMASSAGE

Use Button F to switch the function on/off. In order to use this function, the mixer should be in open position and the water diverter should be in the 'Massage' position. After pressing button F the display will show active hydromassage icon, the LED indicator next to the button will light up, the cursor will move to the activated icon, and "hydromassage" submenu will be shown on the display (at that moment none of the programmes are functioning yet). The following icons will be shown:

- 1) COMFORT 1
- 2) COMFORT 2
- 3) COMFORT 3
- 4) COMFORT 4
- 5) THERAPY 1
- 6) THERAPY 2
- 7) THERAPY 3



- 8) THERAPY 4
- 9) EXIT SETUP

Suitable programme can be activated by using buttons X/Y. Press OK button to start the massage programme. The display will simultaneously show massage speed (1 to 3) under functioning (activated) massage programme. Massage speed can be changed by using left/right buttons. Programme will always start at speed 2. Speed can be changed while the programme is activated. Speed cannot be saved. In order to stop activated massage programme:

- press OK button,
- press button F.

Display will stop showing "hydromassage" submenu if you:

- have not pressed any of the buttons within 20 seconds, provided that none of the massage programs are activated.
- use buttons X/Y to select exit setup icon and press OK button,
- switch massage function off by pressing button F,
- press button E, i.e. return to main menu.

2.6. SETUP

Icon on the display. No quick button!

Time setup

Open "setup" screen to set the time. Use buttons X/Y to select the setup icon shown on the display and press OK button, "setup" submenu will open. See the picture.

Use X/Y buttons to select time setup icon and then press OK button, the hour reading will start blinking. Blinking hour reading can be adjusted by using buttons X/Y. After setting the hour reading to desired number you may also set the minutes reading by pressing button P. Only the minute reading will start blinking after pressing button P. blinking minute reading can be adjusted by using buttons X/Y. In order to save the time set in blinking mode, press OK button. If the time has been in setup (blinking) mode for 20 seconds and no buttons have been pushed, the time will automatically restore to the settings used before entering into setup mode and display will stop showing "setup" screen.

Display will stop showing "setup" screen if you:

- have not pressed any of the buttons within 20 seconds,
- use buttons X/Y to select exit setup icon and press OK button.
- press button E, i.e. return to main menu

NB! Time always needs to be set after:

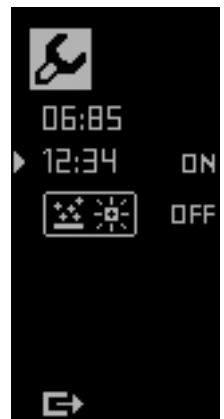

- connecting the product to the power network,
- power failure

The need to set the time is indicated by reading 00:00 on the display.

Setting timer for steam function

In order to set the timer, you need to open "setup" submenu. Use X/Y buttons to select setup icon shown on the display, press OK button and "setup" submenu will open. See the figure.

Use buttons X/Y to select steam function timer icon and press OK button, the hour reading of the timer will start to blink. The blinking reading shows the most recently set time. Blinking hour reading can be adjusted by using buttons X/Y. After setting the hour reading you may also set the minute reading by pressing button P. Only the minute reading will start to blink after pressing button P. The blinking minute reading can be adjusted at 5 minute intervals, by using buttons X/Y.

The icon shown on the timer row is either on or off (depending on whether the timer is switched on or off). In blinking mode the on/off icon can be changed by using buttons X/Y. Press OK button to switch the timer on, if there is icon "ON" behind the time reading. You can select on/off icon by pressing button P.

If the timer is switched on, the timer icon will be shown next to the steam function icon on the main screen and the timer icon will also be shown behind the time reading in standby mode.

NB! The user may, if so desired, use the steam before the time previously set for switching on the steam, but the preset automatic switch-on will be deactivated! If timer reading has been in the setup (blinking) mode for 20 seconds without pressing OK button, the timer setup will halt and display will stop showing "setup" submenu.

Display will stop showing "setup" submenu if you:

- have not pressed any of the buttons within 20 seconds,
- use buttons X/Y to select exit setup icon and press OK button.
- pressing button E, i.e. return to main menu.

NB!

a) Timer for steam function can be set maximum 24 hours in advance!

b) If the steam function is turned on by using timer setting and the temperature of 33° C is not achieved within 15 minutes, the steam function will be switched off!

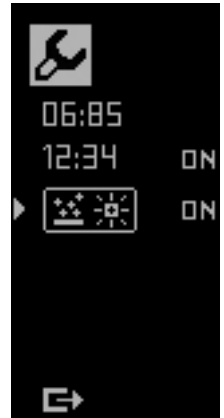

Setting the indication of achieving the selected temperature

In order to set the indication of achieving the selected temperature,

open "setup" submenu. Use buttons X/Y to select the setup icon shown on the display and press OK button, and "setup" submenu will open on the display. See the picture. Use buttons X/Y to select the icon of indication of achieving the selected temperature and press OK button, the on or off icon shown on the same row will start to blink (depending on whether the settings are switched on or off). In blinking mode the on/off icon can be changed by using buttons X/Y. Confirm the selection by pressing OK button.

If the on/off icon of achieving the selected temperature has been in the setup (blinking) mode for 20 seconds without pressing OK button, the setup will halt and return to previously set mode.

Display will stop showing "setup" screen if you:

- have not pressed any of the buttons within 20 seconds,
- use buttons X/Y to select exit setup icon and press OK button.
- press button E, i.e. return to main menu.

NB! Default (factory) settings have the indication of achieving selected temperature switched on. The indication of achieving the selected temperature resets to default (factory) settings after:

- connecting the product to power network,
- power failure

Steam generator service - SERV

The need for steam generator service is indicated by showing the SERV text on the display when switching on the steam function or when the function is active.

In order to service the steam generator, open "setup" submenu. For that purpose, use buttons X/Y to select the setup icon shown on the display and press OK button, which will open "setup" submenu. See the picture.

Use buttons X/Y to select steam generator service (SERV) icon and press OK button, the SERV icon on the display starts blinking and the steam generator is ready for service. Steam function is blocked and cannot be switched on. Then pour 500 ml of special service liquid in the generator through a corresponding orifice. Service cycle will last 3 hours and the SERV icon will be blinking on the display during the entire cycle. Steam generator service is completed, if the SERV icon is no longer shown on the display.

Display will stop showing "setup" submenu if you:

- have not pressed any of the buttons within 20 seconds,
- use buttons X/Y to select exit setup icon and press OK button,
- press button E, i.e. return to main menu.

NB! All the other functions beside steam function can be used when performing the service!



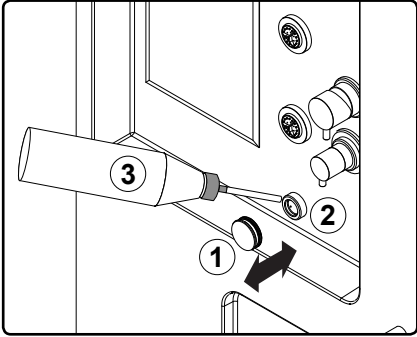

2.7. USING THE MIXER

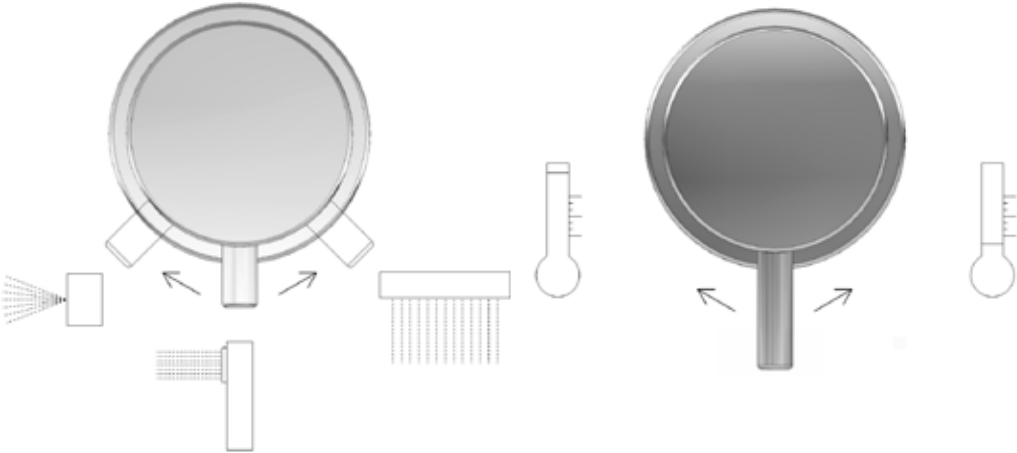

2.8. JETS

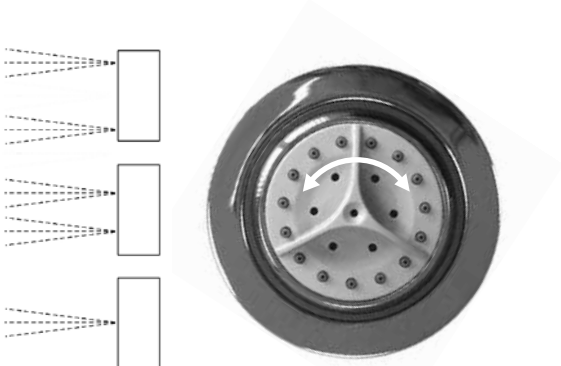

3. MAINTAINANCE

Xonyx™ solid surface baths and shower trays are finished with a silky surface finish. Xonyx™ is a very durable product that will last for years with simple care. Follow the recommendations below to properly clean Xonyx™ solid surface product.

3.1. EVERYDAY CARE

- It is recommended to clean the bathtub/shower cabin immediately after every use with thorough rinse of warm water and dry with soft and dry cloth to avoid water stains.
- Washing with soap or hand dishwashing liquid and water is usually sufficient to remove surface dirt or stains.
- Upon need of thorough cleaning wide variety of bath cleaning sprays sold with safety labelling allowing the cleaning of such surface or commercially available solid surface cleaners are effective.
- Drying is an important step, preventing a build-up of soap film or cleaning residue, which can create the appearance of light scratches over time.

3.2. PREVENTING DAMAGE

Some chemicals are not compatible with Solid Surface materials, and could permanently harm the surface beyond repair. Avoid surface contact with:

- Strong chlorinated solvents
- Chloroform
- Ketones
- Methylene chloride, acetone, turpentine (paint removers, nail polish remover)
- Very strong acids such as concentrated sulfuric and hydrochloric acids
- Acid drain cleaners, stove and toilet cleaning products should not be used
- Other unknown chemicals or chemicals not allowed for cleaning of Solid Surface materials

Surfaces exposed to these chemicals should be promptly flushed with water; contact may cause spots that may require extensive repairs. Remove nail polish with a non-acetone-based nail polish remover and flush with water.

- Avoid subjecting Xonyx™ Solid Surface to extreme hot temperatures or hot objects. Solid Surface has excellent heat resistant properties. However, placing heat-generating appliances or hot objects, can damage the surface.
- Avoid exposing Xonyx™ Solid Surface to strong chemicals listed above.
- Never cut on a Solid Surface surface to avoid scratching the surface.
- Avoid dropping heavy and/or sharp objects on the surface as it may harm the surface or altogether break the product beyond repair

3.3. DISINFECTING

Solid surface is not manufactured with any material that would promote the growth of any bacteria such as mold or mildew.

3.4. CLEANING OF DRAINAGE SYSTEM

The drainage system is assembled from standard plastic drain components. To remove a possible clog up a standard household drainage cleaning agent may be used that is allowed for such purpose. Remove the drain cover by turning it contra clockwise (baths) or pull it up/off (shower trays) and pour carefully the cleaning agent to the drain tube not spilling the pipe cleaner over product surfaces.

3.5. STEAM GENERATOR SERVICE

Look section 2.6, Steam generator service - SERV!

3.6. REPAIRS

For possible need of repair of the product please contact the dealer for further information. Minor damage that may accidentally occur is most often repairable.

3.7. LIMITED MANUFACTURERS' WARRANTY

- Limited Manufacturers' Warranty covers the product against concealed defects and/or other defects that appear only if the product has been used according to this installation manual.
- Limited Manufacturers Warranty is limited only to repairs and or replacement of defective parts and the Manufacturer does not accept any further liabilities of any kind beyond that.
- Limited Manufacturers' Warranty only applies if all shipping, storing, installation, operation and maintenance/cleaning conditions have been duly followed.
- Limited Manufacturers' Warranty covers only the replacement of the subparts suffering the defects and does not cover any shipping and/or replacement charges.
- Limited Manufacturers' Warranty does not cover normal wear of the unit upon intensive use or any damage to the unit or its sub-parts in result of improper and/or blatant use of the unit.
- Limited Manufacturers' Warranty for any parts in contact with water does not cover the defects and/or malfunction arising from water hardness, or impurity, or negligent cleaning problems.
- Limited Manufacturers' Warranty does not cover any indirect losses and/or loss of profits, nor does cover any indirect or related costs arising from the defect or malfunction of the unit.
- Gloss reduction, scratching, and staining on solid surfaces incurred over time due to use is NOT a manufacturing defect but is considered normal wear and tear – The forgoing is NOT covered under the Limited Warranty. However, the product can be re-sanded and repolished. For possible need of repair/repolish of the product please contact the dealer for further information.

P.S.Manufacturer reserves the right to change technical aspects on the products without prior notice.

4. TECHNICAL DATA

Electrical equipment

- Voltage: 230 V
- Frequency: 50 Hz
- Rated power: 3100 W
- Rated current: 13.5 A

- Frequency range: 76-108 Hz

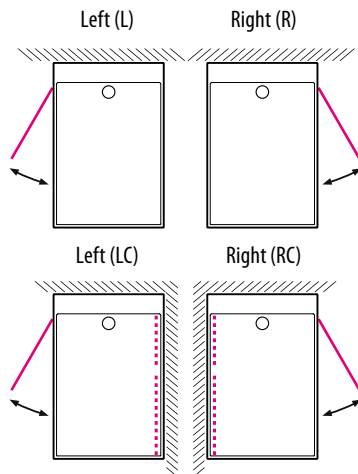
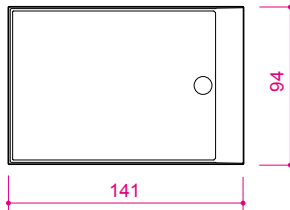
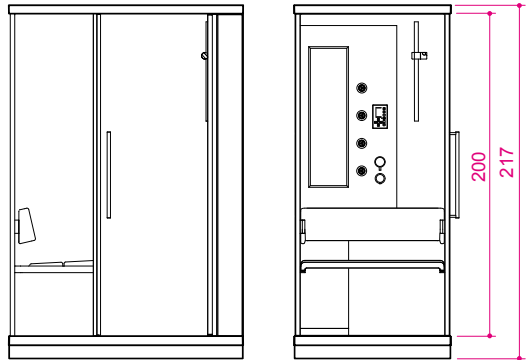

BALTECO
BATHROOMS

Balteco AS
Jälgimäe, Harjumaa 76401, Estonia
Phone: +372 6718 237, Fax: +372 6718 236
www.balteco.com