

VANNITOAD

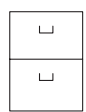

VANNID



MÖÖBEL



AURUSAUNAD



VALAMUD



KODUSPAA

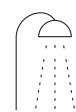

DUŠID



LISAD

BALTECO



SISUKORD

KIVIMASSIST VANNID, AURUSAUNAD	4	DUŠINURGAD, DUŠISEINAD	44
Azur 140, 155	5	Makro	45
Fiore	6	Line, High-Line, Extra-Line	46
Halo	7	Form	47
Gamma 150	8	Arc, Axis	48
Gamma 160	9	Mode, Sola	49
Flo	10	Fold	50
Dune	11	Vibe	51
Senzo	12	Detailid, duširuumi iste	52
Piano, Piano Hydro	13	Mio (dušipaneel)	53
Vero	14		
Mezzo	15	VANNITOAMÖÖBEL	54
Integra 170	16	Integra seeria	56
Integra 210	17	Piano seeria, Solid Surface	58
Vario	18	Piano seeria, valumarmor	60
Tetris	19	Willingen seeria	62
		Tripol seeria	64
AKRÜÜLIST MASSAAŽI- ja LIHTVANNID	20	Forte seeria, Piccante seeria	66
Juhtpaneelid Evo, Evo+	21	Peeclid	67
Massaažisüsteemid ja juhtpaneelid	22	Mööbli fassaadi värvivalik	68
Forma 150, 160, 170, 180	24		
Forma 190	25	VALAMUD	
Modul 150, 160, 170	26	Milo, Deco, Bowl, Cup	69
Modul 180	27		
Roma	28	XONYX TOOTED - TEHNILINE OSA	70
Loop	29	AKRÜÜLIST TOOTED - TEHNILINE OSA	74
Eclipse	30		
Idea	31		
Rhea	32		
Cali	33		
Orion	34		
Linea	35		
Metro	36		
Scala	37		
Quadrum	38		
Madonna	39		
Vannide dušiseinad	40		
Lisavarustus, puhastusvahendid	41		
Vannisegistid	42		
Kodune spaa – mugav ja privaatne	43		





KVALITEETSED JA EESTIS TOODETUD

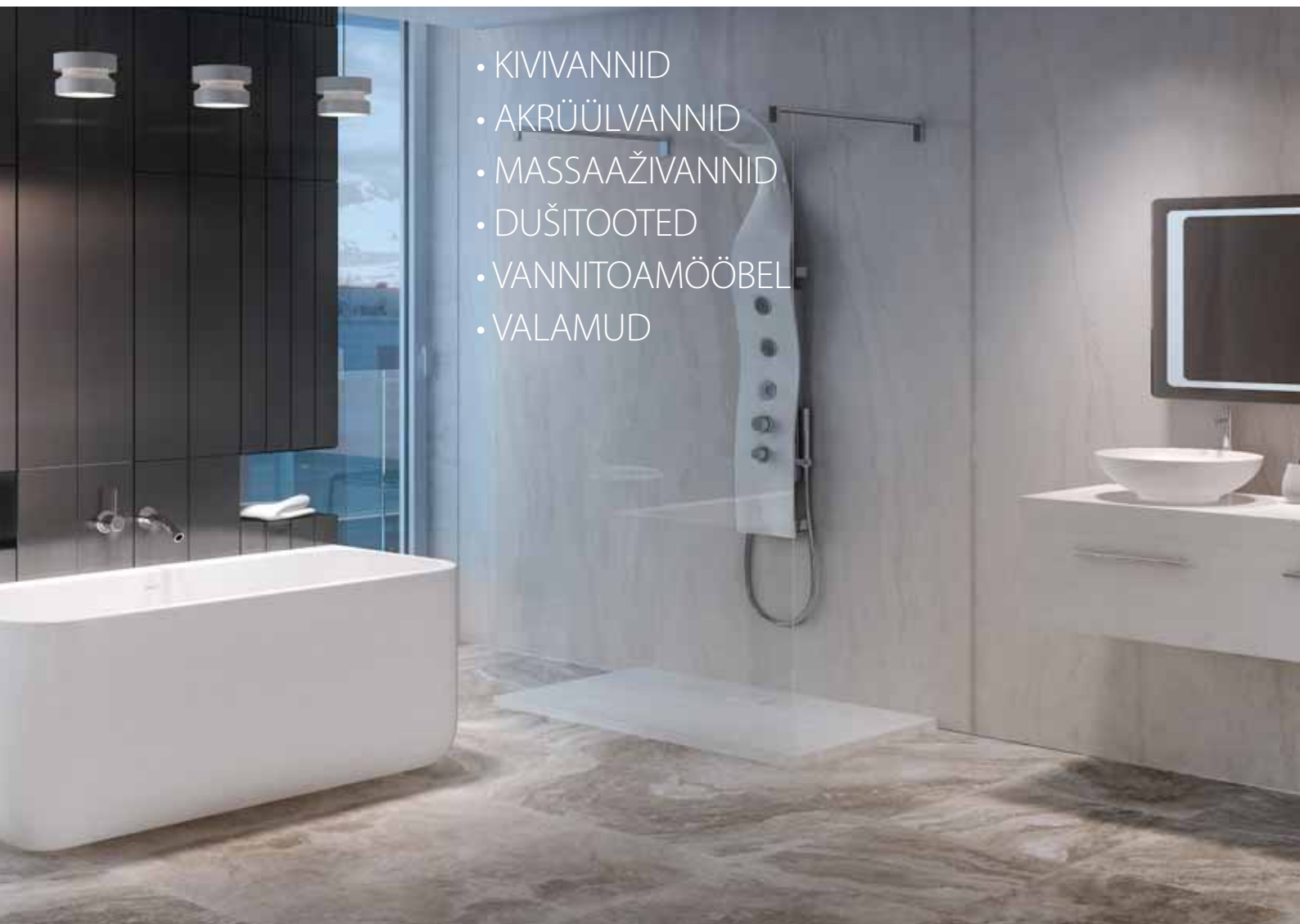

- KIVIVANNID
- AKRÜÜLVANNID
- MASSAAŽIVANNID
- DUŠITOOTED
- VANNITOAMÖÖBEL
- VALAMUD

Balteco loob ja toodab vannitoasisustust juba üle 25 aasta. Selle aja jooksul on Eesti kapitalil põhineva Põhja-Euroopa juhtiva liht- ja massaaživanne tootva ettevõtte tootevalik rikastunud dušiseinte, vannitoamööbli, aurusaunade ja Xonyx kivimassist disainvannidega.

Kliendi rahulolu, toodete kvaliteet ja vastupidavus on meile väga olulised. Seetõttu toodame Eestis, kasutame ainult kvaliteetseid materjale ja komponente. Balteco toodetega saab sisustada nii luksuslikke kui ka minimalistlikke vannitubasid, luues originaalseid lahendusi.

KIVIMASSIST VANNID, AURUSAUNAD

Xonyx™ sarja kivimassist valmistatud vannide, dušialuste, dušipaneelide ja aurusaunade loomisel on ühendatud moderne vormikeel ja innovaatiline Solid Surface tehnoloogia. Xonyx™ kivimass on väga vastupidav materjal. Toote tihe kasutamine ja puhastamine ei too kaasa pinnakihi kulumist, kuna materjalil puudub dekoorkiht. Xonyx™ kivimassist materjali pikk eluiga annab Balteco toodetele keskkonnasõbraliku iseloomu ja kõrge tarbimisväärtuse.



- **SOE JA SIIDINE PEALISPIND**

Xonyx'i lummuvalt siidine valge materjal on käega katsudes meeldivalt soe ja kehasõbralik.

- **MATERJALI PIKK ELUIGA**

Kivile sarnased omadused nagu: massiivsus, tugevus ja kulumiskindlus muudavad kivivannid kauakestvaks.

- **LIHTSALT PAIGALDATAV**

Balteco Xonyx kivivannid on paigaldatud tugevale toetusraamile, mis muudab paigaldamise lihtsaks.

- **KESKKONNASÕBRALIK MATERJAL**

Tänu Xonyx materjali vastupidavusele ja kestvusele on tegu väärtusliku keskkonnasõbraliku materjaliga.

- **XONYX KATESTUS ÄRAVOOLUL**

Vannide äravooluavade katted on kaetud Xonyx kivimassiga.



AZUR 140, 155



XONYX™

KIVIVANN

- Mõõdud: 140 x 70 x 61 cm
- Veemaht (max): 215 l
- Kaal (ilma veeta): 90 kg
- Mõõdud: 154 x 70 x 63 cm
- Veemaht (max): 240 l
- Kaal (ilma veeta): 99 kg

XONYX KIVIMASSIST VANN:

- Massiivne ja tugev korpus
- Vanni korpus ja paneel ühes tükis
- Reguleeritavate jalgadega toetusraam
- Üles/alla avanev/sulguv äravool Xonyx massist dekoratiivkattega
- Varustatud ülevooluavaga

AZUR 140

- Lihtvann kivimassist: **1770.-**
- Värvitud paneeliga vann: **2235.-**

AZUR 155

- Lihtvann kivimassist: **1890.-**
- Värvitud paneeliga vann: **2355.-**

PS. Võimalik valida paneeli värv RAL koodi alusel.

Tehnilised andmed lk 70



UUS!

FIORE

XONYX™

KIVIVANN

- Mõõdud: 160 x 72 x 61 cm
- Veemaht (max): 210 l
- Kaal (ilma veeta): 92 kg

XONYX KIVIMASSIST VANN:

- Massiivne ja tugev korpus
- Vanni korpus ja paneel ühes tükis
- Reguleeritavate jalgadega toetusraam
- Üles/alla avanev/sulguv äravool Xonyx massist dekoratiivkattega
- Varustatud ülevooluavaga

- Lihtvann kivimassist: **1940.-**

- Värvitud paneeliga vann: **2405.-**

PS. Võimalik valida paneeli värv RAL koodi alusel.

Tehnilised andmed lk 70



UUS!

HALO

XONYX™

KIVIVANN

- Mõõdud: 170 x 72 x 63 cm
- Veemaht (max): 250 l
- Kaal (ilma veeta): 110 kg

XONYX KIVIMASSIST VANN:

- Massiivne ja tugev korpus
- Vanni korpus ja paneel ühes tükis
- Reguleeritavate jalgadega toetusraam
- Üles/alla avanev/sulguv äravool Xonyx massist dekoratiivkattega
- Varustatud ülevooluavaga

- Lihtvann kivimassist: **2010.-**

- Värvitud paneeliga vann: **2475.-**

PS. Võimalik valida paneeli värv RAL koodi alusel.

Tehnilised andmed lk 70



GAMMA 150



XONYX™

KIVIVANN

- Mõõdud: 150 x 62/85 x 65 cm
- Veemaht (max): 240 l
- Kaal (ilma veeta): 91 kg

XONYX KIVIMASSIST VANN:

- Massiivne ja tugev korpus
- Vanni korpus ja paneel ühes tükis
- Reguleeritavate jalgadega toetusraam
- Üles/alla avanev/sulguv äravool Xonyx massist dekoratiivkattega
- Varustatud ülevooluavaga

- Lihtvann kivimassist: **1975.-**

- Värvitud paneeliga vann: **2440.-**

- Ainult paremakäeline vann.

PS. Võimalik valida paneeli värv RAL koodi alusel.

Tehnilised andmed lk 70



GAMMA 160



XONYX™

KIVIVANN

- Mõõdud: 160 x 71 x 62 cm
- Veemaht (max): 260 l
- Kaal (ilma veeta): 95 kg

XONYX KIVIMASSIST VANN:

- Massiivne ja tugev korpus
- Vanni korpus ja paneel ühes tükis
- Reguleeritavate jalgadega toetusraam
- Üles/alla avanev/sulguv äravool Xonyx massist dekoratiivkattega
- Varustatud ülevooluvaga

- Lihtvann kivimassist: **2020.-**

- Värvitud paneeliga vann: **2485.-**

PS. Võimalik valida paneeli värv RAL koodi alusel.

Tehnilised andmed lk 70



FLO SEINALIIDESGA

FLO

XONYX™

KIVIVANN

- Mõõdud: 169 x 84 x 63 cm
- Veemaht (max): 240 l
- Kaal (ilma veeta): 107 kg

XONYX KIVIMASSIST VANN:

- Massiivne ja tugev korpus
- Vanni korpus ja paneel ühes tükis
- Reguleeritavate jalgadega toetusraam
- Üles/alla avanev/sulguv äravool Xonyx massist dekoratiivkattega
- Varustatud ülevooluavaga

- Lihtvann kivimassist: **2010.-**

- Lihtvann seinaliidesega: **2225.-**

- Seinaliidesese küljekattepaneelid (kompl.): **105.-**

Tehnilised andmed lk 70



DUNE



DUNE SEINALIIDESGA



DUNE NURGALIIDESEGA

XONYX™

KIVIVANN

- Mõõdud: 174 x 77 x 63 cm
- Veemaht (max): 260 l
- Kaal (ilma veeta): 104 kg

XONYX KIVIMASSIST VANN:

- Massiivne ja tugev korpus
- Vanni korpus ja paneel ühes tükis
- Reguleeritavate jalgadega toetusraam
- Üles/alla avanev/sulguv äravool Xonyx massist dekoratiivkattega
- Varustatud ülevooluavaga

- Lihtvann kivimassist: **2100.-**
- Lihtvann seinaliidesega: **2315.-**
- Lihtvann nurgaliidesega: **2315.-**
- Sein- ja/või nurgaliidese küljekattepaneelid (kompl.): **105.-**

Tehnilised andmed lk 70



SENZO

XONYX™

KIVIVANN

- Mõõdud: 178 x 88 x 65 cm
- Veemaht (max): 280 l
- Kaal (ilma veeta): 125 kg

XONYX KIVIMASSIST VANN:

- Massiivne ja tugev korpus
- Vanni korpus ja paneel ühes tükis
- Reguleeritavate jalgadega toetusraam
- Üles/alla avanev/sulguv äravool Xonyx massist dekoratiivkattega
- Varustatud ülevooluavaga

- Lihtvann kivimassist: **2295.-**

- Värvitud paneeliga vann: **2760.-**

PS. Võimalik valida paneeli värv RAL koodi alusel.

Tehnilised andmed lk 70



LIHTVANN



VEEMASSAAŽIVANN

PIANO



XONYX™

KIVIVANN

- Mõõdud: 171 x 101/65 x 67 cm
- Veemaht (max): 290 l
- Kaal (ilma veeta): 75 kg

XONYX KIVIMASSIST VANN:

- Massiivne ja tugev korpus
- Vanni korpus on valmistatud kivimassist ja vanni paneel komposiitmaterjalist
- Saadaval nii parema- kui vasakukäelisena

- Lihtvann kivimassist: **1600.-**

- SlimLine Hydro veemassaaživann: **2870.-**

P.S. Vanni paneeli värvid: must/valge (läikiv).

- Vanni esipaneel on komposiitmaterjalist. Tellides vanni ilma esipaneelita, lahuta hinnast 200.-

Tehnilised andmed lk 70



VERO

XONYX™

KIVIVANN

- Mõõdud: 167 x 74 x 62/67 cm
- Veemaht (max): 230 l
- Kaal (ilma veeta): 99 kg

XONYX KIVIMASSIST VANN:

- Massiivne ja tugev korpus
- Vanni korpus ja paneel ühes tükis
- Reguleeritavate jalgadega toetusraam
- Üles/alla avanev/sulguv äravool Xonyx massist dekoratiivkattega
- Varustatud ülevooluavaga

- Lihtvann kivimassist: **1875.-**

- Värvitud paneeliga vann: **2340.-**

PS. Võimalik valida paneeli värv RAL koodi alusel.

Tehnilised andmed lk 70



MEZZO



XONYX™

KIVIVANN

- Mõõdud: 182 x 86 x 64/80 cm
- Veemaht (max): 250 l
- Kaal (ilma veeta): 133 kg

XONYX KIVIMASSIST VANN:

- Massiivne ja tugev korpus
- Vanni korpus ja paneel ühes tükis
- Reguleeritavate jalgadega toetusraam
- Üles/alla avanev/sulguv äravool Xonyx massist dekoratiivkattega
- Varustatud ülevooluavaga

- Lihtvann kivimassist: **2375.-**

Tehnilised andmed lk 70



INTEGRA

170

XONYX™

INTEGREERITUD KIVIVANN

- Mõõdud: 170 x 80 x 61 cm
- Veemaht (max): 260 l
- Kaal (ilma veeta): 96 kg

XONYX KIVIMASSIST VANN:

- Massiivne ja tugev korpus
- Reguleeritavate jalgadega toetusraam
- Üles/alla avanev/sulguv äravool on kaetud Xonyx kivimassiga
- Varustatud ülevooluavaga
- Komplektis üks MDF-ist otsa- ja esipaneel (kaetud PVC-dekoratiivkilega).

- Lihtvann kivimassist: **2110.-**

- Täiendav otsapaneel: **105.-**

Tehnilised andmed lk 70



INTEGRA

210

XONYX™

INTEGREERITUD KIVIVANN

- Mõõdud: 209 x 80 x 61 cm
- Veemaht (max): 260 l
- Kaal (ilma veeta): 141 kg

XONYX KIVIMASSIST VANN:

- Massiivne ja tugev korpus
- Reguleeritavate jalgadega toetusraam
- Üles/alla avanev/sulguv äravool on kaetud Xonyx kivimassiga
- Varustatud ülevooluavaga
- Komplektis üks MDF-ist otsa- ja esipaneel (kaetud PVC-dekoratiivkilega).
- Esipaneeli on integreeritud 2 sahtlit.

- Lihtvann kivimassist: **3235.-**

- Täiendav otsapaneel: **105.-**

Tehnilised andmed lk 70



VARIO

DUŠIKABIIN+AURUSAUN+MASSAAŽIVANN

- Minimalistlik, funktsionaalne
- "Kolm ühes" toode
- Mõõdud: 168 x 79 x 218 cm / 240 l

S4: Dušikabiin+aurusaun+massaaživann	6745.-
S1: Dušikabiin+aurusaun+lihtvann	5900.-
S0: Dušikabiin+lihtvann	4395.-
Puidust lisaiste	190.-
Puidust lisa seljatugi+kinnitused	240.-

XONYX™

Tehnilised andmed ja tellimisinfo lk 73





TETRIS

DUŠIKABIIN-AURUSAUN

- Luksuslikult avar, kahekohaline
- Uue põlvkonna aurusaun
- Vabaltseisvalt paigaldatav

• Mõõdud: 94 x 141 x 217 cm

S4: Dušikabiin+aurusaun 6375.-

S4: Ilma klaasist otsaseina katteta 6090.-

Tehnilised andmed ja tellimisinfo lk 73

XONYX™



AKRÜÜLIST MASSAAŽIVANNID, LIHTVANNID

MASSAAŽIVANN

LIHTVANN



- **OPTIMAALNE VANNI SÜGAVUS 48-51cm**

Optimaalne vanni sügavus on oluline eelis madala sügavusega vannide ees.

- **KÕRGEKVALITEEDILINE SANITEETNE AKRÜÜL**

Euroopa suurima tehase Altuglas (Prantsusmaa) valmistatud tippkvaliteediga materjal.

- **VANNI JÄIKUSE TAGAB RUUMILINE RAAM**

Reguleeritavate jalgadega raam tagab vanni jäikuse pikaajalisel kasutamisel.

- **AKRÜÜLI POLYCORE™ EKSTRATUGEVDUS**

Mitmekihiline akrüülvanni tugevdus tagab vannide jäikuse ja vastupidavuse aastateks.

- **ELEKTROONILISED JUHTIMISPANEELID**

Töökindlad ja funktsionaalsed Evo/Evo Plus puldid ja Easy-Touch nupud.

- **TÕHUSAD JA TÖÖKINDLAD MASSAAŽISEADMED**

Võimsad veemassaažipumbad (900-1500 W) tagavad efektiivse massaaži.

- **MASSAAŽI INTENSIIVSUSE SUJUV REGULEERIMINE**

Õhu reguleerimiskruvid võimaldavad muuta üldise veemassaaži, seljamassaaži (ABM™) ja jalamassaaži intensiivsust.

- **VAIKSE TÖÖREIIMIGA ÕHU-MASSAAŽIPUHURID**

Massaaživannidele monteeritakse kõrge töökindlusega õhumassaažipuhurid (500 W).

- **VEETASEME ANDURID TAGAVAD OHUTUSE**

Kõigile Balteco massaaživannidele paigaldatakse veetaseme andurid, mis välistavad tühja vanni korral pumpade ja/või halogeenvalgustuse sisselülitumise.

- **EKSKLUSIIVSUS DETAILIDES**

Kõigil vette jäävatel detailidel - düüsidel, veevõtjatel ja üle-äravooludel on kvaliteetne kroonitud messingist katevus.

- **UNIKAALNE SEERIANUMBER**

Kõik Balteco lihtvannid ja massaaživannid läbivad põhjaliku kvaliteedikontrolli ja testimise ning varustatakse unikaalse seerianumbriga.

- **TESTITUD KVALITEET**

Kõik Balteco tooted vastavad Euroopas kehtivatele ohutus- ja kvaliteedinõuetele. Tootmine vastab ISO9001 nõuetele. Testimispartner on Semko (Rootsi).

EVO JUHTIMISPULT

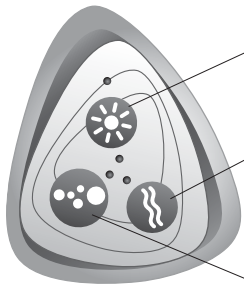

1. Valgustuse sisse/väljalülitamine.
Valgustuse ajal põleb indikaator.
2. Kromoterapia juhtimine.

Veemassaaži sisse ja väljalülitamine.
Veemassaaž töötab järjest 30 min ja lülitab ennast siis välja.

Õhumassaaži sisse ja väljalülitamine.
Õhumassaaž töötab järjest 30 min ja lülitab ennast siis välja.

EVO+ JUHTIMISPULT

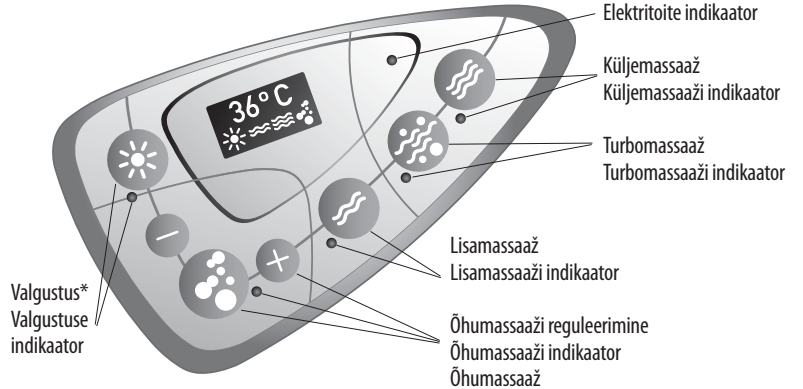

Valgustus*
Valgustuse
indikaator

* Halogeen või kromoterapia,
olenevalt vanni modifikatsioonist

Elektritoite indikaator

Küljemassaaž
Küljemassaaži indikaator

Turbomassaaž
Turbomassaaži indikaator

Lisamassaaž
Lisamassaaži indikaator

Õhumassaaži reguleerimine
Õhumassaaži indikaator
Õhumassaaž

SLIMLINE HYDRO

STANDARDVARUSTUS



Veemassaaži
külje- ja
jaladüüsid



Veemassaaži
seljadüüside
lisavõimsus



Veemassaaži
küljedüüside
lisavõimsus



Veemassaaži
jaladüüside
lisavõimsus

LISAVARUSTUS



Veealune
valgustus
AmbiLight



Elektroniline
vanni veega
täitmine



PANEELID **PANEL+**



PANEL+
PANEEL



TAVALINE
PANEEL

Eesmärgiga tagada akrüülist disainvannide maksimaalselt esteetiline välimus ja puhtus detailides pakub Balteco PANEL+ paneelilahenduse juures enam kui ükski teine Euroopa tootja.





































PANEL+ paneelilahenduse eelised:

① L-kujulised akrüülist paneelid
on ilma nurgaliidesteta













② Paneelide **otsad on pööratud**
(ilma silmatorkavate otsalõigeteta)

③ **Kruvivabad magnetkinnitused**
tagavad paneeli vaate täieliku puhtuse.

MASSAAŽISÜSTEEMID JA JUHTPANEELID

	S1 LIHTVANN	S3 HYDRO	S4 COMBI	S6 HYDROLUX PLUS
Juhtimine				
Standardvarustus		<ul style="list-style-type: none"> Veemassaaž  900-1100 W Standardised džiüsid  Extra Safety Assurance  Adjustable Back Massage  	<ul style="list-style-type: none"> Õhumassaaž  500 W Veemassaaž  900-1100 W Standardised džiüsid  Extra Safety Assurance  Adjustable Back Massage  	<ul style="list-style-type: none"> Veemassaaž (2 pumpa)  1500 W  1100 W Halogeenvalgustus  SlimLine džiüsid  Extra Safety Assurance  Adjustable Back Massage  Dual Hydromassage Power 
Lisavarustus	<ul style="list-style-type: none"> Halogeenvalgustus  Kromoterapia  AmbiLight  AutoFill  	<ul style="list-style-type: none"> Halogeenvalgustus  Kromoterapia  AmbiLight  AutoFill  	<ul style="list-style-type: none"> Halogeenvalgustus  Kromoterapia  AmbiLight  AutoFill  Meh. turbomassaaž  	<ul style="list-style-type: none"> Kromoterapia  AmbiLight  AutoFill 
Süsteemi kirjeldus	<p>Lihtvann. Saniteetselt kvaliteetkrüülist vann koos esipaneeli(de)ga, mis on paigaldatud reguleeritavate jalgadega alumiiniumraamile ja varustatud ära- ja ülevooluga.</p>	<p>Veemassaaži vann. Veemassaaž toimub läbi vanni külgedel olevate džiüside. Massaaži tugevus on reguleeritav vanni äärelle paigutatud õhukruvidega. Süsteem sisaldab reguleeritava intensiivsusega seljamassaaži süsteemi (ABM™) ja jalamassaažipaketti.</p>	<p>Õhu- ja veemassaaži vann. Õhumassaaž toimub vanni põhja-džiüside kaudu. Veemassaaž toimub läbi vanni külgedel olevate džiüside. Massaaži tugevus on reguleeritav vanni äärelle paigutatud õhukruvidega. Süsteem sisaldab reguleeritava intensiivsusega seljamassaaži süsteemi (ABM™) ja jalamassaažipaketti.</p>	<p>Veemassaaži vann (kaks pumpa). Veemassaaž toimub küljedžiüside ja seljadžiüside kaudu. Kahte pumpa on võimalik eraldi juhtida. Massaaži tugevus on reguleeritav vanni äärelle paigutatud õhukruvide kaudu. Süsteem sisaldab kahte reguleeritava intensiivsusega seljamassaažisüsteemi (ABM™) või selja- ja jalamassaažipaketti.</p>

MASSAAŽISÜSTEEMID JA JUHTPANEELID

	S7 COMBILUX	S8 COMBILUX PLUS	S10 EXCLUSIVE PLUS	S11 SLIMLINE HYDRO
Juhtimine				
Standardvarustus	<ul style="list-style-type: none"> Õhumassaaž  Veemassaaž  Halogeenvalgustus Automaatne läbipuhumine SlimLine düüsid Extra Safety Assurance Adjustable Back Massage 	<ul style="list-style-type: none"> Õhumassaaž  Veemassaaž (2 pumpa)   Halogeenvalgustus Automaatne läbipuhumine SlimLine düüsid Extra Safety Assurance Adjustable Back Massage Dual Hydromassage Power 	<ul style="list-style-type: none"> Õhumassaaž  Veemassaaž (2 pumpa)   Kromoterapia Automaatne läbipuhumine SlimLine düüsid Extra Safety Assurance Adjustable Back Massage Dual Hydromassage Power Electronic Turbo Massage 	<ul style="list-style-type: none"> Veemassaaž  Therapy programm SlimLine düüsid Extra Safety Assurance Adjustable Back Massage
Lisavarustus	<ul style="list-style-type: none"> Kromoterapia AmbiLight AutoFill Meh. turbomassaaž 	<ul style="list-style-type: none"> Kromoterapia AmbiLight AutoFill Meh. turbomassaaž 	<ul style="list-style-type: none"> AmbiLight AutoFill 	<ul style="list-style-type: none"> AmbiLight AutoFill
Süsteemi kirjeldus	<p>Õhu- ja veemassaaži vann. Elektrooniliselt reguleeritava tugevusega õhumassaaž toimub vanni põhjadüüside kaudu. Veemassaaž toimub vanni külgedesse paigaldatud düüside kaudu. Massaaži tugevus on reguleeritav õhukruvide kaudu. Süsteem sisaldab reguleeritava intensiivsusega seljamassaaži süsteemi (ABM™) ja jalamassaažipaketti.</p>	<p>Õhu- ja veemassaaži vann (kaks pumpa). Elektrooniliselt reguleeritava tugevusega õhumassaaž toimub vanni põhjadüüside kaudu. Veemassaaž toimub vanni külgedesse paigaldatud düüside kaudu. Massaaži tugevus on reguleeritav õhukruvide kaudu. Süsteem sisaldab kahe reguleeritava intensiivsusega seljamassaažisüsteemi (ABM™) või selja- ja jalamassaažipaketti.</p>	<p>Õhu- ja veemassaaži vann (kaks pumpa). Elektrooniliselt reguleeritava tugevusega õhumassaaž toimub vanni põhjadüüside kaudu. Veemassaaž toimub vanni külgedesse paigaldatud düüside kaudu. Massaaži tugevus on reguleeritav õhukruvide kaudu. Süsteem sisaldab kahe reguleeritava intensiivsusega seljamassaažisüsteemi (ABM™) või selja- ja jalamassaažipaketti. Veemassaaži survet saab maksimiseerida elektroonilise turbomassaaži (ETM™) abil.</p>	<p>SlimLine veemassaaži vann. SlimLine Hydro põhineb täisintegreeritud elektroonilisel massaažifunktsioonide juhtimisel. Erinevaid massaažipiirkondi (külj, selg, jalad) ja veealust valgustust saab juhtida lihtsa nupuvajutusega EasyTouch paneelil. SlimLine juhtimisüsteemi EasyTouch juhtimisnupud on kasutajamugavust silmas pidades paigutatud vanni siseküljele.</p>



FORMA

150; 160; 170; 180

acrylic



SIRGJOONELINE AKRÜÜLVANN

150 • Mõõdud: **150x70x61 cm**
• Veemaht (max): 190 l

160 • Mõõdud: **160x70x62 cm**
• Veemaht (max): 210 l

170 • Mõõdud: **170x75x64 cm**
• Veemaht (max): 265 l

180 • Mõõdud: **180x80x65 cm**
• Veemaht (max): 300 l

PANEELID

Ilma paneelideta vann - E 12

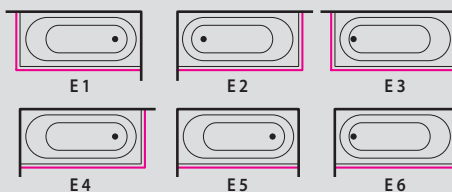

- Forma 170 on võimalik komplekteerida turvaklaasist dušiseinaga (170x155cm) - lk 40
- Forma kõiki vanne on võimalik komplekteerida turvaklaasist dušisirmiga (86x150cm) - lk 40
- Segistid ja lisavarustus lk 41, tehniline info lk 74
- Vanni hind sisaldab esipaneeli. Tellides vanni ilma esipaneelita, lahuta hinnast 67.-

Massaažisüsteem / Vann	150	160	170	180
LIHTVANN (S1)	535.-	565.-	595.-	680.-
Hydro (S3)	1450.-	1495.-	1530.-	1605.-
Combi (S4)	1840.-	1870.-	1900.-	1985.-
HydroLux Plus (S6)	-	-	-	-
CombiLux (S7)	2240.-	2380.-	2435.-	2520.-
CombiLux Plus (S8)	-	-	-	-
Exclusive Plus (S10)	-	-	-	-
SlimLine Hydro (S11)	2035.-	2105.-	2135.-	2210.-



FORMA

190



acrylic

PANEL+

SIRGJOONELINE AKRÜÜLVANN

- Mõõdud: **190x86x66 cm**
- Veemaht (max): 330 l

PANEELID

Ilma paneelideta vann - E 24

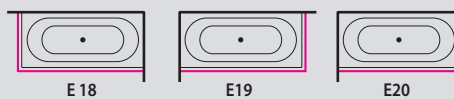

• Vanni on võimalik komplekteerida turvaklaasist dušiseinaga (86x150 cm) - lk 40

• Segistid ja lisavarustus lk 41, tehniline info lk 74

• Vanni hind sisaldab esipaneeli. Tellides vanni ilma esipaneelita, lahuta hinnast 67.-

Massaažisüsteem / Vann **Forma 190**

LIHTVANN (S1) 955.-

Hydro (S3) 1750.-

Combi (S4) 2140.-

HydroLux Plus (S6) 2930.-

CombiLux (S7) 2990.-

CombiLux Plus (S8) 3460.-

Exclusive Plus (S10) 3935.-

SlimLine Hydro (S11) 2365.-



MODUL

150; 160; 170

acrylic

PANEL+

SIRGJONELINE AKRÜÜLVANN

150 • Mõõdud: **150x70x63 cm**
• Veemaht (max): 205 l

160 • Mõõdud: **160x70x64 cm**
• Veemaht (max): 230 l

170 • Mõõdud: **170x75x66 cm**
• Veemaht (max): 260 l

PANEELID

Ilma paneelideta vann - E 12

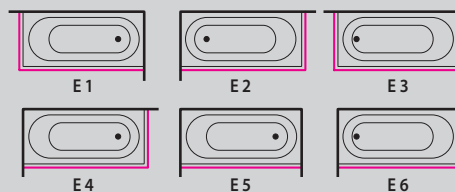

• Modul vanne on võimalik komplekteerida: turvaklaasist dušiseinaga (86x150cm) - lk 40

• Segistid ja lisavarustus lk 41, tehniline info lk 74

• Vanni hind sisaldab esipaneeli. Tellides vanni ilma esipaneelita, lahuta hinnast 67.-

Massaažisüsteem / Vann	150	160	170
LIHTVANN (S1)	535.-	565.-	595.-
Hydro (S3)	1450.-	1495.-	1530.-
Combi (S4)	1840.-	1870.-	1900.-
HydroLux Plus (S6)	-	-	-
CombiLux (S7)	2240.-	2380.-	2435.-
CombiLux Plus (S8)	-	-	-
Exclusive Plus (S10)	-	-	-
SlimLine Hydro (S11)	2035.-	2105.-	2135.-



MODUL 180

acrylic

PANEL+

SIRGJONELINE AKRÜÜLVANN

- Mõõdud: **179x80x67 cm**
- Veemaht (max): 250 l

PANEELID

Ilma paneelideta vann - E 24

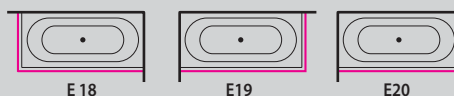

• Modul 18 vann on võimalik komplekteerida turvaklaasist dušiseinaga (86x150 cm) - lk 40

• Segistid ja lisavarustus lk 41, tehniline info lk 74

• Vanni hind sisaldab esipaneeli. Tellides vanni ilma esipaneelita, lahuta hinnast 67.-

Massaažisüsteem / Vann **Modul 180**

LIHTVANN (S1) 680.-

Hydro (S3) 1605.-

Combi (S4) 1985.-

HydroLux Plus (S6) 2615.-

CombiLux (S7) 2520.-

CombiLux Plus (S8) 3125.-

Exclusive Plus (S10) -

SlimLine Hydro (S11) 2210.-



ROMA

acrylic

PANEL+

SIRGJOONELINE AKRÜÜLVANN

- Mõõdud: **179x80x67 cm**
- Veemaht (max): 235 l

PANEELID

Ilma paneelideta vann - E 24

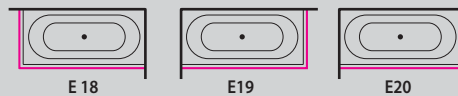

• Roma vanni on võimalik komplekteerida: turvaklaasist dušiseinaga (86x150cm) - lk 40

• Segistid ja lisavarustus lk 41, tehniline info lk 74

• Vanni hind sisaldab esipaneeli. Tellides vanni ilma esipaneelita, lahuta hinnast 67.-

.....
 Massaažisüsteem / Vann **Roma**

LIHTVANN (S1) 750.-

Hydro (S3) 1710.-

Combi (S4) 2090.-

HydroLux Plus (S6) 2980.-

CombiLux (S7) 2890.-

CombiLux Plus (S8) 3485.-

Exclusive Plus (S10) -

SlimLine Hydro (S11) 2335.-



LOOP

acrylic

PANEL+

SIRGJONELINE AKRÜÜLVANN

- Mõõdud: **189x89x67 cm**
- Veemaht (max): 300 l

PANEELID

Ilma paneelideta vann - E 24

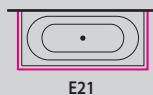
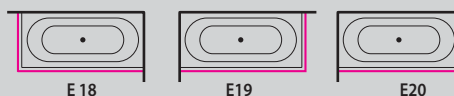

• Segistid ja lisavarustus lk 41, tehniline info lk 74

• Vanni hind sisaldab esipaneeli. Tellides vanni ilma esipaneelita: lahuta hinnast (pikk) 45.- ja/või (lühike) 20.-

Massaažisüsteem / Vann **Loop**

LIHTVANN (S1) 955.-

Hydro (S3) 1750.-

Combi (S4) 2140.-

HydroLux Plus (S6) 2930.-

CombiLux (S7) 2990.-

CombiLux Plus (S8) 3460.-

Exclusive Plus (S10) 3935.-

SlimLine Hydro (S11) 2365.-



ECLIPSE

150; 160; 170



acrylic

PANEL+

TILGAKUJULINE AKRÜÜLVANN

150 • Mõõdud: **150x95x63 cm**
• Veemaht (max): 220 l

160 • Mõõdud: **160x95x65 cm**
• Veemaht (max): 240 l

170 • Mõõdud: **169x97x65 cm**
• Veemaht (max): 280 l

PANEELID

Ilma paneelideta vann - E 12

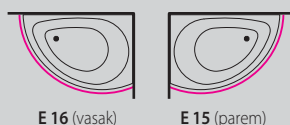

• Eclipse vann on võimalik komplekteerida toonitud turvaklaasist dušiseinaga - lk 40

• Segistid ja lisavarustus lk 41, tehniline info lk 74

• Vanni hind sisaldab esipaneeli. Tellides vanni ilma esipaneelita, lahuta hinnast 67.-

Massaažisüsteem / Vann	150	160	170
LIHTVANN (S1)	615.-	690.-	720.-
Hydro (S3)	1495.-	1545.-	1640.-
Combi (S4)	1870.-	1930.-	2025.-
HydroLux Plus (S6)	-	-	-
CombiLux (S7)	2610.-	2690.-	2770.-
CombiLux Plus (S8)	-	-	-
Exclusive Plus (S10)	-	-	-
SlimLine Hydro (S11)	2105.-	2170.-	2255.-



IDEA

150; 160; 170

acrylic

PANEL+

TILGAKUJULINE AKRÜÜLVANN

150 • Mõõdud: **150x91x64 cm**
• Veemaht (max): 180 l

160 • Mõõdud: **160x92x65 cm**
• Veemaht (max): 205 l

170 • Mõõdud: **170x100x65 cm**
• Veemaht (max): 235 l

PANEELID

Ilma paneelideta vann - E 12

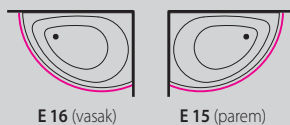

• Idea vanne on võimalik komplekteerida toonitud turvaklaasist dušiseinaga - lk 40

• Segistid ja lisavarustus lk 41, tehniline info lk 74

• Vanni hind sisaldab esipaneeli. Tellides vanni ilma esipaneelita, lahuta hinnast 67,-

Massaažisüsteem / Vann	150	160	170
LIHTVANN (S1)	615.-	690.-	720.-
Hydro (S3)	1495.-	1545.-	1640.-
Combi (S4)	1870.-	1930.-	2025.-
HydroLux Plus (S6)	-	-	-
CombiLux (S7)	2610.-	2690.-	2770.-
CombiLux Plus (S8)	-	-	-
Exclusive Plus (S10)	-	-	-
SlimLine Hydro (S11)	2105.-	2170.-	2255.-



RHEA

150; 160; 170

acrylic



PANEL+

TILGAKUJULINE AKRÜÜLVANN

150 • Mõõdud: **149x100x63 cm**
• Veemaht (max): 230 l

160 • Mõõdud: **160x100x67 cm**
• Veemaht (max): 300 l

170 • Mõõdud: **169x118x69 cm**
• Veemaht (max): 335 l

PANEELID

Ilma paneelideta vann - E 12

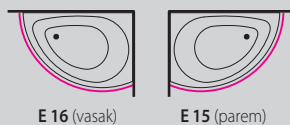

• Rhea 15/16 on võimalik komplekteerida toonitud turvakraasist dušiseinaga. Dušiseinaga vannile ei saa paigaldada pakutud segisteid - lk 40

• Segistid ja lisavarustus lk 41, tehniline info lk 74

• Vanni hind sisaldab esipaneeli. Tellides vanni ilma esipaneelita, lahuta hinnast 67.-

Massaažisüsteem / Vann	150	160	170
LIHTVANN (S1)	615.-	690.-	720.-
Hydro (S3)	1495.-	1545.-	1640.-
Combi (S4)	1870.-	1930.-	2025.-
HydroLux Plus (S6)	-	-	-
CombiLux (S7)	2610.-	2690.-	2770.-
CombiLux Plus (S8)	-	-	-
Exclusive Plus (S10)	-	-	-
SlimLine Hydro (S11)	2105.-	2170.-	2255.-



CALI

acrylic



PANEL+

TILGAKUJULINE AKRÜÜLVANN

- Mõõdud: **170x117x66 cm**
- Veemaht (max): 380 l

PANEELID

Ilma paneelideta vann - E 12



• Segistid ja lisavarustus lk 41, tehniline info lk 74

• Vanni hind sisaldab esipaneeli. Tellides vanni ilma esipaneelita, lahuta hinnast 67.-

Massaažisüsteem / Vann	Cali
LIHTVANN (S1)	895.-
Hydro (S3)	1745.-
Combi (S4)	2140.-
HydroLux Plus (S6)	3135.-
CombiLux (S7)	2935.-
CombiLux Plus (S8)	3675.-
Exclusive Plus (S10)	4150.-
SlimLine Hydro (S11)	2365.-

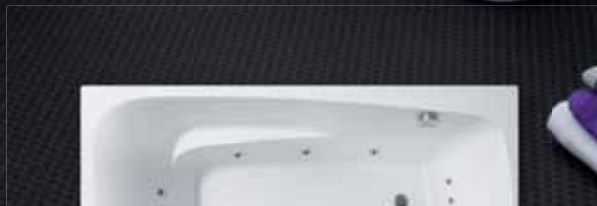

ORION

acrylic



PANEL+

TILGAKUJULINE AKRÜÜLVANN

- Mõõdud: **169x102x66 cm**
- Veemaht (max): 300 l

PANEELID

Ilma paneelideta vann - E 12

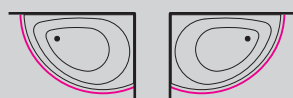

E 16 (vasak)

E 15 (parem)

• Segistid ja lisavarustus lk 41, tehniline info lk 74

• Vanni hind sisaldab esipaneeli. Tellides vanni ilma esipaneelita, lahuta hinnast 67.-

Massaažisüsteem / Vann	Orion
LIHTVANN (S1)	815.-
Hydro (S3)	1645.-
Combi (S4)	2025.-
HydroLux Plus (S6)	2960.-
CombiLux (S7)	2830.-
CombiLux Plus (S8)	3430.-
Exclusive Plus (S10)	-
SlimLine Hydro (S11)	2255.-



LINEA

140; 150



acrylic

PANEL+

AKRÜÜLIST NURGAVANN

140 • Mõõdud: **140x140x68 cm**
• Veemaht (max): 280 l

150 • Mõõdud: **150x150x69 cm**
• Veemaht (max): 330 l

PANEELID

Ilma paneelideta vann - E 12

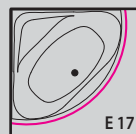

• Linea vann on võimalik komplekteerida toonitud turvaklaasist dušiseinaga - lk 40

• Segistid ja lisavarustus lk 41, tehniline info lk 74

• Vanni hind sisaldab esipaneeli. Tellides vanni ilma esipaneelita, lahuta hinnast 67,-

Massaažisüsteem / Vann **Linea 140** **Linea 150**

LIHTVANN (S1) 710.- 740.-

Hydro (S3) 1590.- 1655.-

Combi (S4) 1975.- 2040.-

HydroLux Plus (S6) 2765.- 2835.-

CombiLux (S7) 2705.- 2780.-

CombiLux Plus (S8) 3295.- 3340.-

Exclusive Plus (S10) 3765.- 3850.-

SlimLine Hydro (S11) 2210.- 2275.-



METRO

acrylic

PANEL+

AKRÜÜLIST NURGAVANN

- Mõõdud: **155x155x64 cm**
- Veemaht (max): 430 l

PANEELID

Ilma paneelideta vann - E 12

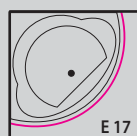

• Segistid ja lisavarustus lk 41, tehniline info lk 74

• Vanni hind sisaldab esipaneeli. Tellides vanni ilma esipaneelita, lahuta hinnast 67.-

Massaažisüsteem / Vann	Metro
LIHTVANN (S1)	915.-
Hydro (S3)	1710.-
Combi (S4)	2100.-
HydroLux Plus (S6)	2810.-
CombiLux (S7)	2785.-
CombiLux Plus (S8)	3380.-
Exclusive Plus (S10)	3850.-
SlimLine Hydro (S11)	-



SCALA

acrylic

PANEL+

AKRÜÜLVANN KAHELE

- Mõõdud: **180x120x67 cm**
- Veemaht (max): 535 l

PANEELID

Ilma paneelideta vann - E 24

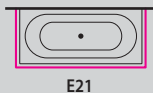
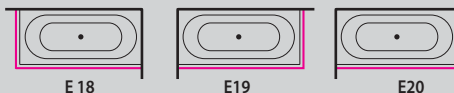

• Segistid ja lisavarustus lk 41, tehniline info lk 74

• Vanni hind sisaldab esipaneeli. Tellides vanni ilma esipaneelita: lahuta hinnast (pikk) 45.- ja/või (lühike) 20.-

Massaažisüsteem / Vann **Scala**

LIHTVANN (S1) 1045.-

Hydro (S3) 2010.-

Combi (S4) 2540.-

HydroLux Plus (S6) 3440.-

CombiLux (S7) 3020.-

CombiLux Plus (S8) 4060.-

Exclusive Plus (S10) -

SlimLine Hydro (S11) -



QUADRUM

acrylic

AKRÜÜLVANN

- Mõõdud: **178x178x72 cm**
- Veemaht (max): 600 l

PANEELID

Tegemist on ilma paneelideta vanniga, ehk uputatava vanniga.

• Segistid ja lisavarustus lk 41, tehniline info lk 74

.....
 Massaažisüsteem / Vann **Quadrum**

LIHTVANN (S1) 1205.-

Hydro (S3) -

Combi (S4) -

HydroLux Plus (S6) 3765.-

CombiLux (S7) -

CombiLux Plus (S8) 4255.-

Exclusive Plus (S10) -

SlimLine Hydro (S11) -



MADONNA

acrylic

AKRÜÜLVANN

- Mõõdud: Ø 173 x 75 cm
- Veemaht (max): 475 l

PANEELID

Ilma paneelideta vann - E 24

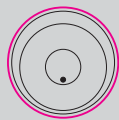

E 26

• Segistid ja lisavarustus lk 41, tehniline info lk 74

• Vanni hind sisaldab esipaneeli. Tellides vanni ilma esipaneelita, lahuta hinnast 256.-

.....
 Massaažisüsteem / Vann **Madonna**

LIHTVANN (S1) 1765.-

Hydro (S3) -

Combi (S4) -

HydroLux Plus (S6) 3545.-

CombiLux (S7) 3830.-

CombiLux Plus (S8) 4185.-

Exclusive Plus (S10) 4655.-

SlimLine Hydro (S11) -

.....

DUŠISEINAD VANNIDELE



ECLIPSE



RHEA

DUŠISEIN VANNIDELE ECLIPSE 15, 16, 17

Dušiseina kõrgus: 155 cm. Vajalik min. ruumi kõrgus: 225 cm

Dušisein koosneb liikumatust seinaklaasist ja liuguksest. Dušisein on toodetud 6 mm toonitud (T2) karastatud klaasidest, alumiinium profiilidest ja otsapostist millesse on integreeritud: dušisegisti, vihmadušš, vanni täitmistila, käepide.

Hind (ECL/VES): 1295.-

DUŠISEIN VANNIDELE RHEA 15, 16

Dušiseina kõrgus: 153 cm. Vajalik min. ruumi kõrgus: 220 cm.

Rhea 15 ja 16 vannile pakutav statsionaarne toonitud (T2) karastatud klaasist dušisein paigaldatakse vanni kitsamasse otsa. Dušiseina kinnitusprofiili värvitoon on metallik.

Hind (RHE/VES): 345.-



LINEA



IDEA

DUŠISEIN VANNIDELE LINEA 14, 15 ja IDEA 15, 16, 17

Dušiseina kõrgus: 153 cm. Vajalik min. ruumi kõrgus: 225 cm

Linea/Idea dušisein koosneb liikumatust seinaklaasist ja avanevast/sulguvast liuguksest. Dušisein on toodetud 6 mm toonitud (T2) karastatud klaasidest ja alumiinium profiilidest.

Hind (LI4/VES): 710.- (LI5/VES): 745.-
Hind (IDE5/VES): 615.- (IDE6/VES): 640.- (IDE7/VES): 675.-

DUŠISEIN SIRGJOONELISTELE VANNIDELE

Dušiseina mõõdud: 86 x 150 cm

Sobib vannidele:

- Forma 15, 16, 17, 18, 19
- Modul 15, 16, 17, 18
- Roma

Dušisein on toodetud 6 mm karastatud klaasist ja anodeeritud alumiinium profiilist. Dušisein on latthingel, mis võimaldab seina vanni servalt soovitud suunas pöörata.

Hind (VS1/T1): 185.- (VS1/T2): 185.-

DUŠISEIN VANNILE FORMA 17

Dušiseina kõrgus: 155 cm. Vajalik min. ruumi kõrgus: 225 cm

Forma 17 dušiesisein on toodetud läbipaistvast T1 või toonitud T2 turvaklaasist ja alumiiniumprofiilidest. Koosneb liuguksest ja liikumatutest otsa- ja külgeinast. Käeliskus: vastavalt vanni paneelide asetusele.

Hind:

Kirgas klaas (kood: A1 NURKA/T1): 740.-
Kirgas klaas (kood: A2 NIŠŠI/T1): 580.-
Toonklaas (kood: B1 NURKA/T2): 840.-
Toonklaas (kood: B2 NIŠŠI/T2): 660.-



SIRGJOONELINE



FORMA

LISAVARUSTUS

Kromoteraapiline valgustus

(kood: KLA*) 380.-
Kromoteraapilist valgustust saab tellida süsteemidele S1, S3, S4.

Halogeenvalgustus

(kood: LA) 215.-
Halogeenvalgustust saab tellida süsteemidele S1, S3, S4.

AmbiLight veealune valgustus

(kood: AL) 325.-
AmbiLight sisaldub süsteemides: S6, S10.
Saab tellida süsteemidele: S1, S3, S4 ja S11.



Autofill

(kood: AF)145.-
Mugavusfunktsioon: katkestab vanni täitmisel veevoolu segistist ja annab sellest helisignaali märku. Pole vaja kontrollida vanni veetaset täitmise ajal.
Saab tellida lisaks kõikidele massaaži-süsteemidele koos segistitega

Vanni ülevoolust täitmine

(kood: OS) 95.-
Ülevoolust täitmist saab paigaldada kõikidele Balteco vannitüüpidele.
Võimalik paigaldada segisti Christina C1Z1 ja C1 juurde.

Mehaaniline turbomassaaž

(kood: W)180.-
S4, S7 ja S8 süsteemi korral suunatakse puhuri võimsus veemassaažisüsteemi ja saadakse eriti tugev veemassaaž.

PUHASTUSVAHENDID



Xonyx pindade puhastusvahend 650 ml

- Efektiivne puhastusvahend
- Meeldiva lõhnaga
- Ei sisalda toksilisi jääke
- Keskkonnasõbralik

(kood: PX) 7,90.-

Akrüülipindade puhastusvahend 650 ml

- Efektiivne puhastusvahend
- Meeldiva lõhnaga
- Ei sisalda toksilisi jääke
- Keskkonnasõbralik

(kood: PA) 5,90.-

Klaaspindade puhastusvahend 650 ml

- Efektiivne puhastusvahend
- Meeldiva lõhnaga
- Ei sisalda toksilisi jääke
- Keskkonnasõbralik

(kood: PK) 5,90.-

Torustiku desinfitseeriv puhasti PipeCleaner 250 ml

- Desinfitseeriv puhastusvahend
- Meeldiva lõhnaga
- Ei sisalda toksilisi jääke
- Keskkonnasõbralik

(kood: PC) 5,90.-

VANNISEGISTID

CHRISTINA (kood C1)
295.-



CHRISTINA (kood C2)
365.-



CHRISTINA (kood C1Z1)
Koos uputatud dušikäpaga
315.-



CHRISTINA (kood C2Z1)
Koos uputatud dušikäpaga
385.-



DAMIXA CLOVER (kood DC)
567.-



ALPI (kood A3)
395.-



DAMIXA JUPITER (kood DJ1)
515.-



KODUNE SPAA – MUGAV JA PRIVAATNE

Veemassaaž ühendab endas vee ja massaaži toime. Organismi mõjutab samal ajal nii vee temperatuur, kui ka vee surve kehapiinnale.

Tõhusal veemassaažil on abiks vee soojusjuhtivus, mis on 23 korda suurem kui õhul. Organism on veetemperatuuri muutusele tundlikum, reageerides sellele kiiremini kui samale õhutemperatuuri muutusele.

Veemassaaž sobib nii tööst või treeningust põhjustatud lihaspingete leevendamiseks, tervislikuks lõõgastumiseks, kui ka paljude haiguste lisaraviks.



Soojas vannis tõuseb pulsi- ja hingamissagedus, langeb vererõhk ja lihaspinge. Intensiivse soojusvahetusega kaasneb kiirem ainevahetus ja higistamine.

Massaaž võimendab veeprotseduuri toimet, avaldades survet erinevatele kehapiirkondadele.

Vanniprotseduuri ajal väheneb koos lihastoonusega ka koormus liigestele. Tänu seljalihaste lõdvestumisele pikeneb lülisammas 5-6 %.

Veres alaneb vähemalt 3 stressireaktsiooniga seostatava hormooni tase – vannis käimine ja veemassaaž on väga tõhusa stressi vähendava toimega.

Mõõdukalt sooja (34-37 °C) vannivee juures alaneb kasutaja pulsisagedus keskmiselt 6-10 löögi võrra minutis. Veresooned laienevad, vererõhk langeb ja verevarustus paraneb.

Pikki protseduure võib teha vees temperatuuril, mis vastab ligikaudu inimese kehatemperatuurile.



DUŠITOOTED

- Uudsed lahendused
- Kvaliteetne furnituur
- Euroopa materjalid
- Eestis valmistatud



MAKRO

DUŠINURK (alus+kabiin): **90x120 cm; 90x140 cm**

WALK-IN DUŠINURK (alus+sirm): **160x200 cm; 180x200 cm**

MAKRO DUŠIALUS	MADAL	KÕRGE
	45 mm	135 mm
Dušialus 90 x 120 cm	560.-	705.-
Dušialus 90 x 140 cm	610.-	755.-
Dušialus 90 x 160 cm	660.-	-
Dušialus 90 x 180 cm	710.-	-

MAKRO DUŠINURK

8 mm karastatud kirgas klaas; läikiv alumiiniumprofiil

Dušinurk 90 x 120 x 200 cm	875.-
Dušinurk 90 x 140 x 200 cm	905.-

WALK-IN DUŠISIRM

10 mm karastatud kirgas klaas; läikivast roostevabast terasest furnituur

Dušisirm 160 x 200 cm	535.-
Dušisirm 180 x 200 cm	585.-



MAKRO 140 dušinurk (madal)

DUŠIALUS

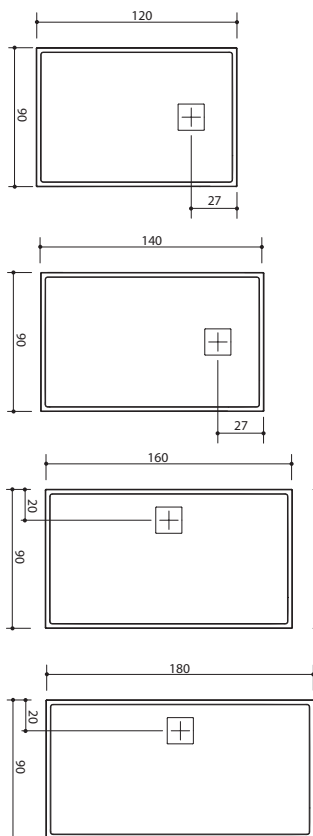

DUŠINURK (ALUSEGA)

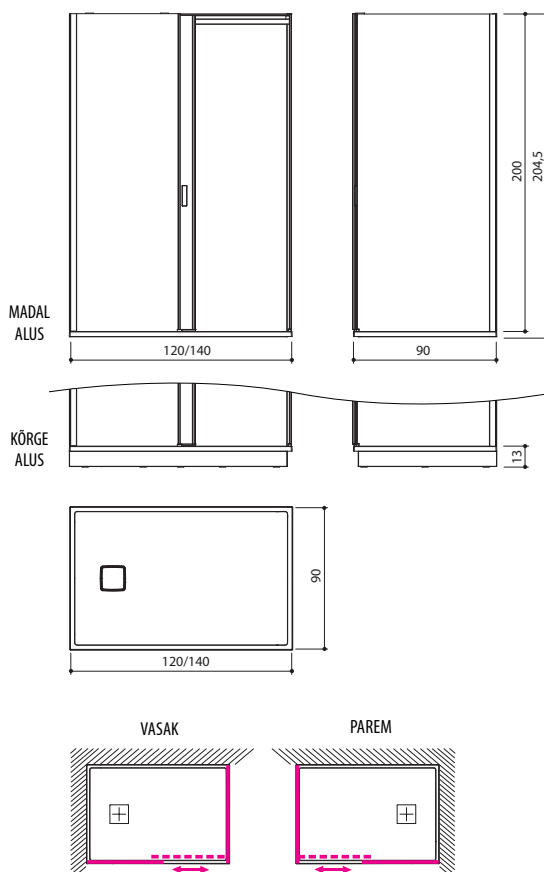

WALK-IN DUŠISIRM (ALUSEGA)

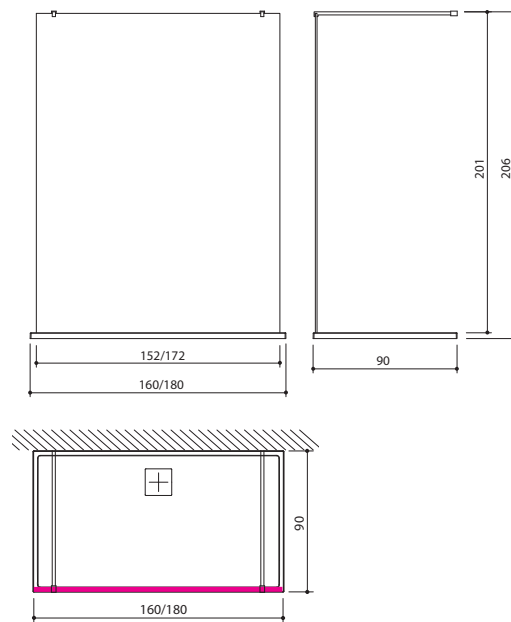

LINE HIGH-LINE EXTRA-LINE

- Praktiline fikseeritud dušisein (FSS2, FSS3, FSS4) eraldamaks dušiala või kaitsmaks mööblit.
- Saadaval eri kõrgusega: LINE 190 cm, HIGH-LINE 225 cm või vabalt valitud kõrgusega EXTRA-LINE.
- Saadaval nii standardlaiusena kui erimõõdus valitud laiusena.

TOODE KOOSNEB:

LINE: 190 cm dušisein, 6 mm karastatud sirge klaas (kirkas), alumiiniumprofiil (anodeeritud/läikiv), ülemine klaasitugi KT, alumine klaasikinnitus (U-profiil), kinnitustarvikud.

HIGH-LINE: 225 cm dušisein, 6 mm karastatud sirge klaas (kirkas, üle 65 cm erimõõt 8 mm), alumiiniumprofiil (anodeeritud/läikiv), ülemine klaasitugi KT, alumine klaasikinnitus (U-profiil), kinnitustarvikud.

EXTRA-LINE: 200-250 cm erimõõdus laiusena dušisein, 8 mm karastatud sirge klaas (kirkas), alumiiniumprofiil (anodeeritud/läikiv), ülemine klaasitugi KT, alumine klaasikinnitus (U-profiil), kinnitustarvikud.

PAIGUTUS:

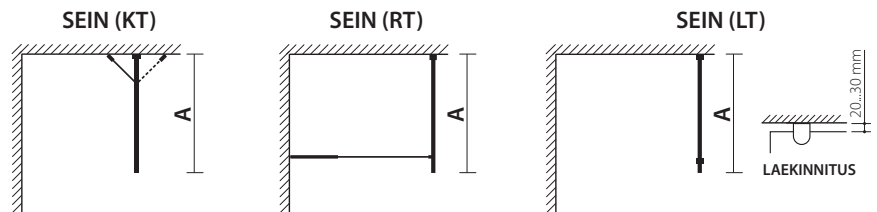

LINE 45

HINNAD JA TEHNILINE INFO:

Kood*	Toote kirjeldus	Mõõt A (sein)	Hind PrA (anod. profiil)	Hind PrG (läikiv profiil)
FSS2/35/FT1/Prx	35 cm fikseeritud dušisein LINE	35 cm	165.-	190.-
FSS2/45/FT1/Prx	45 cm fikseeritud dušisein LINE	45 cm	170.-	195.-
FSS2/55/FT1/Prx	55 cm fikseeritud dušisein LINE	55 cm	175.-	200.-
FSS2/65/FT1/Prx	65 cm fikseeritud dušisein LINE	65 cm	180.-	205.-
FSS2/X/FT1/Prx	ERIMÕÖT (35-64 cm) fikseeritud dušisein LINE	–	235.-	260.-
FSS2/X/FT1/Prx	ERIMÕÖT (65-100 cm) fikseeritud dušisein LINE	–	255.-	280.-
FSS3/55/FT1/Prx	55 cm fikseeritud dušisein HIGH-LINE	55 cm	180.-	–
FSS3/65/FT1/Prx	65 cm fikseeritud dušisein HIGH-LINE	65 cm	195.-	–
FSS3/X/FT1/Prx	ERIMÕÖT (35-64 cm) fikseeritud dušisein HIGH-LINE	–	255.-	–
FSS3/X/FT1/Prx	ERIMÕÖT (65-100 cm) fikseeritud dušisein HIGH-LINE	–	295.-	–
FSS4/X+Y/FT1/Prx	ERIMÕÖT (laius: 65-120 cm, kõrgus: 200-250 cm) fikseeritud dušisein EXTRA-LINE**	–	345.-	–

* Muutuv parameeter koodis: Prx – profiili tüüp; X – toote laius; Y – toote kõrgus

** Laekinnitiga klaasi ülalt kinnitamise puhul peab klaasi ülemine serv olema laest 20...30 mm kaugusel.

LISAVARUSTUS:

RT	Seina risttugi RT	59.-
LT6	Laetugi LT 6 mm klaasile	25.-
LT8	Laetugi LT 8 mm klaasile	25.-

FORM

- 200 cm kõrgune pendeluksest (PSS1) ja fikseeritud seinast (FSS1) koosnev dušinurk (tellida eraldi).
- Võimalik kasutada ka üksiku ukseksena või üksiku dušiseinana.
- Fikseeritud sein kinnitub põrandale U-profiiliga, seina jäikuse tagab risttugi.
- Saadaval nii standardlaiusena kui erimõõdus valitud laiusga.
- Kõik paigutusvariatsioonid lubavad toodet paigaldada ka vastandkäälisena.

TOODE KOOSNEB:

Pendeluks (PSS1): 200 cm pendeluks, 6 mm karastatud sirge klaas (kirkas/toonitud), alumiiniumprofiil (anodeeritud/läikiv), käepide, ukse magnetihend, alumine veeti-hend, kinnitustarvikud

Fikseeritud sein (FSS1): 200 cm dušisein, 6 mm karastatud sirge klaas (kirkas/tooni-tud), alumiiniumprofiil (anodeeritud/läikiv), ülemine klaasi risttugi RT, alumine klaas-ikinnitus (U-profiil), ukse magnetihend, kinnitustarvikud.

PAIGUTUS:

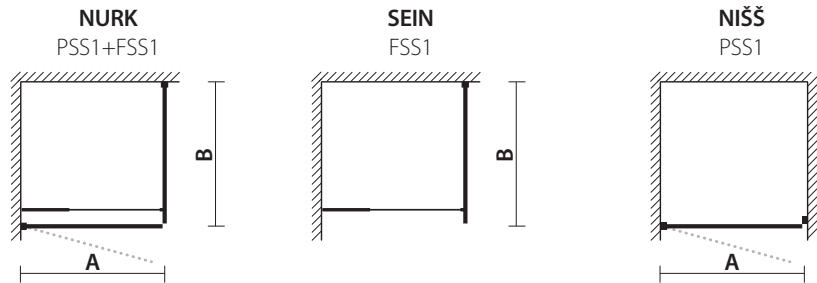

FORM (nurk)

HINNAD JA TEHNILINE INFO:

Kood*	Toote kirjeldus	Ava mõõt*** A (nišš)	Toote mõõt B (sein)	Toote mõõt A (nurk) B (nurk)	Hind FT1 (kirkas)	Hind FT2 (toonitud)
PSS1/80/FTx/PrA	80 cm sirge pendeluks, anodeeritud profiil	780 mm	78 cm	80 cm	225.-	250.-
PSS1/80/FTx/PrG	80 cm sirge pendeluks, läikiv profiil	780 mm	78 cm	80 cm	250.-	275.-
PSS1/90/FTx/PrA	90 cm sirge pendeluks, anodeeritud profiil	880 mm	88 cm	90 cm	235.-	260.-
PSS1/90/FTx/PrG	90 cm sirge pendeluks, läikiv profiil	880 mm	88 cm	90 cm	260.-	285.-
PSS1/X/FTx/PrA	ERIMÕÖT (70-95 cm) sirge pendeluks, anod. profiil	X	–	X+2 cm	330.-	355.-
PSS1/X/FTx/PrG	ERIMÕÖT (70-95 cm) sirge pendeluks, läikiv profiil	X	–	X+2 cm	355.-	380.-
FSS1/80/FTx/PrA	80 cm fikseeritud sein, anodeeritud profiil	–	78 cm	80 cm	230.-	255.-
FSS1/80/FTx/PrG	80 cm fikseeritud sein, läikiv profiil	–	78 cm	80 cm	255.-	280.-
FSS1/90/FTx/PrA	90 cm fikseeritud sein, anodeeritud profiil	–	88 cm	90 cm	235.-	260.-
FSS1/90/FTx/PrG	90 cm fikseeritud sein, läikiv profiil	–	88 cm	90 cm	260.-	285.-
FSS1/X/FTx/PrA	ERIMÕÖT (40-69 cm) fikseeritud sein, anod. profiil**	–	X	X+2 cm	320.-	345.-
FSS1/X/FTx/PrG	ERIMÕÖT (40-69 cm) fikseeritud sein, läikiv profiil**	–	X	X+2 cm	345.-	370.-
FSS1/X/FTx/PrA	ERIMÕÖT (70-95 cm) fikseeritud sein, anod. profiil**	–	X	X+2 cm	330.-	355.-
FSS1/X/FTx/PrG	ERIMÕÖT (70-95 cm) fikseeritud sein, läikiv profiil**	–	X	X+2 cm	355.-	380.-

* Muutuv parameeter koodis: FTx – klaasi tüüp; X – toote laius, mm

** Niššiasetuse korral mõõta avaus kolmest kohast (alt, keskest, ülevalt)

*** Niššiasetuse korral veenduda, et toote paigaldustolerants ± 5 mm on piisav

LISAVARUSTUS:

VPM1	Vastandprofiil magnetiga (asetus nišši)	55.-
KT	Seina kaldtugi KT	39.-

FORM (sein)

ARC

- Kumerate 190 cm kõrguste pendelustega dušinurk (PNK2).

TOODE KOOSNEB:

190 cm pendelüks (2x), 6 mm karastatud kumer klaas (kirkas/toonitud), alumiiniumprofiil (anodeeritud/läikiv), käepide (2x), ukse magnetihend (2x), alumine veetihend (2x), kinnitustarvikud

PAIGUTUS: NURK

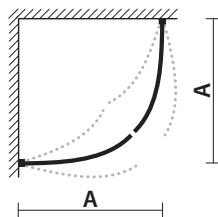

HINNAD JA TEHNILINE INFO:

Kood*	Toote kirjeldus	Mõõt A (nurk)	Hind FT1 (kirkas)	Hind FT2 (toonitud)
PNK2/80/FTx/PrA	80x80 cm kumer dušinurk ARC, anodeeritud profiil	80 cm	445.-	470.-
PNK2/80/FTx/PrG	80x80 cm kumer dušinurk ARC, läikiv profiil	80 cm	495.-	520.-
PNK2/90/FTx/PrA	90x90 cm kumer dušinurk ARC, anodeeritud profiil	90 cm	460.-	485.-
PNK2/90/FTx/PrG	90x90 cm kumer dušinurk ARC, läikiv profiil	90 cm	510.-	535.-

* Muutuv parameeter koodis: FTx - klaasi tüüp



AXIS

- Kumera klaasiga 190 cm kõrgune üksik pendelüks (PSK3).
- Ilma käepideme ja ukse magnetihendita pendelüks.
- Toodet saab paigaldada ka vastandkäälsena.

TOODE KOOSNEB:

190 cm pendelüks, 6 mm karastatud kumer klaas (kirkas/toonitud), alumiiniumprofiil (anodeeritud/läikiv), alumine veetihend, kinnitustarvikud

PAIGUTUS: UKS

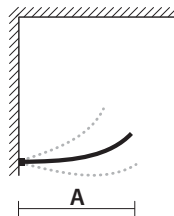

HINNAD JA TEHNILINE INFO:

Kood*	Toote kirjeldus	Mõõt A (uks)	Hind FT1 (kirkas)	Hind FT2 (toonitud)
PSK3/63/FTx/PrA	63 cm kumer pendelüks AXIS, anodeeritud profiil	63 cm	220.-	230.-
PSK3/63/FTx/PrG	63 cm kumer pendelüks AXIS, läikiv profiil	63 cm	245.-	255.-
PSK3/73/FTx/PrA	73 cm kumer pendelüks AXIS, anodeeritud profiil	73 cm	230.-	240.-
PSK3/73/FTx/PrG	73 cm kumer pendelüks AXIS, läikiv profiil	73 cm	255.-	265.-

* Muutuv parameeter koodis: FTx - klaasi tüüp



MODE

- Universaalne 190 cm kõrgune pendeluks (PSS2) erinevate paigaldusvõimalustega - üksiku ukseks või dušinurgaks paigutatuna.
- Dušinurk eeldab kahe ukse valmistist - kokku saab kombineerida eri mõõdus ukse.
- Dušinurk on kombineeritav ka tootega FOLD.
- Saadaval nii standardlaiusena kui erimõõdus valitud laiusena.

TOODE KOOSNEB: 190 cm pendeluks, 6 mm karastatud sirge klaas (kirkas/toonitud), alumiiniumprofiil (anodeeritud/läikiv), käepide, ukse magnetihend, alumine veetihend, kinnitustarvikud

PAIGUTUS:

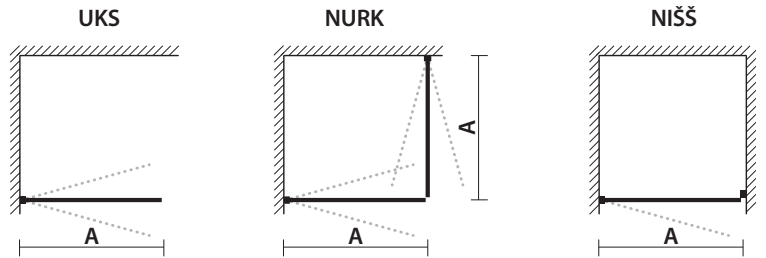

HINNAD JA TEHNILINE INFO:

Kood*	Toote kirjeldus	Ava mõõt*** A (nišš)	Toote mõõt A (uks)	Toote mõõt A (nurk)	Hind FT1 (kirkas)	Hind FT2 (toonitud)
PSS2/70/FTx/PrA	70 cm sirge pendeluks MODE, anodeeritud profiil	680 mm	68 cm	70 cm	200.-	210.-
PSS2/70/FTx/PrG	70 cm sirge pendeluks MODE, läikiv profiil	680 mm	68 cm	70 cm	225.-	235.-
PSS2/80/FTx/PrA	80 cm sirge pendeluks MODE, anodeeritud profiil	780 mm	78 cm	80 cm	205.-	215.-
PSS2/80/FTx/PrG	80 cm sirge pendeluks MODE, läikiv profiil	780 mm	78 cm	80 cm	230.-	240.-
PSS2/90/FTx/PrA	90 cm sirge pendeluks MODE, anodeeritud profiil	880 mm	88 cm	90 cm	210.-	220.-
PSS2/90/FTx/PrG	90 cm sirge pendeluks MODE, läikiv profiil	880 mm	88 cm	90 cm	235.-	245.-
PSS2/X/FTx/PrA	ERIMÕÖT (60-95 cm) sirge pendeluks MODE, anod. profiil**	X	X	X+2 cm	325.-	350.-
PSS2/X/FTx/PrG	ERIMÕÖT (60-95 cm) sirge pendeluks MODE, läikiv profiil**	X	X	X+2 cm	350.-	375.-

* Muutuva parameeter koodis: FTx - klaasi tüüp; X - toote laius, mm

** Niššiasetuse korral mõõta avaus kolmest kohast (alt, keskest, ülevalt)

*** Niššiasetuse korral veenduda, et toote paigaldustolerants ± 5 mm on piisav

LISAVARUSTUS:

VPM2 Vastandprofiil magnetiga (asetus nišši) 55.-

SOLA

- Sirge klaasiga 190 cm kõrgune üksik pendeluks (PSS3)
- Ilma käepideme ja ukse magnetihendita pendeluks.
- Saadaval nii standardlaiusena kui erimõõdus valitud laiusena.

TOODE KOOSNEB:

190 cm pendeluks, 6 mm karastatud sirge klaas (kirkas/toonitud), alumiiniumprofiil (anodeeritud/läikiv), alumine veetihend, kinnitustarvikud

HINNAD JA TEHNILINE INFO:

Kood*	Toote kirjeldus	Mõõt A (uks)	Hind FT1 (kirkas)	Hind FT2 (toonitud)
PSS3/70/FTx/PrA	70 cm sirge pendeluks SOLA, anodeeritud profiil	68 cm	180.-	190.-
PSS3/70/FTx/PrG	70 cm sirge pendeluks SOLA, läikiv profiil	68 cm	205.-	215.-
PSS3/80/FTx/PrA	80 cm sirge pendeluks SOLA, anodeeritud profiil	78 cm	190.-	200.-
PSS3/80/FTx/PrG	80 cm sirge pendeluks SOLA, läikiv profiil	78 cm	215.-	225.-
PSS3/90/FTx/PrA	90 cm sirge pendeluks SOLA, anodeeritud profiil	88 cm	200.-	210.-
PSS3/90/FTx/PrG	90 cm sirge pendeluks SOLA, läikiv profiil	88 cm	225.-	235.-
PSS3/X/FTx/PrA	ERIMÕÖT (60-95 cm) sirge pendeluks SOLA, anodeeritud profiil	X	325.-	350.-
PSS3/X/FTx/PrG	ERIMÕÖT (60-95 cm) sirge pendeluks SOLA, läikiv profiil	X	350.-	375.-

* Muutuva parameeter koodis: FTx - klaasi tüüp; X - toote laius

PAIGUTUS: UKS

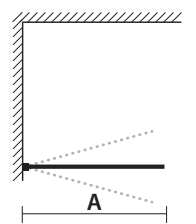

MODE (nurk)



SOLA

FOLD

- Universaalne 190 cm kõrgune voldik-pendeluks (PSV2) erinevate paigaldusvõimalustega - üksiku ukse või dushinurgaks paigutatuna.
- Dushinurk eeldab kahe ukse valimist - kokku saab kombineerida eri mõõdus uksti.
- Dushinurk on kombineeritav ka tootega MODE.
- Saadaval nii standardlaiusena kui erimõõdus valitud laiusena.
- PS. Käeline toode!

TOODE KOOSNEB:

190 cm voldikhingega pendeluks (vasak/parem), 6 mm karastatud sirge klaas (kirkas/toonitud), alumiiniumprofiil (anodeeritud/läikiv), käepide, ukse magnetihend, alumiine veetihend, kinnitustarvikud

PAIGUTUS:

UKS

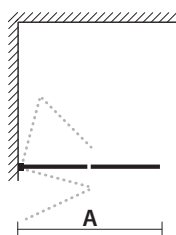

NURK

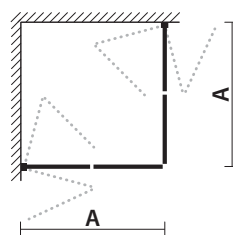

NIŠŠ

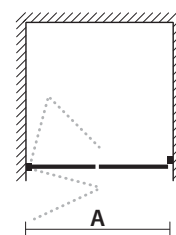

HINNAD JA TEHNILINE INFO:

Kood*	Toote kirjeldus	Ava mõõt***			Hind FT1
		A (nišš)	A (uks)	A (nurk)	
PSV2L/70/FT1/PrA	70 cm voldik-pendeluks FOLD, anodeeritud profiil (vasak)	680 mm	68 cm	70 cm	325.-
PSV2R/70/FT1/PrA	70 cm voldik-pendeluks FOLD, anodeeritud profiil (parem)	680 mm	68 cm	70 cm	325.-
PSV2L/70/FT1/PrG	70 cm voldik-pendeluks FOLD, läikiv profiil (vasak)	680 mm	68 cm	70 cm	350.-
PSV2R/70/FT1/PrG	70 cm voldik-pendeluks FOLD, läikiv profiil (parem)	680 mm	68 cm	70 cm	350.-
PSV2L/80/FT1/PrA	80 cm voldik-pendeluks FOLD, anodeeritud profiil (vasak)	780 mm	78 cm	80 cm	335.-
PSV2R/80/FT1/PrA	80 cm voldik-pendeluks FOLD, anodeeritud profiil (parem)	780 mm	78 cm	80 cm	335.-
PSV2L/80/FT1/PrG	80 cm voldik-pendeluks FOLD, läikiv profiil (vasak)	780 mm	78 cm	80 cm	360.-
PSV2R/80/FT1/PrG	80 cm voldik-pendeluks FOLD, läikiv profiil (parem)	780 mm	78 cm	80 cm	360.-
PSV2L/90/FT1/PrA	90 cm voldik-pendeluks FOLD, anodeeritud profiil (vasak)	880 mm	88 cm	90 cm	345.-
PSV2R/90/FT1/PrA	90 cm voldik-pendeluks FOLD, anodeeritud profiil (parem)	880 mm	88 cm	90 cm	345.-
PSV2L/90/FT1/PrG	90 cm voldik-pendeluks FOLD, läikiv profiil (vasak)	880 mm	88 cm	90 cm	370.-
PSV2R/90/FT1/PrG	90 cm voldik-pendeluks FOLD, läikiv profiil (parem)	880 mm	88 cm	90 cm	370.-
PSV2L/X/FT1/PrA	ERIMÕÕT (60-95 cm) voldik-pendeluks FOLD, anod. profiil (vasak)**	X	X	X+2 cm	450.-
PSV2R/X/FT1/PrA	ERIMÕÕT (60-95 cm) voldik-pendeluks FOLD, anod. profiil (parem)**	X	X	X+2 cm	450.-
PSV2L/X/FT1/PrG	ERIMÕÕT (60-95 cm) voldik-pendeluks FOLD, läikiv profiil (vasak)**	X	X	X+2 cm	475.-
PSV2R/X/FT1/PrG	ERIMÕÕT (60-95 cm) voldik-pendeluks FOLD, läikiv profiil (parem)**	X	X	X+2 cm	475.-

* Muutuv parameeter koodis: X - toote laius, mm

** Niššiasetuse korral mõõta avaus kolmest kohast (alt, keskelt, ülevalt)

*** Niššiasetuse korral veenduda, et toote paigaldustolerants ± 5 mm on piisav

LISAVARUSTUS:

VPM2

Vastandprofiil magnetiga (asetus nišši)

55.-

KÄELISUS:

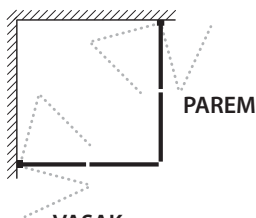

Lühendid: TOOTE TÜÜP: **PSS**-Pendel sein sirge; **FSS**-Fikseeritud sein sirge; **PSV**-Pendelsein voldik; **PNK**-Pendel nurk kumer; **PSK**-Pendel sein kumer. ÜLAKINNITI TÜÜP: **KT**-Kaldtugi; **RT**-Risttugi; **LT**-Laetugi. PROFIIILI TÜÜP: **PrA**-Anodeeritud (matt) alumiiniumprofiil; **PrG**-Läikiv alumiiniumprofiil. KLAASI TÜÜP: **FT1**-Kirkas klaas; **FT2**-Toonitud klaas.

VIBE

DUŠINURK

ESISEIN + SÜVISTATAV ALUS

Mõõdud: **99 x 89 x 198 cm**

ESISEIN + KÕRGE ALUS

Mõõdud: **99 x 89 x 208 cm**

Vibe on valmistatud kerge kumerusega karastatud klaasist. Klaaside valik: kirkas (T1) või toonitud (T2). Alus on valmistatud Xonyx™ kivimassist, mis annab alusele massiivsuse ja tugevuse. Xonyx™ alust on kerge hooldada, ta on kulumisele vastupidav ja mõistlikuse piires taastatav.

Esisein (T1, T2)	890.-
Kõrge alus (valge) 99x89x208 cm	
Esisein (T1, T2)	845.-
Süvistatav alus (valge) 99x89x198 cm	

P.S.

Süvistatava alusega Vibe paigaldamine eeldab paigaldusobjekti ettevalmistust vastavalt paigaldusjuhendile.



Kõrge alus



Süvistatav alus

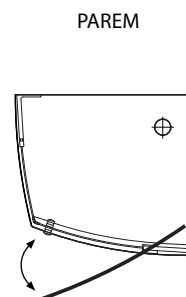
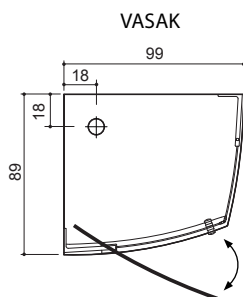
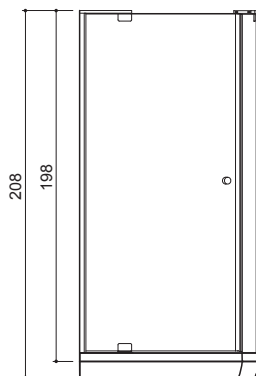

DUŠITOODEDE DETAILID

KLAASI TÜÜP



Kirgas FT1

PROFIILI TÜÜP



Matthöhe, anodeeritud PrA

DETAILID



Voldikhing



Põranda U-profil

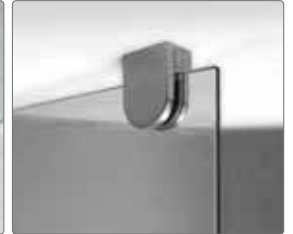

Laekinniti LT6, LT8



Toonitud FT2



Läkiv PrG



Käepide



Seinakaldtugi KT



Seinakaldtugi RT

PS. Profili reguleerimise/seinakalde kompenseerimine: $\pm 0,5$ cm.



DUŠIRUUMI ISTE

- Mõõdud: 325x350x113 cm
- Üles/alla klapitav
- Vannitoa seinalle monteeritav
- Kvaliteetne viimistlus ja vastupidav konstruktsioon
- Veekindel materjal
- Maksimaalne kasutaja kaal: 120 kg

Hind: 125.-





MIO

DUŠIPANEEL -

elegantne vorm, Xonyx kivimassist

- Mõõdud: 24 x 149 x 33 cm
- Kvaliteetne dušisegisti
- Vihmadušš
- Minimalistlik käsidušš
- Veemassaaži düüsid 3 erineva pihustiga
- Varjatud riulid
- Värvilise MIO tellimine vastavalt RAL koodile

XONYX™

- MIO: 1465.-
- MIO (värvitud): 1845.-

Tehniline info lk 82





VANNITOAMÖÖBEL

- Lai valik disainmööblit
- Kvaliteetne ja vastupidav -
MDF korpused
- Kvaliteetne furnituur
- Eestis valmistatud



INTEGRA



Integra 100 ja küljekapp (KIEL, NSS, C75); peegel LY100



Sahtlirest (hele)



Integra 80 (must värvitud, NSS); peegel peegel AQ60

INTEGRA seeria

Isikupärane Solid Surface valamuga mööbliseeria saadaval kolmes laiuses: 80, 100, 120 cm

- Eelkoostatud kapid, korpus ja ukсед 16 mm MDF
- Kapi fassaad ja küljed kiletatud või värvitud (erinevad viimistlused, vt lk 68)
- Kaks laia sahtlit, töökindlad BLUM sahtlisüsteemid - *push-to-open* (PTO, avamine/sulgemine vajutamiselega) või *normal silent slider* (NSS, avamine tõmmates/sulgemine sujuv)
- Valamu lett ja äravoolukork on eksklusiivsest Xonyx kivimassist (satiinse pinnaviimistlusega). Äravoolukork on mitte-suletav.
- Peegel ei kuulu komplekti (valik: lk 67).

XONYX™

HINNAD JA TEHNILINE INFO:

Kood*	Toote kirjeldus	Hind
INT8/PVCxxx/PTO	INTEGRA 80 cm PVC kileviimistlus, <i>push-to-open</i> avamine, integreeritud valamuga	895.-
INT8/PVCxxx/NSS	INTEGRA 80 cm PVC kileviimistlus, <i>normal silent slider</i> avamine, integreeritud valamuga**	875.-
INT8/xxx/PTO	INTEGRA 80 cm värvitud viimistlus, <i>push-to-open</i> avamine, integreeritud valamuga	860.-
INT8/xxx/NSS	INTEGRA 80 cm värvitud viimistlus, <i>normal silent slider</i> avamine, integreeritud valamuga	670.-
INT10/PVCxxx/PTO	INTEGRA 100 cm PVC kileviimistlus, <i>push-to-open</i> avamine, integreeritud valamuga	1110.-
INT10/PVCxxx/NSS	INTEGRA 100 cm PVC kileviimistlus, <i>normal silent slider</i> avamine, integreeritud valamuga**	1020.-
INT10/xxx/PTO	INTEGRA 100 cm värvitud viimistlus, <i>push-to-open</i> avamine, integreeritud valamuga	975.-
INT10/xxx/NSS	INTEGRA 100 cm värvitud viimistlus, <i>normal silent slider</i> avamine, integreeritud valamuga	785.-
INT12/PVCxxx/PTO	INTEGRA 120 cm PVC kileviimistlus, <i>push-to-open</i> avamine, integreeritud valamuga	1330.-
INT12/PVCxxx/NSS	INTEGRA 120 cm PVC kileviimistlus, <i>normal silent slider</i> avamine, integreeritud valamuga**	1165.-
INT12/xxx/PTO	INTEGRA 120 cm värvitud viimistlus, <i>push-to-open</i> avamine, integreeritud valamuga	1095.-
INT12/xxx/NSS	INTEGRA 120 cm värvitud viimistlus, <i>normal silent slider</i> avamine, integreeritud valamuga	895.-
INT4/PVCxxx/PTO	INTEGRA püstine küljekapp, PVC kileviimistlus, <i>push-to-open</i> avamine	495.-
INT4/PVCxxx/NSS	INTEGRA püstine küljekapp, PVC kileviimistlus, <i>normal silent slider</i> avamine**	545.-
INT4/xxx/PTO	INTEGRA püstine küljekapp, värvitud viimistlus, <i>push-to-open</i> avamine	435.-
INT4/xxx/NSS	INTEGRA püstine küljekapp, värvitud viimistlus, <i>normal silent slider</i> avamine	400.-

* Muutuv parameeter koodis: xxx - fassaadi ja külgede viimistlus

** PVC/NSS viimistlus sisaldab käepidemeid (valik: C10 - harjatud teras; C75 - värvitud must)

LISAVARUSTUS:

Kood*	Toote kirjeldus	Hind
INTx/SRH	Sahtli puidust sisejaotusrest (80, 100, 120 cm), hele	65.-
INTx/SRT	Sahtli puidust sisejaotusrest (80, 100, 120 cm), tume	65.-
LED	Sahtli LED sisevalgustus (ühele sahtlile, patareitoide)	60.-

* Muutuv parameeter koodis: x - mööbli laius

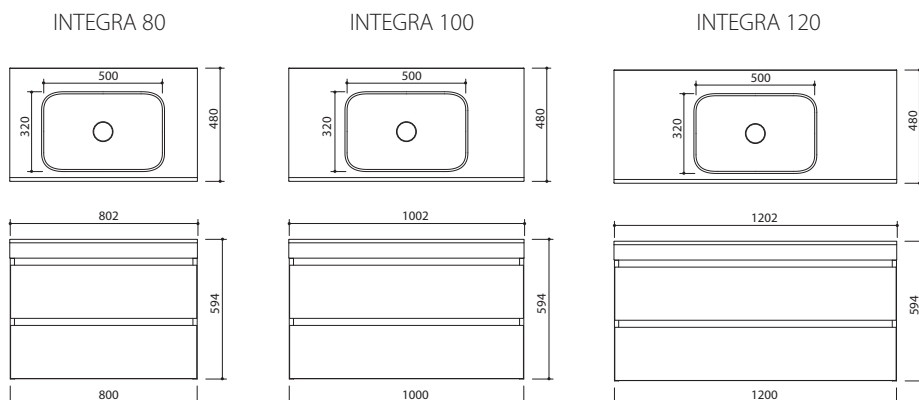

INTEGRA
Püstine küljekapp

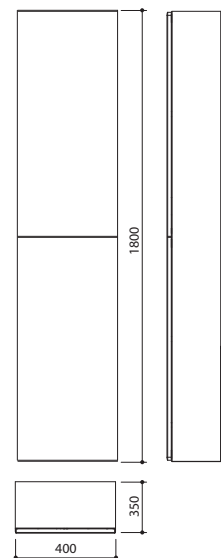

PIANO



Piano 120 Solid Surface (PORT); valamu Deco; peegel LY60



Piano 160 valumarmor (valge kõrgläige); integreeritud valamuletiga



Valamu Milo

PIANO seeria, *Solid Surface*

Piano *Solid Surface* vannitoamööbeli komplekt on valmistatud kõrgekvaliteetsest kiletatud MDF-st ja Xonyx™ kivimassist letist ning valamust

- Eelkoostatud kapid, korpus ja ukсед 16 mm MDF
- Kapi fassaad kiletatud (erinevad viimistlused, vt lk 66), kapi korpus värvitud hall
- Töökindel sahtlisüsteem *normal silent slider* (NSS, avamine tõmmates/sulgemine sujuv)
- Kapipealne lett ja valamu Xonyx kivimassist (satiinse pinnaviimistlusega, äravoolukork on mitte-suletav).
- Peegel ei kuulu komplekti (valik lk 65).

XONYX™

Kood*	Toote kirjeldus	Hind
MILO	Valamu MILO (58x40x15 cm), letipealne, XONYX materjal	240.-
DECO	Valamu DECO (55x40x15 cm), letipealne, XONYX materjal	240.-
PIA12/xxx/SS1220	PIANO mööblikomplekt 120 cm, kõrge, valamulett (avaus vasakul), XONYX materjal	970.-
PIA12/xxx/SS1230	PIANO mööblikomplekt 120 cm, kõrge, valamulett (avaus paremal), XONYX materjal	970.-
PIA4/xxx/2842	PIANO kõrge küljekapp, sügavus 18 cm, kahe uksega	310.-
PIA4/xxx/2843	PIANO kõrge küljekapp, sügavus 35 cm, kahe uksega	345.-

* Muutuv parameeter koodis: xxx - fassaadi viimistlus

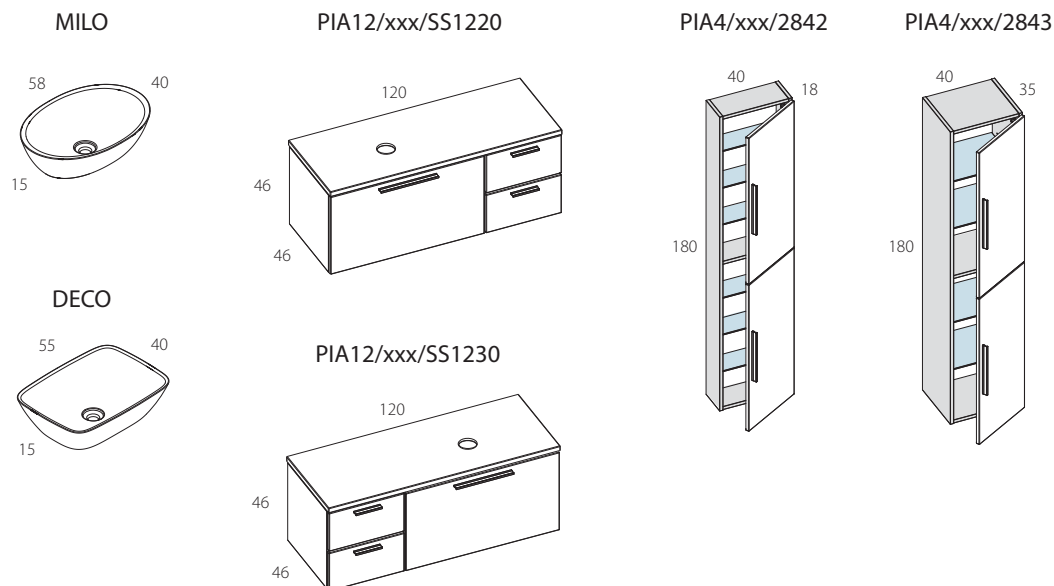

PIANO VALUMARMOR MÖÖBLI MOODULID:

ALUMINE KAPP

408/1684

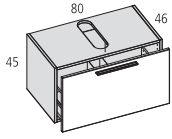

408/1884

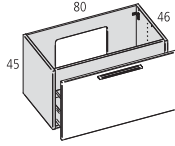

408/1144

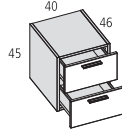

VALAMU (letipealne)

CUP2/4225



BOWL/4225



KÜLJEKAPP

408/2842

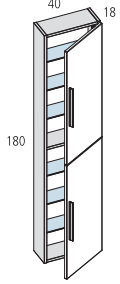

408/2843

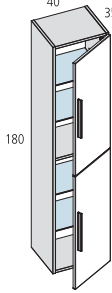

VÄIKE KAPP

408/2342

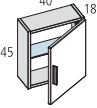

408/2442

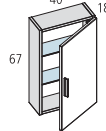

PEEGEL

408/3460

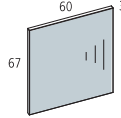

408/3480

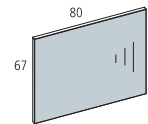

408/3280

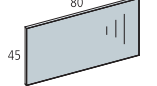

VALAMU (integreeritud)

126/0810

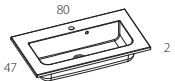

126/1220

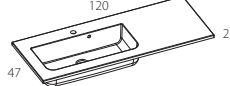

126/1610

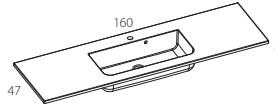

126/2023

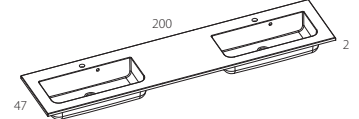

126/1230

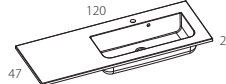

126/1620

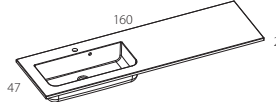

126/1630

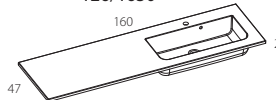

VALAMULETT (letipealsele valamule)

114/0810

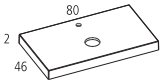

114/1220

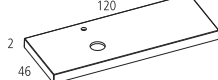

114/1610

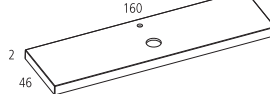

114/2020

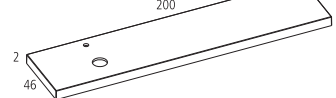

114/1230

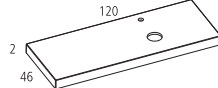

114/1620

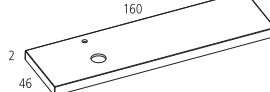

114/2021

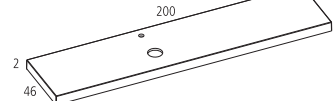

114/1623

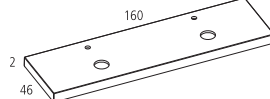

114/2030

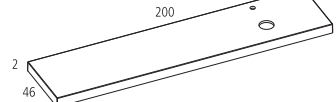

VALGUSTI



114/1630

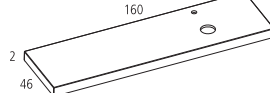

114/2031

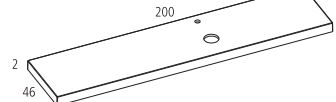

114/2023

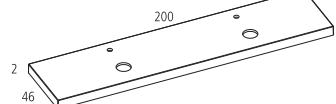

PIANO seeria, valumarmor

Piano valumarmor vannitoamööbel on kombineeritav eri moodulitena kuni 200 cm laiuseks

- Eelkoostatud kapid, korpus ja ukсед 16 mm MDF
- Kapi fassaad kiletatud (erinevad viimistlused, vt lk 68), kapi korpus värvitud hall
- Töökindel sahtlisüsteem *normal silent slider* (avamine tõmmates/sulgemine sujuv)
- Valikus nii letipealne kui ka integreeritud valamu
- Lisapeeglite valik (lk 67).



HINNAD JA TEHNILINE INFO:

Kood*	Toote kirjeldus	Hind
Valgusti:		
M1004/0504209	Valgusti Winter G9, kroonitud, 220V, 2x40W, IP44	148.-
Peegel:		
408/3280	Peegel 80x45x2 cm	155.-
408/3460	Peegel 60x67x2 cm	155.-
408/3480	Peegel 80x67x2 cm	180.-
Väike kapp:		
408/2342/xxx	PIANO väike kapp 40x18x45 cm	98.-
408/2442/xxx	PIANO väike kapp 40x18x67,5 cm	130.-
Valamu (letipealne):		
CUP2/4225	Valamu CUP2, Ø50x15 cm, valumarmor (koos põhjaristiga)	288.-
BOWL/4225	Valamu BOWL, 59x39x15 cm, valumarmor (koos põhjaristiga)	288.-
Valamulett (letipealse valamule):		
114/0810	PIANO valamukapi lett ilma valamuta 80 cm, valumarmor, avaus keskel	130.-
114/1220	PIANO valamukapi lett ilma valamuta 120 cm, valumarmor, avaus vasakul	195.-
114/1230	PIANO valamukapi lett ilma valamuta 120 cm, valumarmor, avaus paremal	195.-
114/1610	PIANO valamukapi lett ilma valamuta 160 cm, valumarmor, avaus keskel	260.-
114/1620	PIANO valamukapi lett ilma valamuta 160 cm, valumarmor, avaus vasakul	260.-
114/1630	PIANO valamukapi lett ilma valamuta 160 cm, valumarmor, avaus paremal	260.-
114/1623	PIANO valamukapi lett ilma valamuta 160 cm, valumarmor, kahe avausega	260.-
114/2020	PIANO valamukapi lett ilma valamuta 200 cm, valumarmor, avaus vasakul	325.-
114/2021	PIANO valamukapi lett ilma valamuta 200 cm, valumarmor, avaus vasakul-keskel	325.-
114/2030	PIANO valamukapi lett ilma valamuta 200 cm, valumarmor, avaus paremal	325.-
114/2031	PIANO valamukapi lett ilma valamuta 200 cm, valumarmor, avaus paremal-keskel	325.-
114/2023	PIANO valamukapi lett ilma valamuta 200 cm, valumarmor, kahe avausega	325.-
Valamu (integreeritud):		
126/0810	PIANO valamukapi lett integreeritud valamuga 80 cm, valumarmor, valamu keskel	395.-
126/1220	PIANO valamukapi lett integreeritud valamuga 120 cm, valumarmor, valamu vasakul	460.-
126/1230	PIANO valamukapi lett integreeritud valamuga 120 cm, valumarmor, valamu paremal	460.-
126/1610	PIANO valamukapi lett integreeritud valamuga 160 cm, valumarmor, valamu keskel	525.-
126/1620	PIANO valamukapi lett integreeritud valamuga 160 cm, valumarmor, valamu vasakul	525.-
126/1630	PIANO valamukapi lett integreeritud valamuga 160 cm, valumarmor, valamu paremal	525.-
126/2023	PIANO valamukapi lett integreeritud valamuga 200 cm, valumarmor, kahe valamuga	860.-
Alumine kapp:		
408/1144/xxx	PIANO alumine kapp 40 cm, kõrge, kahe sahtliga	365.-
408/1684/xxx	PIANO alumine kapp 80 cm, kõrge, ühe sahtliga (letipealsele valamule)	360.-
408/1884/xxx	PIANO alumine kapp 80 cm, kõrge, ühe sahtliga (integreeritud valamule)	380.-
Kõrge küljekapp:		
408/2842/xxx	PIANO kõrge küljekapp 40x18x180 cm	310.-
408/2843/xxx	PIANO kõrge küljekapp 40x35x180 cm	345.-

* Muutuv parameeter koodis: xxx - fassaadi viimistlus

WILLINGEN



Willingen 80 (Wenge), kõrge küljekapp



Willingen 60 (Wenge), 2x kõrge küljekapp



Willingen 120 (valge kõrgläige)

WILLINGEN seeria

Täiskomplektne vannitoamööbel saadaval neljas eri laiuses: 60, 80, 100, 120 cm

- Eelkoostatud kapid, korpus ja ukсед 16 mm MDF
- Töökindel sahtlisüsteem *normal silent slider* (NSS, avamine tõmmates/sulgemine sujuv)
- Kapi fassaad kiletatud (erinevad viimistlused, vt lk 68), kapi korpus värvitud valge
- Lisapeeglite valik (lk 67).



HINNAD JA TEHNILINE INFO:

Kood*	Toote kirjeldus	Hind
Willingen 60		
285/600/30LED	Valgussokkel 60 cm, LED	98.-
507/2862	WILLINGEN peegelustega kapp 60 cm	105.-
121/0610	WILLINGEN valamukapi lett integreeritud valamuga 60 cm, valumarmor	105.-
507/0605/xxx	WILLINGEN valamukapp 60 cm, PVC kileviimistlus	190.-
Willingen 80		
285/800/30LED	Valgussokkel 80 cm, LED	118.-
507/2882	WILLINGEN peegelustega kapp 80 cm	125.-
121/0810	WILLINGEN valamukapi lett integreeritud valamuga 80 cm, valumarmor	125.-
507/0805/xxx	WILLINGEN valamukapp 80 cm, PVC kileviimistlus	215.-
Willingen 100		
285/1000/30LED	Valgussokkel 100 cm, LED	148.-
507/2812	WILLINGEN peegelustega kapp 100 cm	155.-
121/1010	WILLINGEN valamukapi lett integreeritud valamuga 100 cm, valumarmor	140.-
507/1005/xxx	WILLINGEN valamukapp 100 cm, PVC kileviimistlus	225.-
Willingen 120		
285/1200/30LED	Valgussokkel 120 cm, LED	154.-
507/2862 *2	WILLINGEN peegelustega kapp 60 cm (2 tk)	210.-
121/1223	WILLINGEN valamukapi lett integreeritud valamuga 120 cm, valumarmor, kahe valamuga	210.-
507/0605/xxx *2	WILLINGEN valamukapp 60 cm (2 tk), PVC kileviimistlus	380.-
507/2313/xxx	WILLINGEN püstine küljekapp 40x32x125 cm, PVC kileviimistlus	165.-

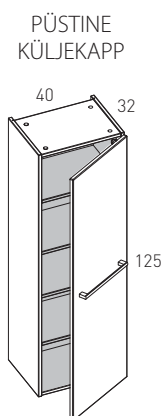

* Muutuv parameeter koodis: xxx - fassaadi viimistlus

WILLINGEN 60

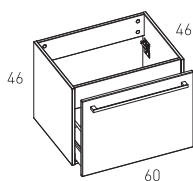
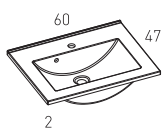
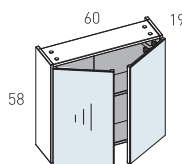
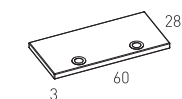

WILLINGEN 80

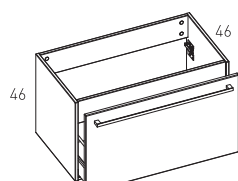
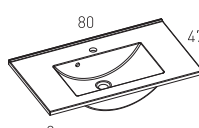
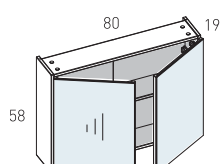
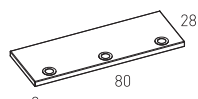

WILLINGEN 100

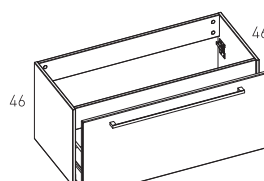
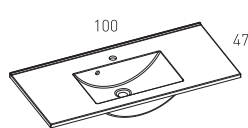
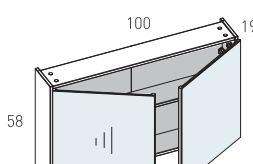
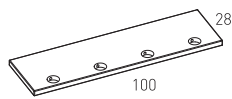

WILLINGEN 120

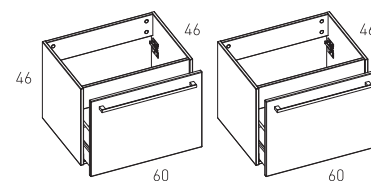
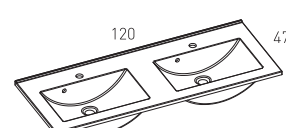
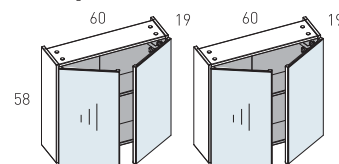
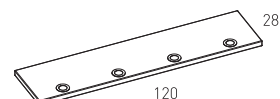

TRIPOL



Tripol 100 (Jakarta tiik), 2x püstine küljekapp



Tripol 80 (valge kõrgläite), püstine küljekapp



Tripol 100 (Wenge)

TRIPOL seeria

Täiskomplektne laia valamuga vannitoamööbel saadaval kahes eri laiuses: 80 ja 100 cm

- Eelkoostatud kapid, korpus ja ukсед 16 mm MDF
- Töökindel sahtlisüsteem *normal silent slider* (NSS, avamine tõmmates/sulgemine sujuv)
- Kapi fassaad kiletatud (erinevad viimistlused, vt lk 68), kapi korpus värvitud valge
- Lisapeeglite valik (lk 67).



HINNAD JA TEHNILINE INFO:

Kood*	Toote kirjeldus	Hind
Tripol 80		
285/800/30LED	Valgussokkel 80 cm, LED	118.-
507/2882	TRIPOL peegelustega kapp 80 cm	125.-
131/0810	TRIPOL valamukapi lett integreeritud valamuga 80 cm, valumarmor	125.-
507/0805/xxx	TRIPOL valamukapp 80 cm, PVC kileviimistlus	215.-
Tripol 100		
285/1000/30LED	Valgussokkel 100 cm, LED	148.-
507/2812	TRIPOL peegelustega kapp 100 cm	155.-
131/1010	TRIPOL valamukapi lett integreeritud valamuga 100 cm, valumarmor	140.-
507/1005/xxx	TRIPOL valamukapp 100 cm, PVC kileviimistlus	225.-
507/2313/xxx	TRIPOL püstine küljekapp 40x32x125 cm, PVC kileviimistlus	165.-

* Muutuv parameeter koodis: xxx - fassaadi viimistlus

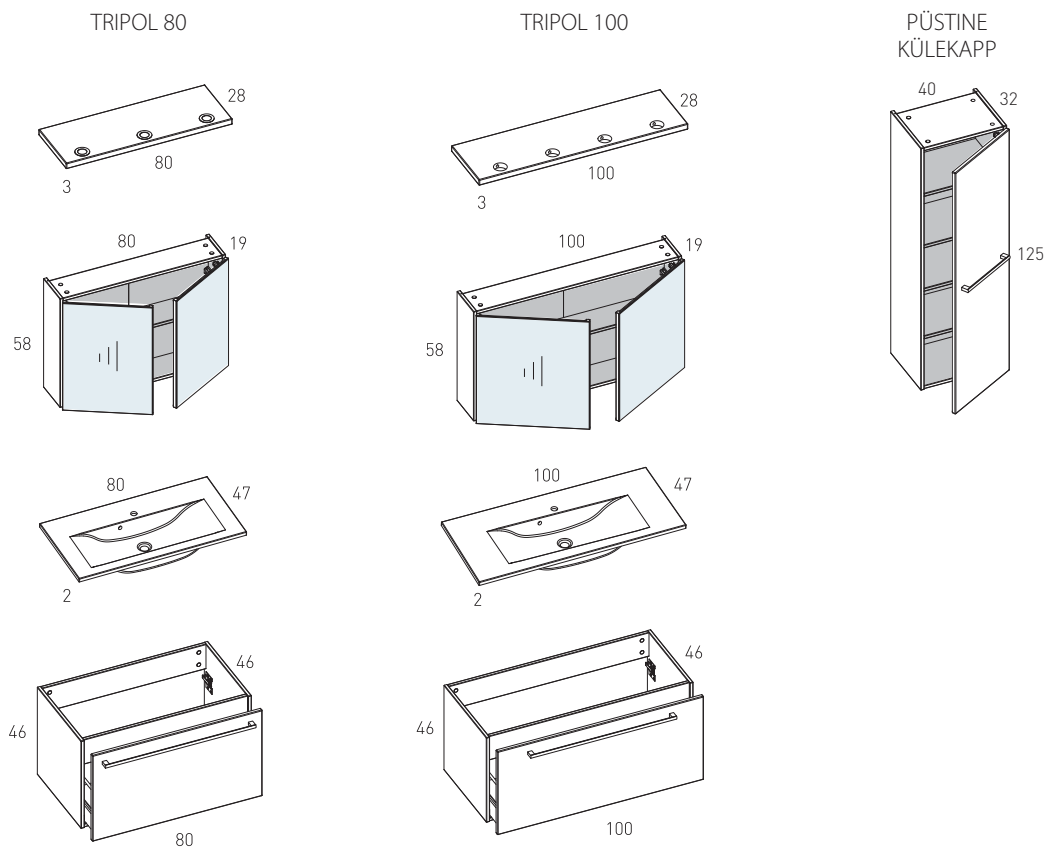

FORTE seeria



HINNAD JA TEHNILINE INFO:

Kood	Toote kirjeldus	Hind
102/0920	Valamu FORTE 90 cm (90x46x4 cm), valumarmor, avaus vasakul	180.-
102/0930	Valamu FORTE 90 cm (90x46x4 cm), valumarmor, avaus paremal	180.-
102/1210	Valamu FORTE 120 cm (120x46x4 cm), valumarmor, avaus keskel	210.-
200/0164M	Aluskapp FORTE 60 cm, 1 riiul (integreeritud valamule)	160.-
200/0934	Aluskapp FORTE 30 cm, 1 riiul, pööratav ukse käelikus	110.-

Kapi fassaad ja korpus värvitud valge. Kapi nupud hinna sees.



200/0164M

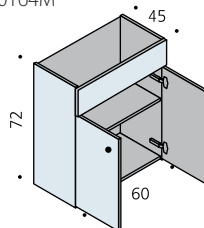

200/0934

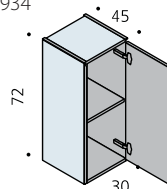

102/0920



102/0930



102/1210



PICCANTE seeria



HINNAD JA TEHNILINE INFO:

Kood	Toote kirjeldus	Hind
123/0610	Valamu PICCANTE 60 cm (60x32x4 cm), valumarmor	115.-
123/0920	Valamu PICCANTE 90 cm (90x32x4 cm), valumarmor, avaus vasakul	155.-
123/0930	Valamu PICCANTE 90 cm (90x32x4 cm), valumarmor, avaus paremal	155.-
500/0164PC	Aluskapp PICCANTE 60 cm, 1 riiul (integreeritud valamule)	165.-
500/0933	Aluskapp PICCANTE 30 cm, 1 riiul, pööratav ukse käelikus	110.-

Kapi fassaad valge kõrgläige kile (PVC060), korpus värvitud valge. Kapi nupud hinna sees.



500/0163PC

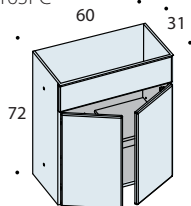

500/0933

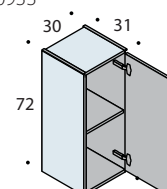

123/0610



123/0920



123/0930



PEEGLID



VE 120

VE-SEERIA

- Taustvalgustusega peegel (LED)
- Infrapuna sensor koos sumeda valguse opsiooniga
- Peegli soojendus (udueemaldus) koos on/off lülitiga (IP44)
- Varustatud turvalise PVC kilega peegliklaasi tagaküljel
- Peegli paksus on 5mm

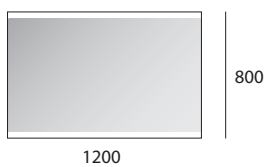

VE120

Hind: 370.-



AQ 120

AQ-SEERIA

- Taustvalgustusega peegel (LED)
- Infrapuna sensor koos sumeda valguse opsiooniga (ainult AQ60)
- Digitaalne kell, valgete numbritega (ainult AQ60)
- Peegli soojendus (udueemaldus) koos on/off lülitiga (IP44)
- Varustatud turvalise PVC kilega peegliklaasi tagaküljel
- Peegli paksus on 5mm
- Ümarad nurgad

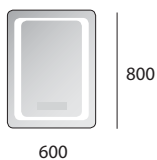

AQ60

Hind: 290.-

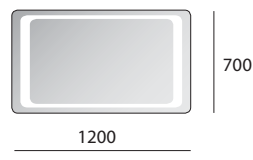

AQ120

Hind: 425.-



LY 60

LY-SEERIA

- Taustvalgustusega peegel (LED)
- Infrapuna sensor koos sumeda valguse opsiooniga
- Taustvalgusega meigipeegel (3x suurendus)
- Peegli soojendus (udueemaldus) koos on/off lülitiga (IP44)
- Varustatud turvalise PVC kilega peegliklaasi tagaküljel
- Peegli paksus on 5mm
- Ümarad nurgad

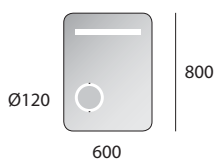

LY60

Hind: 280.-

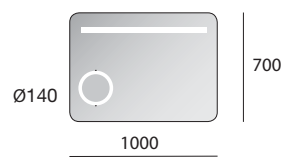

LY100

Hind: 355.-

MÖÖBLI FASSAADI VÄRVIVALIK

PVC KILEVIIMISTLUS:

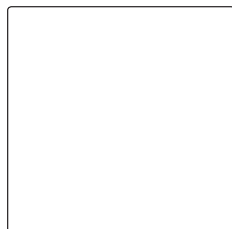

VALGE
kõrgläige
PVC060



MUST
kõrgläige
PVC062

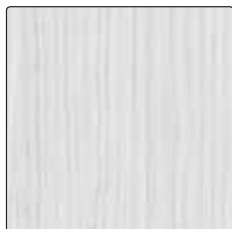

PORT VALGE
valge puu imitatsioon
PVC056



KIEL
hele puu imitatsioon
PVC063

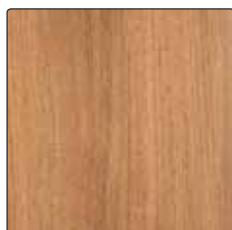

JAKARTA TEAK
PVC044

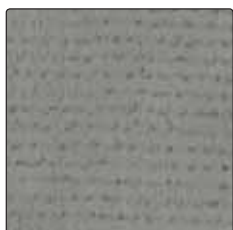

MOUL
hall mustiline
PVC064

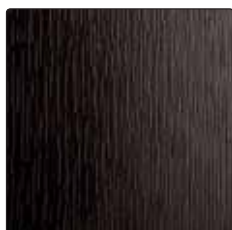

WENGE
PVC045

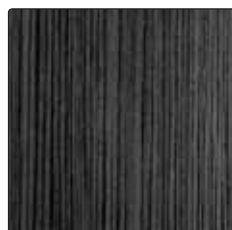

PORT MUST
tume puu imitatsioon
PVC057

VÄRVITUD VIIMISTLUS:

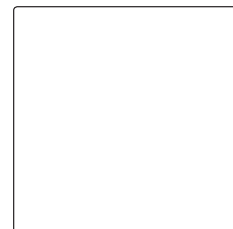

VALGE
kõrgläige
WH



MUST
poolmatt
BL

	PVC060	PVC062	PVC056	PVC063	PVC044	PVC064	PVC045	PVC057	WH	BL
	Valge kõrgläige	Must kõrgläige	PORT valge	KIEL	JAKARTA TEAK	MOUL	WENGE	PORT must	Valge kõrgläige	Must poolmatt
INTEGRA	o	-	-	o	-	o	-	o	o	o
PIANO solid surface	o	o	o	-	o	-	o	o	-	-
PIANO valumarmor	o	o	o	-	o	-	o	o	-	-
WILLINGEN	o	o	o	-	o	-	o	-	-	-
TRIPOL	o	o	o	-	o	-	o	-	-	-
FORTE	-	-	-	-	-	-	-	-	o	-
PICCANTE	o	-	-	-	-	-	-	-	-	-



VALAMUD

XONYX™

MILO
Solid Surface

58 x 40 x 15 cm

Hind: 240.-

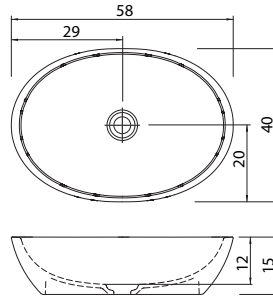

XONYX™

DECO
Solid Surface

55 x 40 x 15 cm

Hind: 240.-

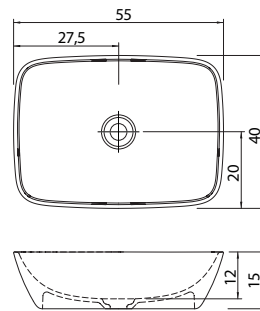

VALU
MARMOR

BOWL
valumarmor

59 x 39 x 15 cm

Hind: 288.-
(põhjaristiga)

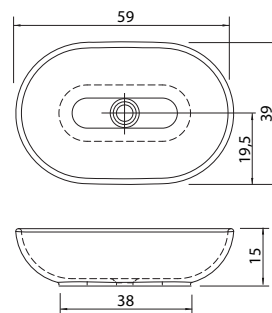

VALU
MARMOR

CUP2
valumarmor

Ø 50 x 15 cm

Hind: 288.-
(põhjaristiga)

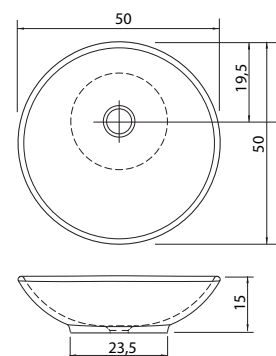

Xonyx valamu Milo

XONYX™ FIORE

160 x 72 x 61 cm / 210 l

Kaal (ilma veeta): 92 kg

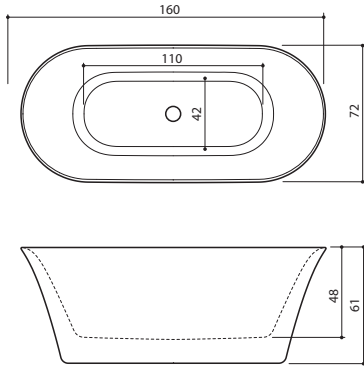

XONYX™ HALO

170 x 72 x 63 cm / 250 l

Kaal (ilma veeta): 110 kg

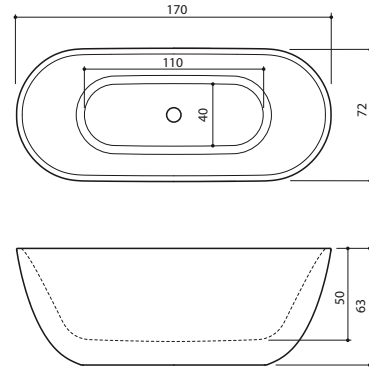

XONYX™ AZUR 140

140 x 70 x 61 cm / 215 l

Kaal (ilma veeta): 90 kg

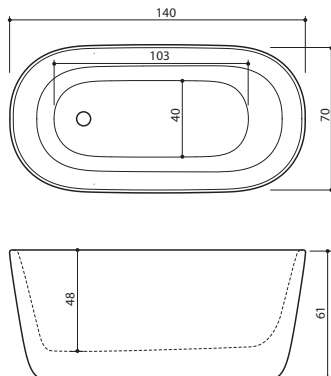

XONYX™ AZUR 155

154 x 70 x 63 cm / 240 l

Kaal (ilma veeta): 99 kg

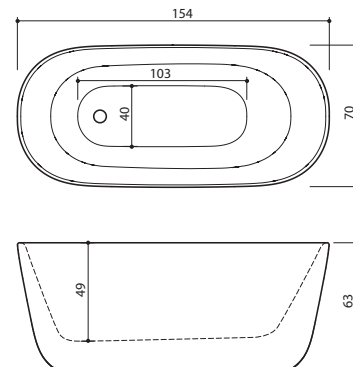

XONYX™ GAMMA 150

150 x 62/85 x 64 cm / 240 l

Kaal (ilma veeta): 85 kg

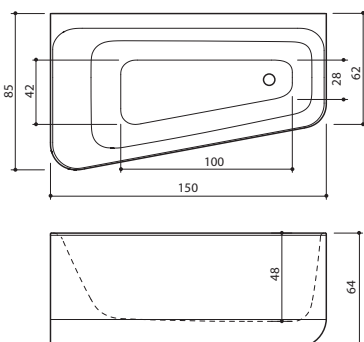

XONYX™ GAMMA 160

160 x 71 x 62 cm / 260 l

Kaal (ilma veeta): 95 kg

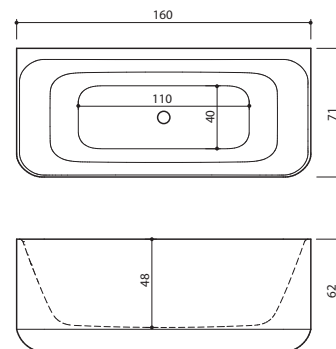

FLO XONYX™

169 x 84 x 63 cm / 240 l
Kaal (ilma veeta): 107 kg

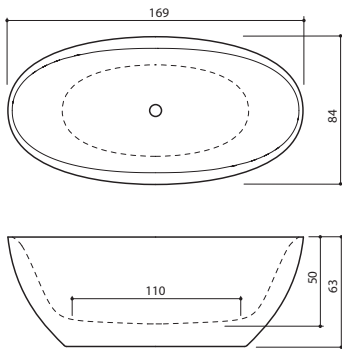

FLO wall XONYX™

169 x 94 x 63 cm / 240 l
Kaal (ilma veeta): 108 kg

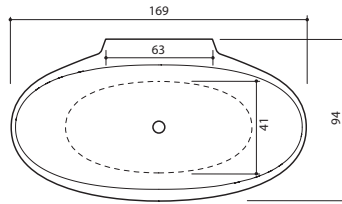

VERO XONYX™

167 x 74 x 62/67 cm / 230 l
Kaal (ilma veeta): 99 kg

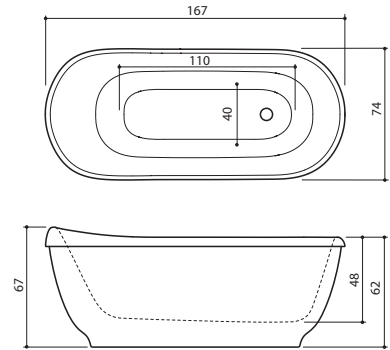

MEZZO XONYX™

182 x 86 x 64/80 cm / 250 l
Kaal (ilma veeta): 133 kg

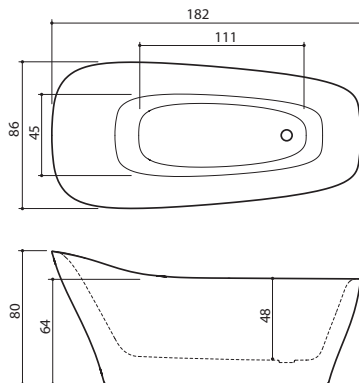

SENZO XONYX™

178 x 88 x 65 cm / 280 l
Kaal (ilma veeta): 125 kg

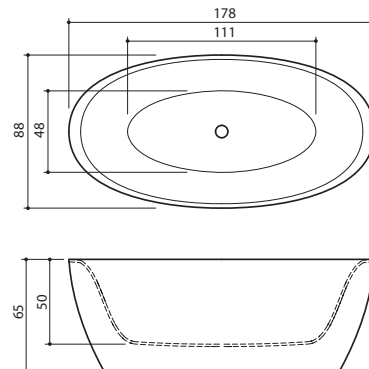

DUNE XONYX™

174 x 77 x 63 cm / 260 l
Kaal (ilma veeta): 104 kg

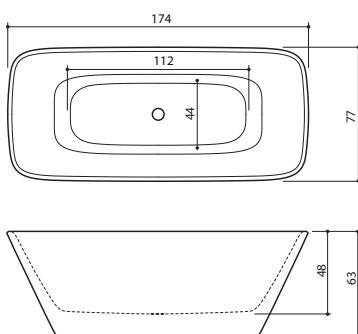

DUNE wall XONYX™

174 x 87 x 63 cm / 260 l
Kaal (ilma veeta): 105 kg

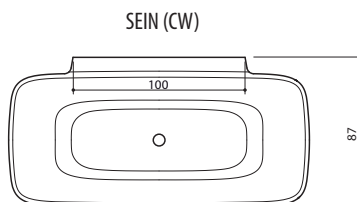

DUNE corner XONYX™

181 x 87 x 63 cm / 260 l
Kaal (ilma veeta): 116 kg

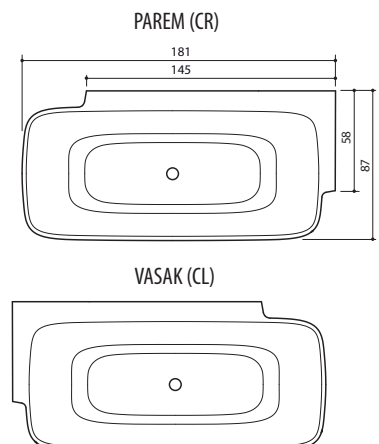

INTEGRA 170

170 x 80 x 61 cm / 260 l

Kaal (ilma veeta): 96 kg

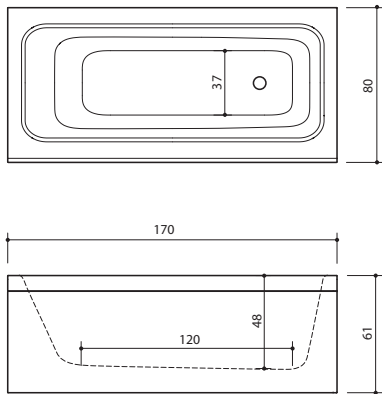

XONYX™

INTEGRA 210

209 x 80 x 61 cm / 260 l

Kaal (ilma veeta): 141 kg

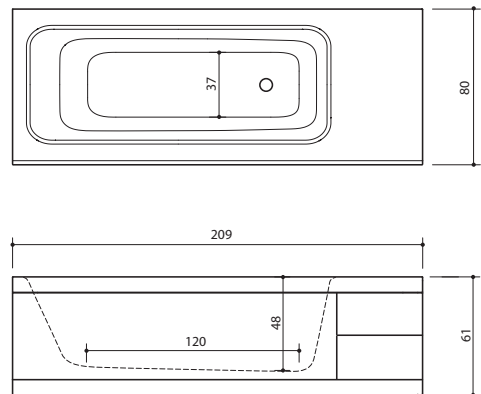

Paneelide asetus (Integra 170):

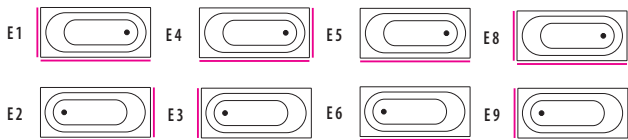

E12 Paneelideta

Paneelide asetus (Integra 210):

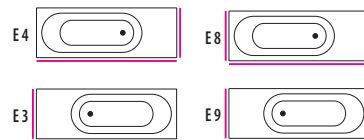

MDF paneelide viimistlus: PVC kile optsioonid (Integra 170; 210):



KIEL
Hele puit imitatsioon
PVC063



PORT
Tume puit imitatsioon
PVC057



MOUL
Hall mustiline
PVC064

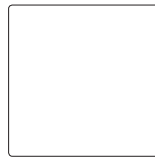

VALGE
Kõrgläige
PVC060

PS! Xonyx toodete gabariitmõõtmete tolerants: ±1%

PIANO; PIANO HYDRO

171 x 101/65 x 67 cm / 290 l

Kaal (ilma veeta): 75/98 kg

PANEELID



E15 (parem)

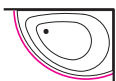

E16 (vasak)

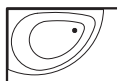

E12R (paneelita)

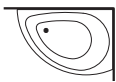

E12L (paneelita)

PIANO HYDRO

- Pianot on võimalik tellida ka massaažvannina.
- S11 - SlimLine Hydro süsteem (täisintegreeritud elektrooniline massaažifunktsioonide juhtimine).

- Vann on valmistatud kivimassist Xonyx. Dekoratiivne esipaneel on valmistatud komposiitmaterjalist. Piano on varustatud kroomitud äravooluga ja ülevooluga.

- Dekoratiivne esipaneel: valge (vaikimisi) või must

SEGISTI



Alpi (kood: A3) 602.-

LISAD

- Veealune halogeenvalgustus SlimLine 275.-
- Tellides vanni ilma esipaneelita, lahuta hinnast 200.-

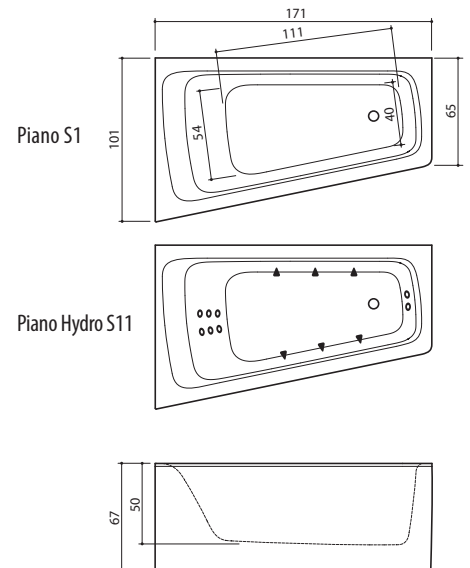

XONYX™ VARIO

DUŠIKABIIN+AURUSAUN+MASSAAŽIVANN

168 x 79 x 218 cm

Klaaside valik:

T1 - Kirgas turvaklaas, 6 mm
T2 - Toonitud turvaklaas, 6 mm

Klaasi kilede valik:



Must (B)

Hall (G)

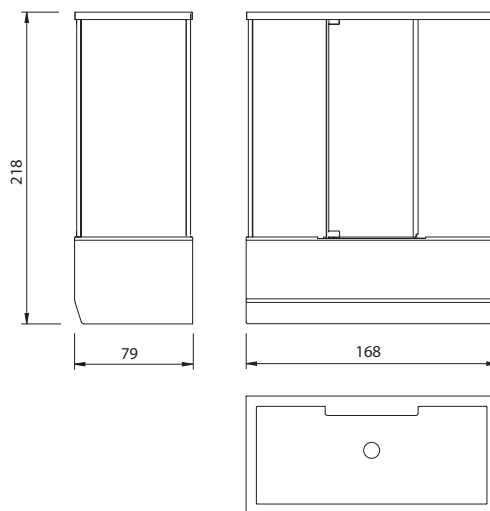

Paigutuse võimalused:

Vario on võimalik tellida vasaku- või paremakäeliseks, mis määrab ühtlasi ära ka esipaneeli ja otsapaneeli asetuse ning ukse avanemise.

Klaaside maskimise (F1, F2, F3) võimalused:

Vario nurka paigutamise korral on võimalus tellida küljeklaasid läbipaistmatuna (joonisel katkendlik joon), lisades koodi:

Tagumised klaasid on standardlahenduses kaetud musta kilega.

Paigaldamisel vajalik ligipääs toote kitsamas otsas 40 cm. Paigaldamiseks vajalik ruumi minimaalne kõrgus 227 cm.

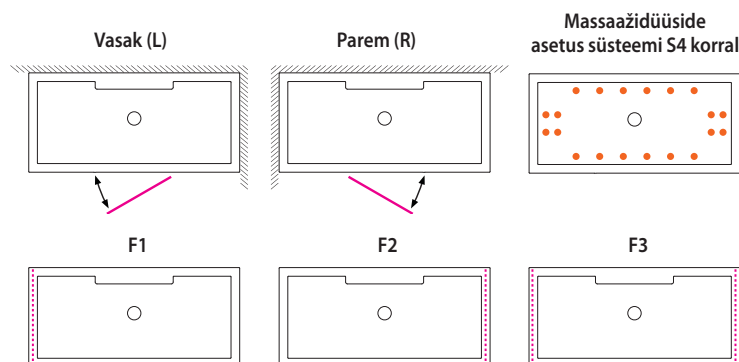

PS! Xonyx toodete gabariitmõõtmete tolerants: ±1%

XONYX™ TETRIS

DUŠIKABIIN-AURUSAUN KAHELE

94 x 141 x 217 cm

Klaaside valik:

T1 - Kirgas turvaklaas, 6 mm
T2 - Toonitud turvaklaas, 6 mm

Otsaplaat:



Peegeldav
klaas (must)

Klaasi kile:



Hall (G)

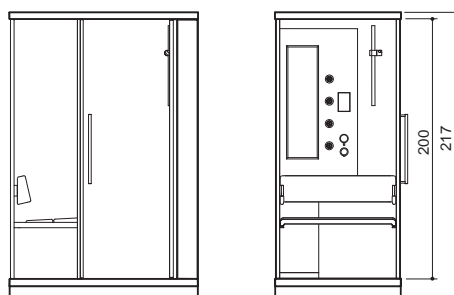

Paigutuse võimalused:

Tetrist on võimalik tellida kas vasaku- või paremakäeliseks.

Klaaside maskimise (M1, M2, M3, M4, M5) võimalused:

Tetrise paigutamisel nurka on võimalus tellida vastu seina minevad küljeklaasid kiled läbipaistmatutena (joonisel katkendlik joon).

Paigaldamisel vajalik ligipääs toote kitsamas otsas 40 cm. Paigaldamiseks vajalik ruumi minimaalne kõrgus 227 cm.

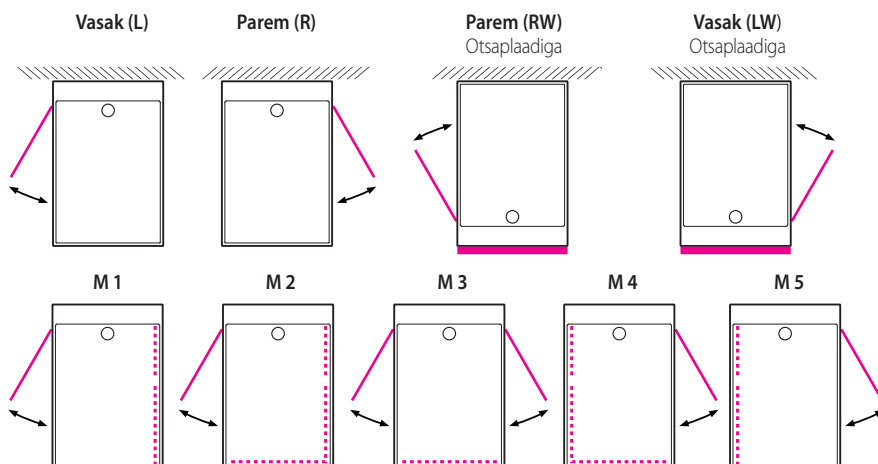

Forma 150 (kood: F05) / 160 (kood: F06) / 170 (kood: F07) / 180 (kood: F08)

150x70x61 cm / 190_160x70x62 cm / 210_170x75x64 cm / 265_179x80x65 cm / 300l

SÜSTEEMID	S1	S3	S4	S6	S7	S8	S10	S11
VEEDÜÜSID	-	6+8	6+8	-	6+8	-	-	6+8
ÕHUDÜÜSID	-	-	12	-	12	-	-	-
PUMBAD	-	1	1	-	1	-	-	1
PUHURID	-	-	1	-	1	-	-	-

Näidiskood: F05 / S1 / E1 / C2 / ...

Koodi selgitus: vanni mudel süsteem esipaneeli asetus vanni segisti

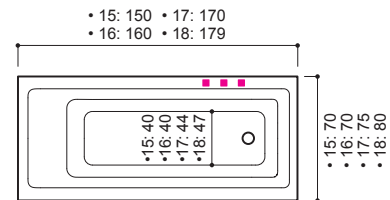

ESIPANEELI ASETUS

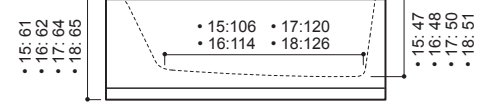

MASSAAŽIPAKETID

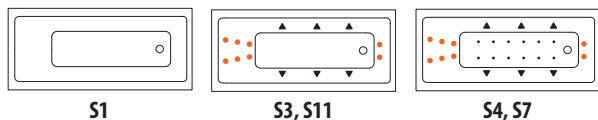

VÕIMALIKUD SEGISTI ASETUSED VANNI ÄÄREL

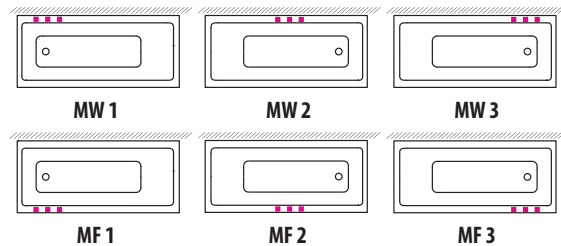

VANNISEGISTID



LISAD



Forma 190 (F09) 190 x 86 x 66 cm / 330 l

SÜSTEEMID	S1	S3	S4	S6	S7	S8	S10	S11
VEEDÜÜSID	-	8+8	8+8	8+12	8+8	8+12	8+12	8+8
ÕHUDÜÜSID	-	-	12	-	12	12	12	-
PUMBAD	-	1	1	2	1	2	2	1
PUHURID	-	-	1	-	1	1	2	-

Näidiskood: F09 / S6 / E19 / DC / MSV*2

Koodi selgitus: vanni mudel süsteem esipaneeli asetus vanni segisti 2 pehmet patja

ESIPANEELI ASETUS

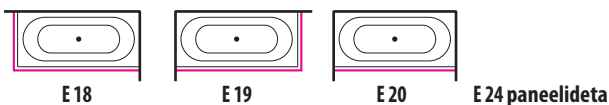

SELJAMASSAAŽ ÜHE PUMBAGA

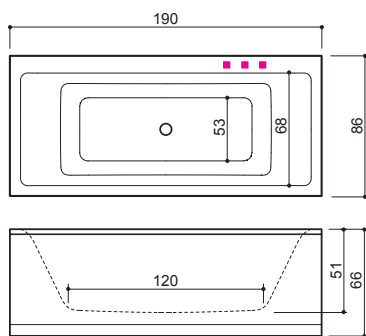
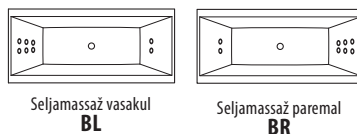

MASSAAŽIPAKETID

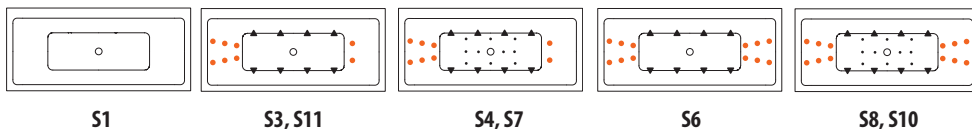

VANNISEGISTID



LISAD



VÕIMALIKUD SEGISTI ASETUSED VANNI ÄÄREL

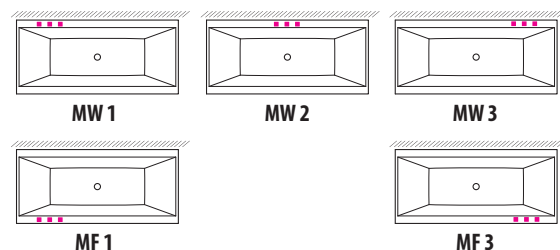

Kirgas klaas (kood: V51/T1)
Toonitud klaas (kood: V51/T2)
Dušisein 185.-

Modul 150 (kood: M05) / 160 (kood: M06) / 170 (kood: M07)

150x70x63cm / 205|_160x70x64cm / 230|_170x75x66cm / 260|

Näidiskood: M07 / S3 / E2 / C1 / OS

Koodi selgitus: vanni mudel süsteem esipaneeli asetus vanni segisti ülevoolust täitmine

SÜSTEEMID	S1	S3	S4	S6	S7	S8	S10	S11
VEEDÜÜSID	-	6+8	6+8	-	6+8	-	-	6+8
ÕHUDÜÜSID	-	-	9	-	9	-	-	-
PUMBAD	-	1	1	-	1	-	-	1
PUHURID	-	-	1	-	1	-	-	-

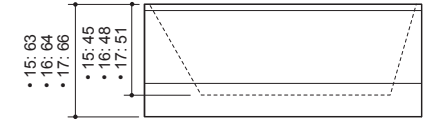
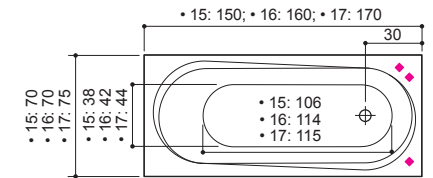

ESIPANEELI ASETUS

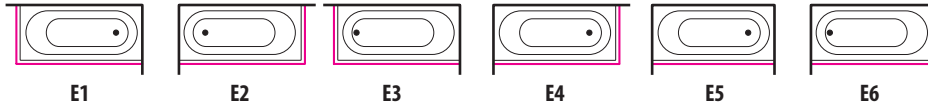

E12 paneelideta

MASSAAŽIPAKETID

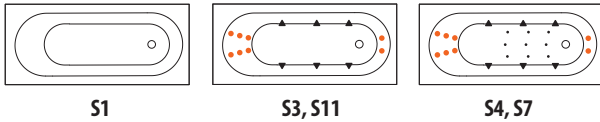

VÕIMALIKUD SEGISTI ASETUSED VANNI ÄÄREL

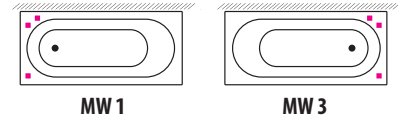

VANNISEGISTID



Christina (kood: C1)
295.-

Christina (kood: C2)
365.-

Christina (kood: C1Z1)
315.-

Christina (kood: C2Z1)
385.-

LISAD



Kirgas klaas (kood: V51/T1)
Toonitud klaas (kood: V51T2)
Dušisein 185.-

Automaatne täitmine
(kood: AF) 145.-

Modul 180 (M08) 179 x 80 x 67 cm / 250 |

Näidiskood: M08 / S8 / E20 / C1Z1 / MSV*2

Koodi selgitus: vanni mudel süsteem esipaneeli asetus vanni segisti 2 pehmet patja

SÜSTEEMID	S1	S3	S4	S6	S7	S8	S10	S11
VEEDÜÜSID	-	8+8	8+8	8+12	8+8	8+12	-	8+8
ÕHUDÜÜSID	-	-	10	-	10	10	-	-
PUMBAD	-	1	1	2	1	2	-	1
PUHURID	-	-	1	-	1	1	-	-

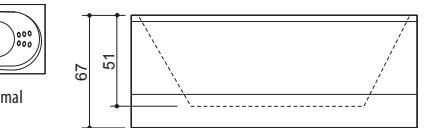
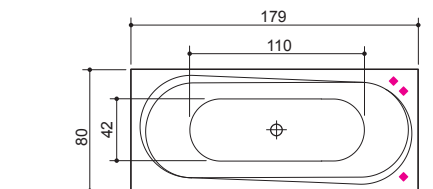

ESIPANEELI ASETUS

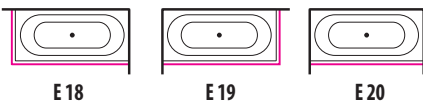

E24 paneelideta

SELJAMASSAAŽ ÜHE PUMBAGA

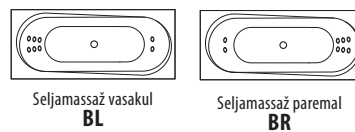

Seljmassaaž vasakul
BL

Seljmassaaž paremal
BR

MASSAAŽIPAKETID

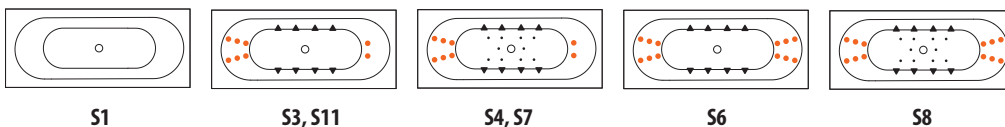

VANNISEGISTID



Christina (kood: C1)
295.-

Christina (kood: C2)
365.-

Christina (kood: C1Z1)
315.-

Christina (kood: C2Z1)
385.-

LISAD



Kirgas klaas (kood: V51/T1)
Toonitud klaas (kood: V51T2)
Dušisein 185.-

Automaatne täitmine
(kood: AF) 145.-

VÕIMALIKUD SEGISTI ASETUSED VANNI ÄÄREL

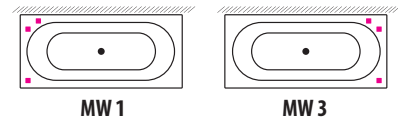

Roma (ROM) 179 x 80 x 67 cm / 235 l

Näidiskood: ROM / S4 / E19 / C2 / MSV*2

Koodi selgitus: vanni mudel süsteem esipaneeli asetus vanni segisti 2 pehmet patja

SÜSTEEMID	S1	S3	S4	S6	S7	S8	S10	S11
VEEDÜÜSID	-	8+8	8+8	8+12	8+8	8+12	-	8+8
ÕHUDÜÜSID	-	-	10	-	10	10	-	-
PUMBAD	-	1	1	2	1	2	-	1
PUHURID	-	-	1	-	1	1	-	-

ESIPANEELI ASETUS

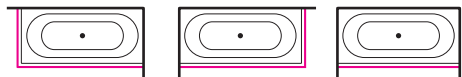

E18

E19

E20

E24 paneelideta

SELJAMASSAAŽ ÜHE PUMBAGA

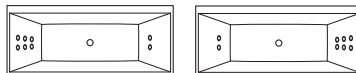

Seljmassaaž vasakul
BL

Seljmassaaž paremal
BR

MASSAAŽIPAKETID

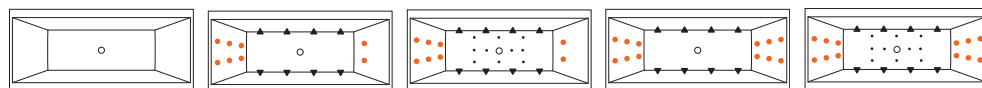

S1

S3, S11

S4, S7

S6

S8

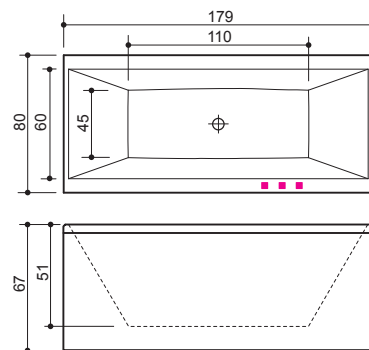

VANNISEGISTID



Christina (kood: C1)
295.-

Christina (kood: C2)
365.-



Christina (kood: C1Z1)
315.-

Christina (kood: C2Z1)
385.-

LISAD



Kirgas klaas (kood: VS1/T1)
Toonitud klaas (kood: VS1T2)
Dušisein 185.-



Ülevoolust täitmine
(kood: OS) 95.-



Pehme padi
(kood: MSV) 35.-



Automaatne täitmine
(kood: AF) 145.-

VÕIMALIKUD SEGISTI ASETUSED VANNI ÄÄREL

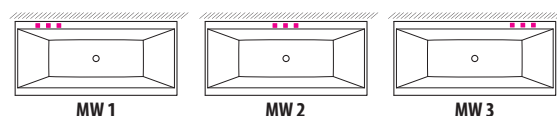

MW 1

MW 2

MW 3

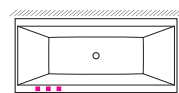

MF 1

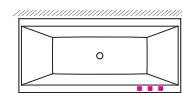

MF 3

Loop (L00) 189 x 89 x 67 cm / 300 l

Näidiskood: LOO / S11 / E18 / C1Z1(MW1) / OS / AF

Koodi selgitus: vanni mudel süsteem esipaneeli asetus vanni segisti ülevoolust täitmine autom. täitmine

SÜSTEEMID	S1	S3	S4	S6	S7	S8	S10	S11
VEEDÜÜSID	-	8+8	8+8	8+12	8+8	8+12	8+12	8+8
ÕHUDÜÜSID	-	-	12	-	12	12	12	-
PUMBAD	-	1	1	2	1	2	2	1
PUHURID	-	-	1	-	1	1	2	-

ESIPANEELI ASETUS

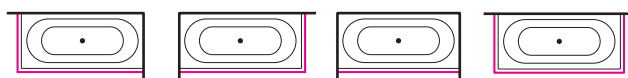

E18

E19

E20

E21

E24 paneelideta

PS!

• E21 puhul lisandub otsapaneeli hind: 45eur.

MASSAAŽIPAKETID

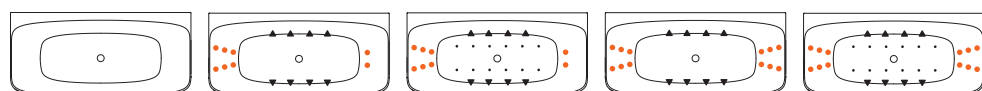

S1

S3, S11

S4, S7

S6

S8, S10

VANNISEGISTID



Damixa Clover
(kood: DC) 567.-

Damixa Jupiter
(kood: DJ1) 515.-

C1 Christina
(kood: C1) 295.-

Christina
(kood: C2) 365.-



Alpi
(kood: A3) 395.-

Christina
(kood: C1Z1) 315.-

C2Z1 Christina
(kood: C2Z1) 385.-

LISAD



Ülevoolust täitmine
(kood: OS) 95.-

Pehme padi
(kood: MSV) 35.-



Automaatne täitmine
(kood: AF) 145.-

VÕIMALIKUD SEGISTI ASETUSED VANNI ÄÄREL

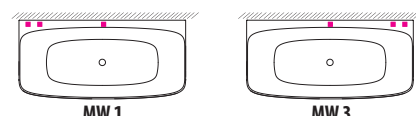

MW 1

MW 3

SELJAMASSAAŽ ÜHE PUMBAGA

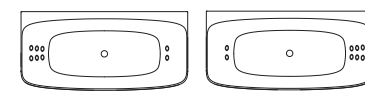

Seljmassaaž vasakul
BL

Seljmassaaž paremal
BR

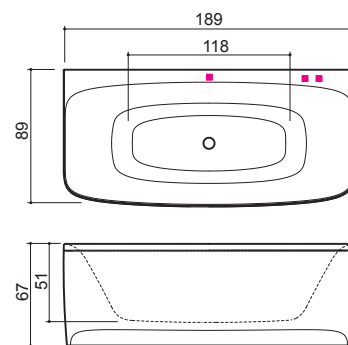

Eclipse 150 (kood: E51 vasak / E52-parem) 150x95x63cm / 220l
Eclipse 160 (kood: E61-vasak / E62-parem) 160x95x63cm / 240l
Eclipse 170 (kood: E71-vasak / E72-parem) 169x97x65cm / 280l

SÜSTEEMID	S1	S3	S4	S6	S7	S8	S10	S11
VEEDÜÜSID	-	6+8	6+8	-	6+8	-	-	6+8
ÕHUDÜÜSID	-	-	9	-	9	-	-	-
PUMBAD	-	1	1	-	1	-	-	1
PUHURID	-	-	1	-	1	-	-	-

ESIPANEELI ASETUS

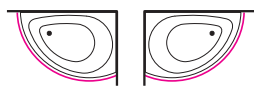

E 16 (vasak) E 15 (parem) E12 paneelideta

MASSAAŽIPAKETID

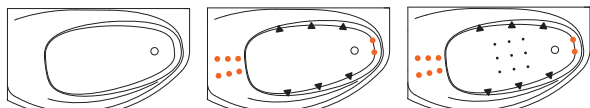

S1

S3, S11

S4, S7

VANNISEGISTID



Damixa Clover
(kood: DC) 567.-



Damixa Jupiter
(kood: DJ1) 515.-



C1 Christina
(kood: C1) 295.-



Christina
(kood: C2) 365.-



Alpi
(kood: A3) 395.-



Christina
(kood: C1Z1) 315.-



C2Z1 Christina
(kood: C2Z1) 385.-

Näidiskood: E52 / S1 / E15 / DC /

Koodi selgitus: vanni mudel süsteem esipaneeli asetus vanni segisti

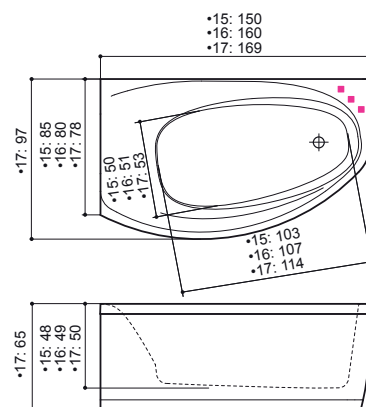

PS!

- Võimalik komplekteerida toonitud (T2) turv klaasist dušiseinaga.
- Dušisegisti, vihmadušš, vanni täitmistila, käepide.

LISAD



Dušisein 1295.-
(kood: ECL/VES)



Ülevoolust täitmine
(kood: OS) 95.-



Pehme padi
(kood: MSV) 35.-



Automaatne täitmine
(kood: AF) 145.-

Idea 150 (kood: I51 vasak / I52-parem) 150x92x64cm / 177l
Idea 160 (kood: I61-vasak / I62-parem) 160x95x65cm / 203l
Idea 170 (kood: I71-vasak / I72-parem) 170x100x67cm / 236l

SÜSTEEMID	S1	S3	S4	S6	S7	S8	S10	S11
VEEDÜÜSID	-	6+6	6+6	-	6+6	-	-	6+6
ÕHUDÜÜSID	-	-	9	-	9	-	-	-
PUMBAD	-	1	1	-	1	-	-	1
PUHURID	-	-	1	-	1	-	-	-

ESIPANEELI ASETUS

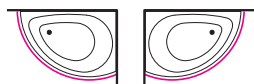

E 16 (vasak) E 15 (parem) E12 paneelideta

MASSAAŽIPAKETID



S1

S3, S5, S11

S4, S7

VANNISEGISTID



Christina
(kood: C1) 295.-



Christina
(kood: C2) 365.-



Christina
(kood: C1Z1) 315.-



Christina
(kood: C2Z1) 385.-

Näidiskood: I72 / S1 / E15 / C1Z1 / OS / MSV /

Koodi selgitus: vanni mudel süsteem esipaneeli asetus vanni segisti ülevoolust täitmine pehme padi

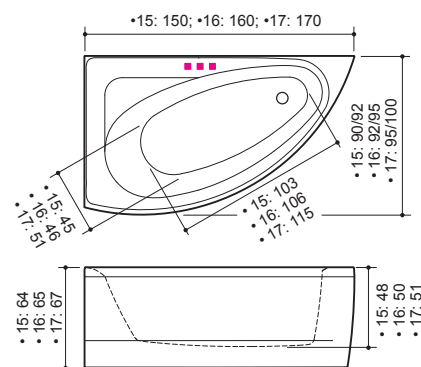

LISAD



Dušisein 615.- (kood: IDE5/VES)
 Dušisein 640.- (kood: IDE6/VES)
 Dušisein 675.- (kood: IDE7/VES)



Ülevoolust täitmine
(kood: OS) 95.-



Pehme padi
(kood: MSV) 35.-



Automaatne täitmine
(kood: AF) 145.-

PS!

- Võimalik komplekteerida toonitud (T2) turv klaasist dušiseinaga.
- Dušisein koosneb liikumatust seinaklaasist ja täielikult sulguvast liuguksest.

Rhea 150 (kood: R51 vasak / R52-parem) 149x100x63cm / 230l
Rhea 160 (kood: R61-vasak / R62-parem) 160x100x67cm / 300l

SÜSTEEMID	S1	S3	S4	S6	S7	S8	S10	S11
VEEDÜÜSID	-	6+8	6+8	-	6+8	-	-	6+8
ÕHUDÜÜSID	-	-	9	-	9	-	-	-
PUMBAD	-	1	1	-	1	-	-	1
PUHURID	-	-	1	-	1	-	-	-

ESIPANEELI ASETUS



E 16 (vasak) E 15 (parem) E12 paneelideta

MASSAAŽIPAKETID

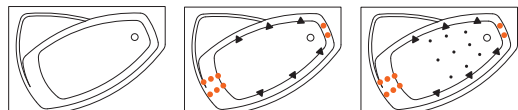

S1

S3, S11

S4, S7

VANNISEGISTID



Damixa Clover
(kood: DC) 567.-



Damixa Jupiter
(kood: DJ1) 515.-



C1 Christina
(kood: C1) 295.-



Christina
(kood: C2) 365.-



Alpi
(kood: A3) 395.-



Christina
(kood: C1Z1) 315.-



C2Z1 Christina
(kood: C2Z1) 385.-

Näidiskood: R52 / S3 / E15 / DC / OS

Koodi selgitus: vanni mudel süsteem esipaneeli asetus vanni segisti ülevoolust täitmine

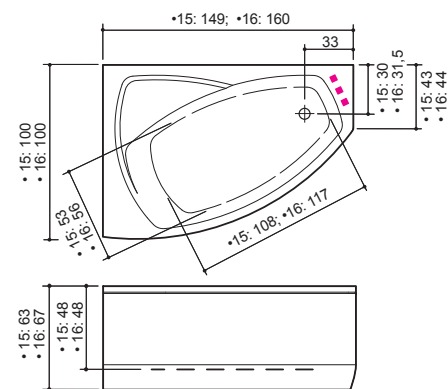

PS!

- Võimalik komplekteerida toonitud (T2) turvaklaasist dušiseinaga.
- Dušiseinaga vannile ei saa paigaldada pakutud segisteid.
- Soovitav on kinnitada segisti vannitoe seinal.

LISAD



Dušisein 345.-
(kood: RHE/VES)



Ülevoolust täitmine
(kood: OS) 95.-



Pehme padi
(kood: MSV) 35.-



Automaatne täitmine
(kood: AF) 145.-

Rhea 17 (kood: RHV vasak / RHP-parem) 169 x 118 x 69 cm / 335

SÜSTEEMID	S1	S3	S4	S6	S7	S8	S10	S11
VEEDÜÜSID	-	6+8	6+8	6+10	6+8	6+10	6+10	6+8
ÕHUDÜÜSID	-	-	9	-	9	9	9	-
PUMBAD	-	1	1	2	1	2	2	1
PUHURID	-	-	1	-	1	1	2	-

ESIPANEELI ASETUS

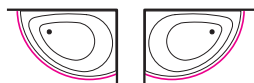

E 16 (vasak) E 15 (parem) E12 paneelideta

MASSAAŽIPAKETID

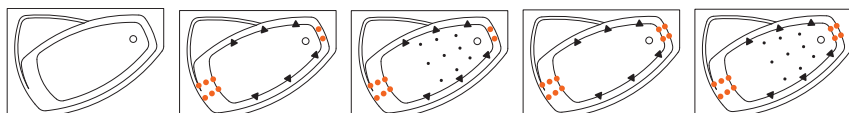

S1

S3, S11

S4, S7

S6

S8, S10

VANNISEGISTID



Damixa Clover
(kood: DC) 567.-



Damixa Jupiter
(kood: DJ1) 515.-



C1 Christina
(kood: C1) 295.-



Christina
(kood: C2) 365.-



Alpi
(kood: A3) 395.-



Christina
(kood: C1Z1) 315.-



C2Z1 Christina
(kood: C2Z1) 385.-

LISAD



Ülevoolust täitmine
(kood: OS) 95.-



Pehme padi
(kood: MSV) 35.-



Automaatne täitmine
(kood: AF) 145.-

Näidiskood: RHV / S6 / E16 / DC / MSV

Koodi selgitus: vanni mudel süsteem esipaneeli asetus vanni segisti pehme padi

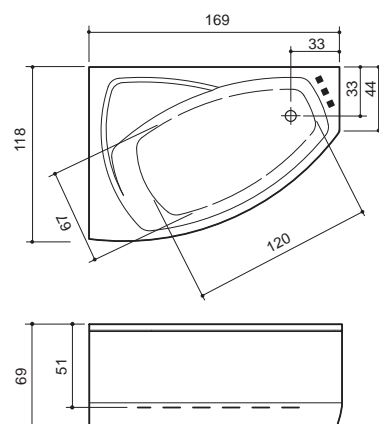

Cali (kood: CLV-vasak / CLP-parem) 170 x 117 x 66 cm / 380 l

Näidiskood: **CLP / S10 / E15 / DC / MSV*2**

Koodi selgitus: vanni mudel süsteem esipaneeli asetus vanni segisti pehme padi 2x

SÜSTEEMID	S1	S3	S4	S6	S7	S8	S10	S11
VEEDÜÜSID	–	8+8	8+8	10+12	8+8	10+12	10+12	8+8
ÕHUDÜÜSID	–	–	10	–	10	10	10	–
PUMBAD	–	1	1	2	1	2	2	1
PUHURID	–	–	1	–	1	1	2	–

ESIPANEELI ASETUS



E 16 (vasak) E 15 (parem) E12 paneelideta

MASSAAŽIPAKETID

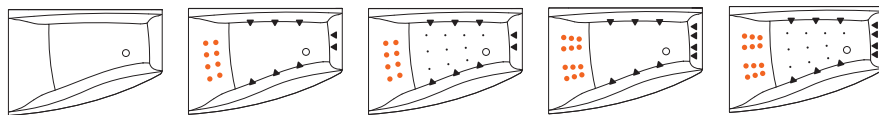

S1

S3, S11

S4, S7

S6

S8, S10

VANNISEGISTID



Damixa Clover
(kood: DC) 567.-



Damixa Jupiter
(kood: DJ1) 515.-



C1 Christina
(kood: C1) 295.-



Christina
(kood: C2) 365.-



Alpi
(kood: A3) 395.-



Christina
(kood: C1Z1) 315.-



C2Z1 Christina
(kood: C2Z1) 385.-

LISAD



Ülevoolust täitmine
(kood: OS) 95.-



Pehme padi
(kood: MSV) 35.-



Automaatne täitmine
(kood: AF) 145.-

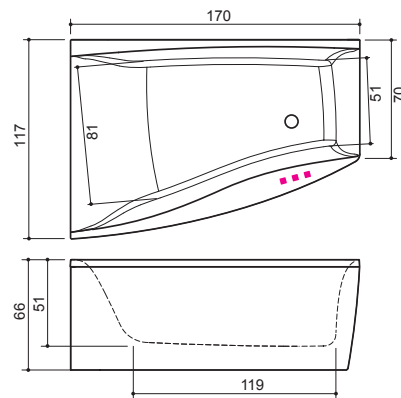

Orion (kood: 071-vasak / 072-parem) 169 x 102 x 66 cm / 300 l

Näidiskood: **O72 / S6 / E15 / DC / MSV**

Koodi selgitus: vanni mudel süsteem esipaneeli asetus vanni segisti pehme padi

SÜSTEEMID	S1	S3	S4	S6	S7	S8	S10	S11
VEEDÜÜSID	–	6+10	6+10	14+20	6+10	14+20	–	6+10
ÕHUDÜÜSID	–	–	10	–	10	10	–	–
PUMBAD	–	1	1	2	1	2	–	1
PUHURID	–	–	1	–	1	1	–	–

ESIPANEELI ASETUS

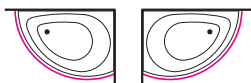

E 16 (vasak) E 15 (parem) E12 paneelideta

MASSAAŽIPAKETID

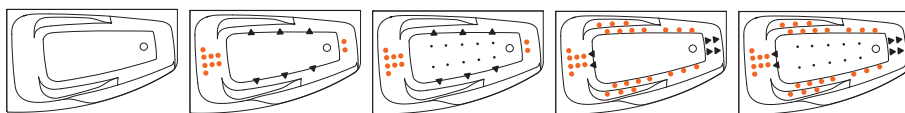

S1

S3, S11

S4, S7

S6

S8

VANNISEGISTID



Christina
(kood: C1) 295.-



Christina
(kood: C2) 365.-



Alpi
(kood: A3) 395.-



Christina
(kood: C1Z1) 315.-



Christina
(kood: C2Z1) 385.-

LISAD



Ülevoolust täitmine
(kood: OS) 95.-



Pehme padi
(kood: MSV) 35.-



Automaatne täitmine
(kood: AF) 145.-

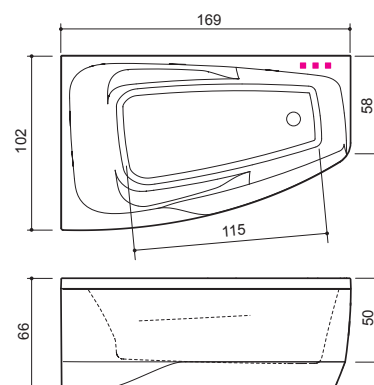

Linea 140 (kood: LI4) 140x140x68cm / 280l

Linea 150 (kood: LI5) 150x150x69cm / 330l

SÜSTEEMID	S1	S3	S4	S6	S7	S8	S10	S11
VEEDÜÜSID	-	6+8	6+8	6+12	6+8	6+12	6+12	6+8
ÕHUDÜÜSID	-	-	10	-	10	10	10	-
PUMBAD	-	1	1	2	1	2	2	1
PUHURID	-	-	1	-	1	1	2	-

ESIPANEELI ASETUS

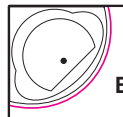

E 17 E12 paneelideta

SELJAMASSAAŽ ÜHE PUMBAGA

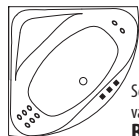

Seljmassaaž vasakul BL

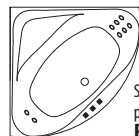

Seljmassaaž paremal BR

MASSAAŽIPAKETID

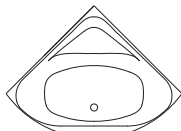

S1

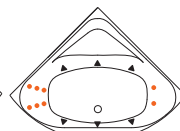

S3, S11

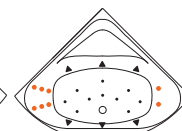

S4, S7

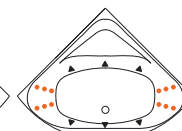

S6

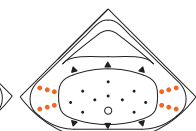

S8, S10

VANNISEGISTID



Damixa Clover (kood: DC) 567.-



Damixa Jupiter (kood: DJ) 515.-



C1 Christina (kood: C1) 295.-



Christina (kood: C2) 365.-



Alpi (kood: A3) 395.-



Christina (kood: C1Z1) 315.-



C2Z1 Christina (kood: C2Z1) 385.-

LISAD



Ülevoolust täitmine (kood: OS) 95.-



Pehme padi (kood: MSV) 35.-



Automaatne täitmine (kood: AF) 145.-

Näidiskood: LI4 / S6 / E12 / DC / MSV

Koodi selgitus: vanni mudel süsteem esipaneeli asetus vanni segisti pehme padi

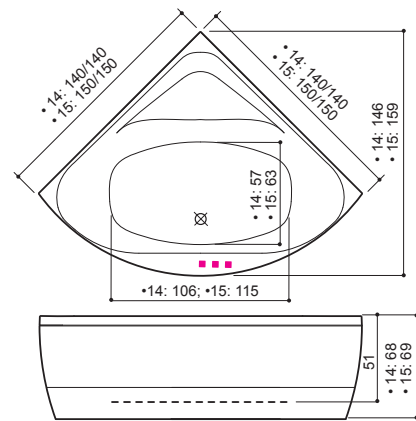

PS!

• Võimalik komplekteerida toonitud (T2) turvaklaasist dušiseinaga. Dušisein koosneb liikumatust seinaklaasist ja täielikult sulguvast liuguksest.



Dušisein 710.- (kood: LI4/VES)
Dušisein 745.- (kood: LI5/VES)

Metro (kood: MET) 155 x 155 x 64 cm / 430l

SÜSTEEMID	S1	S3	S4	S6	S7	S8	S10	S11
VEEDÜÜSID	-	6+5	6+5	10+10	6+5	10+10	10+10	-
ÕHUDÜÜSID	-	-	13	-	13	13	13	-
PUMBAD	-	1	1	2	1	2	2	-
PUHURID	-	-	1	-	1	1	2	-

ESIPANEELI ASETUS

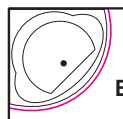

E 17 E12 paneelideta

SELJAMASSAAŽ ÜHE PUMBAGA

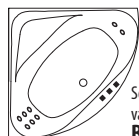

Seljmassaaž vasakul BL

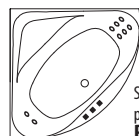

Seljmassaaž paremal BR

MASSAAŽIPAKETID

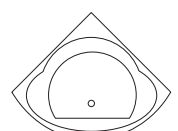

S1



S3



S4, S9

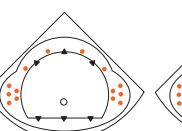

S6



S8, S10

VANNISEGISTID



Damixa Clover (kood: DC) 567.-



Damixa Jupiter (kood: DJ) 515.-



Alpi (kood: A3) 395.-

LISAD



Ülevoolust täitmine (kood: OS) 95.-



Automaatne täitmine (kood: AF) 145.-



Pehme padi (kood: MSV) 35.-

Näidiskood: MET / S8 / E17 / DC / MSV*2

Koodi selgitus: vanni mudel süsteem esipaneeli asetus vanni segisti pehme padi 2x

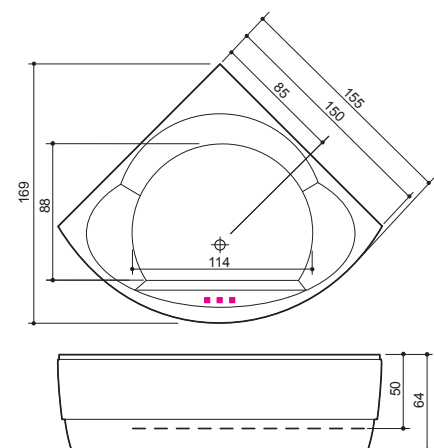

Scala (kood: SCA) 180 x 120 x 67 cm / 535 l

SÜSTEEMID	S1	S3	S4	S6	S7	S8	S10	S11
VEEDÜÜSID	-	8	8	8+20	8	8+20	-	-
ÕHUDÜÜSID	-	-	16	-	16	16	-	-
PUMBAD	-	1	1	2	1	2	-	-
PUHURID	-	-	1	-	1	1	-	-

ESIPANEELI ASETUS

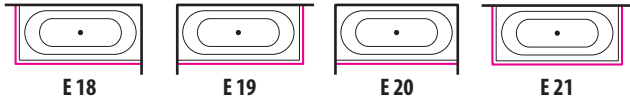

PS!
• E 21 puhul lisandub otsapaneeli hind: 45eur.

E 24 paneelideta

MASSAAŽIPAKETID

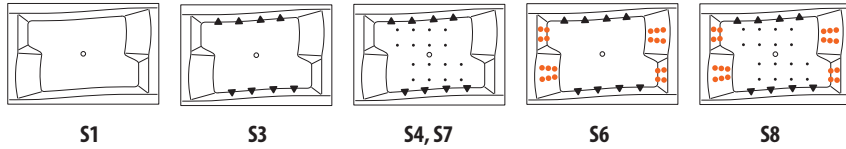

VANNISEGISTID



LISAD



VÕIMALIKUD SEGISTI ASETUSED VANNI ÄÄREL

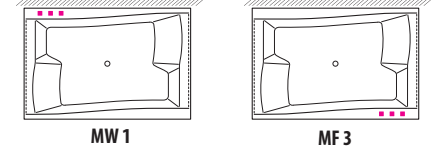

Näidiskood: SCA / S9 / E21 / DC / MSV*2
Koodi selgitus: vanni mudel süsteem esipaneeli asetus vanni segisti pehme padi

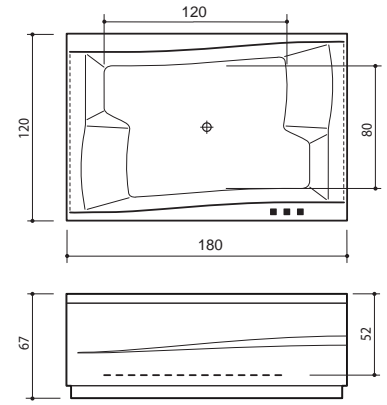

Madonna (kood: MXL) Ø 173 x 73 cm / 475 l

SÜSTEEMID	S1	S3	S4	S6	S7	S8	S10	S11
VEEDÜÜSID	-	-	-	12+12	12+12	12+12	12+12	-
ÕHUDÜÜSID	-	-	-	-	12	12	12	-
PUMBAD	-	-	-	2	1	2	2	-
PUHURID	-	-	-	-	1	1	2	-

ESIPANEELI ASETUS



PS!
• Veekahur Grand on standardvarustuses.



MASSAAŽIPAKETID

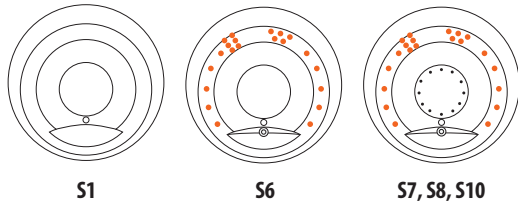

VANNISEGISTID



LISAD



Näidiskood: MXL / S10 / E24 / DC / MSV*2
Koodi selgitus: vanni mudel süsteem esipaneeli asetus vanni segisti pehme padi 2x

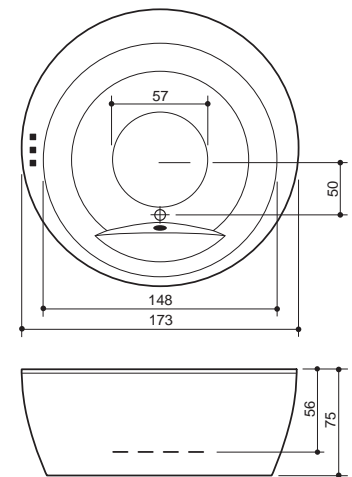

Quadrum (kood: QDR) 178 x 178 x 72 cm / 600 l

Näidiskood: QDR / S6 / DR1 /

Koodi selgitus: vanni mudel süsteem vanni segisti

SÜSTEEMID	S1	S3	S4	S6	S7	S8	S10	S11
VEEDÜÜSID	-	-	-	6+22+2	-	6+22+2	-	-
ÕHUDÜÜSID	-	-	-	-	-	12	-	-
PUMBAD	-	-	-	2	-	2	-	-
PUHURID	-	-	-	-	-	1	-	-

MASSAAŽIPAKETID

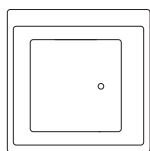

S1

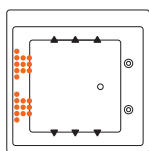

S6

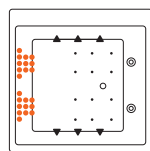

S8

PS!

• Veekahur Grand on standardvarustuses.



Veekahur Grand

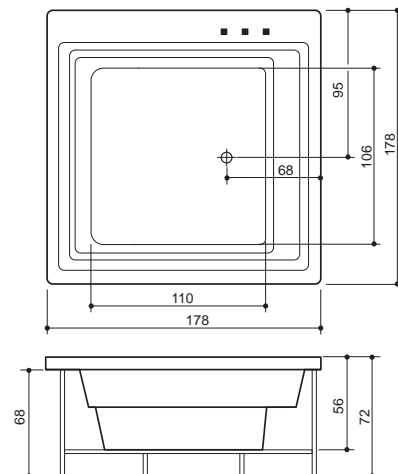

VANNISEGISTID



Damixa Clover
(kood: DC) 758.-



Damixa Jupiter
(kood: DJ) 515.-



Alpi
(kood: A3) 602.-

LISAD



Ülevoolust täitmine
(kood: OS) 95.-



Automaatne täitmine
(kood: AF) 145.-



Pehme padi
(kood: MSV) 35.-

PS!

• Quadrum on saadaval ainult uputatava vannina - ilma dekoratiivsete küljepaneelideta.

MIO XONYX™

DUŠIPANEEL

33 x 149 x 24 cm

- Kvaliteetne dušisegisti
- Vihmadušš
- Minimalistlik käsidušš
- Veemassaaži düüsid 3 erineva pihustiga
- Varjatud riulid

PS.

Võimalik tellida värve ka RAL süsteemi alusel.

Standartne värvivalik:



Must
9011



Punane
3032



Valge
(vaikimisi)

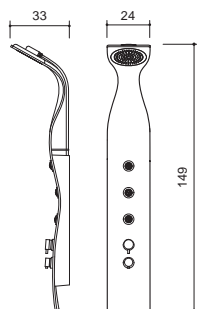

DUŠIRUUMI ISTE

325 x 350 x 113 cm

- Üles/alla klapitav
- Vannitoe seinale monteeritav
- Kvaliteetne viimistlus ja vastupidav konstruktsioon
- Veekindel materjal
- Maks. kasutaja kaal: 120 kg

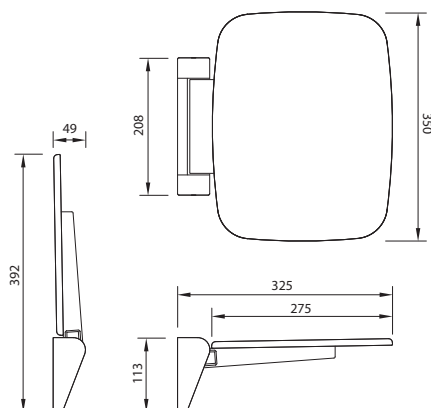



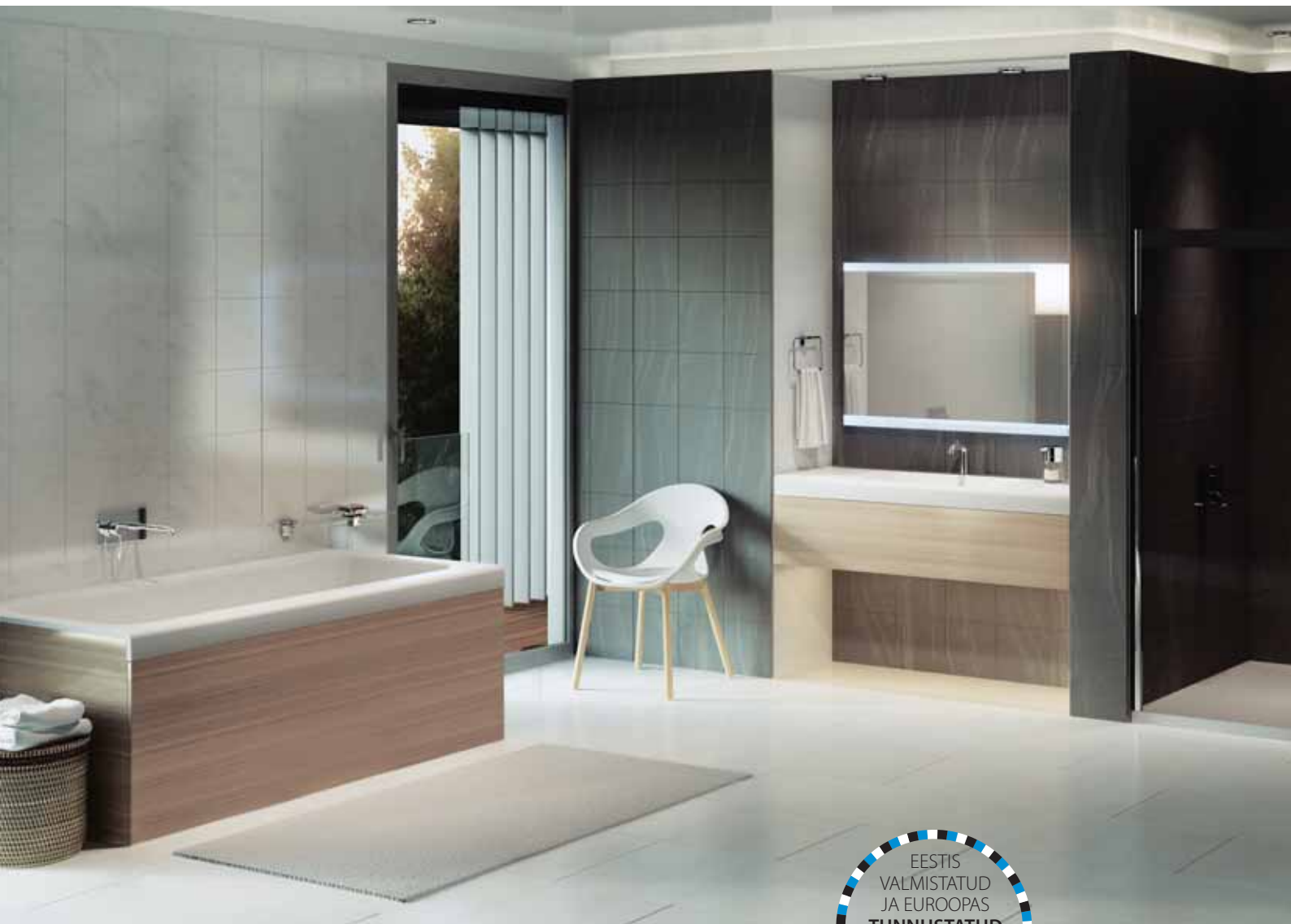

BALTECO

Tallinna salong:
Mustamäe tee 44
tel: 667 1766; 667 1760
salong@balteco.ee

Tartu salong:
Tehase 16, Sisustus E-Kaubamaja
tel: 730 8416
salong.tartu@balteco.ee