

- 170 x 72 x 63 cm
- 250 l

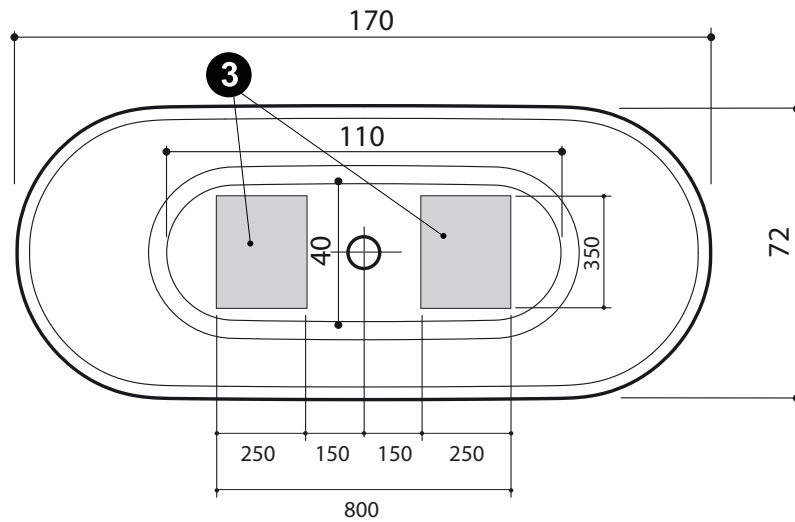

ENG ③ Sewage opening D=50mm.

FIN ③ Viemäristöaukko D=50 mm.