

Kasai A 70
Art.No. 7010141

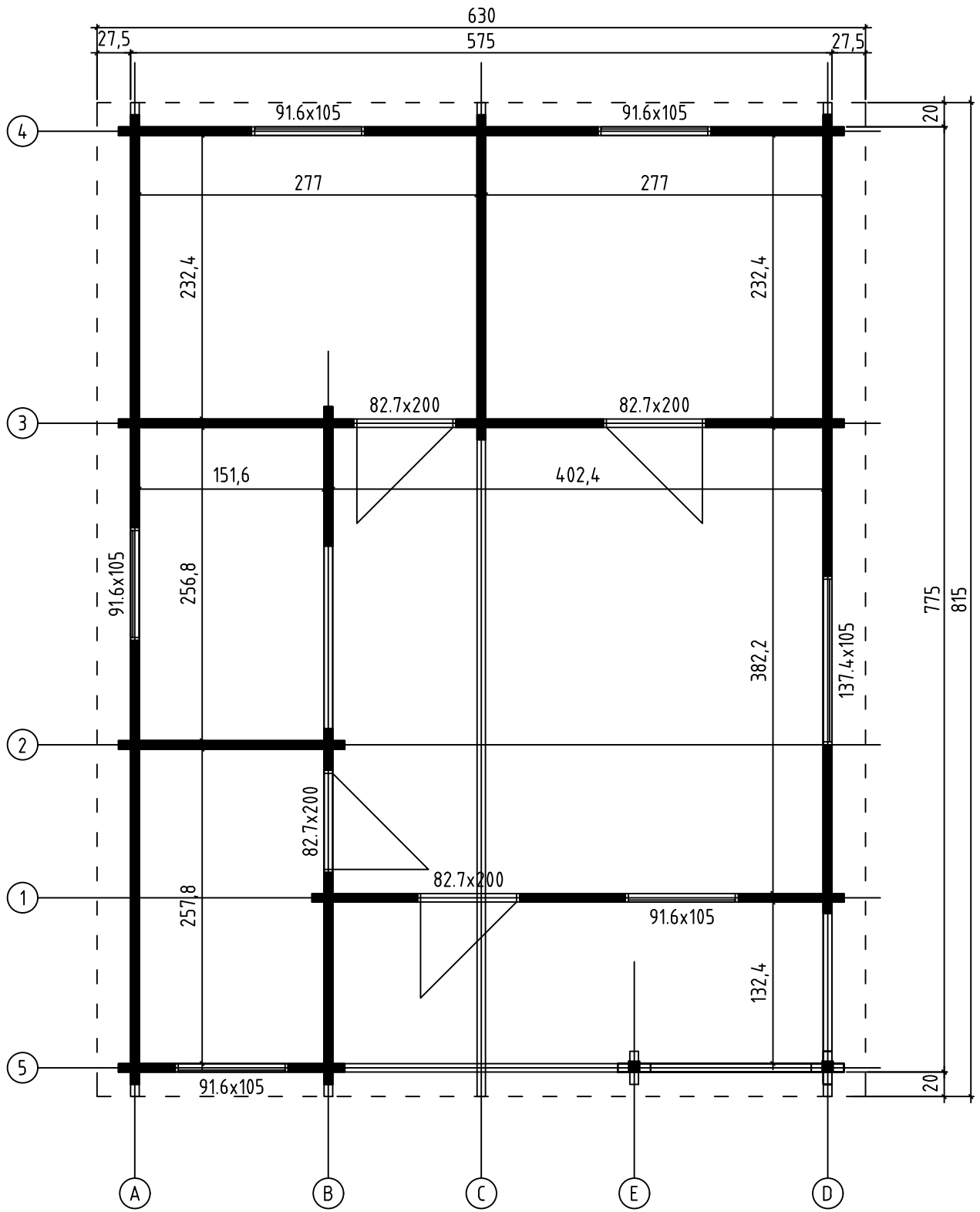

Kasai A 70, Art.No.7010141
GROUNDPLAN - GRUNDPLAN - PLAN DE MASSE



Kasai A 70, Art.No.7010141
FLOOR BOARDS - FUSSBODENBRETTER - PLAN POSE PLANCHER

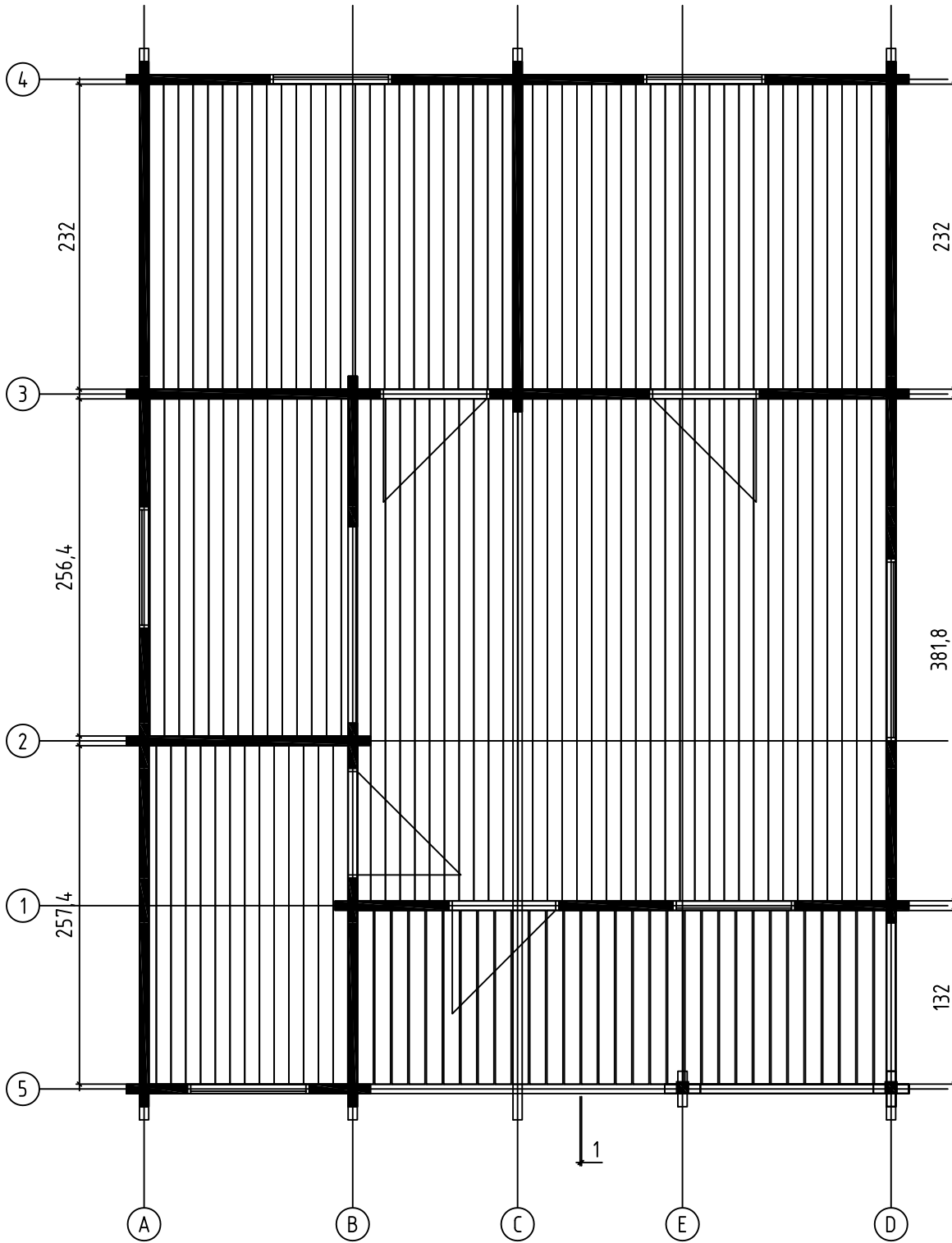

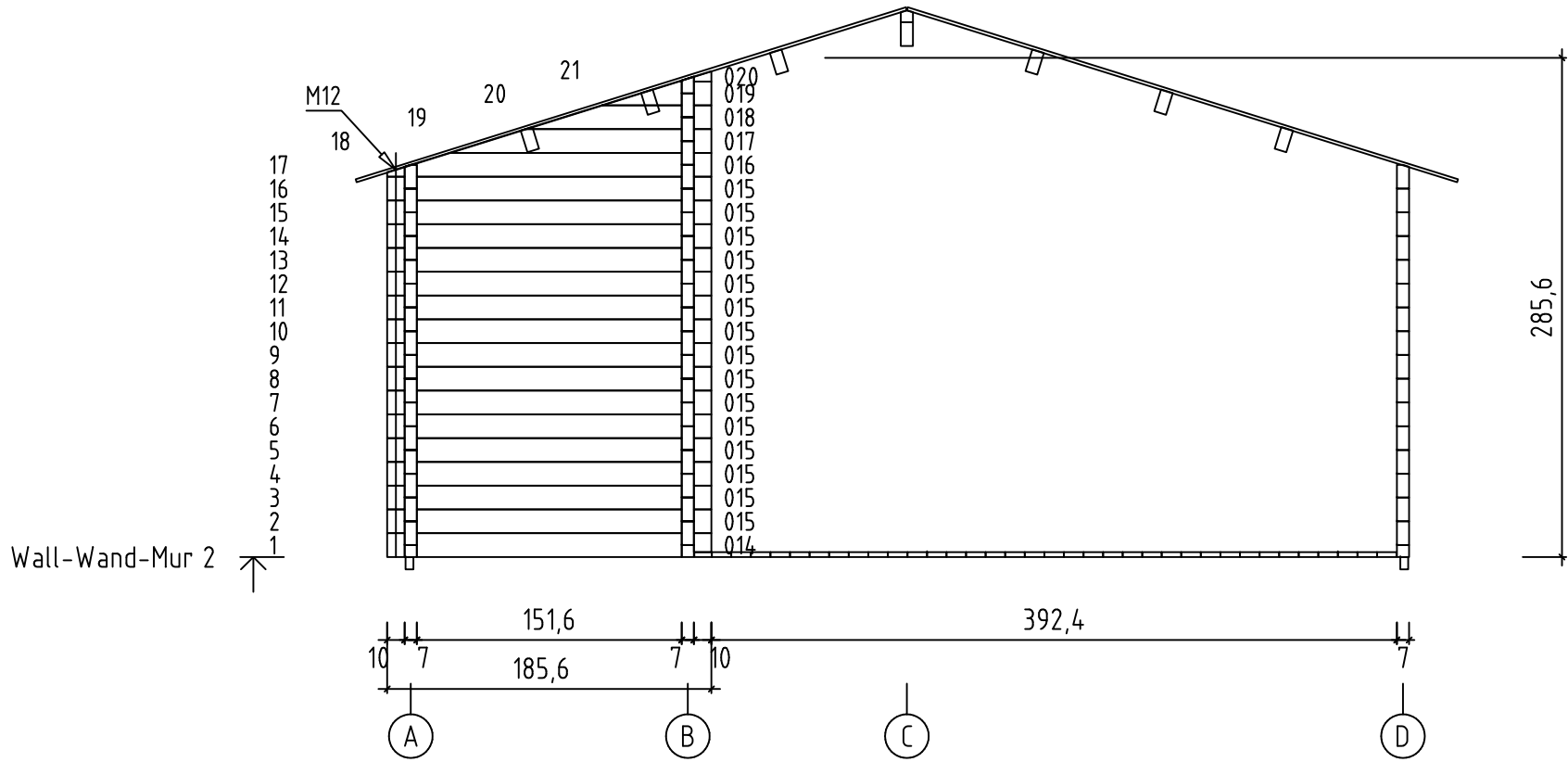

Kasai A 70, Art.No.7010141

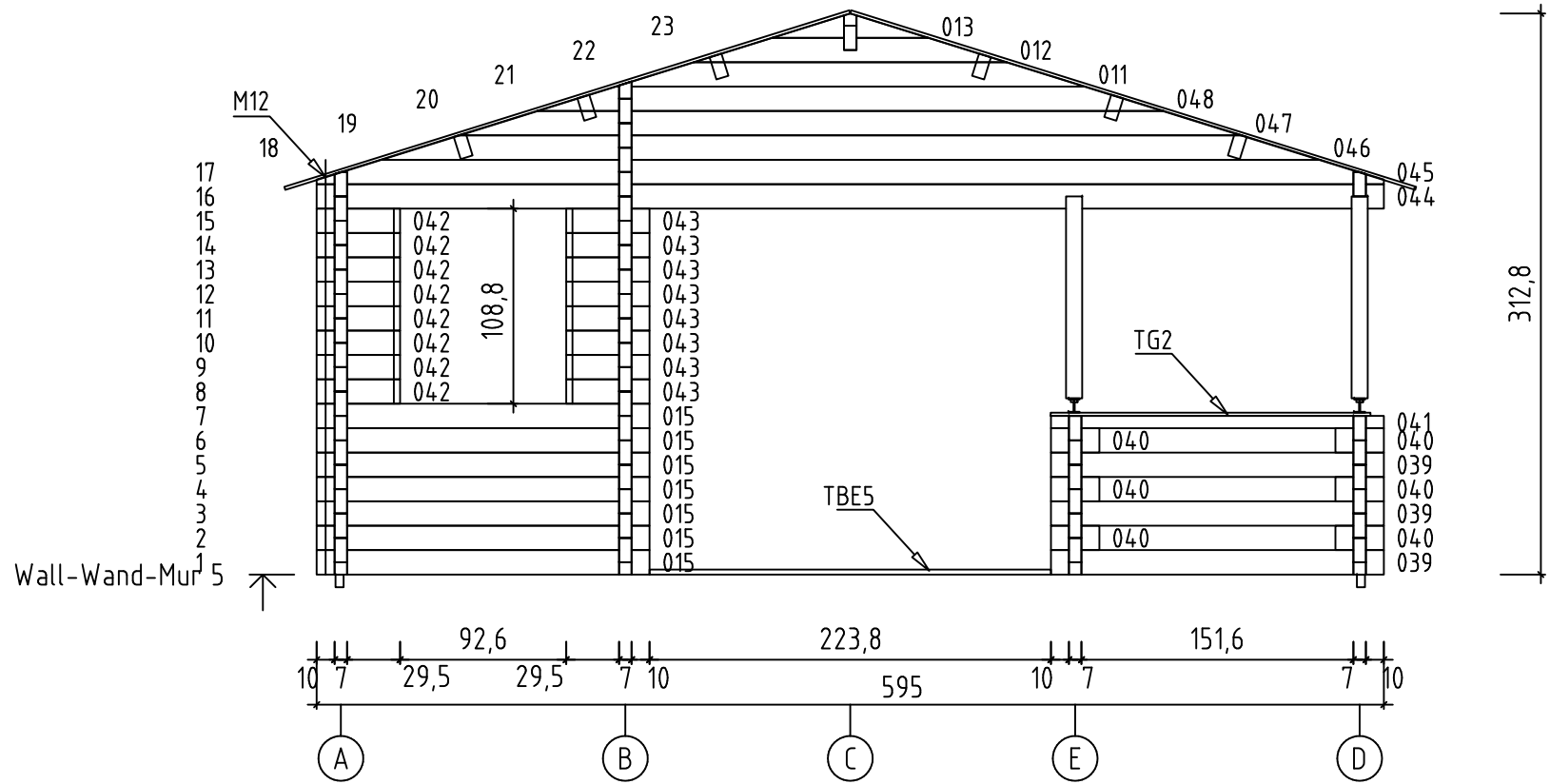

Kasai A 70, Art.No.7010141

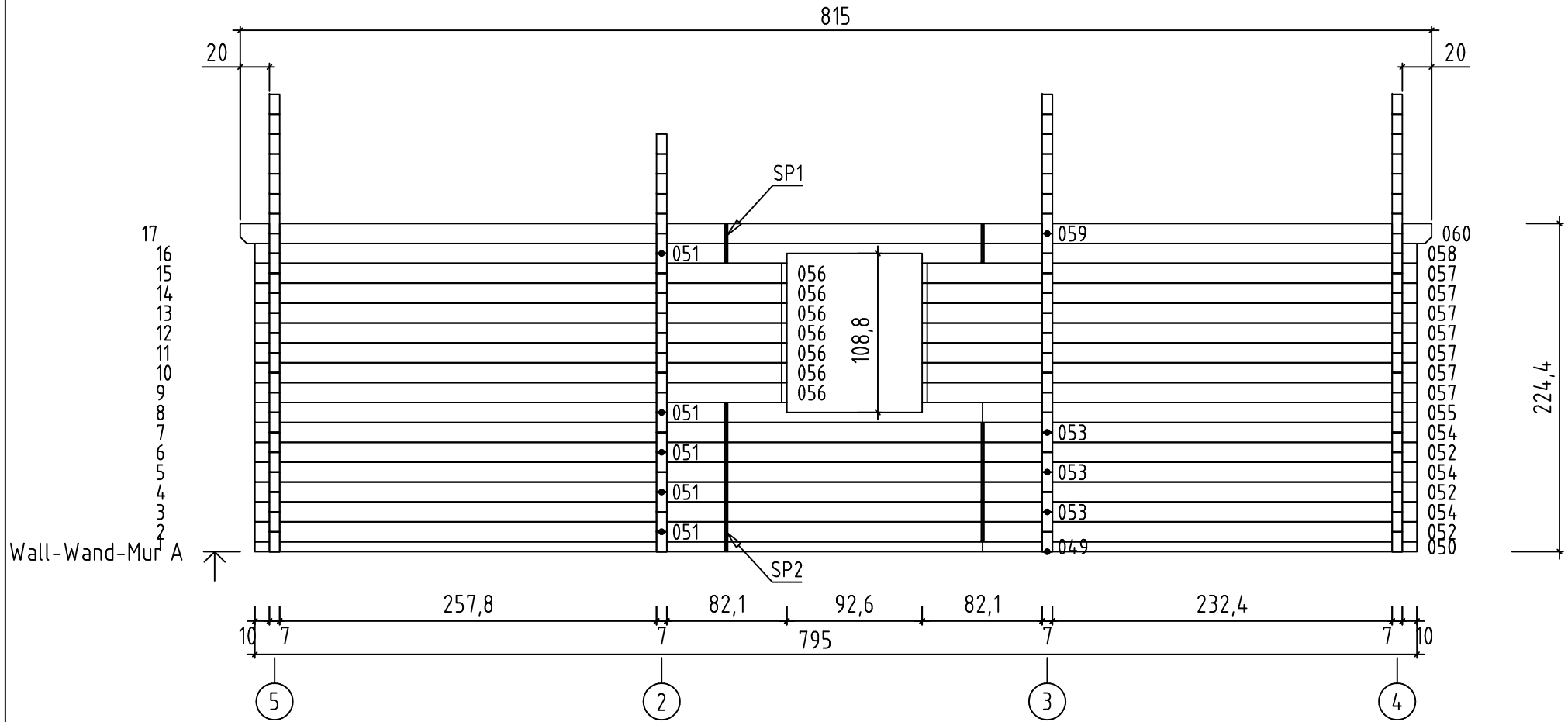

Kasai A 70, Art.No.7010141

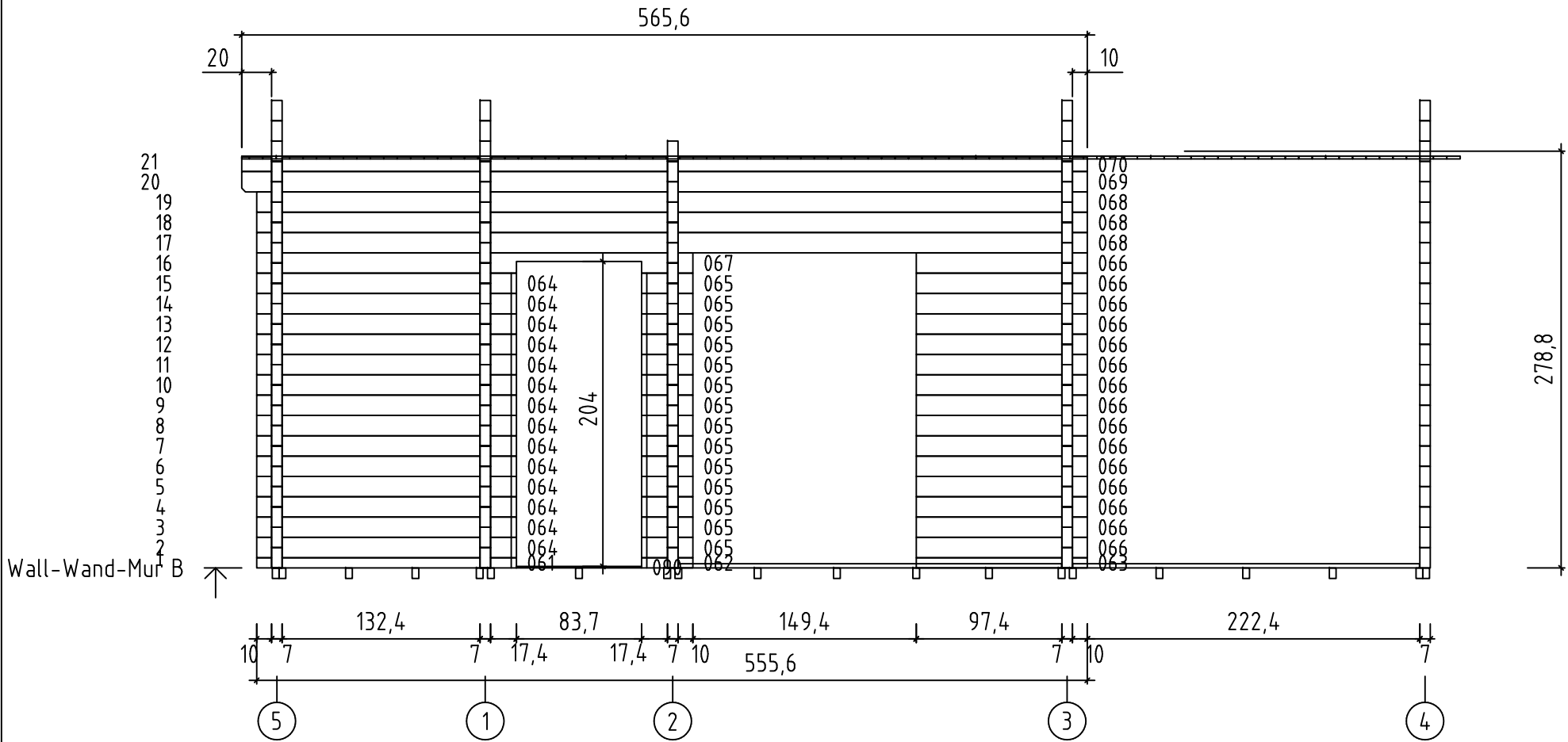



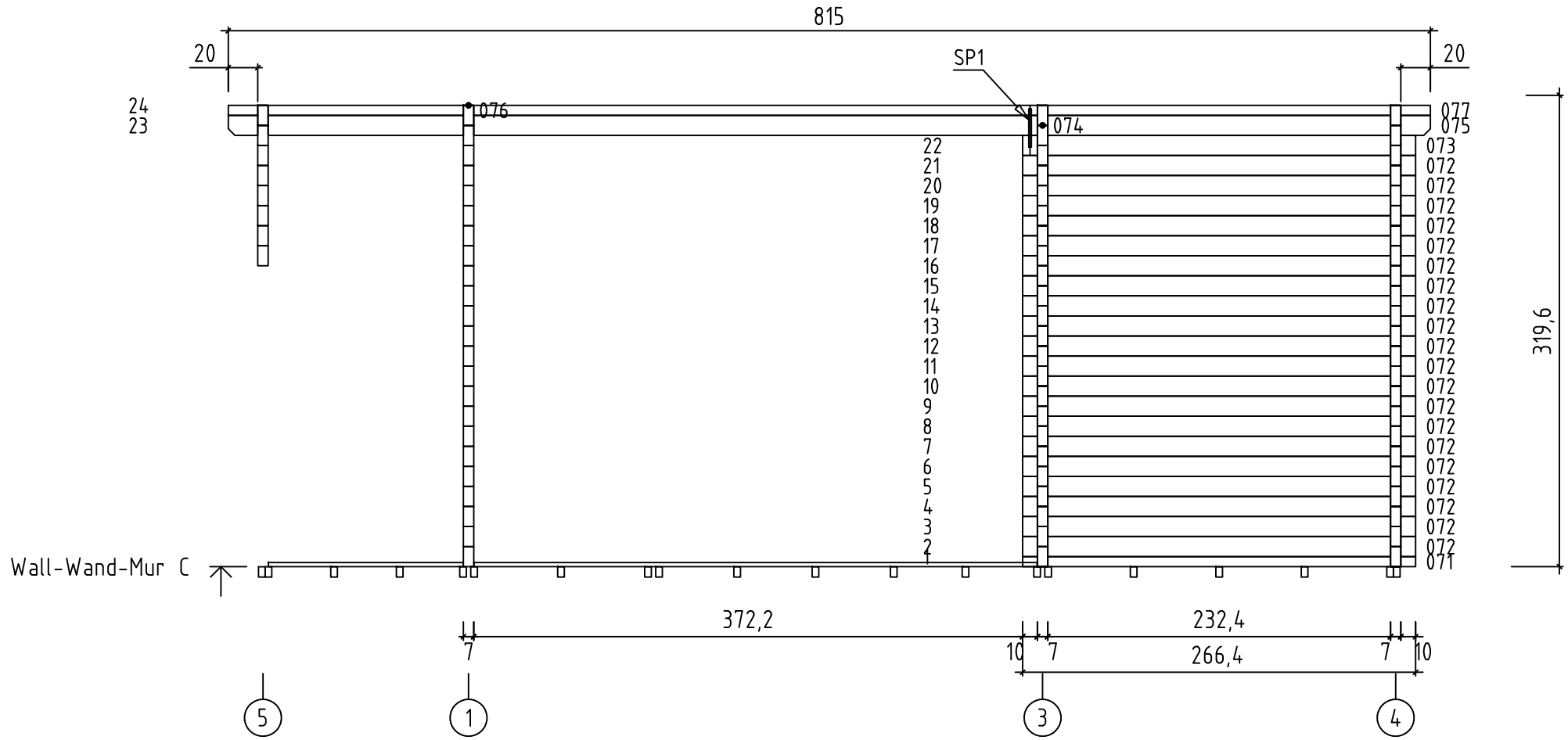

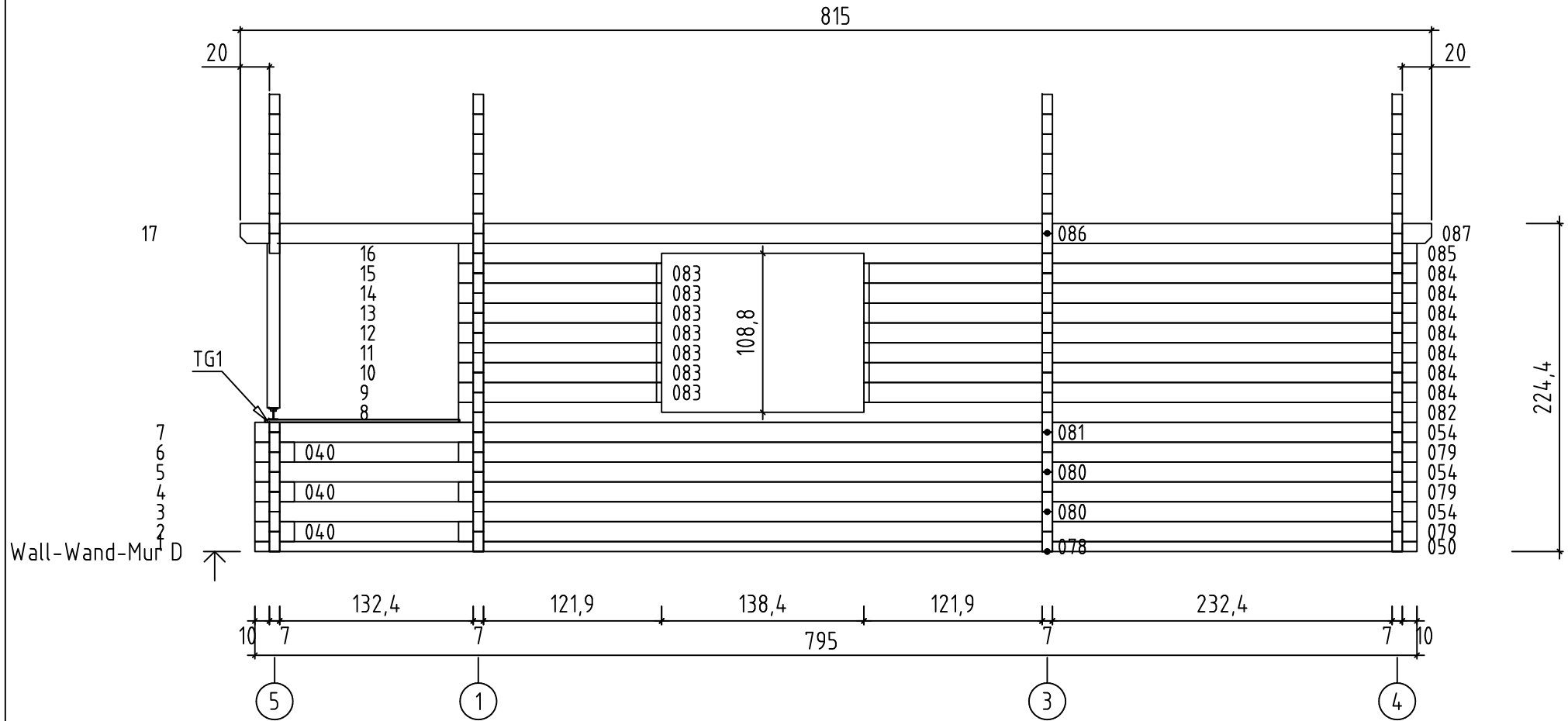

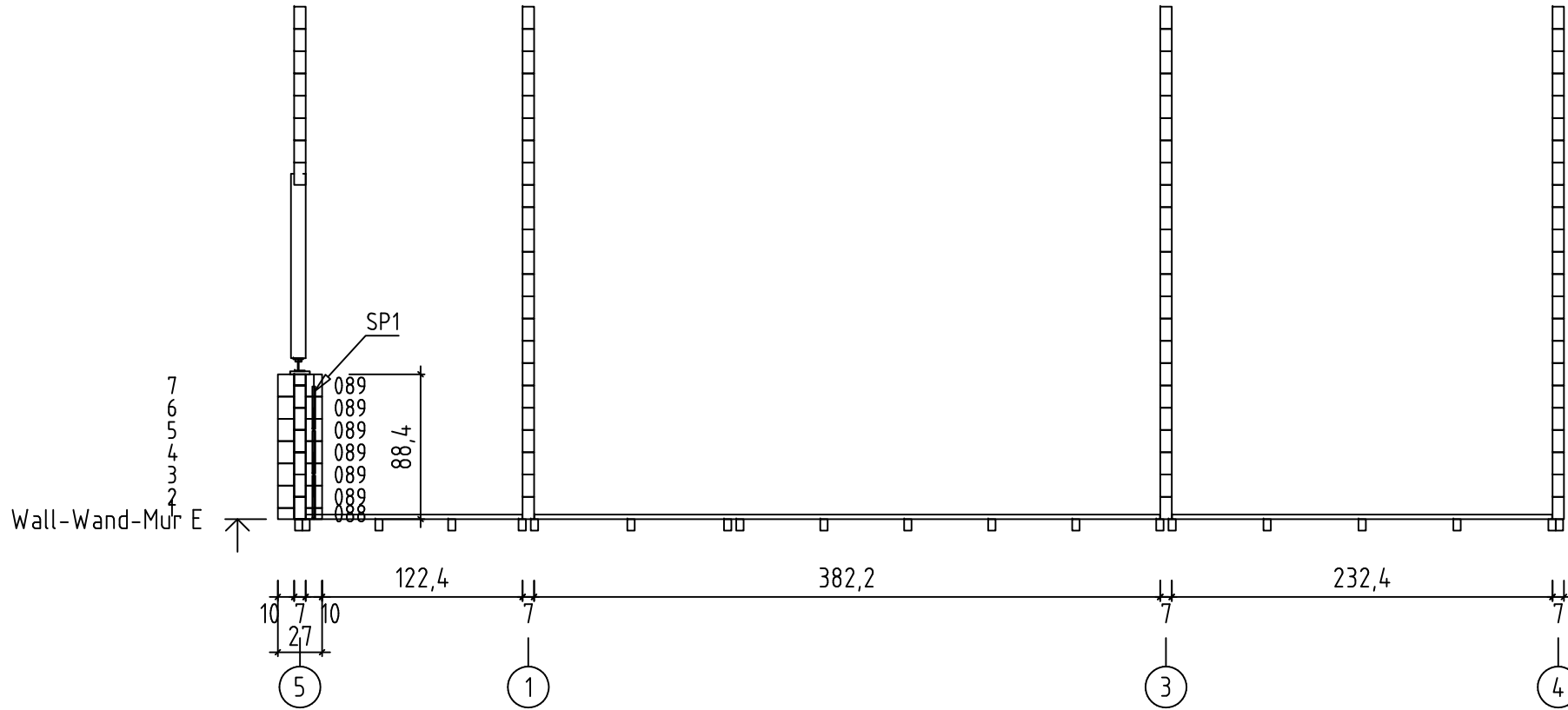

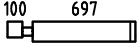
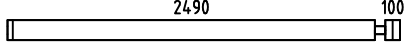
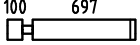
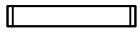
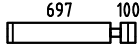
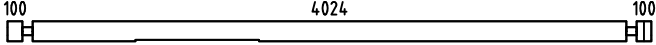
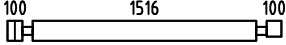
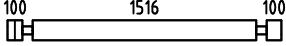
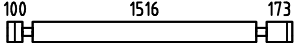
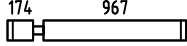
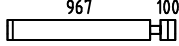
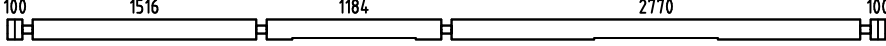
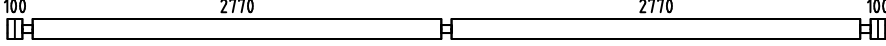
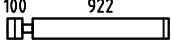
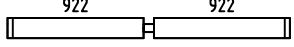
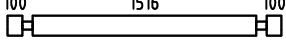
Kasai A 70, Art.No.7010141

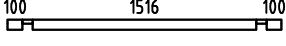

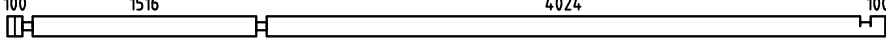
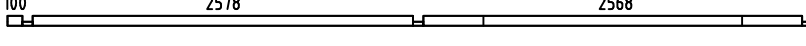
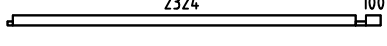
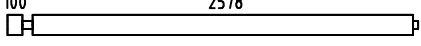
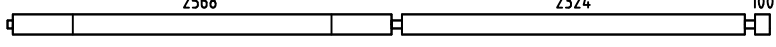

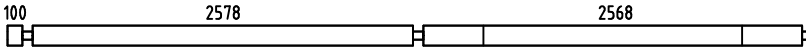
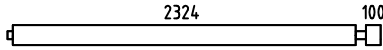
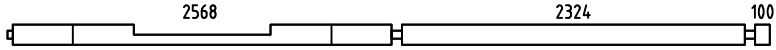
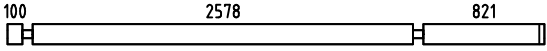
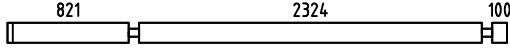
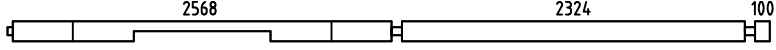
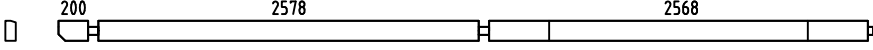
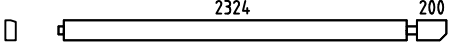
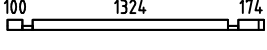

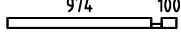
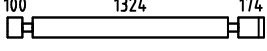

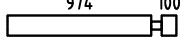
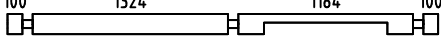
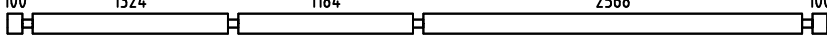
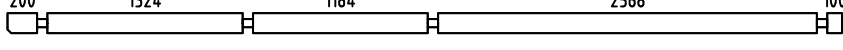
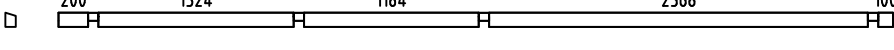
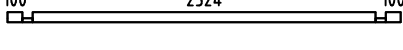
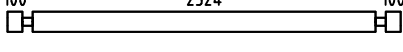
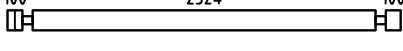
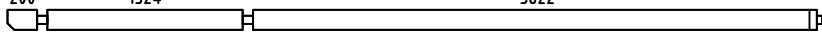
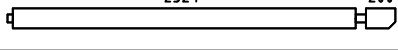
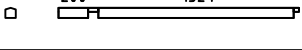
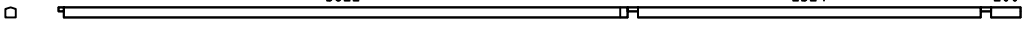

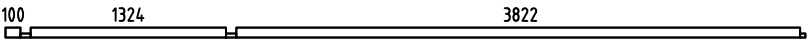
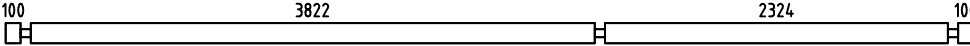
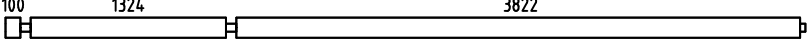
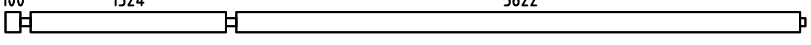
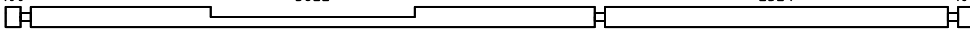
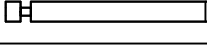
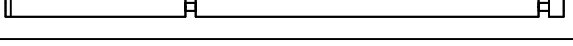
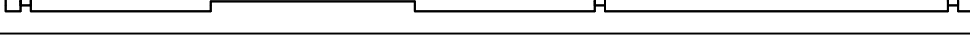
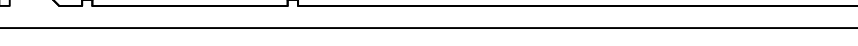
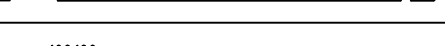



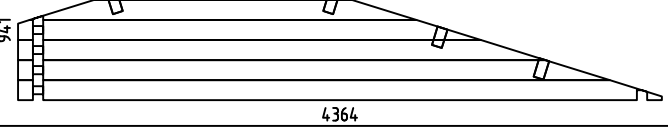
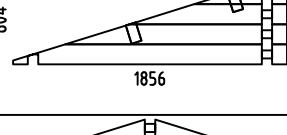
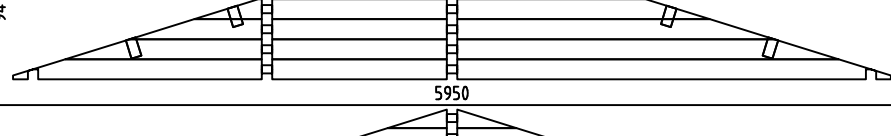
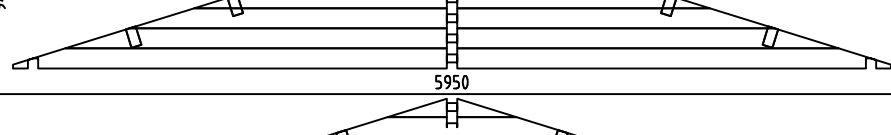
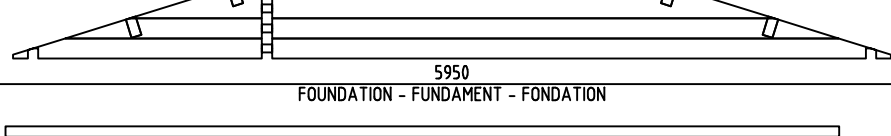
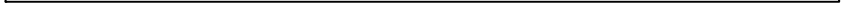

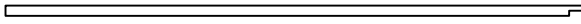
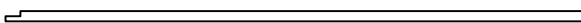

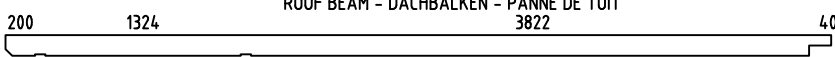
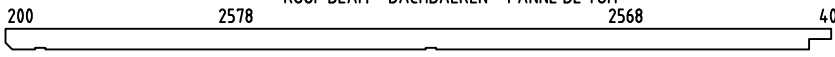
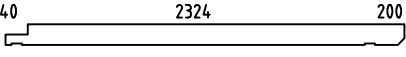
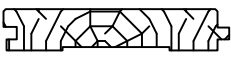
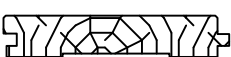

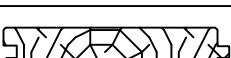











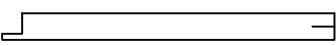
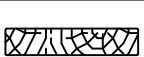







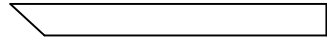
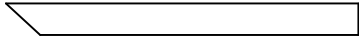
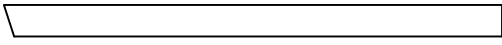





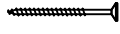

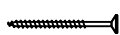









Pos	Kasai A 70, Art.No.7010141 Piece list - Stückliste - Liste des pieces	Q.	P (mm)	L (mm)
001		1	70x136	867
002		7	70x136	2660
003		14	70x136	867
004		8	70x136	867
005		8	70x136	867
006		1	70x136	4364
014		1	70x136	1856
015		22	70x136	1856
021		15	70x136	1930
022		15	70x136	1210
023		15	70x136	1137
024		1	70x136	5950
031		8	70x136	5950
032		16	70x136	1092
033		8	70x136	1914
039		3	70x136	1856
040		9	70x136	270
041		1	70x68	1856
042		8	70x136	465
043		8	70x136	465
044		1	70x136	5950
049		1	70x68	5421
050		2	70x68	2529
051		5	70x136	2783
052		3	70x136	5167

Pos	Kasai A 70, Art.No.7010141 Piece list - Stückliste - Liste des pieces	Q.	P (mm)	L (mm)
053		3	70x136	5421
054		6	70x136	2529
055		1	70x136	5167
056		7	70x136	3639
057		7	70x136	3385
058		1	70x136	5167
059		1	70x136	5521
060		1	70x136	2629
061		1	70x68	1738
062		1	70x68	344
063		1	70x68	1144
064		14	70x136	1738
065		14	70x136	344
066		15	70x136	1144
067		1	70x136	2918
068		3	70x136	5556
069		1	70x136	5656
070		1	70x97	5656
071		1	70x68	2664
072		20	70x136	2664
073		1	70x136	2664
074		1	70x136	5521
075		1	70x136	2629
076		1	70x68	1629
077		1	70x68	6521

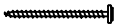
Pos	Kasai A 70, Art.No.7010141 Piece list - Stückliste - Liste des pieces	Q.	P (mm)	L (mm)
078		1	70x68	5421
079		3	70x136	6556
080		2	70x136	5421
081		1	70x136	5421
082		1	70x136	6556
083		7	70x136	1389
084		7	70x136	3783
085		1	70x136	6556
086		1	70x136	5521
087		1	70x136	2629
088		1	70x68	270
089		5	70x136	270
090		1	70x136	270
091		4	70x10	837
W1-1		1		
W2-1		1		
W3-1		1		
W4-1		1		
W5-1		1		
IAR4	FOUNDATION - FUNDAMENT - FONDATION 	20	45x70	5650

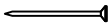
Pos	Kasai A 70, Art.No.7010141 Piece list - Stückliste - Liste des pieces	Q.	P (mm)	L (mm)
IAR1	FOUNDATION - FUNDAMENT - FONDATION 	2	45x70	3920
IAR2	FOUNDATION - FUNDAMENT - FONDATION 	2	45x70	3920
IAR3	FOUNDATION - FUNDAMENT - FONDATION 	2	45x70	544
A-PR3	ROOF BEAM - DACHBALKEN - PANNE DE TOIT 200 1324 3822 40 	4	70x140	5596
A-PR1	ROOF BEAM - DACHBALKEN - PANNE DE TOIT 200 2578 2568 40 	2	70x140	5596
A-PR2	ROOF BEAM - DACHBALKEN - PANNE DE TOIT 40 2324 200 	6	70x140	2704
PTL	FLOOR BOARDS - FUSSBODENBRETTER - LAME DE PLANCHER 	36	112x28	3818
PTL	FLOOR BOARDS - FUSSBODENBRETTER - LAME DE PLANCHER 	14	112x28	2574
PTL	FLOOR BOARDS - FUSSBODENBRETTER - LAME DE PLANCHER 	15	112x28	2564
PTL	FLOOR BOARDS - FUSSBODENBRETTER - LAME DE PLANCHER 	50	112x28	2320
	ROOF BOARDS - DACHBRETTER - VOLIGES 	182	90x18	3300
SV2	TERRACE BOARDS - TERRASSENBRETTER - PLANCHER DE TERRASSE 	31	120x28	1320
FL	FLOOR FILLET-FUSSBODENLEISTE - CORNIERE DE FINITION DU PLANCHER 		14x40	47.6 m.
DPL	ROOFING FELT FILLET - DACHPAPPENLEISTE - BAGUETTE DE FIXATION DU FEUTRE BITUMEUX 	4	18x58	3350
M12	TREADED ROD M12 - GEWINDESTANGE M12 TIGE FILETÉE M12 	7		245
M12	TREADED ROD M12 - GEWINDESTANGE M12 TIGE FILETÉE M12 	7		2000
TBE5	TERRACE EDGE BOARD - TERRASSENBRETT, EINGANG - LAME DE SEUIL D'ENTREE DE TERRASSE 	1	28x70	2238
LPL	FIXING FILLET - FIXIRUNGSLEISTE - PROFIL DE FIXATION 	4	20x70	787
LPL	FIXING FILLET - FIXIRUNGSLEISTE - PROFIL DE FIXATION 	10	20x70	876
LPL	FIXING FILLET - FIXIRUNGSLEISTE - PROFIL DE FIXATION 	12	20x70	1050
LPL	FIXING FILLET - FIXIRUNGSLEISTE - PROFIL DE FIXATION 	2	20x70	1334
LPL	FIXING FILLET - FIXIRUNGSLEISTE - PROFIL DE FIXATION 	8	20x70	2000
P	POST - PFOSTEN - POTEAU 	2	90x90	1126
TB	EAVES BOARD - TRAUFBRETT - BANDEAU DE TOIT 	4	18x90	4075
DRV	ROOF EDGE REINFORCEMENT - DACHRANDVERSTÄRKUNG - CORNIERE DE RENFORT DE BORD DE TOIT 	4	28x34	4075

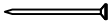
Pos	Kasai A 70, Art.No.7010141 Piece list - Stückliste - Liste des pieces	Q.	P (mm)	L (mm)	
TBE6	FIXING FILLET FOR WINDOW - FIXIRUNGSLEISTE FÜR FENSTER - PROFIL DE FIXATION DES FENETRES		4	28x34	884
TBE6	FIXING FILLET FOR WINDOW - FIXIRUNGSLEISTE FÜR FENSTER - PROFIL DE FIXATION DES FENETRES		8	28x34	1050
TBE6	FIXING FILLET FOR DOOR - FIXIRUNGSLEISTE FÜR TÜR - PROFIL DE FIXATION DES PORTES		2	28x34	1894
TBE6	FIXING FILLET FOR DOOR - FIXIRUNGSLEISTE FÜR TÜR - PROFIL DE FIXATION DES PORTES		6	28x34	1990
TG1	GUARD-RAIL FOR TERRACE - TERRASSENGELÄNDER - MAIN COURANTE DE TERRASSE		1	18x120	1325
TG2	GUARD-RAIL FOR TERRACE - TERRASSENGELÄNDER - MAIN COURANTE DE TERRASSE		1	18x120	1783
GL	GABLE MOULDING - GIEBELLEISTE PLANCHE DE RIVE		4	18x120	3350
KL4	LENGTHENING BOLT FOR TREADED ROD - VERLÄNGERUNGSMUTTER FÜR GEWINDESTANGE - MANCHON DE RACCORDEMENT DE TIGE FILETÉE		7		
KL1	DRIVE NUT TREADED ROD - EINSHLAGMUTTER FÜR GEWINDESTANGE - ÉCROU A FRAPPER POUR TIGE FILITÉE		7		
KL2	NUT FOR TREADED ROD - MUTTER FÜR GEWINDESTANGE - ÉCROU POUR TIGE FILETÉE		7		
KL3	PLAIN WASHER TREADED ROD - UNTERLEGSSCHEIBE FÜR GEWINDESTANGE - RONDELLE PLATE POUR TIGE FILETÉE		7		
HS12	SCREW FOR GABLE SEGMENT - SCHRAUBEN FÜR DECKBLATT - VIS POUR FIXATION LOSANGE DE FINITION		4	3.5x35	
HS83	SCREW FOR FIXING FILLET - SCHRAUBEN FÜR FIXIRUNGSLEISTE - VIS POUR PROFIL DE FIXATION		154	3.5x50	
HS84	SCREW FOR FIXING FILLET - SCHRAUBEN FÜR FIXIRUNGSLEISTE - VIS POUR PROFIL DE FIXATION		88	3.5x50	
HS16	SCREW FOR GABLE MOULDING - SCHRAUBEN FÜR GIEBELLEISTE - VIS DE FIXATION POUR PLANCHE DE RIVE		40	3.5x50	
HS32	SCREW FOR EAVES BOARDS - SCHRAUBEN FÜR TRAUFBRETT - VIS DE FIXATION POUR BANDEAU DE TOIT		36	4x40	
HS26	SCREW FOR ROOF EDGE REINFORCEMENT - SCHRAUBEN FÜR DACHRANDVERSTÄRKUNG - VIS POUR RENFORT DE BORD DE TOIT		36	4x40	
HS30	SCREW FOR TERRACE REAR BOARDS - SCHRAUBEN FÜR TERRASSENRAND - VIS DE FIXATION POUR MAIN COURANTE DE TERRASSE		9	4x40	
HS34	SCREW FOR POST - SCHRAUBEN FÜR PFOSTEN - VIS DE FIXATION DES POTEAUX		4	4x60	
NF3	SCREW FOR TERRACE BOARD (TBE5) - SCHRAUBE FÜR TERRASSENBRETT - VIS POUR LAME DE SEUIL D'ENTREE DE TERRASSE (TBE5)		5	4x60	
HS40	SCREW FOR 1. WALL BEAM - SCHRAUBE FÜR 1. BOHLENREIHE - VIS DE FIXATION DES FONDATIONS		26	5x120	
HS42	SCREW FOR GABLE - SCHRAUBEN FÜR GIEBEL - VIS POUR FIXATION DES PIGNONS		49	5x120	
HS43	SCREW FOR ROOF BEAMS - SCHRAUBEN FÜR DACHBALKEN - VIS POUR PANNE DE TOIT		36	5x120	
HS78	SCREW FOR Pos.041 - SCHRAUBEN FÜR Pos.041 - VIS POUR Pos.041		3	5x120	
HS39	SCREW FOR FUNDAMENT - SCHRAUBEN ZUR BEFESTIGUNG FUNDAMENT - VIS POUR FONDATION		58	5x90	

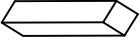
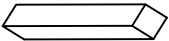
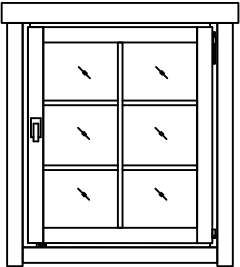
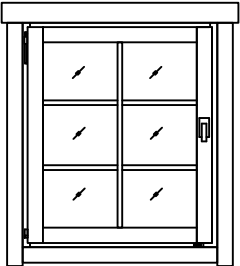
Pos	Kasai A 70, Art.No.7010141 Piece list - Stückliste - Liste des pieces		Q.	P (mm)	L (mm)
HS49	SCREW FOR POST HEIGHT ADJUSTMENT - SCHRAUBEN FÜR REGULIERUNGSSCHRAUBE FÜR PFOSTEN - VIS DE FIXATION DE SUPPORT RÉGLABLE DE POTEAU		16	6x50	
MS	SCREW FOR DOORSTEP - SCHRAUBEN FÜR TÜRSCHWELLE - VIS DE FIXATION DU SEUIL DE PORTE		8	4.5x65	
SH58	HAMMER BLOCK - SCHLAGHOLZ - CALLE DE FRAPPE		2		
NFD	ZN NAIL FOR ROOFING FELT FILLET - ZN NÄGEL FÜR DACHPAPPEN-LEISTE - POINTE POUR BAGUETTE FIXATION FEUTRE BITUMEUX		32	2x40	
NF3	ZN NAIL FOR TERRACE - ZN NÄGEL FÜR TERRASSENBRETT - POINTE POUR PLANCHER DE TERRASSE		250	2x50	
NFF	ZN NAIL FOR FILLETS - ZN NÄGEL FÜR LEISTEN - POINTE POUR CORNIERE		96	1.4x40	
NF2	ZN NAIL FOR ROOF - ZN NÄGEL FÜR DACHBRETT - POINTE POUR TOIT		960	2x50	
NH1	ZN NAIL FOR FLOOR - ZN NÄGEL FÜR FUSSBODENBRETT - CLOUS POUR PLANCHER		795	2x50	
GS	GABLE SEGMENT-DECKBLATT - LOSANGE DE FINITION		2		
SP2	HIDDEN FIXING - HOLZDÜBEL - TOURILLON BOIS		1		
SP1	HIDDEN FIXING - HOLZDÜBEL - TOURILLON BOIS		12		
RFP	POST HEIGHT ADJUSTMENT - REGULIERUNGSSCHRAUBE FÜR PFOSTEN - SUPPORT RÉGLABLE DE POTEAU		2		
ORZ	MONTAGE SET FOR DOORS AND WINDOWS - MONTAGE-SET FÜR TÜREN UND FENSTER - JEU DE MONTAGE PORTES ET FENETRES		1		
2+ A.6P.a	WINDOW-FENSTER-FENETRE 916x1050 		4		
2+ A.6V.a	WINDOW-FENSTER-FENETRE 916x1050 		1		

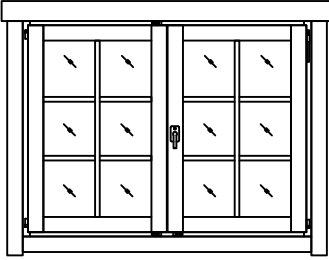
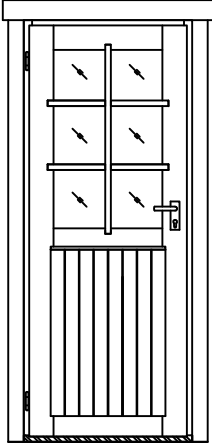
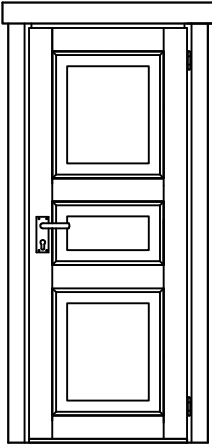
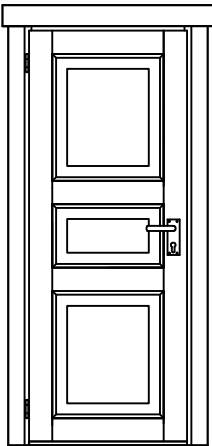
Pos	Kasai A 70, Art.No.7010141 Piece list - Stückliste - Liste des pieces	Q.	P (mm)	L (mm)
2+ TA .6P.a	WINDOW-FENSTER-FENETRE 1374x1050 	1		
2+ U. 26V.b	DOOR-TÜR-PORTE 827x2000 	1		
U.3TP.b	DOOR-TÜR-PORTE 827x2000 	1		
U.3TV.b	DOOR-TÜR-PORTE 827x2000 	2		

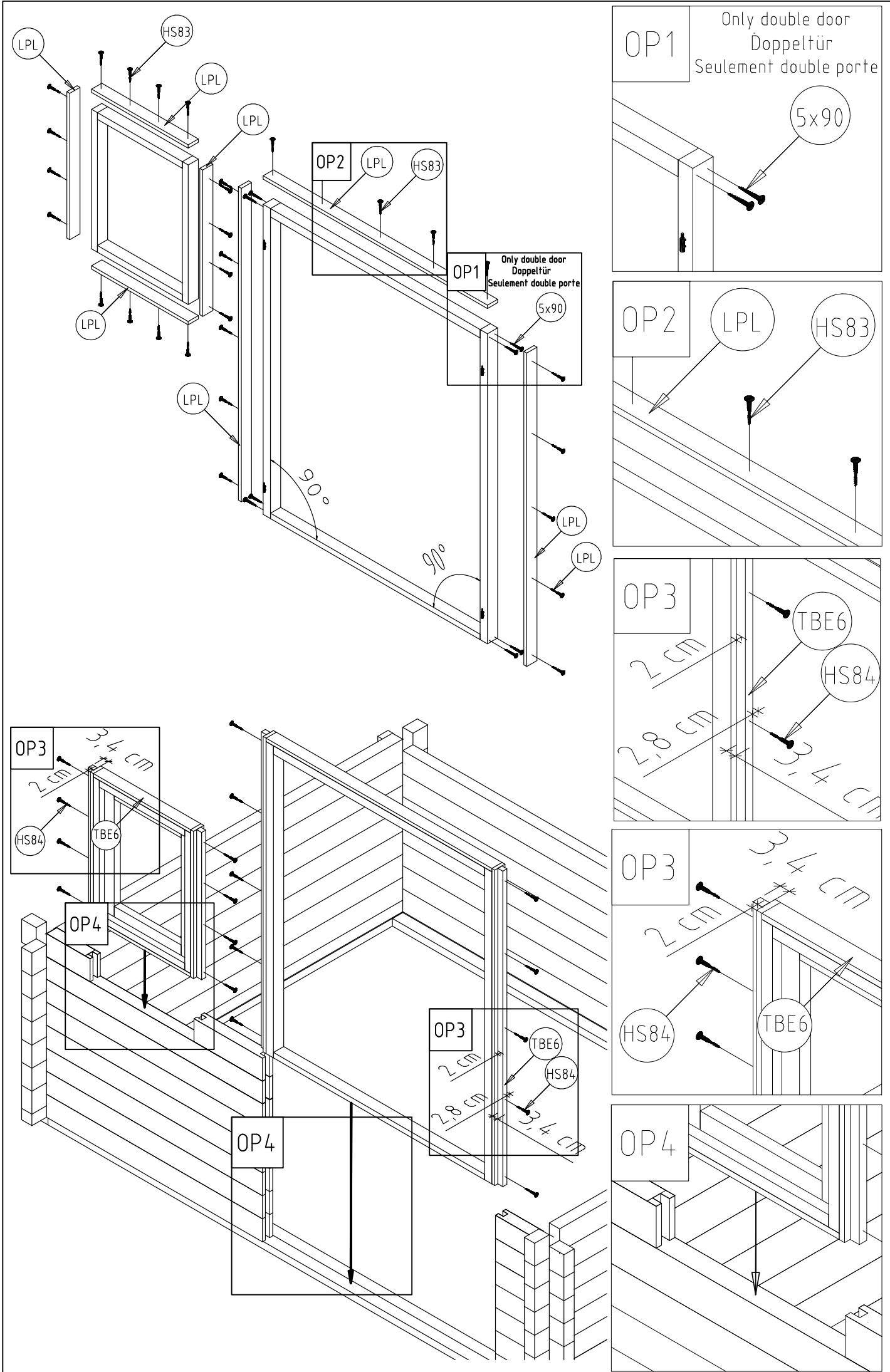

OP1 Only double door
Doppeltür
Seulement double porte

