

# ESSENTIAL LINE

ELEMENT CABINS · LOG CABINS  
GARAGES · ACCESSORIES



ASSORTMENT 2018



[www.lasita.com](http://www.lasita.com)

# TABLE OF CONTENTS

04 Element cabins

07 Log cabins

27 Garages & Accessories

## ABOUT US



















We are pleased to present our 2018 collection of our essential models. For approximately 20 years, we have had the pleasure of offering you a selection of garden buildings and cabins for your holidays.

We constantly pay attention to changing market needs and expectations so that we can bring you an increasing choice of cabins to suit the purpose you need them for. Each request is unique and requires its own original solution. Lasita Maja is seeking to develop cabins that suit your outside space and life.

You can use your new space for taking it easy while the kids play, or simply as an extra living area added onto your home. To satisfy you, the customer, we have set up a total quality control including production, delivery and customer service. Discover the compact essential range of Lasita Maja. We provide a solution for all your needs - varying from sheds up to leisure cabins and garages.

Thank you for choosing one of our garden buildings and we wish you many years of pleasure from your Lasita Maja log cabin!

## DESCRIPTION OF SYMBOLS

	Article number		Ridge height cm		Floor m <sup>2</sup>
	Wall thickness mm		Front overhang cm		Roofing felt
	Foundation dimensions cm		Roof canopy cm		Roofing shingles
	Area m <sup>2</sup>		Roof area m <sup>2</sup>		Terrace cm
	Volume m <sup>3</sup>		Door size cm		Storage unit
	Side wall height cm		Window size cm		
	produced in Estonia		produced in Hungary	✓	Included
				-	Not included
				⊙	Optional

# OUR QUALITY DETAILS



Our wall **log angle profile** are made with wind-tight connection, to ensure a better wind resistance.

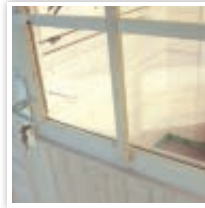

**High quality windows and doors** with real or plexi glazing.



**Impregnated foundation** beams to preserve your cabin from rises of humidity and give it longer life (available only in optional floor packages).



**Doors with cylinder lock** for security of your valuable garden tool.

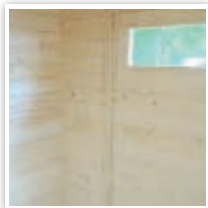

**Wooden storm protection** slats to protect your house from strong winds. (in some kits not included)

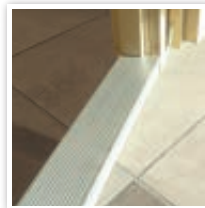

**Entry doors with low sill** (selected models with Aluminium cover), to provide easier access to store your heavy garden tools and machines in your log cabin.

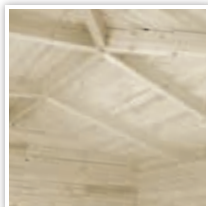

**15 mm or 18 mm** solid wood roof boards with tongue and groove joints.



Our houses are **packed carefully**. UV protection folio preserves them from bad weather conditions, also with a stable pallet which is fastened with belts to mitigate transport damages.

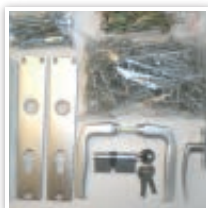

**Fixings and assembly instruction** come with every building - no additional hardware required.



**Delivery to your yard** will be easily handled by our experienced dealers and logistic partners.



[www.lasita.com](http://www.lasita.com)



**Unlimited choices** for your garden



BASIC



Sectional walls for easy assembly

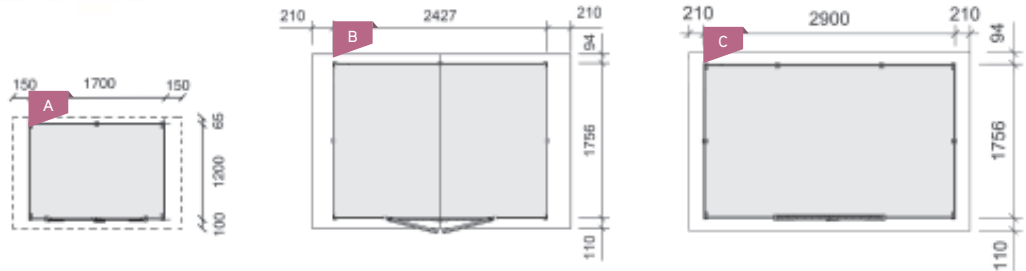

Product highlights

- from untreated Nordic Spruce
- sectional walls
- wide double door
- assembly kit included
- 15 mm solid roof boards
- roofing felt and floor included



	Nº	№	Material	Area (m²)	Volume (m³)	Roof Pitch	Roof Boards	Roof Felt	Floor	Windows	Doors	Assembly Kit	Roofing Felt	Floor
A	TYGO	59651600	13,5	170 x 120	2,04	3,95	182	218	10	2,88	120 x 175	✓	✓	⊙ 2
B	MILAN	59651642	13,5	243 x 176	4,3	8,7	182	220	11	5,88	120 x 175	✓	✓	⊙ 3
C	SVEN	59651645	13,5	290 x 176	5,1	10,3	182	220	11	6,7	120 x 175	✓	✓	⊙ 3

WIEN

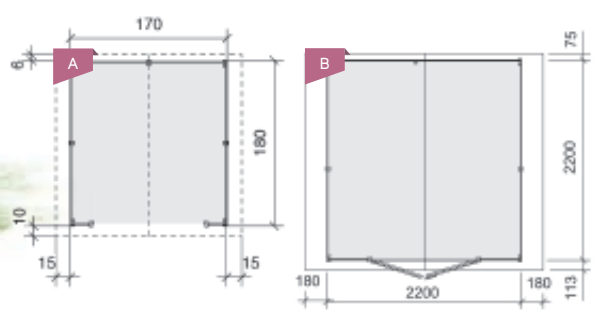

Product highlights

- from untreated Nordic Spruce
- sectional walls
- wide double door
- assembly kit included
- 15 mm solid roof boards
- floor included
- roofing felt for additional costs



	Nº	№	Material	Area (m²)	Volume (m³)	Roof Pitch	Roof Boards	Roof Felt	Floor	Windows	Doors	Assembly Kit	Roofing Felt	Floor
A	WIEN 1	59651620	14	170 x 180	2,8	5,5	184	218	10	120 x 170	✓	⊙ 2 x 10	⊙ 2	
B	WIEN 2	59651690	14	220 x 220	5,08	9,86	184	218	11	120 x 175	✓	⊙ 2 x 10	⊙ 3	



# JULIAN



## Product highlights

- from untreated Nordic Spruce
- sectional walls
- wide double door
- assembly kit included
- 15 mm solid roof boards
- roofing felt and floor included

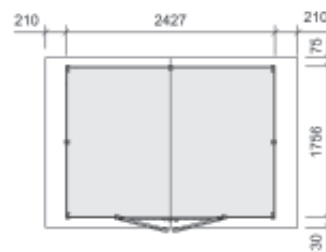

JULIAN

59651643

14

243 x 176

4,22

8,32

182

212

13

5,53

120 x 175

✓

✓

# GRAZ



## Product highlights

- from untreated Nordic Spruce
- sectional walls
- wide double door
- assembly kit included
- with side roof width 150 cm
- 15 mm solid roof boards
- floor included
- roofing felt for additional costs

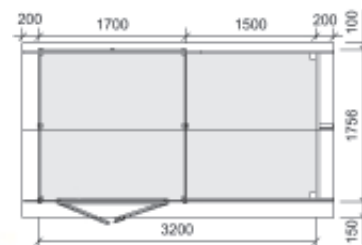

GRAZ

59651647

13,5

320/176 x 176

5,5

10,9

182

212

15

120 x 175

✓

⊙ 1 x 10

**VERA** 

**Product highlights**

- from untreated Nordic Spruce
- sectional walls
- wide double door
- assembly kit included
- 15 mm solid roof boards
- optional roof extension
- roofing felt and floor included

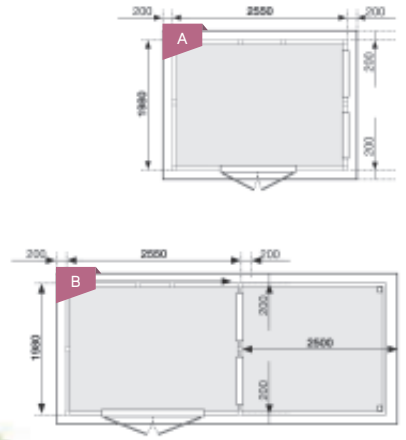

A	VERA	456792	19	255 x 198	5,1	9,8	188	205	20	-	139 x 175	93 x 43	✓	✓
B	VERA + ROOF EXTENSION	456785	19	505 x 198	10,1	19,6	188	205	20	258 x 198	139 x 175	93 x 43	✓	✓

**VIOLET** 

**Product highlights**

- from untreated Nordic Spruce
- sectional walls
- wide double door
- assembly kit included
- 15 mm solid roof boards
- optional roof extension
- roofing felt and floor included

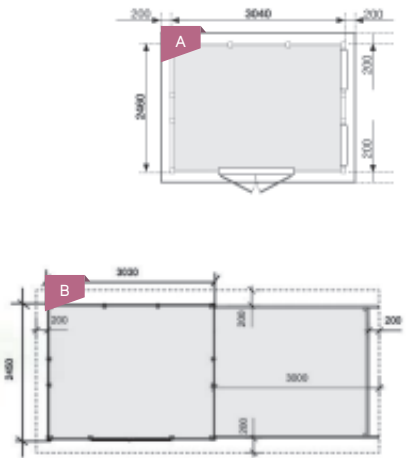

A	VIOLET	4568080	19	304 x 246	7,5	16	188	205	20	-	139 x 175	93 x 43	✓	✓
B	VIOLET + ROOF EXTENSION	456822	19	603 x 246	14,7	32	188	205	20	300 x 246	139 x 175	93 x 43	✓	✓

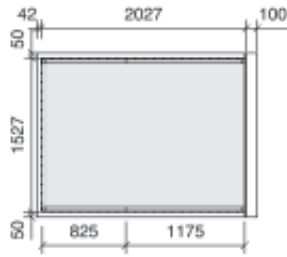

Product highlights

- from untreated Nordic Spruce
- sectional walls
- with a steel roof
- assembly kit included
- for up to 3 bikes

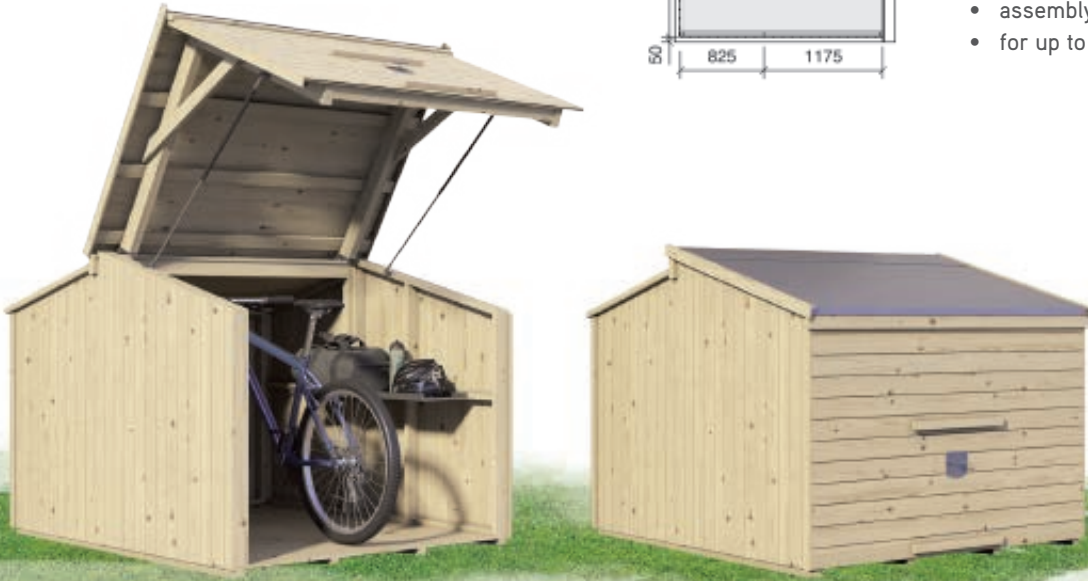

BIKEBOX	460045	14	150 x 200	3,1	3,5	106 / 111	135	150 x 117	✓
---------	--------	----	-----------	-----	-----	-----------	-----	-----------	---



Product highlights

- from untreated Nordic Spruce
- wall thickness 18 mm
- large single door
- assembly kit included
- 15 mm solid roof boards
- roofing felt included
- optional floor for additional costs

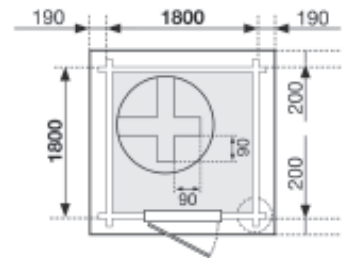

NICK	103900	18	180 x 180	3,2	6,37	175	218	20	6,5	86 x 166	⊙ 1 x 3.0 / 1 x 1.5	✓	⊙ 3
------	--------	----	-----------	-----	------	-----	-----	----	-----	----------	---------------------	---	-----



# FRODO 1

LOG CABINS



## Product highlights

- from untreated Nordic Spruce
- wall thickness 18 mm
- wide double door
- assembly kit included
- 15 mm solid roof boards
- roofing felt included
- optional floor for additional costs

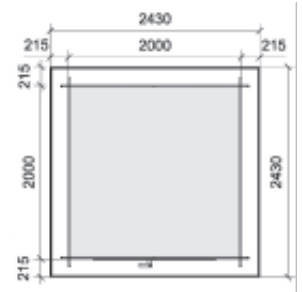

FRODO 1	59104310	18	200 x 200	4	8,08	193	210	21	6,6	128 x 170	⊙ 1 x 3.0 / 1 x 1.5	✓
---------	----------	----	-----------	---	------	-----	-----	----	-----	-----------	---------------------	---

# FRODO 2

Roof extension  
can be installed  
to the left or  
right side



## Product highlights

- from untreated Nordic Spruce
- wall thickness 18 mm
- wide double door
- assembly kit included
- 15 mm solid roof boards
- roofing felt included
- optional floor for additional costs

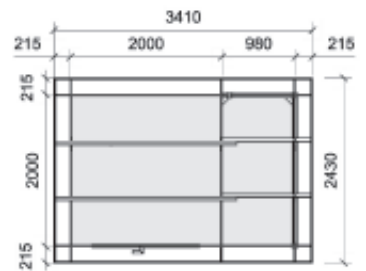

optional  
mirroring



FRODO 2	59104315	18	298/200 x 200	5,96	12,12	193	210	98 x 200	21	9,2	128 x 170	⊙ 1 x 3.0 / 1 x 1.5	✓
---------	----------	----	---------------	------	-------	-----	-----	----------	----	-----	-----------	---------------------	---



## Product highlights

- from untreated Nordic Spruce
- wall thickness 18 mm
- wide double door
- assembly kit included
- 15 mm solid roof boards
- floor and roofing felt included

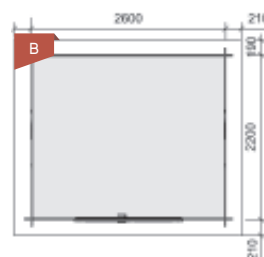
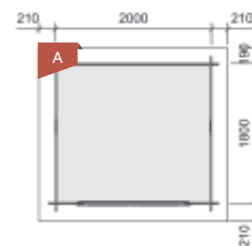

		Nº	mm	m <sup>2</sup>	m <sup>3</sup>	mm	mm	mm	mm	mm	m <sup>2</sup>	mm		
A	SALZBURG 1	59197680	18	200 x 180	3,6	7,11	190	205	21	5,42	128 x 170	✓	✓	
B	SALZBURG 2	59197690	18	260 x 220	5,72	11,3	190	205	21	6,83	128 x 170	✓	✓	



## Product highlights

- from untreated Nordic Spruce
- wall thickness 18 mm
- wide double door
- assembly kit included
- 15 mm solid roof boards
- roofing felt included
- optional floor for additional costs

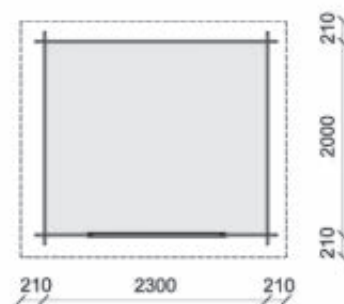

		Nº	mm	m <sup>2</sup>	m <sup>3</sup>	mm	mm	mm	mm	mm	m <sup>2</sup>	mm	
JORN	591058661	18	230 x 200	4,6	9,45	198	214	21	7,17	128 x 170	⊙ 2 x 3.0	✓	









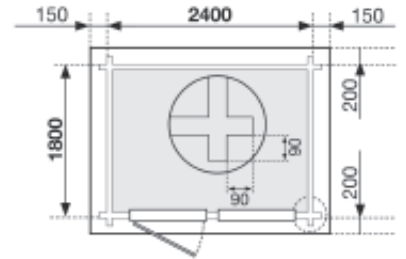





with a solid door



**Product highlights**

- from untreated Nordic Spruce
- wall thickness 18 mm
- assembly kit included
- 15 mm solid roof boards
- roofing felt included
- optional floor for additional costs
- with a solid door



														
GREGOR	105409	18	240 x 180	4,3	9,27	194	234	21	8,7	79 x 175	93 x 70	⊙ 1 x 3.0 / 1 x 1.5	✓	⊙ 4

With two double doors  
Roof extension can be installed to the left or right side







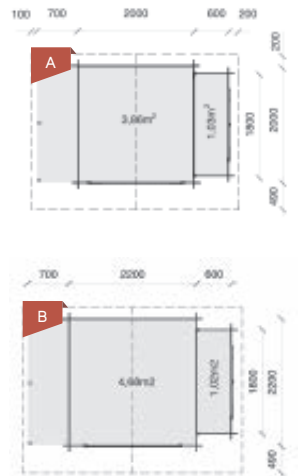







**Product highlights**

- from untreated Nordic Spruce
- wall thickness 18 mm or 28 mm
- wide double door
- assembly kit included
- 15 mm solid roof boards
- roofing felt and floor included



optional mirroring

														
A	VILANO 1	59103500	18	330 x 200	4,89	8,1	163/188	223	49	11,71	125 x 165   116 x 144	✓	✓	⊙ 4
B	VILANO 2	3522822281	28	350 x 220	5,7	9,2	184	225	49	12,8	125 x 165   116 x 144	✓	✓	⊙ 4





## Product highlights

- from untreated Nordic Spruce
- wall thickness 18 mm
- wide double door
- assembly kit included
- 15 mm solid roof boards
- roofing felt and floor included



Colour for illustration only

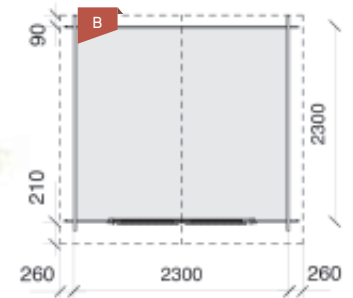
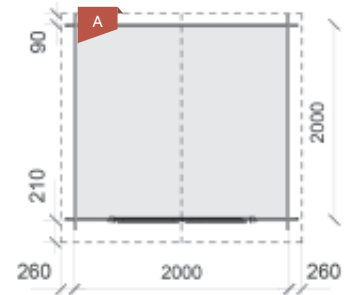

	No	Wall thickness	Floor area	Volume	Length	Width	Roof area	Roof area	Door type	Assembly kit	Roofing felt	Floor		
A	HELSINKI 3	591058630	18	200 x 200	4	8,3	184	225	21	6,96	128 x 170	✓	✓	⊙ 3
B	HELSINKI 4	591058620	18	230 x 230	5,29	10,9	184	225	21	8,53	128 x 170	✓	✓	⊙ 4



## Product highlights

- from untreated Nordic Spruce
- wall thickness 18 mm
- wide double door
- assembly kit included
- 15 mm solid roof boards
- floor and roofing felt included

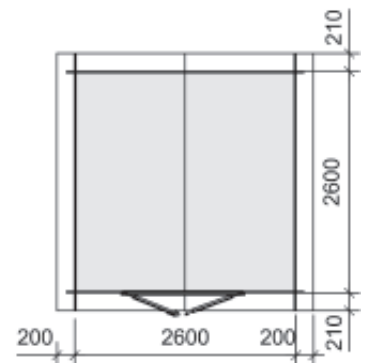

	No	Wall thickness	Floor area	Volume	Length	Width	Roof area	Roof area	Door type	Assembly kit	Roofing felt	Floor	
LINZ 1	59197670	18	260 x 260	6,76	13,88	185	226	21	9,33	128 x 170	✓	✓	⊙ 4

# LINZ 2



LOG CABINS



## Product highlights

- from untreated Nordic Spruce
- wall thickness 18 mm
- Single door and fixed single window
- assembly kit included
- 15 mm solid roof boards
- floor and roofing felt included

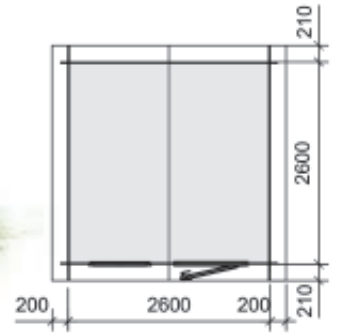

optional mirroring

Nº	59197675	18	260 x 260	6,76	13,88	185	226	21	9,33	80 x 170	✓	✓	6
----	----------	----	-----------	------	-------	-----	-----	----	------	----------	---	---	---

# NINA



## Product highlights

- from untreated Nordic Spruce
- wall thickness 28 mm
- large single door and window
- assembly kit included
- 15 mm solid roof boards
- roofing felt included
- optional floor for additional costs

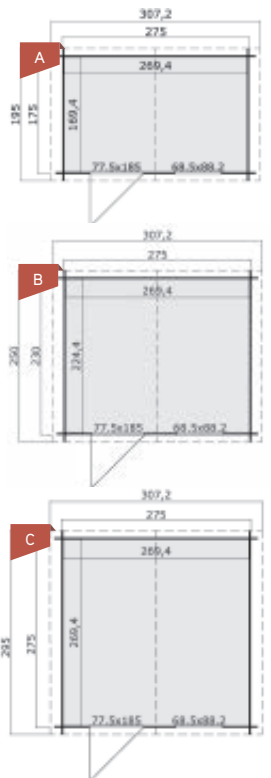

Nº	2834450	28	275 x 175	4,56	9,75	194	234	10	6,24	77 x 185	68 x 88	2 x 3.0	✓	3	
A	NINA 175	2834450	28	275 x 175	4,56	9,75	194	234	10	6,24	77 x 185	68 x 88	2 x 3.0	✓	3
B	NINA 230	2834550	28	275 x 230	6,05	12,92	194	234	10	8	77 x 185	68 x 88	2 x 3.0 / 1 x 1.5	✓	4
C	NINA 275	2834650	28	275 x 275	7,26	15,51	194	234	10	9,44	77 x 185	68 x 88	2 x 3.0 / 1 x 1.5	✓	4

# MORAVA B



## Product highlights

- from untreated Nordic Spruce
- wall thickness 28 mm
- double door
- front overhang 16 cm
- assembly kit included
- 15 mm solid roof boards
- roofing felt included
- optional floor for additional costs

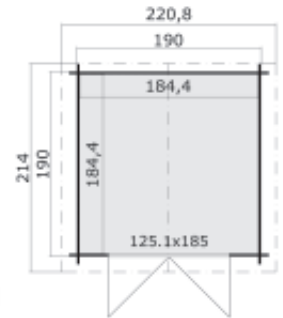

MORAVA B

2810650

28

190 x 190

3,4

6,88

182

222

16

5,14

125 x 185

● 1 x 3.0 / 1 x 1.5

✓

● 3

# MORAVA A



## Product highlights

- from untreated Nordic Spruce
- wall thickness 28 mm
- wide double door
- front overhang 16 cm
- assembly kit included
- 15 mm solid roof boards
- roofing felt included
- optional floor for additional costs

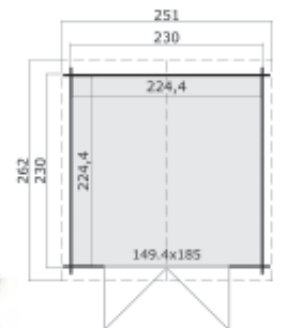

MORAVA A

2810550

28

230 x 230

5,04

10,19

182

222

16

6,97

149 x 185

● 2 x 3.0

✓

● 3



# WELS 1 / 2 / 3



LOG CABINS

## Product highlights

- from untreated Nordic Spruce
- wall thickness 28 mm
- single door
- single window
- assembly kit included
- 15 mm solid roof boards
- floor included

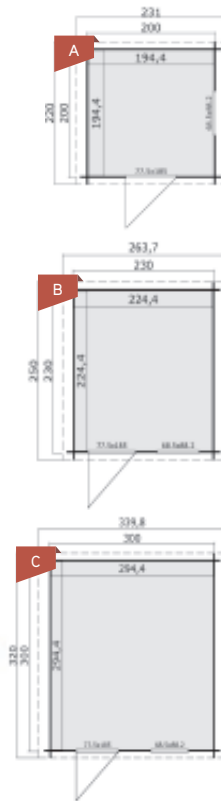

	Nº	28	200 x 200	3,78	8,29	194	234	10	5,5	77 x 185	68 x 88	✓	⊙ 3	⊙ 1 x 10	
A	WELS 1	2837400	28	200 x 200	3,78	8,29	194	234	10	5,5	77 x 185	68 x 88	✓	⊙ 3	⊙ 1 x 10
B	WELS 2	2837500	28	230 x 230	5,04	11,05	194	234	10	7	77 x 185	68 x 88	✓	⊙ 3	⊙ 1 x 15
C	WELS 3	2837600	28	300 x 300	8,67	19,02	194	245	10	11,81	77 x 185	68 x 88	✓	⊙ 5	⊙ 2 x 10

# WELS 4 / 5



## Product highlights

- from untreated Nordic Spruce
- wall thickness 28 mm
- single or double door
- 2 x single window
- assembly kit included
- 15 mm solid roof boards
- floor included

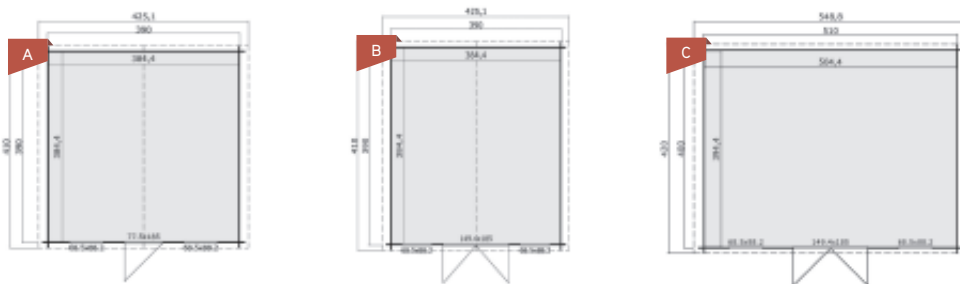

	Nº	28	390 x 390	14,78	32,43	194	245	10	18,04	77 x 185	68 x 88	✓	⊙ 7	⊙ 2 x 15	
A	WELS 4 ET	2830500	28	390 x 390	14,78	32,43	194	245	10	18,04	77 x 185	68 x 88	✓	⊙ 7	⊙ 2 x 15
B	WELS 4 DT	2830400	28	390 x 390	14,78	32,43	194	245	10	18,04	149 x 185	68 x 88	✓	⊙ 7	⊙ 2 x 15
C	WELS 5	2837700	28	510 x 400	19,89	43,66	194	245	10	23,52	149 x 185	68 x 88	✓	⊙ 9	⊙ 4 x 10

# LOS ANGELES, CHICAGO, BALTIMORE, HOUSTON

## Product highlights

- from untreated Nordic Spruce
- wall thickness 28 mm
- wide double door

- front overhang 50 cm (Baltimore)
- assembly kit included
- 15 mm solid roof boards
- roofing felt included
- optional floor for additional costs

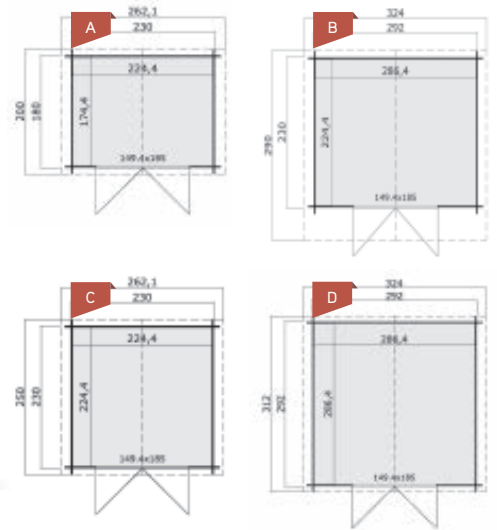

	Nº	Icon	Icon	Icon	Icon	Icon	Icon	Icon	Icon	Icon	Icon	Icon	Icon	Icon	Icon
A	LOS ANGELES	2825750	28	230 x 180	3,91	8,14	194	222	10	5,4	149 x 185	⊙ 1 x 3.0 / 1 x 1.5	✓	⊙ 3	
B	CHICAGO	2825650	28	230 x 230	5,04	10,48	194	222	10	6,75	149 x 185	⊙ 2 x 3.0	✓	⊙ 3	
C	BALTIMORE	2825150	28	292 x 230	6,43	13,37	194	222	50	9,57	149 x 185	⊙ 2 x 3.0 / 1 x 1.5	✓	⊙ 3	
D	HOUSTON	2822950	28	292 x 292	8,2	17,07	194	222	10	10,3	149 x 185	⊙ 3 x 3.0	✓	⊙ 5	

# DALLAS

## Product highlights

- from untreated Nordic Spruce
- wall thickness 28 mm
- wide double door

- assembly kit included
- 15 mm solid roof boards
- roofing felt included
- optional floor for additional costs

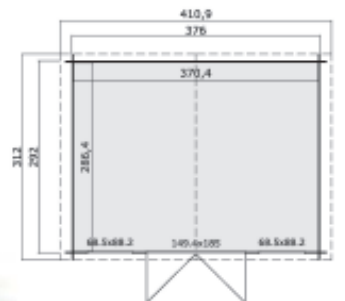

DALLAS	2825350	28	376 x 292	10,61	22,63	194	234	10	13,1	149 x 185	68 x 88	⊙ 4 x 3.0	✓	⊙ 6
--------	---------	----	-----------	-------	-------	-----	-----	----	------	-----------	---------	-----------	---	-----



Product highlights

- from untreated Nordic Spruce
- wall thickness 28 mm
- wide double door

- with top-hung window
- assembly kit included
- 15 mm solid roof boards
- roofing felt included
- optional floor for additional costs

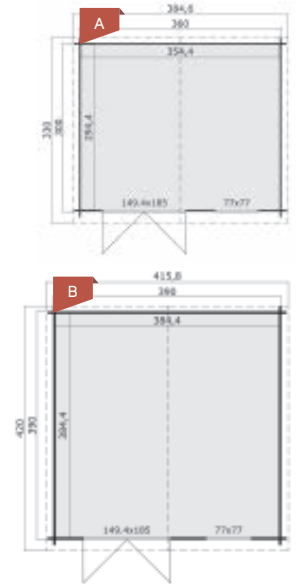

	Nº	Wall thickness	Area (m²)	Volume (m³)	Roof type	Roof area (m²)	Door	Window	Accessories	Optional floor	Optional roof				
A	EBRO B	2810250	28	360 x 300	10,4	22,9	194	245	20	13,2	149 x 185	77 x 77	3 x 3.0 / 1 x 1.5	✓	6
B	EBRO C	2814050	28	390 x 390	14,8	32,43	194	245	20	18,06	149 x 185	77 x 77	5 x 3.0	✓	7

BOSTON, WASHINGTON



Product highlights

- from untreated Nordic Spruce
- wall thickness 28 mm
- wide double door

- with top-hung window
- assembly kit included
- 15 mm solid roof boards
- roofing felt included
- optional floor for additional costs

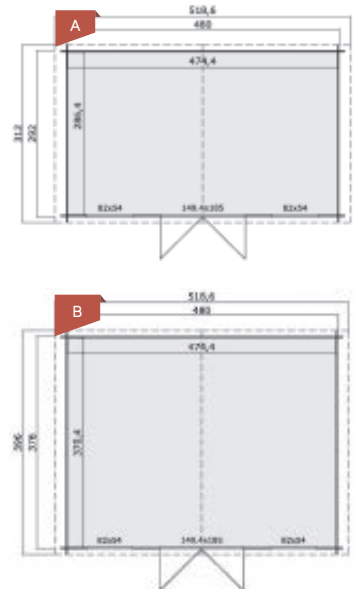

with two top-hung windows



	Nº	Wall thickness	Area (m²)	Volume (m³)	Roof type	Roof area (m²)	Door	Window	Accessories	Optional floor	Optional roof				
A	BOSTON	2825450	28	480 x 292	13,59	29,82	194	245	10	16,54	149 x 185	82 x 54	5 x 3.0	✓	7
B	WASHINGTON	2825550	28	480 x 376	17,57	38,56	194	245	10	20,99	149 x 185	82 x 54	6 x 3.0	✓	8



# ROBIN 280



## Product highlights

- from untreated Nordic Spruce
- wall thickness 28 mm
- wide fully glazed double door
- assembly kit included
- 15 mm solid roof boards
- roofing felt and floor included
- plexi-glazed

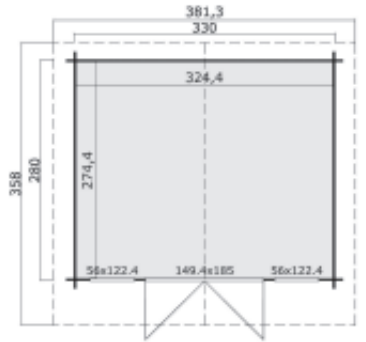

ROBIN 280

2840901

28

330 x 280

8,9

19,53

194

245

55

14,2

149 x 185

56 x 122

✓

✓

6

# MONTANA



## Product highlights

- from untreated Nordic Spruce
- wall thickness 34 mm
- extra wide double door
- assembly kit included
- 15 mm solid roof boards
- roofing felt and floor included
- plexi-glazed

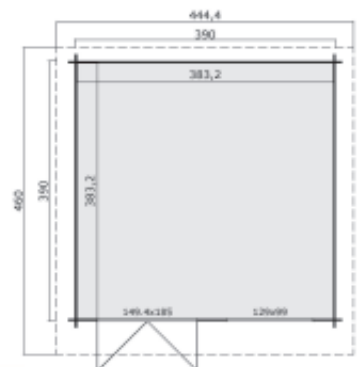

MONTANA

3414301

34

390 x 390

14,68

35,57

217

268

50

21,16

149 x 185

129 x 99

✓

✓

9

# WILLIAM



## Product highlights

- from untreated Nordic Spruce
- wall thickness 28 mm
- extra wide double door and solid single door
- 2 vertical skylights
- assembly kit included
- 15 mm solid roof boards
- roofing felt and floor included
- separate storage room

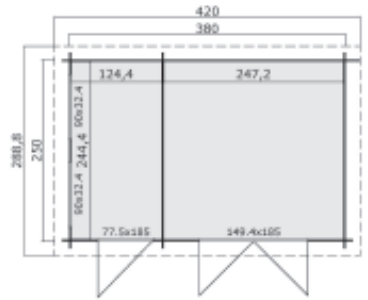

WILLIAM	2841701	28	380 x 250	9,15	20,08	200	239	22	13,02	149 x 185   77 x 185	90 x 32	✓	✓	6
---------	---------	----	-----------	------	-------	-----	-----	----	-------	----------------------	---------	---	---	---

# IVANA



## Product highlights

- from untreated Nordic Spruce
- wall thickness 28 mm
- wide double door
- assembly kit included
- 15 mm solid roof boards
- roofing felt included
- optional floor for additional costs
- spacious roof extension

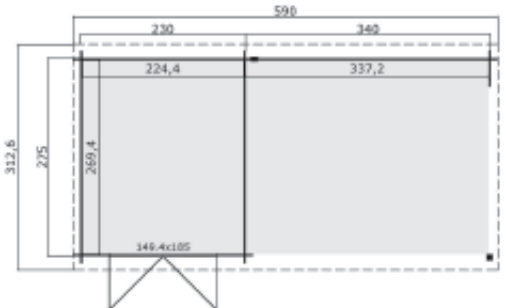

IVANA	2838550	28	570/230 x 275	15,2	32,5	200	228	3,4 x 2,75	19	18,88	149 x 185	3 x 3,0 / 1 x 1,5	✓	8
-------	---------	----	---------------	------	------	-----	-----	------------	----	-------	-----------	-------------------	---	---



## Product highlights

- from untreated Nordic Spruce
- wall thickness 28 mm
- garden house with 2 rooms
- extra wide double door

- additional service door
- provides plenty of natural light
- assembly kit included
- 15 mm solid roof boards
- roofing felt included
- optional floor for additional costs

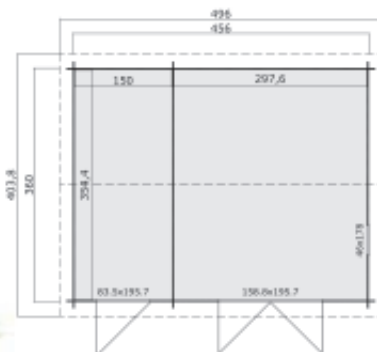

Nº



CARROZ

2813550

28

456 x 360

15,96

37,76

210

262

22

20,83

159 x 196 | 83 x 196

46 x 178

⊙ 5 x 3.0 / 1 x 1.5

✓

⊙ 8



## Product highlights

- from untreated Nordic Spruce
- wall thickness 28 mm
- extra wide double door and additional service door

- garden house with 2 rooms
- assembly kit included
- 18 mm solid roof boards
- roofing felt for additional costs
- floor included

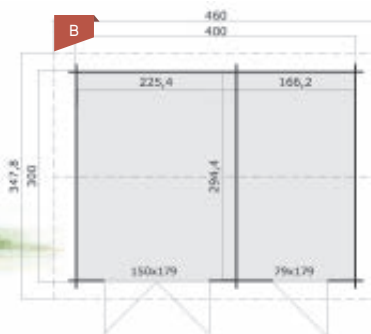
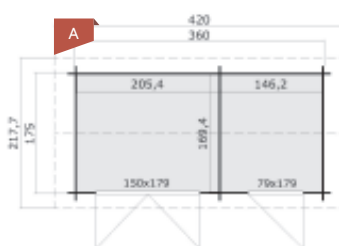

Nº



A TUVALU 1

285100

28

360 x 175

6

13,9

211

251

21

10,1

150 x 179 | 79 x 179

✓

⊙ 1

⊙ 5

B TUVALU 2

282300

28

400 x 300

11,6

26,8

211

251

24

16,6

150 x 179 | 79 x 179

✓

⊙ 2

⊙ 7





### Product highlights

- from untreated Nordic Spruce
- wall thickness 28 mm
- assembly kit included
- 15 mm solid roof boards
- roofing felt included
- optional floor for additional costs

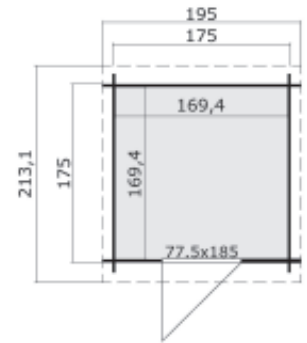

JELLE

2839050

28

175 x 175

2,87

5,72

188

211

20

4,19

77 x 185

1 x 3.0

✓



### Product highlights

- from untreated Nordic Spruce
- wall thickness 28 mm
- wide double door
- assembly kit included
- 15 mm solid roof boards
- roofing felt included
- optional floor for additional costs

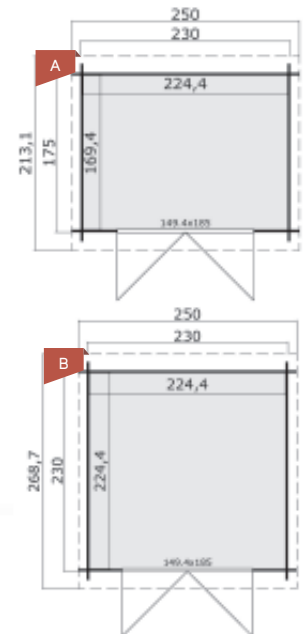

A INDI 175

2834050

28

230 x 175

3,8

7,58

188

211

20

4,19

149 x 185

1 x 3.0 / 1 x 1.5

✓

B INDI 230

2834150

28

230 x 230

5,04

10,05

188

211

20

6,75

149 x 185

2 x 3.0

✓





### Product highlights

- from untreated Nordic Spruce
- wall thickness 28 mm
- extra wide double door

- single window
- assembly kit included
- 15 mm solid roof boards
- roofing felt included
- optional floor for additional costs

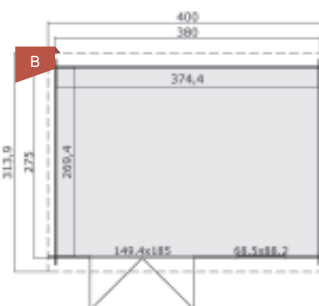
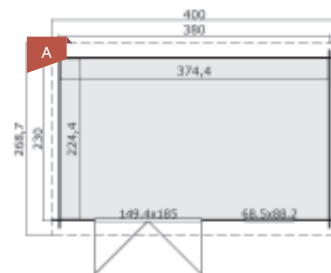

	No.	Code	Wall	Size	Floor	Volume	Height	Depth	Roof	Slope	Door	Window	Kit	Floor
A	AMIRA 230	2836850	28	380 x 230	8,4	16,76	188	211	19	10,8	149 x 185	68 x 88	⊙ 3 x 3.0	✓
B	AMIRA 275	2836950	28	380 x 275	10,09	20,12	188	211	19	12,6	149 x 185	68 x 88	⊙ 3 x 3.0 / 1 x 1.5	✓



### Product highlights

- from untreated Nordic Spruce
- wall thickness 28 mm or 34 mm
- fully glazed double and solid single door

- assembly kit included
- 15 mm solid roof boards
- roofing felt and floor included
- plexi-glazed

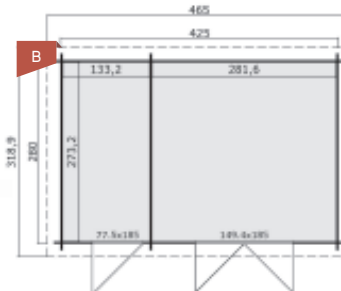
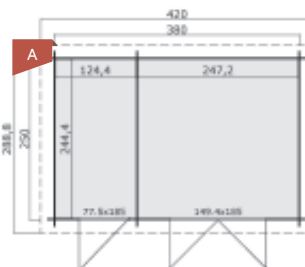

	No.	Code	Wall	Size	Floor	Volume	Height	Depth	Roof	Slope	Door	Window	Kit	Floor
A	BELMONT 1	2837801	28	380 x 250	9,15	19,3	200	222	28	12,81	149 x 185	77 x 185	✓	✓
B	BELMONT 2	3414201	34	425 x 280	11,43	24,1	200	222	28	14,88	149 x 185	77 x 185	✓	✓



# JELLE PLUS

## Product highlights

- from untreated Nordic Spruce
- wall thickness 28 mm
- assembly kit included
- 15 mm solid roof boards
- roofing felt included
- optional floor for additional costs
- spacious roof extension

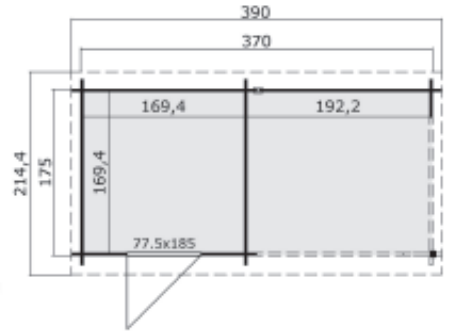

JELLE PLUS

2839150

28

370/175 x 175

6,17

12,32

188

211

20

8,38

77 x 185

⊙ 2 x 3.0 / 1 x 1.5

✓

# NOVIA PLUS

## Product highlights

- from untreated Nordic Spruce
- wall thickness 28 mm
- assembly kit included
- 15 mm solid roof boards
- roofing felt included
- optional floor for additional costs
- spacious roof extension

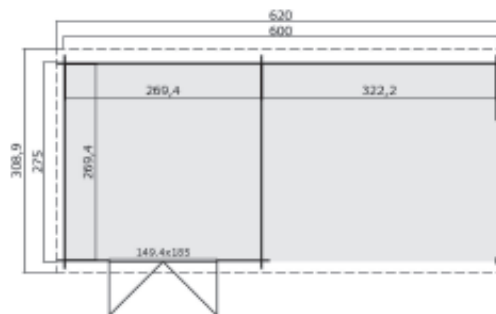

NOVIA PLUS

2839950

28

600/275 x 275

16,01

31,95

188

211

15

19,22

149 x 185

⊙ 3 x 3.0

✓

TAMPA

Product highlights

- from untreated Nordic Spruce
- wall thickness 28 mm
- wide double door
- assembly kit included
- 15 mm solid roof boards
- roofing felt included
- optional floor for additional costs
- spacious roof extension

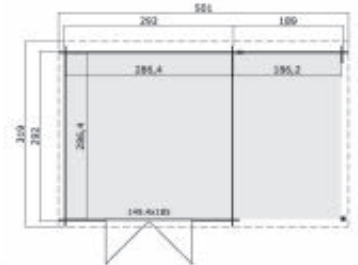

TAMPA	2825050	28	481/292 x 292	8,2	16,36	188	211	186	17	16,03	149 x 185	3 x 3.0	✓
-------	---------	----	---------------	-----	-------	-----	-----	-----	----	-------	-----------	---------	---

ST. LOUIS

Product highlights

- from untreated Nordic Spruce
- wall thickness 28 mm
- wide double door
- assembly kit included
- 15 mm solid roof boards
- roofing felt included
- optional floor for additional costs
- spacious roof extension

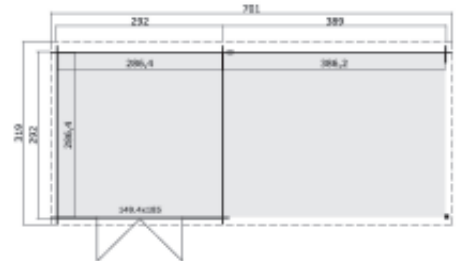

ST. LOUIS	2824650	28	681/292 x 292	8,2	16,36	188	211	386	17	22,43	149 x 185	3 x 3.0	✓
-----------	---------	----	---------------	-----	-------	-----	-----	-----	----	-------	-----------	---------	---

# KENZO

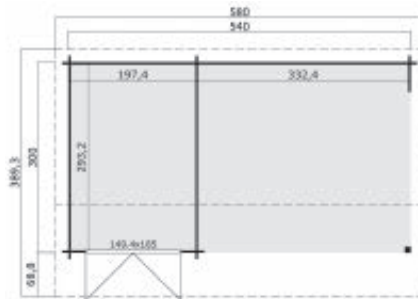

## Product highlights

- from untreated Nordic Spruce
- wall thickness 34 mm
- wide solid double door
- spacious roof extension
- assembly kit included
- 15 mm solid roof boards
- floor included
- roofing felt for additional costs



KENZO

3415500

34

540/197 x 300

15,63

40,55

245

274

70

23,78

149x185



3 x 15

10

# WIBO

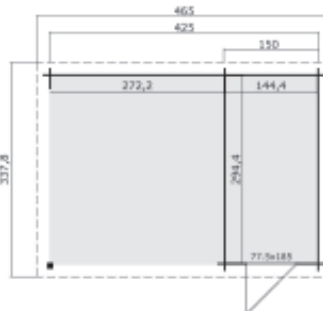

## Product highlights

- from untreated Nordic Spruce
- wall thickness 28 mm
- wide solid double door
- spacious roof extension
- assembly kit included
- 15 mm solid roof boards
- floor included
- roofing felt for additional costs
- plexi-glazed



WIBO

2833400

28

425/144 x 300

12,35

27,8

205

245

19

16,28

77 x 185



2 x 10

7





Product highlights

- from untreated Nordic Spruce
- wall thickness 28 mm
- wide solid double door
- spacious roof extension
- assembly kit included
- 15 mm solid roof boards
- floor included
- roofing felt for additional costs
- plexi-glazed

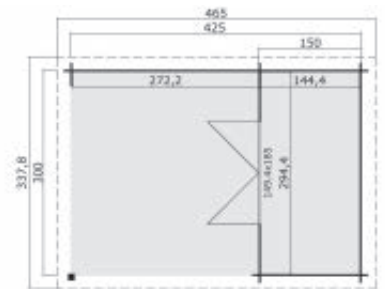

WALTER

2833500

28

425/150 x 300

12,35

27,8

205

245

20

16,28

77 x 185

✓

● 2 x 10

● 7

FLOORS

Optional floor

Extend your log cabin with our optional floor, available as 1.5 or 3 m2 packages. Floor package includes 18 mm thickness solid floorboards, impregnated foundation beams and hardware set.



A	FLOOR 1.5	2827900	1,5
B	FLOOR 3.0	2828000	3

## Product highlights

- from untreated Nordic Spruce
- wall thickness 28 mm
- wide solid double door
- assembly kit included
- 18 mm solid roof boards
- roofing felt included
- without floor

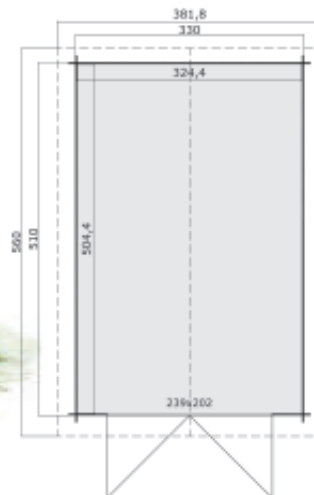

MAURITIUS	287450	28	330 x 510	16,4	38,71	211	262	30	22,40	239 x 202	✓	9
-----------	--------	----	-----------	------	-------	-----	-----	----	-------	-----------	---	---

## Product highlights

- from untreated Nordic Spruce
- wall thickness 34 mm (Dillon)
- wall thickness 40 mm (Yarik)
- wide solid double door
- assembly kit included
- 15 mm solid roof boards
- roofing felt included
- without floor
- plexi-glazed

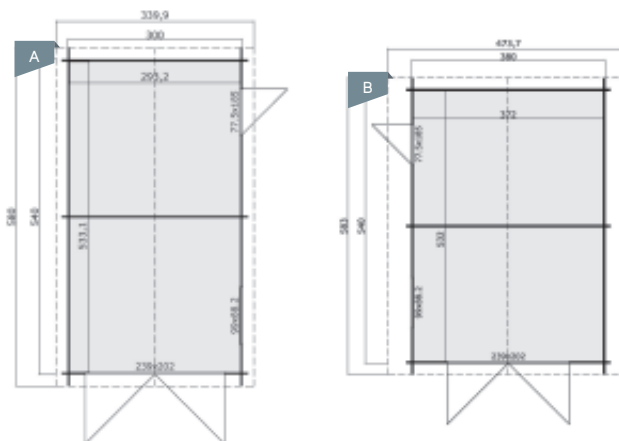

A	DILLON	3415450	34	300 x 540	15,63	37,87	211	274	20	21,46	239 x 202 / 77 x 185	99 x 88	✓	9
B	YARIK	4015850	40	380 x 540	19,79	47,94	211	274	20	29	239 x 202 / 77 x 185	99 x 88	✓	11





Visit us online  
**WWW.LASITA.COM**



Please scan this  
QR Code to get more  
information about us



Please scan this  
QR Code to watch  
our assembly video