

Töövahendid ja kirivöö rakendamise viisid

Töövahendid



Abivahendid ringse vöö kudumiseks; vahelikupulgad, vöönoad, niiepulka, piirits



Abivahendid tihvaga kudumiseks; tihv, süstik, otsalauad.

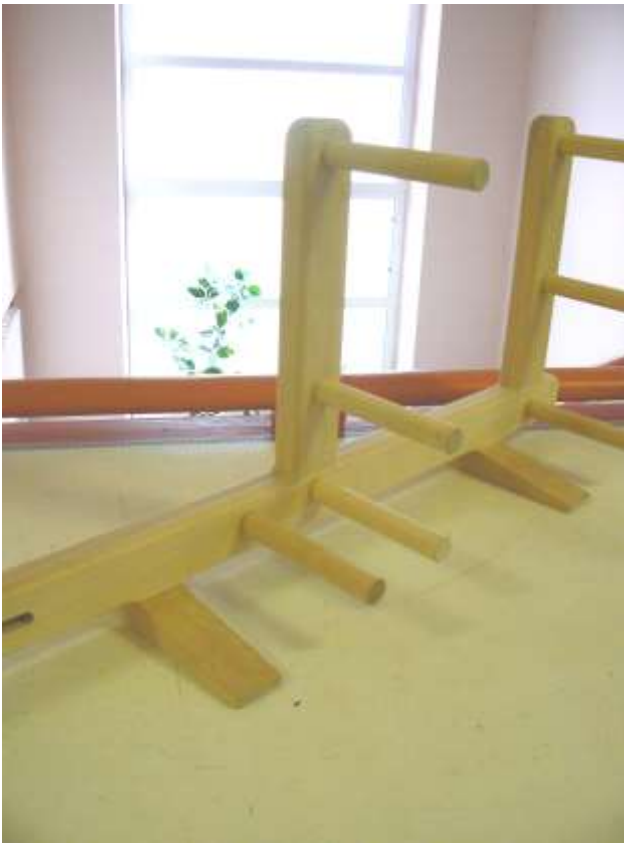

Vööraam



Karula Käsitööseltsi vöökudumise raam näitusel 2009 a Valga muuseumis.
Sama vöökudumise raami alumine ots.



Sama vöökudumise raami keskmine osa ning raam külgsaates.

Pulgale rakendamine ja kudumine

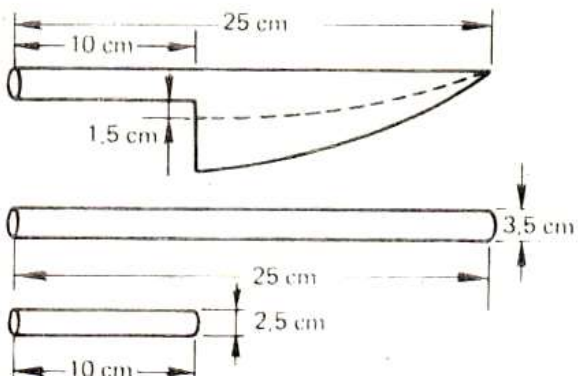

Vöömõõk, vahelikupulk ja niiepulk.

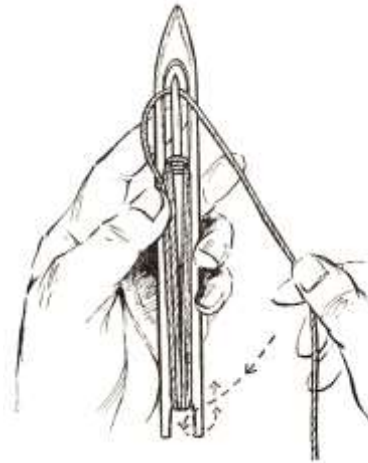

Piiritsale lõnga mässimine.

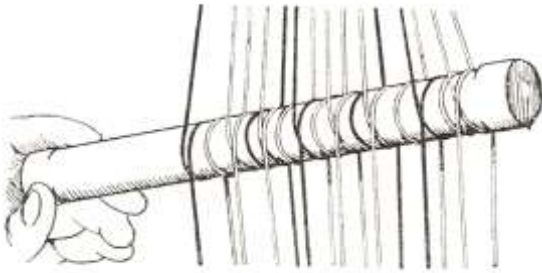

Kirivöö lõimelõngad vahelikupulgal.

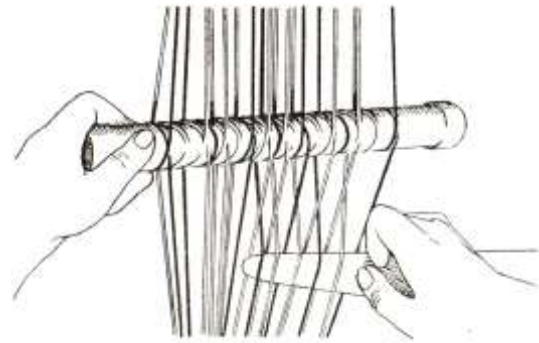

Alumise vaheliku lõngade mõõgale korjamine.

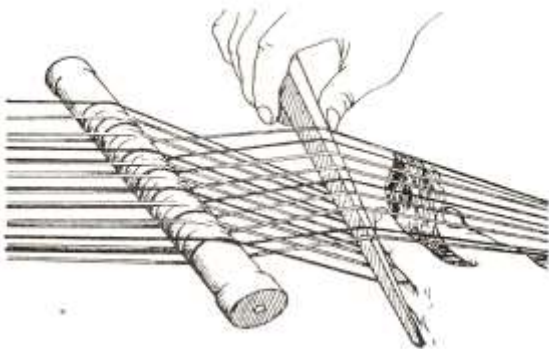

Niite tegemine I.

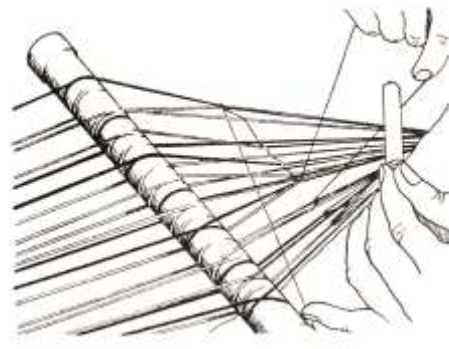

Niite tegemine II.

Belitser, V., Habicht, T., Moora, A., Moora, H., Rebane, M., Trees, L. (1957). *Eesti rahvarõivaid XIX sajandist ja XX sajandi algult*. Tallinn: Eesti Riiklik Kirjastus.



Vöökudumise raam ja piirits koelõngade jaoks Eesti Rahva Muuseumis.



Eesti naine on väga nutikas. <http://aveojaste.blogspot.com>

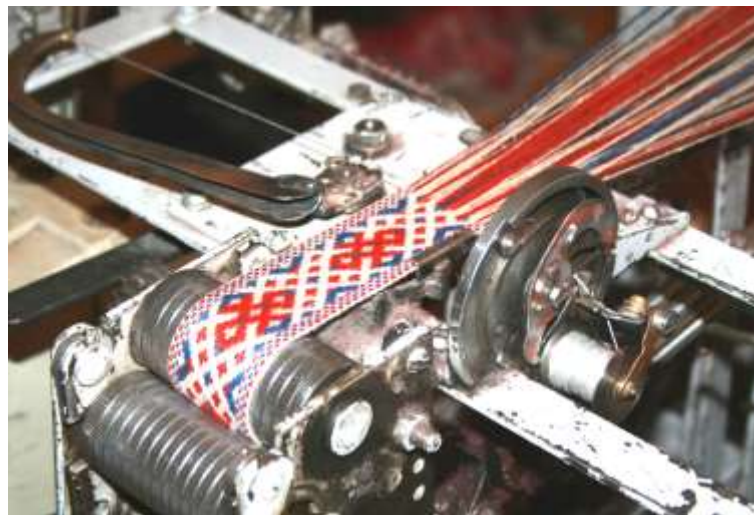
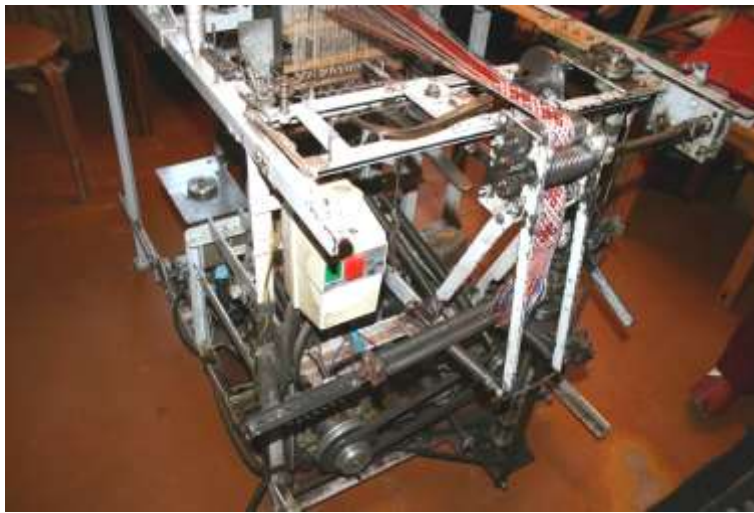

Vöökudumise masina
on ehitanud Viitina mees Raimond Pähn, millega on kootud üle 3000 vöö.
<http://www.maakodu.ee/print.php?page=23445&grupp=targutalita&artikkel=3090>
(01.05.2011)

Vöökudumine umbse ringina



Lõngad ja töövahendid enne ülesvedamist. Ülesveetud esimesed lõimed.



Ülesvedamine. Järgi jäänud materjal peale ülesvedamist. Töövahendid.

Vahelikupulgale (käärlaud omamata) võib umbse ringina rakendada ka nii:

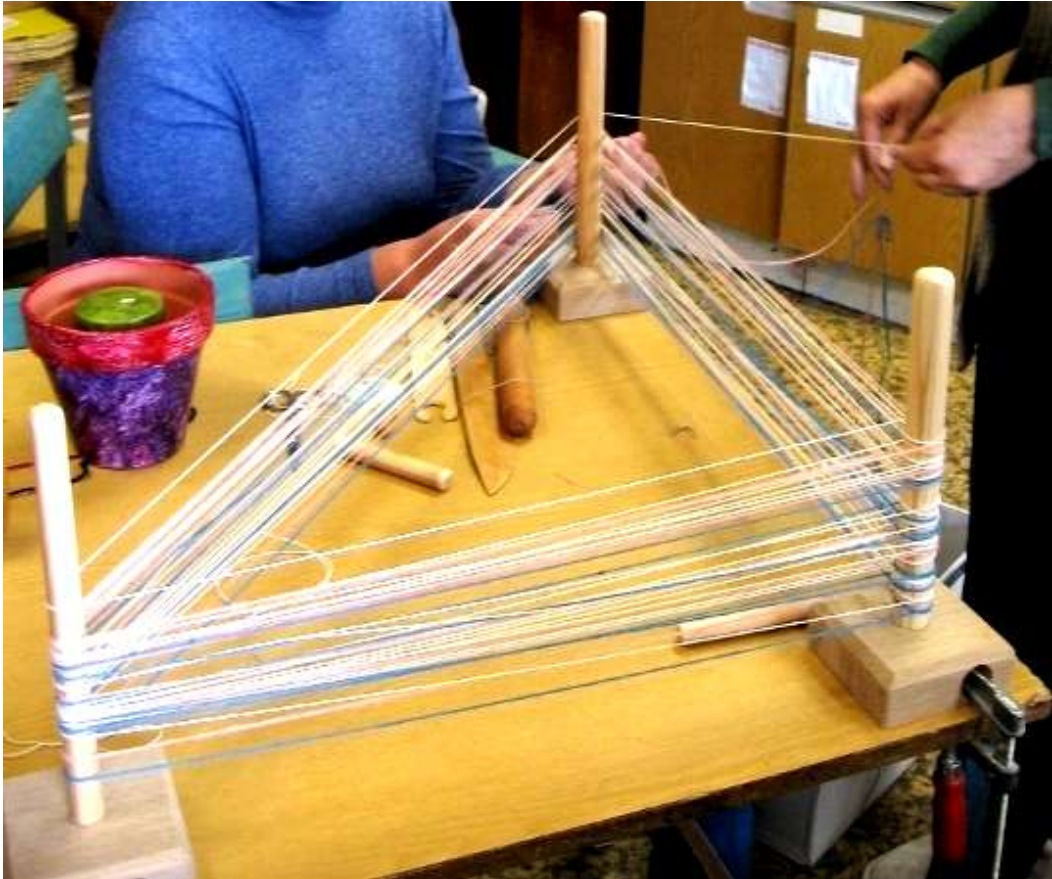

Kuduja istub umbse ringi sees.





Ülesveetud vöö.



Laud keeratud küljeli, et oleks kergem niitada.



Kootud vöö.



Lõpp ja algus koos.

Käärlaud

... on mugav abivahend kirivöö lõimede ülesvedamiseks. Valida saab mitme erineva lõimepikkuse vahel: 275 cm, 300 cm, 325 cm, 350 cm ja 375 cm.

Kirivöö jaoks vajalik vahelikupulk on koos lõimega raami küljest eemaldatav. Niied saab lisada juba raami peal selleks ettenähtud lisapulga abil. Lõngahoidik aitab säilitada ühtlast lõnga pinget ka siis, kui jätkad teise lõngaga. Raami üldpikkus 2 m.

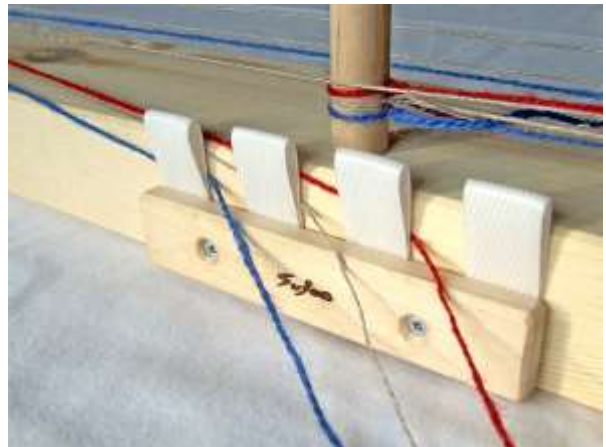
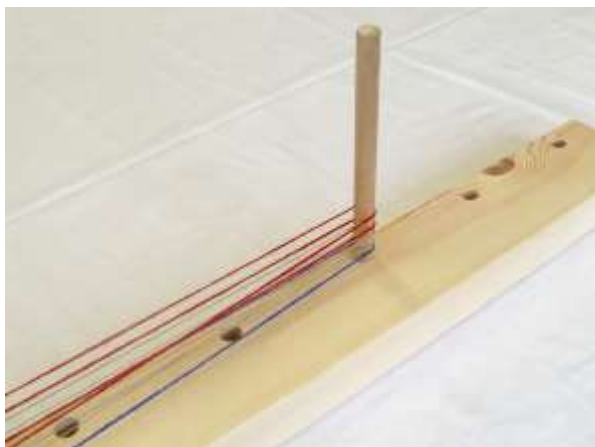

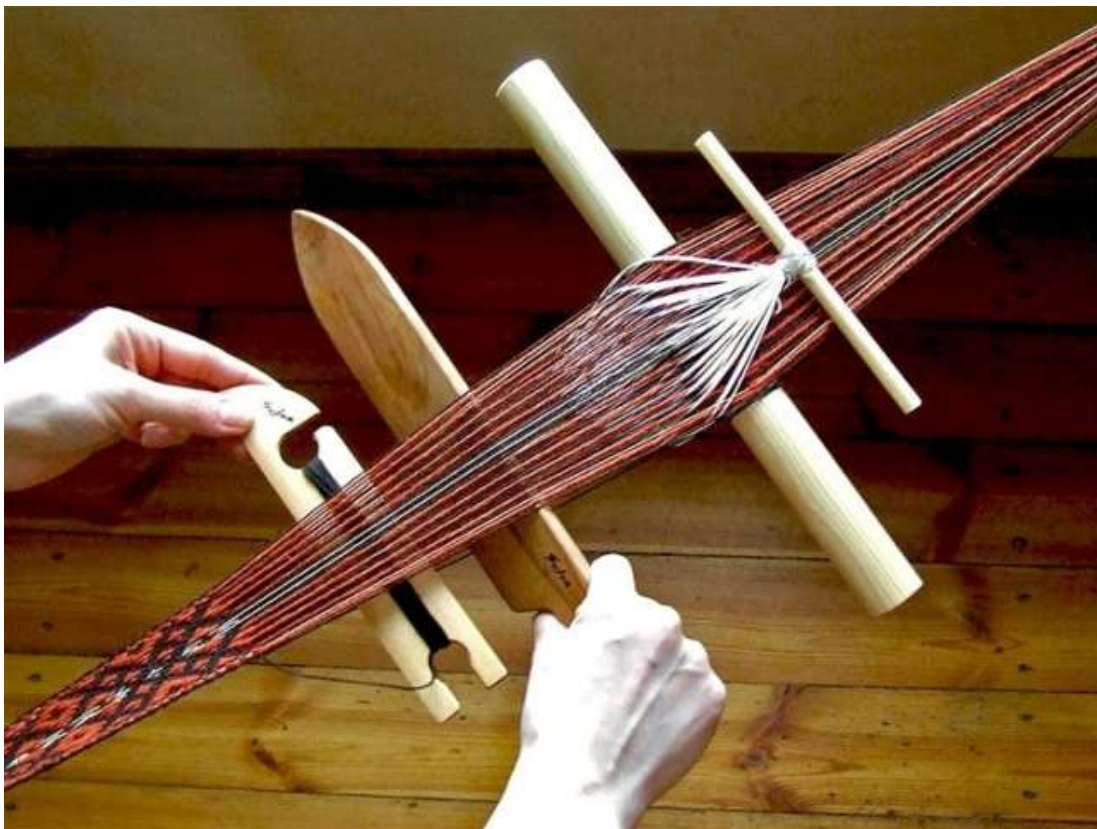
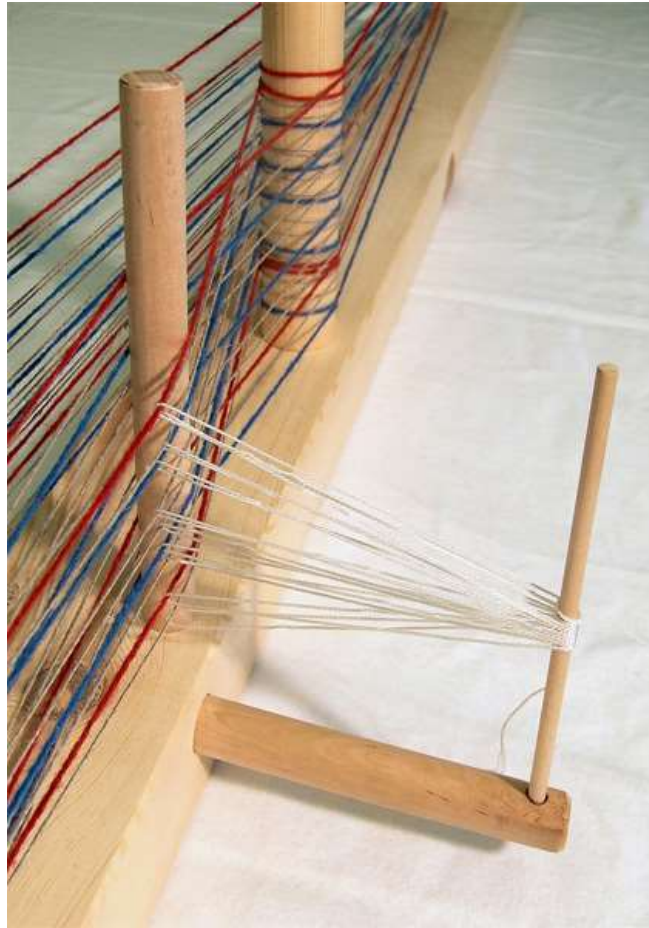

Kudumisraamiga kudumine



Võõ niiepaelte mõõtmise.



Valmis niied terve võõ jaoks.



Ülesveetud võõ võökudumisraamil.



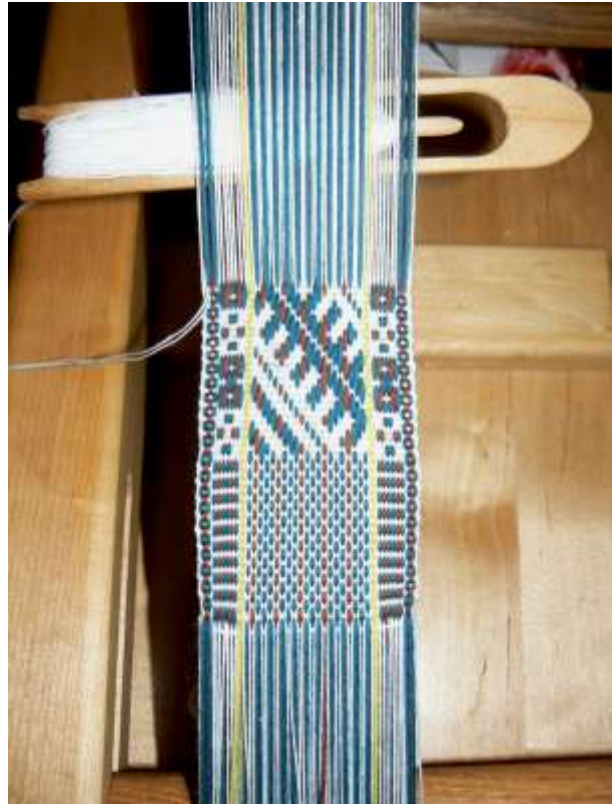

Vöökudumise algus. Vöö alguses 5 cm labast kudet, seejärel algab mustri korjamine

Tiia Artla ja Liivi Orav